

PROCEEDINGS

15th

**Göttingen Meeting
of the German
Neuroscience Society**

March 22–24, 2023

39th Göttingen Neurobiology Conference



NEUROWISSENSCHAFTLICHE
GESELLSCHAFT

GERMAN NEUROSCIENCE SOCIETY

This is a Supplement to
Neuroforum March 2023
VOLUME 29 ISSUE 1
e-ISSN 2363-7013
March 22–24, 2023

Index

[Plenary Lectures](#)

[Symposia](#)

[Poster Topics](#)

[Author Index](#)

Plenary Lectures

- [P1](#) Astroglia: from stars to brain plasticity
Nathalie Rouach
- [P2](#) Neural arithmetic
Lukas Groschner
- [P3](#) Holographic manipulation of neuronal circuits:^[*i*]circuit optogenetics^[/i*]
Valentina Emiliani
- [P4](#) Proteopathic seeds in neurodegenerative diseases
Mathias Jucker
- [P5](#) A neuroethological approach to the honeybee brain
Randolf Menzel
- [P6](#) Mind the gap! Super-resolution imaging of the extracellular space in the brain
Valentin Nägerl
- [P7](#) Translation in clinical neuroscience: a good story but not the end of the story
Peter Gaston Falkai
- [P8](#) Protein Transport from NMDA-receptors to the nucleus in health and disease
Michael R. Kreutz

Astroglia: from stars to brain plasticity

Nathalie Rouach¹

¹College de France, Center for Interdisciplinary Research in Biology, 11 place Marcelin Berthelot, 75005 Paris, France

Our laboratory investigates whether and how the underexplored astrocytes, which are the very abundant non-neuronal, but yet active cells of the brain, play a direct role in information processing. We particularly explore the molecular modalities and functional outcomes of astrocyte-neuron interactions in physiological and pathological contexts focusing *ex vivo* or *in vivo* on neuronal excitability, synaptic transmission, plasticity, synchronization and cognitive functions. To do so, we use a multidisciplinary approach combining electrophysiology, imaging, behavioral testing, mathematical modeling and molecular tools targeting selectively astrocytes *in situ* and *in vivo* in mice and human tissues. Using this strategy, we performed in the last years mostly fundamental research on role of astrocytes in synaptic transmission, plasticity and network activity in normal and pathological conditions. We uncovered several major astroglial properties regulating physiological and pathological neuronal activities. In particular, we have unraveled many ways the connexins control neuronal wiring and activity via regulation of the extracellular matrix, ion homeostasis, gliotransmitter release or astroglial synapse coverage. Our work thus fuels the emerging concept of neuroglial networks, in which astrocytes actively participate to the formation, activity and plasticity of local neuronal networks.

Neural arithmetic

Lukas Groschner¹

¹Max Planck Institute for Biological Intelligence, Circuits – Computation – Models, Am Klopferspitz 18, 82152 Martinsried, Germany

Nervous systems derive much of their computational power from the arithmetic operations performed in single nerve cells, but our understanding of these operations and of their biophysical implementations is scant. I pursue this problem in the brain of the fruit fly, where knowledge about synaptic connectivity is readily available and the activities of identified neurons can be recorded and controlled to make mechanistic ideas precise and testable. Focusing on well-defined computations in the olfactory and visual systems, my talk will provide a biophysical account of how individual neurons can approximate two basic arithmetic operations: addition and multiplication.

In a group of third-order olfactory neurons, the summation of synaptic signals over extended time periods relies on a particular ion-channel make up. Here, the forkhead box P transcription factor (FoxP) sets neuronal integration times and behavioural reaction times by controlling the expression of the voltage-gated potassium channel Shal. Targeted manipulations of FoxP and of Shal have predictable consequences on the integrative properties of the neurons and on the olfactory decision-making behaviour of the animal.

Multiplicative signal processing in the motion vision system, in contrast, does not depend on voltage-gated ion channels. It arises purely from the coincidence of excitation and release from shunting inhibition. In visual motion-sensing neurons, this passive mechanism of multiplicative disinhibition depends on the expression of the glutamate-gated chloride channel GluCl α . The presence of GluCl α sharpens the directional tuning of motion-sensing neurons and the optomotor acuity of the animal. Based on comprehensive recordings of dendritic input signals, I aim to provide an intuitive understanding of how a single nerve cell can multiply two synaptic signals—a computation implicated not only in motion vision, but in many brain processes including sound localization, navigation, and the gating of sensory afferents.



**NEURAL
ARITHMETIC**

Holographic manipulation of neuronal circuits: *circuit optogenetics*

Valentina Emiliani¹

¹Vision Institute, CNRS, INSERM, Sorbonne University, Photonics Department, Wave front engineering microscopy group, 13, Rue Moreau, 75014 Paris, France

The optogenetics revolution began with the discovery of microbial opsins and their sensitivity to light (1971-on), and continued with the demonstration of their utility and function in neuronal cells (2005-on). Light-induced conformational changes in opsins allow direct transduction of photonic energy into electrical currents, thereby activating or inhibiting neuronal signals in a non-invasive manner. Optogenetics has found use throughout neuroscience because it enables scientists to establish the role of specific cell types in the control of behaviors or pathologies. Most of these experiments have used relatively simple illumination methods, e.g. using visible light to illuminate large regions of the brain using genetic targeting strategies to 'isolate' a specific cell type. However, wide-field illumination can only synchronously activate entire populations of neurons, thereby controlling them as a whole – a highly unnaturalistic state, given that neurons fire in very complex patterns and sequences as they compute. Indeed, if one examines the activity of a neuronal circuit under physiological conditions, it is characterized in most cases by the fact that even genetically identical cells can have completely independent patterns of activity: each cell in the circuit has its own spatiotemporal signature. Mimicking and manipulating neuronal activity with this degree of precision therefore requires the development of new optical methods capable of illuminating one or more cells independently in space and time.

Here, we will review the most significant breakthroughs of the past years, which enable manipulating neuronal activity with this degree of precision, with particular emphasis on the most recent advances in what we named *circuit optogenetics*: a combination of wave front shaping approaches (including holographic light illumination, temporal focusing and holographic endoscopy), with opsins engineering and laser development enabling controlling single or multiple targets independently in space and time with single-neuron and single-spike precision, at large depths. We will show two examples where we have used *circuit optogenetics* for the investigation of intra-layers signal propagation in mouse retina and the in vivo high throughput connectivity mapping in mice visual cortex.

Proteopathic seeds in neurodegenerative diseases

Mathias Jucker^{1,2}

¹Hertie-Institute for Clinical Brain Research, University of Tübingen, Tübingen, Germany

²German Center for Neurodegenerative Diseases (DZNE), Tübingen, Germany

The commonality of many neurodegenerative disorders is the progressive temporal and spatial aggregation of specific proteins in the brain. The quintessential proteopathy is Alzheimer's disease (AD), in which the aggregation and seeded propagation of amyloid- β peptide ($A\beta$) triggers AD pathogenesis, including neuronal Tau inclusions and neurodegeneration. Current therapeutic strategies focus on early disease stages and aim to inactivate $A\beta$ seed propagation before the onset of neurodegeneration. However, to develop such primary prevention approaches a mechanistic understanding of early disease biomarkers is essential, as they are a prerequisite for monitoring therapeutic efficacy in a clinical setting.

A neuroethological approach to the honeybee brain

Randolf Menzel¹

¹Freie Universität Berlin, Department Biology-Neurobiology, Königin Luisenstr.1-3, 14195 Berlin, Germany

Neuroethologists derive their questions about the brain functions from observations of diverse animal species behaving under natural conditions. Neuroethological research provides us with a rich repertoire of wonderful examples of sensory-motor and cognitive adaptations to the species-specific ecological niche. Comparing different animal species with their ecological adaptations offers the unique opportunity to uncover general rules of brain function and possibly graded implementations according to phylogenetic relationships. Comparison across species, however, comes with the risk of generalizing concepts and terminology that are well-defined for one species but less or only speculatively transferred to another species. This is particularly a problem when terminology applied to human subjective experience is transferred to animals, but it is also a problem in any inter-species comparison. Another problem arises when molecular or cellular processes found to correlate with cognitive faculties in brains of humans and primates are used to argue in favor of similar cognitive capacities in frequently used model organisms. Thus neuroethological research faces the twin challenges of comparisons across species and the skepticism of one animal species being a “model” for another animals species or even humans.

I will discuss these challenges of the neuroethological approach for the honeybee. More than 100 years of intensive ethological studies under natural or semi-natural conditions provide us with a firm ground for the selection of study cases suitable for the search of neural processes. Neurobiological studies require laboratory conditions that only partially mimic natural conditions. The transfer from natural to laboratory conditions is not easy. Essential components of the behavior need to be identified that allow neural studies suitable for the selected species. My selection is based on the research of my group over a few decades. This will also give me the chance to contemplate on the more recent history of neuroscience in general, the great advances in neuroethology and some of the many open questions. The following examples will be illuminated from the behavioral and neural perspective: 1. The flower market and color vision, 2. Odor discrimination and odor coding, 3. Foraging strategy and memory dynamics, 4. Learning and neural plasticity, 5. Sleep and memory consolidation, 6. Extraction of a location in the map-like representation of explored landscape via the vector information transmitted in the bees` waggle dances and the search for neural correlates.

During these studies, we were and still are confronted by questions resulting from inter-species comparison. In which sense have honeybees expectations and plan their decisions accordingly? Is it helpful to use cognitive terms like wanting, being aggressive, frustrated, optimistic? Do they count and calculate? Does the use of such cognitive terms reach beyond metaphors? Symbolic communication in the social context by the waggle dance offers a unique avenue into mental operations of a small brain. I will argue that the symbolic form of communication via the waggle dance involves at the receiver`s side (the dance follower) the retrieval of a spatial memory in the form of a cognitive map. The related neural implementations are unknown, but hints exist where we should look for them in the bee brain.

Mind the gap! Super-resolution imaging of the extracellular space in the brain

Valentin Nägerl ¹

¹University of Bordeaux, Interdisciplinary Institute for Neuroscience , 146 Rue Léo Saignat, 33077 Bordeaux, France

Progress in microscopy technology has a long history of triggering major advances in neuroscience. Super-resolution microscopy, famous for shattering the diffraction barrier of light microscopy, is a case in point. It gives access to anatomical designs and dynamics of nano-structures, which are impossible to resolve using conventional light microscopy, from the elaborate anatomy of neurons and glial cells, to the organelles and molecules inside of them. Brain cells such as neurons and astrocytes exhibit an extremely elaborate morphology, and their functional specializations like synapses and glial processes often fall below the resolution limit of conventional light microscopy. This is a huge obstacle for neurobiologists because the nanoarchitecture critically shapes fundamental functions like synaptic transmission and Ca²⁺ signaling. Super-resolution microscopy can overcome this problem, offering the chance to visualize the structural and molecular organization of brain cells in a living and dynamic tissue context, unlike traditional methods like electron microscopy or atomic force microscopy.

Translation in clinical neuroscience: a good story but not the end of the story

Peter Gaston Falkai¹

¹Ludwig-Maximilians-University Munich, Psychiatric Department, Nußbaumstr. 7, 80336 Munich, Germany

Psychiatry has profited considerably by new developments in molecular biology and imaging over the last 20 years. Our knowledge about brain function and dysfunction has grown proportionally but very little from this knowledge is reaching clinical care. Therefore, agencies supporting research on severe mental disorders urge researchers to press for real translation in research from bench to bedside and include the relevant stakeholders into their research projects. Especially this last point would surely lead to more focus regarding the question of what kind of research is needed to improve clinical reality, since this clinical reality is not very positive for about half of the patients with schizophrenia, major depression or Bipolar disorder.

They are severe brain disorders characterised by positive, negative, affective and cognitive symptoms and can be viewed as disorders of impaired neural plasticity. They lead to life-long disability in approx. 50% of the sufferers and are still connected with an unfavourable outcome. Therefore, it is inevitable to find and apply targeted interventions to reduce the risk of psychosis and/or prevent a further chronification of the illness.

There are two major obstacles translational research on severe mental illness has to face. One is the introduction of easy to measure and reliable biomarkers. The second are mechanistically informed add-on treatments to improve the residual symptoms of these illnesses. To reach the first goal, subgroups must be identified utilising biomarkers in order to induce specifically targeted treatments. For the long-term prognosis and outcome it is necessary for biomarkers to constitute easy measurable clinical routine parameters.

Protein Transport from NMDA-receptors to the nucleus in health and disease

Michael R. Kreutz^{1,2}

¹Leibniz Institute for Neurobiology, RG Neuroplasticity, Magdeburg, Germany

²Leibniz Group 'Dendritic Organelles and Synaptic Function', ZMNH, University Medical Center Hamburg

The extreme length of neuronal processes poses a challenge for synapse-to-nucleus communication. In response to this challenge several different mechanisms have evolved in neurons to couple synaptic activity to the regulation of gene expression. One of these mechanisms concerns the long-distance trafficking of proteins from postsynaptic sites and here in particular NMDA-receptors to the nucleus. Protein transport from synapse-to-nucleus has been largely neglected but it has the potential to encode information about synaptic signals at the site of origin and to induce sustained changes in gene expression. I will summarize current evidence on mechanisms of transport and consequences of nuclear import of these proteins with special emphasis on a synapto-nuclear protein messenger called Jacob. Finally, I will discuss how long-distance communication via protein transport might allow for precise decoding of NMDA-receptor activity into specific gene transcription and translation.

Symposia

- [S1](#) Gut-brain signalling: from sensory cell biology to animal behaviour
- [S2](#) Novel functions and regulatory mechanisms of the neuronal actin cytoskeleton
- [S3](#) Developmental mechanisms regulating functional cortical networks
- [S4](#) Changing Memories
- [S5](#) How cellular clocks spanning multiple time scales orchestrate biological timing
- [S6](#) Cerebellum and mushroom body: common circuit motifs for learning and adaptive behaviour?
- [S7](#) Disease-specific autoantibodies against neuronal surface antigens disrupt synaptic function
- [S8](#) Molecular Mechanisms of Synaptic Brain Disorders
- [S9](#) New advances in the neuroscience underlying socio-emotional behaviour
- [S10](#) Membrane trafficking processes and presynaptic proteostasis
- [S11](#) Neuroscience of naturalistic navigation and foraging in non-human primates
- [S12](#) Epileptogenesis in mouse models of genetic epilepsies
- [S13](#) Breaking News
- [S14](#) Plasticity in unexpected places: flexible circuits for instinctive behaviours
- [S15](#) Breaking News
- [S16](#) A new look at neuronal circuits after CNS injury: mechanisms for vulnerability and repair
- [S17](#) Moving the body: communication, coordination and control in neuromechanical systems
- [S18](#) Astrocyte control of neural circuit function and animal behaviour
- [S19](#) Impact of early traumatic stress on brain development, and mental and somatic health

- [S20](#) Hidden senses
- [S21](#) Pushing and pulling: how the interplay of excitation and inhibition shapes network dynamics
- [S22](#) Illuminating the brain – current applications and future developments of next-generation biosensors
- [S23](#) Epigenomic adaptations in CNS development
- [S24](#) Inflammatory mechanisms of epileptogenesis
- [S25](#) A comparative perspective on social communication
- [S26](#) Phase separation in neuronal (patho)physiology
- [S27](#) From imprecision to robustness in neural circuit assembly
- [S28](#) Translational science in pediatric neurology – what we can learn!
- [S29](#) Brain dysfunction upon energy failure: new insights into the role of astrocytes
- [S30](#) Alternatives to living animal models
- [S31](#) Magnetoreception – the sixth sense
- [S32](#) Presynaptic calcium channels: key players in synaptic transmission and plasticity
- [S33](#) Bridging brain function and microglia signaling
- [S34](#) Novel insights into hypothalamic mechanisms for adaptive control of homeostasis
- [S35](#) Insights into the neural basis of cognition from human intracranial electrophysiology
- [S36](#) Transformations of visual representation from the retina to the cortex

Symposium

S1: Gut-brain signalling: from sensory cell biology to animal behaviour

- [S1-1](#) Trust your gut: an intestinal specialised epithelial sensory cell is looking out for you
Constanza Alcaino, Arnaldo Mercado-Perez, Kaitlyn Knutson, Sara Whiteman, Halil Kacmaz, Peter R Strege, Gianrico Farrugia, Frank Reimann, Fiona M Gribble, Arthur Beyder
- [S1-2](#) Signalling cross-talk between glucagon-like peptide-1 (GLP-1) releasing enteroendocrine cells and vagal afferent neurons
Van Lu
- [S1-3](#) Effects of diet and food-related olfactory cues on the activity of Insulin Producing Cells in *Drosophila*
Rituja Bisen, Hannah Soyka, Jan M. Ache
- [S1-4](#) Obesity-Mediated Dysfunction of Gut-Brain Dynamics
Lisa Rachel Beutler, Carolyn M Lorch, Jessica Xia, Nikolas W Hayes
- [S1-5](#) Gut signaling in the regulation of animal behavior
Kim Rewitz

Trust your gut: an intestinal specialised epithelial sensory cell is looking out for you

Constanza Alcaino¹, Arnaldo Mercado-Perez², Kaitlyn Knutson², Sara Whiteman², Halil Kacmaz², Peter R Strege², Gianrico Farrugia^{2,3}, Frank Reimann¹, Fiona M Gribble¹, Arthur Beyder^{2,3}

¹University of Cambridge, Wellcome-MRC Institute of Metabolic Science, Box 289 Addenbrookes Hospital, CB2 0QQ Cambridge, United Kingdom

²Enteric NeuroScience Program (ENSP), Division of Gastroenterology & Hepatology, Mayo Clinic, Rochester, MN, USA

³Department of Physiology and Biomedical Engineering, Mayo Clinic, Rochester, MN, USA

Enteroendocrine cells (EECs) of the gastrointestinal (GI) epithelium are important specialized sensors of luminal forces and chemicals, like nutrients and bacterial metabolites. EECs can regulate GI physiology by releasing important signaling molecules, such as serotonin (5-HT) and incretins. Recently, we showed that a population of EECs can sense mechanical forces by activation of the mechanosensitive ion channel Piezo2, which is responsible for the mechanosensitive ionic currents, intracellular Ca²⁺ increase, 5-HT release, epithelial secretion, and colonic motility. However, the signal transduction mechanisms that follow EEC mechanical activation downstream of Piezo2 remain unknown. Studies on EEC chemosensitivity have shown that EEC chemotransduction relies on the activation of the voltage-gated Ca²⁺ channels (CaVs) L-, P/Q-, but not T-type. These studies have also suggested certain types of metabolites, such as the olfactory receptor agonist isovalerate, can increase mechanically induced colonic hypersensitivity, and P/Q-type CaVs have been involved in this signaling pathway. T-type CaVs are involved in pain sensitivity in the dorsal root ganglia, where they act as signal amplifiers of nociceptive signals. T-type CaVs are highly expressed in EECs, but their role is unknown. The aim of this study is to determine the role of T-type CaVs in EEC mechanotransduction. To achieve this, we developed intestinal organoids from human (Tph1-venus using CRSPR-Cas9) and transgenic mouse tissue (NeuroD1-tdTomato/GCAMP5G and Cav3.2-tdTomato) for in vitro experiments (RNAseq, IHC, electrophysiology, Ca²⁺ imaging and 5-HT secretion), as well as ex-vivo and in vivo assays (Ussing chamber, bead expulsion and balloon distension) using a NeuroD1-cre/Cav3.2KO model. Our results show that human Tph1-venus+ cells have specific enrichment of CaVs: CACNA1A (P/Q-type), CACNA1H (T-type) and CACNA1D (L-type). 5-HT secretion and [Ca²⁺]_i responses can be modulated by isovalerate, acetate, cinnamaldehyde, tryptophan, INSL5 and Noradrenaline. Electrical excitability of these human Tph1+ cells can also be pharmacologically modulated. In mouse NeuroD1-tdTomato/GCAMP5G cells, we also found enrichment of CaV subunits and IHC showed Cav3.2 (T-type) specifically within NeuroD1 EECs. Electrophysiology revealed a rapidly activating and inactivating voltage-dependent Ca²⁺ current that was blocked by T-type CaV blockers. [Ca²⁺]_i responses to mechanical stimulation were inhibited by extracellular Ca²⁺ substitution, non-selective CaV block, P/Q-type CaV block, T-type knockdown, but not L-type CaV block. Ussing chamber experiments revealed NeuroD1-cre/Cav3.2KO mice have reduced pressure-induced secretion, whereas our in vivo assays suggest that NeuroD1-cre/Cav3.2KO mice have slower colonic transit and lower pain responses, suggesting this ion channel is not only important in mechanotransduction, but could be critical to the recently found role of EECs in visceral hypersensitivity. Our work suggests the role of EECs as specialized sensors does not limit

to merely communicating with enteric neurons, but that they set the tone for the mechanical and chemically sensitive environment of the gut in normal physiology and in abnormal conditions like those found in inflammatory bowel syndrome. Our findings provide insights into potential modulation of EECs to control pain in patients with visceral hypersensitivity and other disorders.

Signalling cross-talk between glucagon-like peptide-1 (GLP-1) releasing enteroendocrine cells and vagal afferent neurons

Van Lu¹

¹Department of Physiology and Pharmacology, University of Western Ontario, London, Ontario, Canada, N6A 5C1

Enteroendocrine cells (EECs) are specialized intestinal sensory cells that respond to a wide range of ingested nutrients by releasing hormones and other chemical transmitters. One hormone released from EECs, glucagon-like peptide-1 (GLP-1), has been shown to regulate glucose homeostasis and inhibit food intake. The neuronal network linking the gut microenvironment to feeding behaviour involves vagal afferent neurons expressing receptors activated by GLP-1. Using chemogenetic tools and co-cultures of the “gut-brain-axis”, we were able to demonstrate a role of adenosine triphosphate (ATP) as a co-activator of vagal afferent neurons during EEC stimulation. Furthermore, we reduced mesenteric nerve activity in an intact gut preparation with blockers of purinergic receptors during selective stimulation of EECs. We have also investigated the role of other potential co-transmitters such as glutamate on vagal afferent activity. Recently, we have also begun to investigate reciprocal modulation of EEC activity by vagal afferent transmitters, specifically Substance P and acetylcholine.

These studies describe the initial chemical signalling events from sensory EECs to local neurons. These details will be vital in fully elucidating gut-brain signalling mechanisms and understanding the role of nutrients and the gut microbiota in regulating mood and behaviour.

Effects of diet and food-related olfactory cues on the activity of Insulin Producing Cells in *Drosophila*

Rituja Bisen, Hannah Soyka¹, Jan M. Ache¹

¹Neurobiology and Genetics, Theodor-Boveri-Institute, Biocenter, Julius-Maximilians-University of Würzburg, Würzburg, Germany

Insulin signaling plays a key role in controlling metabolic homeostasis and is heavily implicated in processes underlying reproduction, aging and stress resistance. Insulin producing cells (IPCs) in *Drosophila* are functional analogues to mammalian pancreatic beta cells and produce different *Drosophila* insulin like peptides (DILPs) during different stages of a fly's lifespan. In the adult fly, release of these DILPs is dependent on nutrient availability. Thus, nutrient sensing is vital for metabolic homeostasis. Fuel substrates such as glucose serve immediate energy demanding processes such as locomotion, grooming, and courtship. IPCs are hypothesized to sense hemolymph glucose levels cell-autonomously. Here, we set out to perform an *in-vivo* electrophysiological characterization of nutrient sensing in *Drosophila* IPCs.

To label IPCs for patch-clamp recordings, we used a Dilp2-Gal4 driver line to express GFP in IPCs of the adult *Drosophila* brain. Using these flies, we performed targeted *in-vivo* patch-clamp recordings from IPCs while perfusing the brain with artificial hemolymph containing different concentrations of glucose. Furthermore, we compared the effects of high glucose versus high protein diets on IPC activity. Since our approach permitted the quantification of rapid changes in IPC activity owing to the high temporal resolution of electrophysiological recordings, we also tested whether food-related olfactory cues modulated IPC activity. For instance, we asked whether appetitive food odors induced increases in IPC activity as an anticipatory response to prepare the fly for food ingestion.

As expected, the nutritional state strongly modulated IPC activity. IPCs were basically quiescent in 24-hour starved flies, while they were firing at about 1 Hz in flies fed ad libitum. Interestingly, while changes in the IPC activity remained negligible when we perfused high-glucose saline over the brain of starved flies, re-feeding flies with a high-glucose diet strongly increased IPC activity. This was reminiscent of the incretin-effect described in humans and other mammals, where the ingestion of glucose leads to a significantly higher release of insulin as compared to intravenous application of glucose. In mammals, this 'incretin-effect' is driven by the secretion of incretin hormones from the gut after glucose ingestion. High protein diet failed to increase IPC activity upon refeeding, suggesting that the heightened IPC activity after re-feeding was glucose-specific, just like the incretin-effect.

Next, we tested whether IPCs responded to appetitive food odors, which signal the presence of a food source and thus an increased likelihood for subsequent food intake. Indeed, our results showed that appetitive olfactory cues caused an increase in IPC activity in starved flies, suggesting that IPC activity is modulated in a predictive fashion.

In conclusion, our results show that glucose-feeding and food-related odors regulate IPC activity in a nutrition-dependent manner, since an increase in IPC spike rate was only observed in starved flies. The increase in IPC activity in both cases underlines that IPCs are part of a modulatory network that integrates internal state changes and food-related sensory cues to maintain nutrient homeostasis.

Obesity-Mediated Dysfunction of Gut-Brain Dynamics

Lisa Rachel Beutler¹, Carolyn M Lorch², Jessica Xia³, Nikolas W Hayes⁴

¹Northwestern University Feinberg School of Medicine, Department of Medicine

²Driskill Graduate Program, Northwestern University

³Neuroscience, Northwestern University

⁴Northwestern University Interdepartmental Neuroscience Graduate Program, Northwestern University

Excessive refined carbohydrate intake, particularly of sugar-sweetened beverages, is a key driver of the diabetes and obesity epidemics. However, little is known about the effect of carbohydrate over-consumption on the neural circuits that regulate energy and glucose homeostasis. In exciting recent studies, I used in vivo calcium imaging to show that a high-fat diet (HFD) persistently dampens the activity of the gut-brain circuits that control appetite. Remarkably, the effects were macronutrient specific; neural responses to dietary fat and lipid-stimulated hormone release were selectively blunted in HFD-fed mice. My lab has now developed a novel sucrose over-consumption paradigm that we have combined with calcium imaging to understand how high-sugar diets (HSD) alter the central response to satiating signals. Our data show that HSD and HFD have both similar and distinct effects on gut-brain circuits. By revealing in unprecedented detail how diet contributes to diabetes and obesity via altered gut-brain communication, our lab's work will inform the development of novel circuit-targeted therapies for these metabolic disorders.

Gut signaling in the regulation of animal behavior

Kim Rewitz¹

¹University of Copenhagen, Biology, Universitetsparken 15, 2100 Copenhagen, Denmark

In animals, feeding and sleep behaviors are intimately linked to nutrition. Animals adapt their feeding and sleep behaviors according to their internal needs to ensure homeostasis. Although the gastrointestinal tract mediates many effects of nutrition on behaviors and metabolism, the underlying mechanisms are poorly defined. The gut is the largest endocrine organ and secretes a variety of hormones from enteroendocrine cells (EECs) that sense ingested nutrients. These gut hormones signal to the brain and other organs to regulate behavior and metabolism. To identify the mechanisms by which the gut senses nutrition and stress, we performed a large-scale multi-dimensional in vivo EEC-specific RNAi screen for hormonal factors, nutrient transporters, and receptors that regulate behavior, metabolism, and stress responses. Based on this comprehensive data set, we are exploring how the gut processes nutritional information and investigating the gut hormones that mediate inter-organ crosstalk controlling homeostatically regulated behaviors and metabolism. We identified an array of gut hormones and nutrient-sensing mechanisms that affect sleep and feeding behaviors. Our study provides the basis for understanding how the gut controls behaviors that are essential for energy homeostasis and overall human health.

Symposium

S2: Novel functions and regulatory mechanisms of the neuronal actin cytoskeleton

- [S2-1](#) Cytoskeletal makeup of the synapse: shaft versus spine
Marina Mikhaylova, Nathalie Hertrich, Anja Konietzny, Bas van Bommel, Tomas Fanutza
- [S2-2](#) CAP2 at the crossroads of Alzheimer's Disease pathogenesis pathways
Elena Marcello
- [S2-3](#) CAP1 and cofilin1: an intimate duet that governs neuronal actin dynamics
Marco Rust, Anika Heinze, Felix Schneider, Cara Schuldt, Sharof Khudayberdiev, Thuy-An Duong, Isabell Metz, Bas van Bommel, Daniela Hacker, Ramona Stringhi, Elena Marcello, Marina Mikhaylova
- [S2-4](#) Novel approach to analyze interactions of neighbouring spines
Kristina Ponimaskine, Christian Schulze, Thomas Oertner

Cytoskeletal makeup of the synapse: shaft versus spine

Marina Mikhaylova¹, Nathalie Hertrich¹, Anja Konietzny¹, Bas van Bommel¹, Tomas Fanutza¹

¹Institute of Biology, AG Optobiology, Invalidenstr. 42, 10115 Berlin, Germany

The ability of neurons to communicate and store information depends on the activity of synapses which can be located on small protrusions (dendritic spines) or directly on the dendritic shaft. The formation, plasticity and stability of synapses are regulated by the neuronal cytoskeleton. Actin filaments together with microtubules orchestrate the structural organization of both shaft and spine synapses, enabling their efficacy in response to synaptic activation. Synapses critically depend on several factors, which are also mediated by the cytoskeleton, including transport and delivery of proteins from the soma, protein synthesis, as well as surface diffusion of membrane proteins or protein removal. In this talk we discuss the differences and similarities between synapses located in the spines versus dendritic shaft.

CAP2 at the crossroads of Alzheimer's Disease pathogenesis pathways

Elena Marcello¹

¹University of Milan, Department of Pharmacological and Biomolecular Sciences, Via Balzaretti 9, 20133 Milan, Italy

Synaptic loss and cytoskeletal abnormalities, such as cofilin-actin rods, are biological hallmarks of Alzheimer's disease (AD). Rods are aggregates consisting mainly of actin and cofilin and are formed upon exposure to different stressors to transiently protect cells under unfavorable conditions. Cofilin-actin rods were found in AD patients and their formation is associated to exposure to Amyloid- β (A β) peptide, the main driver of AD pathogenesis. Neuronal cytoplasmic rods accumulate within neurites where they disrupt synaptic function and are a likely cause of synaptic loss without cell death, as occurs early in AD.

We have recently demonstrated that the actin-binding protein CAP2 (cyclase-associated protein 2) is a master regulator of cofilin in the synapse. The formation of CAP2 dimers can control cofilin synaptic availability in long-term potentiation processes that are crucial for stabilizing memory. Remarkably, CAP2 is down-regulated in AD and the reduced CAP2 availability impairs CAP2/cofilin association.

Considering these results, we investigated CAP2 role in the generation of cofilin-actin rods in AD.

Taking advantage of 3D confocal analysis, we found that CAP2 accumulates in actin rods, when neurons were specifically exposed to A β oligomers and not to another stressor. Short-term A β oligomers exposure triggers the removal of CAP2 and cofilin from the postsynaptic site. After the long-term exposure to A β oligomers, that induces synaptic loss and actin rods formation, cofilin is still reduced and CAP2 dimerization impaired in the synapses. Therefore, A β oligomers can profoundly affect CAP2/cofilin pathway that is required for the plasticity-induced remodelling of synapses. To prove that CAP2 is a key element in cofilin-actin rods formation in AD, we tested the effects of CAP2 overexpression. In hippocampal neuronal cultures, CAP2 overexpression prevents cofilin-actin rods formation and synapses loss induced by A β oligomers. In a mouse model of AD, we used a viral approach to overexpress CAP2 in the hippocampus before the onset of the pathology. The analysis of the hippocampal region revealed that CAP2 overexpression significantly reduces cofilin-actin rods formation at early stages of AD.

Overall, our data support the involvement of cofilin/CAP2 pathway in the generation of cytoskeleton abnormalities that can affect synaptic function in AD. As an early event in the neurodegenerative cascade, cofilin/CAP2 pathway is an ideal target for therapeutic intervention that might be useful in treatment of AD synaptic failure.

CAP1 and cofilin1: an intimate duet that governs neuronal actin dynamics

Marco Rust¹, Anika Heinze¹, Felix Schneider¹, Cara Schuldt¹, Sharof Khudayberdiev¹, Thuy-An Duong¹, Isabell Metz¹, Bas van Bommel^{2,3}, Daniela Hacker^{2,3}, Ramona Stringhi⁴, Elena Marcello⁴, Marina Mikhaylova^{2,3}

¹Molecular Neurobiology Group, University of Marburg, Germany; ²Optobiology Group, Institute of Biology, Humboldt-University Berlin, Germany, ³Neuronal Protein Transport Group, Center for Molecular Neurobiology (ZMNH), University of Hamburg, Germany; ⁴Department of Pharmacological and Biomolecular Sciences, University of Milan, Italy

Cyclase-associated proteins (CAP) are evolutionary conserved actin-binding proteins (ABP). In vitro studies of the past few years unraveled important functions for CAP in actin treadmilling, as they demonstrated that it accelerates both dissociation of actin subunits from filamentous actin (F-actin) and nucleotide exchange on actin monomers. Mammals express two CAP family members, namely CAP1 and CAP2. Analyses of systemic knockout (KO) mice by us and others unraveled important functions for CAP2 in heart physiology and myofibril differentiation during skeletal muscle development. Instead, due to the lack of appropriate mouse models, the physiological functions of CAP1 in mammals largely remained unknown. We have generated a conditional KO mouse model for CAP1 to study its function in the brain. Brain-specific CAP1-KO mice displayed a defect in neuron connectivity, while other important aspects of brain development were not affected. Impaired neuron connectivity was caused by delayed neuron differentiation, which we demonstrated for hippocampal neurons isolated from CAP1-KO mice. Mechanistically, we found that CAP1 controlled actin turnover and F-actin dynamics during neuron differentiation and that it cooperated with the key actin regulator cofilin1. Moreover, rescue experiments in double KO neurons lacking CAP1 and cofilin1 revealed mutual functional dependence of both ABP in neuronal actin dynamics and neuron differentiation. Further, we found that CAP1 was relevant for actin regulation not only during neuron differentiation, but also in dendritic spines, the postsynaptic compartment of most excitatory synapses in the vertebrate brain. Consequently, CAP1 inactivation altered dendritic spine density and morphology as well as synaptic function in hippocampal neurons. We showed that CAP1 cooperated with cofilin1 in actin regulation in dendritic spines and that both ABP were functionally dependent on each other at synapses. Together, we identified CAP1 as a crucial regulator for neuron differentiation and synaptic function, and we provide strong evidence for the conclusion that CAP1 and cofilin1 form an intimate duet that governs neuronal actin dynamics.

Novel approach to analyze interactions of neighbouring spines

Kristina Ponimaskine, Christian Schulze¹, Thomas Oertner¹

¹Center for Molecular Neurobiology Hamburg (ZMNH) , Institute of Synaptic Physiology, Falkenried 94, 20251 Hamburg, Germany

The formation and elimination of dendritic spines play an important role in structural remodeling of neuronal networks. This process is highly dynamic and occurs over different timescales. To close the observation gap between short-term plastic events (ranging from minutes to hours) and long-term effects (several hours to days) we engineered a novel on stage microscope-incubator optimized for long-term culturing and imaging of organotypic hippocampal slice cultures. Using this setup, we visualized excitatory and inhibitory spines in CA1 neurons over long time periods with the aid of fluorescently labelled recombinant intrabodies. These transcriptionally regulated intrabodies were designed to label endogenous PSD-95 and Gephyrin. To analyze the dynamics and interactions of excitatory and inhibitory spines, we developed a novel automated image analysis workflow, to first process and optimize large 3D multi-view image stacks for subsequent automated spine detection and tracking.

Our initial results demonstrate that this refined method allows to perform a detailed analysis of neighboring spine dynamics and their localization along the dendritic arbor as well as large-scale analysis with high temporal and spatial resolution. Moreover, this approach can be easily combined with (opto-)genetics and/or pharmacological manipulations.

Symposium

S3: Developmental mechanisms regulating functional cortical networks

[S3-1](#) Repurposed cells of development in the adult brain
Zoltan Molnar

[S3-2](#) Revealing molecular mechanisms of environmental impacts on neocortical development using human brain organoids
Simone Mayer

[S3-3](#) Dentate Granule Neuron Development as a Model for Autism Spectrum Disorder Due to Pten Loss
Bryan Weston Luikart

[S3-4](#) Chemogenetic modulation of activity shapes differentiation of cortical neurons
Ina Köhler, Lisa Marie Rennau, Max Schröder, Adriana Rehm, Lukas Cronin, Alexander Jack, Petra Wahle

[S3-5](#) The electrophysiology of Pten-Layer 6b conditional knockout mice
Timothy Zolnik, Aasha Meenakshisundaram, Matthew Larkum, Zoltan Molnar, Britta Eickholt

Repurposed cells of development in the adult brain

Zoltan Molnar¹

¹University of Oxford, Physiology, Anatomy and Genetics, Sherrington Building, Parks Road , OX1 3PT Oxford, United Kingdom

The lowermost cell layer of the adult cerebral cortex that contains interstitial white matter cells in humans and layer 6b in rodent. These cells are the remnants of the subplate cells that are present in large numbers and play key role in the formation of cortical circuits but a large fraction of them die during postnatal development. The adult population that remains in all mammals and display unique conserved gene expression and connectivity. These neurons are very abundant during development and express higher proportions of susceptibility genes linked to human cognitive disorders than any other cortical layer and their distribution is known to be altered in schizophrenia and autism (Hoerder-Suabedissen et al., 2013; Bakken et al., 2016; Molnár et al., 2020). In spite of these clinical links, our current knowledge on these neurons is limited.

We study their input and output using combined anatomical, genetic and physiological approaches. Selected cortical areas, relevant for sensory perception, arousal and sleep (V1, S1, M1, prefrontal cortex) are studied using chemogenetic and optogenetic methods.

Members of my laboratory identified intracortical and thalamic projections from a subpopulation of layer 6b cells that might regulate both cortical and thalamic arousal of cortical areas that are involved in higher cortical functions (Hoerder-Suabedissen, et al., 2018).

Our results suggest that 6b is not just a developmental remnant cell population in the adult, but a layer that plays a key role in cortical state control, integrating and modulating information processing (Guidi et al., 2016; Horvath et al., 2022).

Hoerder-Suabedissen et al., (2013) Proc Natl Acad Sci U S A. 110(9):3555-60.

Bakken et al., (2016) Nature. 535(7612):367-75.

Hoerder-Suabedissen et al., (2018) Cer Cortex. 2018 28(5):1882-97.

Guidi et al., (2016) SFN Abstract 634.16.

Molnár et al., (2020) Science, 370, eabb2153

Horvath et al., (2022) Body, Brain, Behavior - Elsevier, isbn:9780128180938.

Supported by MRC (MR/N026039/1) and Einstein Stiftung

Revealing molecular mechanisms of environmental impacts on neocortical development using human brain organoids

Simone Mayer¹

¹Hertie Institute for Clinical Brain Research, Molecular Brain Development, Otfried-Müller-Strasse 27, 72076 Tübingen, Germany

Over the last decades, it has been appreciated that human fetal brain development is shaped by environmental factors, and multiple epidemiological studies have shown the correlation between maternal health and fetal neurodevelopmental outcomes. At the same time, we have started to understand cellular trajectories in neocortical development at single-cell resolution. Applying single-cell read-outs to rodent models of prenatal environmental exposures has shed light on the possible cellular and molecular abnormalities driving neurodevelopmental disorders. However, in comparison to mouse, humans have a longer period of in utero neocortical development and can, therefore, be more vulnerable to environmental perturbations. The recent advent of complex in vitro models of human brain development including organoids has made long-term perturbation studies of human neocortical development and analysis at the cellular and molecular level possible. In order to reveal how environmental factors affect human neocortical development, we are exposing forebrain organoids to molecular mediators of environmental impacts and analyze effects at the cellular and molecular level using an array of readouts including single-cell transcriptomics. Specifically, we are interested in maternal immune activation, since it is a final common pathway through which many environmental impacts such as maternal infection, obesity, or psychiatric illness, affect the developing fetal brain and lead to increased risk in neurodevelopmental disorders. We have found shared and distinct cellular and molecular responses to maternal immune activation in human brain organoids compared to rodents. Our insights pave the way for understanding how maternal immune activation shapes fetal brain development in a species-specific manner.

Dentate Granule Neuron Development as a Model for Autism Spectrum Disorder Due to Pten Loss

Bryan Weston Luikart¹

¹Geisel School of Medicine at Dartmouth, Department of Molecular and Systems Biology, 74 College Street, Vail 604, 03756 Hanover, USA

Dentate gyrus granule neurons are among the latest developing neurons in the brain. The peak of granule neuron generation occurs during the first postnatal week of mouse development. Retroviruses reverse transcribe their genome into mitotic cells during the breakdown of their nuclear envelope - allowing for specific genetic access to granule neurons in the post-natal mouse brain. Using a combination of postnatal retrovirus injections and mouse genetics we have defined how Pten loss-of-function effects the development of neuronal morphology, synaptic connectivity, and excitability in vivo. Pten knockout results in increased downstream activation of mTORC1 to facilitate protein and lipid synthesis. Pharmacological or genetic inhibition of mTORC1 normalizes growth and synapse formation of Pten knockout neurons to wild-type levels. However, loss of mTORC1 does not rescue some alterations of excitability in Pten knockout neurons. We are currently uncovering the mechanisms underlying this mTORC1-independent effect on neuronal activity.

Chemogenetic modulation of activity shapes differentiation of cortical neurons

Ina Köhler, Lisa Marie Rennau¹, Max Schröder¹, Adriana Rehm¹, Lukas Cronin¹,
Alexander Jack¹, Petra Wahle¹

¹Ruhr-University Bochum, Developmental Neurobiology, Faculty of Biology and Biotechnology, Universitätsstraße 150, 44801 Bochum, Germany

Electrical activity is considered as a key driver for the neurochemical and morphological maturation of neurons and the formation of neuronal networks. Designer receptors exclusively activated by designer drugs (DREADDs) are chemogenetic tools for controlling neuronal activity at the single cell level by triggering specific G protein signaling. Our objective was to investigate if inhibitory hM4Di and excitatory hM3Dq are sufficient to shape dendritic and axonal differentiation in cortical neurons. hM4Di couples to G_{i/o} signaling and evokes hyperpolarization via GIRK channels. In contrast, activation of G_q coupled hM3Dq leads to depolarization through increased intracellular Ca²⁺ levels. DREADDs were biolistically transfected into neurons in organotypic slice cultures of rat visual cortex, and activated by clozapine-N-oxide (CNO) dissolved in H₂O. DREADDs were stably expressed and functional in immature cortical neurons. Neurons were analyzed after treatment for two postnatal time periods, DIV 5-10 and 10-20. We found that G protein coupled signaling modulates differentiation of apical dendrites of L2/3 pyramidal cells until DIV 10 and of L5/6 pyramidal cells from DIV 10 to 20. Further, the formation of horizontal collateral and bouton terminaux of CNO-stimulated pyramidal cell axons was strongly modulated by increasing or dampening activity. Also, the axonal differentiation regarding the number of bouton terminaux of basket cells is altered by DREADD activation. We show that DREADDs are a tool to precisely modulate activity in single cells in a wild-type network. Our findings add to the view that activity is a key driver in particular of postnatal L2/3 pyramidal cell maturation. Our results further suggest that inhibitory and excitatory G-protein signaling may represent two sides of a balanced system which activity-dependently shapes dendrites and axons in the developing cortex.

The electrophysiology of Pten-Layer 6b conditional knockout mice

Timothy Zolnik¹, Aasha Meenakshisundaram¹, Matthew Larkum², Zoltan Molnar³, Britta Eickholt¹

¹Charité University of Medicine, Berlin, Germany

²Humboldt University, Berlin, Germany

³Oxford University, Oxford, England

Layer 6b (L6b) is the deepest and most mysterious layer of the cortex and is thought to play a central role in several cognitive functions. L6b expresses Pten, an enzyme that when lacking leads to cognitive malfunctions including autism. Despite the links among Pten, L6b, and cognitive disorders, it remains unknown whether Pten regulates L6b. Here, we used optogenetics and patch-clamp recordings *ex vivo* to examine the anatomy and physiology of an important L6b subpopulation (L6b-Drd1) with conditional knockout of Pten. We found that loss of Pten in L6b-Drd1 neurons caused a significant increase in their number as well as an enlargement and increase in the complexity of their dendrites. Moreover, Pten-deficient L6b-Drd1 neurons fired spikes at much higher frequencies than controls, and their synaptic output dynamics and strength were significantly altered. Our results show that Pten plays a critical role in establishing L6b neurons and networks, suggesting that L6b and Pten may be important partners behind cognitive disorders such as autism.

Symposium

S4: Changing Memories

- [S4-1](#) Recovery of a forgotten memory in *Drosophila*
Wenbin Yang, Johannes Felsenberg

- [S4-2](#) Rescue of relearning induced reconsolidation impairments in instrumental learning tasks
Anni Richter

- [S4-3](#) Changing extinction memories with stress hormones
Christian J. Merz

- [S4-4](#) Memory retrieval facilitates suppression and reconsolidation update at different temporal scales
Daniela Schiller, Ye Wang, Jian Li, Ofer Perl, Ilan Harpaz-Rotem

- [S4-5](#) Targeting emotional episodic memory reconsolidation in humans
Bryan Strange

Recovery of a forgotten memory in *Drosophila*

Wenbin Yang, Johannes Felsenberg²

¹FMI Basel, Felsenberg Lab, Erlenmattstr. 71, 4058 Basel, Switzerland

Learned information can be forgotten. Encountering related cues, however, can reinstate the forgotten memory. How this change in accessibility of memory traces is achieved, is not understood. We developed a new paradigm to investigate the neuronal circuit mechanisms that underlie the recovery of forgotten memory in the fruit fly *Drosophila melanogaster*. Re-exposing flies to training-related reminder cues recovers forgotten aversive memories. In this process, the presence of contextual information that matches the learning situation seems to be crucial. Addressing the circuits that underlie this process reveals that output from two different olfactory centers, the lateral horn and the mushroom body, seem to recruit a single pair of dopamine neurons to recover forgotten memory. The capacity of these two dopamine neurons to re-install learned avoidance seems to depend on odor-specific plasticity established during initial learning. This is in line with the finding that the identified dopamine pathway is known to strengthen learning in repeated experiences but not in initial training trials. Comparing the recovered memory with the initial memory reveals differences in strength and retrieval circuitry, suggesting that the recovery process can implement changes in the stored information. Indeed, we find evidence that changing the reminder settings has a direct impact on the expression and the valence of the recovered memory. Based on these findings I will argue that recovering forgotten memories is a dopamine-driven process with the potential to change the recovered memory.

Rescue of relearning induced reconsolidation impairments in instrumental learning tasks

Anni Richter¹

¹Leibniz Institute for Neurobiology, Department of Behavioral Neurology, Brennekestr. 6, 39118 Magdeburg, Germany

After initial encoding, memory contents are formed - a process called consolidation. The view that memory consolidation occurs only once and that consolidated memories are stable and resistant to changes has been challenged by findings suggesting that memories are rewritten with each act of remembering. Neurobiological and neuropsychological studies have shown that memory may re-enter a transiently unstable state after its reactivation, thus requiring another phase of stabilization - called reconsolidation. Studies showing that reactivated memory content, just like new memory content, requires protein synthesis to be consolidated support the reconsolidation hypothesis, as do studies showing that pharmacological and behavioral manipulations following reactivation can influence what was previously learned. With my talk in the "Changing Memories" symposium, I will provide an overview on our current understanding of reconsolidation processes and show how induced reconsolidation impairments in humans may be rescued in an instrumental learning task.

Changing extinction memories with stress hormones

Christian J. Merz¹

¹Ruhr University Bochum, Cognitive Psychology, Universitätsstr. 150, 44780 Bochum, Germany

The stress hormone cortisol crucially changes episodic learning and memory processes. On one side, cortisol impairs memory retrieval, on the other side, cortisol enhances memory consolidation. Both sides of the same coin open a wide range of possibilities of how stress hormones might be applied to the treatment of anxiety disorders which are thought to originate from aversive learning experiences. Indeed, some successful attempts have been made with cortisol administration to support exposure therapy, which constitutes the standard treatment in psychotherapy and relies on the principles of extinction learning. Besides, the influence of stress on extinction learning in healthy humans has been recently tested uncovering the underlying learning mechanisms. The present talk will give an overview of how stress hormones change fear extinction memories in patients with anxiety disorders as well as in healthy control participants.

Memory retrieval facilitates suppression and reconsolidation update at different temporal scales

Daniela Schiller¹, Ye Wang², Jian Li^{2,3}, Ofer Perl¹, Ilan Harpaz-Rotem^{4,5}

¹Icahn School of Medicine at Mount Sinai, Psychiatry and Neuroscience, 1 Gustave L Levy Place, 10029 New York, USA

²School of Psychological and Cognitive Sciences and Beijing Key Laboratory of Behavior and Mental Health, Peking University, Beijing, China

³DG/McGovern Institute for Brain Research, Peking University, Beijing, China

⁴Department of Psychiatry, Yale University School of Medicine, New-Haven, CT, USA

⁵The National Center for PTSD, VA CT Healthcare System, West Haven CT, USA

Memory reactivation renders consolidated memory fragile and precludes memory reconsolidation, via which the original memory can be modulated or even erased. However, research in declarative memory suggests that memory reactivation also facilitates suppression strategies distinct from memory reconsolidation and yields a more immediate amnesic effect. These findings point to the intriguing possibility that memory reactivation may prompt memory manipulations with different temporal dynamics. The talk will describe evidence that memory reactivation is required to prevent the return of fear shortly after extinction training and such effect is cue independent, consistent with suppression. Furthermore, memory reactivation triggers fear memory reconsolidation through extinction training and produces cue-specific amnesia at a longer and separable timescale. These temporal dynamics triggered by fear memory reactivation link memory suppression and reconsolidation under a unified framework for memory updating. Next, the talk will discuss the study of fear memories in a naturalistic setting. For people with post-traumatic stress disorder (PTSD), recalling traumatic memories often displays as intrusions that differ profoundly from processing of 'regular' negative memories. These mnemonic features fueled theories speculating a qualitative divergence in cognitive state linked with traumatic memories. Yet to date, little empirical evidence supports this view. The talk will describe the examination of neural activity of PTSD patients who were listening to narratives depicting their own memories. An inter-subject representational similarity analysis of cross-subject semantic content and neural patterns revealed a differentiation in hippocampal representation by narrative type: Semantically similar sad autobiographical memories elicited similar neural representations across participants. By contrast, within the same individuals, semantically thematically similar trauma memories were not represented similarly. Taken together, these findings suggest that traumatic memories are a qualitatively divergent cognitive entity.

Targeting emotional episodic memory reconsolidation in humans

Bryan Strange¹

¹Laboratory for Clinical Neuroscience, Universidad Politecnica de Madrid, Spain

Memory for traumatic experience can contribute to anxiety disorders, such as specific phobias, or trauma and stressor-related disorders such as post traumatic stress disorder (PTSD). There is emerging evidence that reactivating an old memory can temporarily return it to a labile state requiring a restabilization processes to persist, referred to as reconsolidation, and rendering the memory restabilization susceptible to manipulation. The development of protocols to selectively reduce unwanted, traumatic memories via the disruption of reconsolidation could be of potential clinical benefit. In a first study, we found that a single application of electroconvulsive therapy following memory reactivation in patients with unipolar depression disrupted reactivated, but not non-reactivated, memories for an emotional episode in a time-dependent manner. In a second study, we tested whether deep sedation could impair emotional memory reconsolidation in healthy human participants. Administering a single dose of the intravenous anesthetic propofol following memory reactivation disrupted memory for the reactivated, but not for a non-reactivated, slideshow story. Again, this effect was time-dependent, consistent with reconsolidation impairment. Critically, memory impairment occurred selectively for the emotionally negative phase of the reactivated story. These results provide a proof of concept that a routine anesthetic procedure impairs reconsolidation and could potentially be used to treat psychiatric disorders in which abnormal emotional memory plays a role.

Symposium

S5: How cellular clocks spanning multiple time scales orchestrate biological timing

[S5-1](#) Neuronal network organization of the central circadian clock

Johanna Hendrika Meijer

[S5-2](#) Orchestrating the timing of chewing and digestion - mechanisms, modulation, and stability of neuronal coupling between fast and slow stomatogastric oscillators

Wolfgang Stein, Carola Städele

[S5-3](#) Multiscale rhythms in the excitable membrane of hawkmoth olfactory receptor neurons

Katrin Schröder, Aditi Vijayan, Mauro Forlino, Anna C. Schneider, Martin E. Garcia, Monika Stengl

[S5-4](#) Entrainment and Synchronization in Coupled Circadian Oscillators

Hans-Peter Herzel

[S5-5](#) The various timescales in larval zebrafish phototactic behavior

Maxim Quirijn Capelle, Katja Slangewal, Moritz Fuchsloch, Armin Bahl

Neuronal network organization of the central circadian clock

Johanna Hendrika Meijer¹

¹Leiden University Medical Center, Neuro Physiology section, Einthovenweg 2022, 2333 ZC Leiden, Netherlands

The suprachiasmatic nuclei (SCN) function as a central circadian pacemaker. Individual neurons of the SCN are cell-autonomous oscillators. In contrast, many other attributes of the clock arise at the network level. In this presentation the emergent properties of the network are explained, and major difference between nocturnal and diurnal species will be shown on the basis of recent research.

Orchestrating the timing of chewing and digestion - mechanisms, modulation, and stability of neuronal coupling between fast and slow stomatogastric oscillators

Wolfgang Stein¹, Carola Städele²

¹Illinois State University, School of Biological Sciences, Campus Box 4120, 61790 Normal, USA

²University Medical Center Göttingen, Institute for Neuro- and Sensory Physiology, Humboldtallee 23, 37073 Göttingen, Germany

Coordinating neuronal oscillators that run at different speeds is a common, yet crucial task of the nervous system. Examples in motor control are manifold and include the coordination of involuntary movement such as breathing and locomotion, and chewing and swallowing, but also the concerted movements of hands and fingers when drumming to the beat of music. Such coordination not only requires the generation of the individual periodic activities, but also consolidating them into behaviorally meaningful orchestrations that emerge from the collective dynamics of processes that act on dramatically different time scales. Synchrony and integer-coupling between neuronal oscillators are prominent examples of such collective behaviors.

While the neuronal connections that create the coupling between oscillators have been studied in many systems, the dynamics and boundary conditions within which such couplings can be maintained are often unknown. Acute temperature changes, for example, can disrupt neuronal activity and coordination with severe consequences for animal behavior and survival. We study temperature robustness of two integer-coupled neuronal circuits in the crustacean stomatogastric ganglion (STG), the pyloric and gastric mill central pattern generators. The cycle periods of the gastric mill rhythm and the pyloric rhythm differ by about 10-fold, with each gastric mill period being an integer multiple of the pyloric period. Both rhythms show a broad temperature robustness, as they remain active across a range of more than 30°C. The temperature robustness of the two rhythms appears to be partly based on different mechanisms, with the pyloric rhythm relying mostly on circuit-intrinsic properties and the gastric mill rhythm requiring extrinsic neuromodulation to remain active at elevated temperature. We dissociated temperature effects on the rhythm-generating circuits from extrinsic modulatory influences from upstream ganglia. We demonstrate that heat-activated factors extrinsic to the rhythm generators are essential to the slow gastric mill rhythm's temperature robustness and contribute to the temperature response of the fast pyloric rhythm. The gastric mill rhythm crashed when its rhythm generator in the STG was heated. It was restored when upstream ganglia were heated and temperature-matched to the STG. Temperature-matching increased the activity of the peptidergic modulatory projection neuron (MCN1), which excites the gastric mill circuit. Correspondingly, MCN1's neuropeptide transmitter stabilized the rhythm and maintained it over a broad temperature range. Extrinsic neuromodulation is thus essential for the oscillatory circuits in the STG and enables neural circuits to maintain function in temperature-compromised conditions.

In contrast, integer coupling between pyloric and gastric mill rhythms was independent of whether extrinsic inputs and STG pattern generators were temperature-matched or not, demonstrating that the temperature robustness of the coupling is enabled by properties intrinsic to the rhythm generators. However, at near-crash temperature, integer coupling failed in some animals while it was maintained in others. This was true even though regular rhythmic activity continued in all tested animals, indicating that the coupling between the two oscillators was near its breaking point. We are currently testing the conditions under which coupling

fails.

Multiscale rhythms in the excitable membrane of hawkmoth olfactory receptor neurons

Katrin Schröder¹, Aditi Vijayan¹, Mauro Forlino², Anna C. Schneider¹, Martin E. Garcia²,
Monika Stengl¹

¹University of Kassel, Animal Physiology / Neuroethology, Heinrich-Plett-Str. 40, 34132 Kassel, Germany

²University of Kassel, Theoretical Physics, Heinrich-Plett-Str. 40, 34132 Kassel, Germany

Environmental rhythms generated by the movements of earth and moon dominate the timing of life on earth. During evolution organisms developed endogenous clocks to tune into and predict environmental rhythms. Best studied is the circadian clock of the fruit fly *Drosophila melanogaster* that embeds the insect into the daily rhythms of light and dark. Transcriptional and posttranscriptional feedback loops generate rhythms of about 24 h of mRNA and protein-level oscillations of circadian clock molecules, such as PERIOD, even under constant conditions. Thus, these oscillations constitute an endogenous molecular clockwork in the nucleus and cytoplasm of single circadian clock neurons in the brain of the insect, generating endogenous circadian rhythms. Next to these central circadian clock neurons exist peripheral circadian clock neurons, such as photoreceptor cells in the compound eye, or chemosensory cells in the antenna, that detect 24 h rhythms in the environment. Besides circadian rhythms animals express some behavior on shorter (ultradian) or longer (infradian) timescales, for example multiple feeding periods during the day or annual migration. Little is known whether and how peripheral clocks also express ultradian and/or infradian rhythms. The present work is devoted to the study of chemosensory cells in the insect antenna in search for multiscale rhythms in its excitable membrane.

Applying electrophysiological methods, we examined the olfactory receptor neurons (ORNs) that innervate the pheromone-sensitive long trichoid sensilla in the antenna of the hawkmoth *Manduca sexta*, an established model insect in chemosensory and physiological research. In the absence of pheromone stimulation, the ORNs generated spontaneous action potentials via unknown mechanisms. Our goal is to determine whether the excitable membrane of ORNs generates multiscale (circa-, ultra-, infradian) rhythms in the absence of stimulation, which would provide evidence that ORNs are adaptive multiscale oscillators that may be able to resonate with environmental rhythms of various frequencies. Indeed, we found endogenous action potential rhythms in the range of circadian and ultradian frequencies that appeared to be linked. Currently, we use patch clamp recordings combined with pharmacology, and theoretical models to examine and predict which ion channels are responsible for membrane potential oscillations at different frequencies. Furthermore, we test whether neuropeptides that are identified circadian coupling factors modulate the frequency tuning of ORNs.

Supported by DFG research training group 2749/1 "Multiscale Clocks".

Entrainment and Synchronization in Coupled Circadian Oscillators

Hans-Peter Herzel¹

¹Institute for Theoretical Biology, Chronobiology, Chariteplatz 1, 10117 Berlin, Germany

The circadian clocks in insects and mammals are based on networks of coupled oscillators. Synchronization allows the coordination of activities, hormonal signals, metabolism, and immunity. External zeitgebers entrain these autonomous clocks. Mathematical models of these processes include delayed negative feedbacks, mutual coupling of cellular oscillators, and fine-tuning of phases. We discuss design principles of intrinsic oscillator networks and entrainment. Oscillator theory provides insight how robust synchronization and control of the entrainment phase is achieved.

The various timescales in larval zebrafish phototactic behavior

Maxim Quirijn Capelle, Katja Slangewal^{1,2,3,5}, Moritz Fuchsloch³, Armin Bahl^{1,2,3,4}

¹International Max Planck Research School for Quantitative Behavior, Ecology and Evolution from lab to field

²Centre for the Advanced Study of Collective Behaviour

³University of Konstanz

⁴Zukunftskolleg Konstanz

⁵Boehringer-Ingelheim Fonds

To navigate in dynamic natural environments, animals need to constantly integrate and evaluate sensory cues during decision-making. Such behavior needs to be modulated by the internal perceptual state of the animal on timescales across multiple orders of magnitude. However, the mechanistic implementation of these underlying processes in the brain remains poorly understood. Recently, it has been shown that larval zebrafish behavior is more flexible than previously thought, making it a suitable system to address these questions. Here, we employ closed-loop high-throughput behavioral assays to explore this problem in the context of larval zebrafish phototaxis. We demonstrate that phototaxis is regulated by fixed innate preferences and sensory experience on timescales of tens of seconds. We develop a simple computational model combined with multi-objective fitting strategies to capture the dynamics of our behavioral datasets. From this optimized model, we infer the underlying cognitive algorithms, allowing us to make specific predictions about the respective decision-making mechanisms in the nervous system. By using whole-brain two-photon functional imaging, we identify cells and brain regions that may implement our proposed model. Based on our findings, we aim to develop biologically plausible network models for adaptive behaviors and to systemically dissect the underlying neural circuitry.

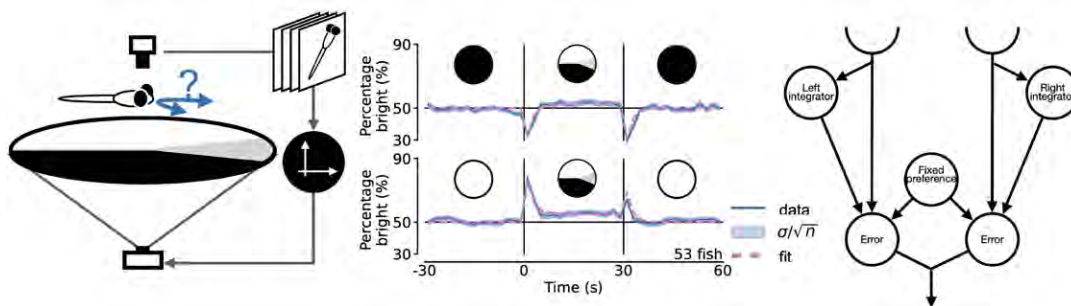

Symposium

S6: Cerebellum and mushroom body: common circuit motifs for learning and adaptive behaviour?

[S6-1](#) Cerebellum and reinforcement learning in humans and rodents
Dagmar Timmann

[S6-2](#) Recent advances in understanding the neural circuits of associative learning in *Drosophila melanogaster*
Johannes Felsenberg

[S6-3](#) The functional organization of mushroom body output pathways in larval *Drosophila*
Claire Eschbach

[S6-4](#) The functional organization of cerebellum output pathways in rodents
Daniela Popa

[S6-5](#) Action, valence, dopamine- *Drosophila* as a study case
Fatima Amin, Christian König, Bertram Gerber, Salil Bidaye, David Oswald, Oliver Barnstedt, Benjamin Barger, Nino Mancini, Anna Pierzchlinska, Thomas Niewalda

Cerebellum and reinforcement learning in humans and rodents

Dagmar Timmann¹

¹Essen University Hospital and Center for Translational and Behavioral Neuroscience, Department of Neurology, Hufelandstrasse 55, 45147 Essen, Germany

The contribution of the cerebellum to associative learning is well known. Classical eyeblink conditioning has been studied in greatest detail, and there is good evidence that the cerebellum contributes to the acquisition and retention of conditioned eyeblink responses in both humans and rodents. Although involvement of the cerebellum in fear conditioning has already been shown more than 30 years ago, only recently, the study of cerebellar involvement in this form of emotional associative learning has regained interest in the field. The starting point of my presentation will be data of a 7T functional magnetic resonance imaging (fMRI) study of differential fear conditioning performed in young and healthy human participants (Ernst et al. eLife 2019). We found increased cerebellar fMRI signal related to the prediction of the aversive unconditioned stimulus (US; an electric shock), confirming that the cerebellum is involved in learning the association of the conditioned stimulus (CS; a visual stimulus) and the US. Cerebellar activation, however, was most prominent at the time the US was expected and did not occur (that is, in unreinforced CS+ trials in the acquisition learning phase). The unexpected omission of an aversive stimulus has been interpreted as a rewarding stimulus (e.g. Kalisch et al. Trends Cogn Sci. 2019). One may argue that the increased fMRI signal of the cerebellum during the unexpected omission of the US is related to the unexpected presentation of a reward (that is, a reward prediction error). Furthermore, the unreinforced CS+ trials, which were interspersed in the acquisition phase, can be interpreted as initial extinction trials, and the observed fMRI signal in the cerebellum may be related to the processing of (reward) prediction error signals that drive extinction learning. This interpretation fits well with recent findings in the rodent literature which show that the cerebellum may not only process sensorimotor signals and be crucial for sensory error-based learning, but also processes reward signals and therefore contributes to reinforcement learning, a form of learning which is typically associated with the mesostriatal and mesocorticolimbic dopaminergic system (Doya Neural Netw 1999). Data of recording studies in rodents will be presented which provide increasing evidence that the cerebellum does not only receive sensory input, but also afferent input about rewards, reward predictions and reward prediction errors via the mossy fiber and climbing fiber system (e.g. Wagner et al. Nature 2017; Sendhilnathan et al. Nat Commun 2021; Hull eLife 2020 for review; Kostadinov and Häusser Neuron 2022 for review). This data will provide the basis for a discussion of possible parallels between climbing fibers and dopaminergic input neurons (DANs) of the mushroom body in insects on one hand, and between mossy fibers/granule cells and sensory projection-neuron inputs (PNs)/Kenyon cells (that is, mushroom body neurons) in appetitive and aversive conditioning on the other.

Recent advances in understanding the neural circuits of associative learning in *Drosophila melanogaster*

Johannes Felsenberg¹

¹FMI Basel, Maulbeerstrasse 66, 4058 Basel, Switzerland

Associative learning allows cues to steer behaviour towards the efficient seeking of desirable outcomes or the avoidance of potential danger. During olfactory conditioning fruit flies can learn that specific odours predict either food reward or electric shock punishment. The expression of the memory seems to rely on learning-induced dopamine-driven plasticity in mushroom body output pathways. In adult flies, heterogeneity in the dopamine system allows to establish parallel memories of different valence, strength and for different reward categories. In addition, the highly recurrent structure of the mushroom body circuits supports the re-evaluation of learned behaviour when prediction turn out to be inaccurate. I will summarize our recent findings, highlighting how olfactory memories in *Drosophila melanogaster* can be reevaluated.

The functional organization of mushroom body output pathways in larval *Drosophila*

Claire Eschbach¹

¹Paris-Saclay Institute of Neuroscience CNRS, Cognitive & Network Neuroscience, Campus CEA Saclay, 151 route de la Rotonde, 91400 Saclay, France

For adaptive decisions to be made in an ever-changing environment, animals must be able to update expectations about stimuli valences and integrate these predictions with the innate circuits that drive the behaviour by default. We tackled this question in *Drosophila* larva, an animal with a small brain, allowing large-scale electron microscopy circuit mapping, and capable of learning and memory. Associative memories in *Drosophila* are formed at the output synapses of the parallel Kenyon Cells of the Mushroom Body that signal conditioned stimuli, especially odours. Of note, the set of ca. 2x200 larval Kenyon cells presents features like the parallel fibres of cerebellum: sparse coding of sensory signals allowing precise coding of predictive cues, and fan-in fan-out design allowing multiple memories to reach a limited number of efferent neurons. As a result, the odour-driven memory signal is relayed by the 2x24 Mushroom Body output neurons (MBONs) to skew behaviour towards e.g. attraction vs. aversion.

We first characterized, using optogenetic, which individual MBON biases the behaviour towards attraction or aversion. We then used EM reconstruction to investigate the type of interactions between the different MBONs and the efferent neurons thought to drive innate behaviour. We identified different sites of converging inputs between the MB output pathway and pathways for innate sensory response. We characterized the encoding of innate and learned cues by one of these 'convergence neurons', showing that it is excited by innately attractive odour, inhibited by learned aversive odour or an innately repulsive cue. We attempt to relate these findings with the fully reconstructed neuronal circuit and to draw some conclusions on the way in which innate attraction can be switched to learnt avoidance within the brain of *Drosophila* larva.

The functional organization of cerebellum output pathways in rodents

Daniela Popa¹

¹Institut de Biologie de l'Ecole Normale Supérieure, Neurophysiology of Brain Circuits group, Neurosciences, 46 rue d'Ulm, 75005 Paris, France

Our goal is to understand the function of the reciprocal communication between the cerebellum and the forebrain. For this purpose, we use a multi-scale approach combining the analysis of the cellular physiology and of the network activity in the circuits linking the cerebellum and the forebrain in normal and pathological conditions. We combine a variety of techniques including opto- and pharmaco-genetics, in vivo electrophysiology in behaving animals, anatomical tracing.

Action, valence, dopamine- *Drosophila* as a study case

Fatima Amin, Christian König¹, Bertram Gerber¹, Salil Bidaye², David Oswald³, Oliver Barnstedt¹, Benjamin Barger², Nino Mancini², Anna Pierzchlińska⁴, Thomas Niewalda¹

¹Department Genetics of Learning and Memory, Leibniz Institute for Neurobiology, Magdeburg, Germany

²Max Planck Florida Institute for Neuroscience, Florida, USA

³ Institute of Neurophysiology, Charité – Universitätsmedizin Berlin, Germany

⁴ Institute of Zoology, Biocenter Cologne, University of Cologne, Germany

Conventional wisdom has it that we learn to avoid what we dislike. Consequently, sensing or expecting a situation that we do not like makes us slow down and switch to a situationally adaptive behavior. In the case of *Drosophila* such “switching of gears” can consist of taking off and flying away, or if this does not seem warranted or is not feasible, of briefly walking backwards, stepping sideways, and resuming a novel walking direction (Feng et al. 2020). In other words, flies just like humans avoid what they dislike. We wondered whether the reverse can also be true, that avoiding a situation can make the flies dislike it. To study such action-to-valence causation we induce backward locomotion by activating a set of descending brain neurons called ‘moonwalker neurons’ (Bidaye et al. 2014), and test whether odors presented during such backward locomotion acquire negative valence. In a combination of behavioral analyses, optogenetics, pharmacology, connectomics, immunohistochemistry, and neurophysiology we are investigating the role of movement and of the dopaminergic reinforcement system in this paradigm. Furthermore, we ask whether the ‘moonwalker neurons’ are part of the efferent mnemonic pathways from the mushroom body towards the motor periphery, and what the implications of a possible action-to-valence causation are for maintaining successful learned avoidance.

References:

Feng, K. et al. Distributed control of motor circuits for backward walking in *Drosophila*. *Nat Commun* (2020)
Bidaye, S.S. et al. Neuronal control of *Drosophila* walking direction. *Science* (2014)

Symposium

S7: Disease-specific autoantibodies against neuronal surface antigens disrupt synaptic function

[S7-1](#) Anti-NMDA receptor encephalitis: from discovery to new insights
Josep Dalmau

[S7-2](#) Anti-NMDAR autoantibodies disrupt CA1 place cell dynamics
Sabine Liebscher

[S7-3](#) Human Cerebrospinal Fluid Monoclonal LGI1 Autoantibodies Increase Neuronal Excitability
Dietmar Schmitz

[S7-4](#) Neuropathology of antibody-associated encephalitis
Romana Höftberger

[S7-5](#) Human anti-GluNR1 autoantibodies influence NMDAR channel function
Taha Abdulla, Holger Haselmann, Harald Prüß, Manfred Heckmann, Christian Geis

Anti-NMDA receptor encephalitis: from discovery to new insights

Josep Dalmau¹

¹IDIBAPS-University of Barcelona, Neuroimmunology, Casanova 143, P3A, 08036 Barcelona, Spain

In 2005 the discovery that a group of patients with different encephalitic syndromes harbored antibodies against neuronal surface proteins was the foundation for studies that led to the identification of a new category of diseases, the autoimmune encephalitis. The first to be fully characterized was anti-NMDA receptor (NMDAR) encephalitis. This disorder associates with antibodies against the extracellular amino-terminal domain of the GluN1 subunit of the receptor that cause a predictable syndrome. Most patients with this disease are children or young adults that initially present with psychotic and behavioral alterations accompanied or followed by the development of severe neurologic deficits. Even when properly diagnosed and treated, there is a prolonged process of recovery that may last several months or a few years. All patients have antibodies in CSF (less frequently serum) that crosslink and internalize NMDARs, disrupt their trafficking and interaction with other synaptic partners (dopamine 1 receptor, ephrin B2 receptor), and alter synaptic transmission, plasticity and circuitry function. In mouse models of passive cerebroventricular transfer of antibodies, as well as in models of active immunization, the antibody alterations associate with changes in memory, behavior (psychotic- and depressive-like features), seizures and movement disorders, supporting the pathogenicity of the antibodies. In recent years we have identified potential triggers of the disease (tumors, viral infections), and characterized two distinct disease stages (acute, post-acute) that may be misdiagnosed as other disorders associated with hypofunction of NMDAR (i.e., schizophrenia). Current studies are aimed to better understand the disease through clinical trials and animal models. Preliminary data suggest that in addition to immunotherapy, allosteric modulators of NMDAR and AMPAR may hasten symptom improvement and result in better clinical outcomes.

Anti-NMDAR autoantibodies disrupt CA1 place cell dynamics

Sabine Liebscher¹

¹Klinikum der Universität München, Institute of Clinical Neuroimmunology, Grosshaderner Strasse 9, 82152 Martinsried, Germany

Disease-specific autoantibodies against neuronal surface antigens disrupt synaptic function

The discovery of autoantibodies against synaptic antigens in the central nervous system (CNS) in patients with severe neuropsychiatric disorders was a breakthrough in neurology.

This novel entity of CNS disorders has been termed “autoimmune encephalitis”. As of today, more than 15 target molecules have been identified to which specific autoantibodies are directed each defining a subtype of disease. Importantly, these target antigens are all part of central synapses and are comprised of ionotropic and metabotropic receptors (e.g. NMDA, Glycine and GABAB receptors) as well as adhesion and transsynaptic signaling molecules (e.g. LGI1) intracellular neuronal or glial antigens.

This symposium will address how disease-specific human antibodies impact neuronal and synaptic function leading to severe brain disease and prototypical disease symptoms. Josep Dalmau (University of Barcelona, Spain) will report the discovery of NMDA receptor antibodies in patients with autoimmune brain disorders. Anti-NMDA receptor (NMDAR) autoimmune encephalitis is a severe immunological condition, caused by autoantibodies targeting subunits of the NMDA receptor. Antibodies induce internalization of NMDA receptors and cause defective synaptic function and plasticity. Recent approaches using positive allosteric modulators of NMDA receptors can rescue antibody-induced synaptic dysfunction and improve disease symptoms in a mouse model of NMDA receptor encephalitis.

The neural and circuit mechanisms giving rise to the complex symptoms typical of NMDAR autoimmune encephalitis, remain poorly understood. Sabine Liebscher (University of Munich) will present novel findings regarding the impact of NMDAR antibodies on structural plasticity and response properties of neuronal subtypes in the CA1 region of the hippocampus, assessed by means of longitudinal in vivo two-photon imaging in a passive transfer mouse model of the disease. Her data indicate that compromised dynamics of spatial representations could represent a neural correlate of memory and cognitive deficits typical of the disease.

Dietmar Schmitz (Charité University Medicine Berlin) will report cloning of human monoclonal antibodies to the synaptic linker protein LGI1. Antibodies to LGI1 interfere with presynaptic signaling and disrupt binding to its receptor ADAM22 leading to increased intrinsic cellular excitability and glutamatergic synaptic transmission of hippocampal CA3 neurons in slice cultures. These changes possibly explain hyperexcitability and seizure initiation patients with LGI1 encephalitis.

The neuropathology of autoimmune encephalitis with neuronal surface antibodies show a spectrum of inflammation with prominent B cell component and well-preserved neurons up to features of defective synaptic signalling resulting in neuronal dysfunction and subsequent cell death after long-term exposure to the antibodies. Romana Höftberger (University of Vienna, Austria) will present the neuropathological features in brain autopsy tissue of patients with autoimmune encephalitis associated with antibodies against surface receptors versus intracellular antigens and discuss mechanisms that are involved in the

pathogenesis.

In summary, the symposium will bring together interdisciplinary experts to highlight our current knowledge on antibody-induced CNS disease and synaptic pathology determining neuropsychiatric disease.

Human Cerebrospinal Fluid Monoclonal LGI1 Autoantibodies Increase Neuronal Excitability

Dietmar Schmitz¹

¹Charité, Neuroscience Research Center, Charitéplatz 1, 10117 Berlin, Germany

Leucine-rich glioma-inactivated 1 (LGI1) encephalitis is the second most common antibody-mediated encephalopathy, but insight into the intrathecal B-cell autoimmune response, including clonal relationships, isotype distribution, frequency, and pathogenic effects of single LGI1 antibodies, has remained limited. We cloned, expressed, and tested antibodies from antibody-secreting cells (ASCs) and B cells from the cerebrospinal fluid (CSF) of several patients with LGI1 encephalitis.

All LGI1 antibodies were of IgG1, IgG2, or IgG4 isotype and had undergone affinity maturation. Seven of the overall 26 LGI1 antibodies efficiently blocked the interaction of LGI1 with its receptor ADAM22 in vitro, and their mean LGI1 signal on mouse brain sections was weak compared to the remaining, non-ADAM22-competing antibodies. We tested the functional impact of LGI1 antibodies in hippocampal brain slices using electrophysiological methods. Both types of LGI1 antibodies increased the intrinsic cellular excitability and glutamatergic synaptic transmission of hippocampal CA3 neurons. Our data show that the patients' intrathecal B-cell autoimmune response is dominated by LGI1 antibodies and that LGI1 antibodies alone are sufficient to promote neuronal excitability, a basis of seizure generation.

Neuropathology of antibody-associated encephalitis

Romana Höftberger¹

¹Medical University of Vienna, Division of Neuropathology and Neurochemistry, Waehringer Guertel 18-20, 1090 Vienna, Austria

Antibody-associated autoimmune encephalitis is a group of immune-mediated diseases that harbor antibodies directed against intracellular neuronal antigens, synaptic surface proteins, or glial antigens. While autoimmune encephalitis with intracellular neuronal antibodies is mostly associated with irreversible neuronal cell loss and T cell-dominated inflammation, the neuropathology of neuronal surface antibodies may show a spectrum of inflammation with prominent B cell component and well-preserved neurons to features of defective synaptic signalling resulting in neuronal dysfunction and subsequent cell death after long-term exposure to the antibodies. This presentation will focus on the neuropathological features in brain autopsy tissue of patients with autoimmune encephalitis associated with antibodies against surface receptors versus intracellular antigens and discuss mechanisms that are involved in the pathogenesis.

Human anti-GluNR1 autoantibodies influence NMDAR channel function

Taha Abdulla, Holger Haselmann¹, Harald Prüß², Manfred Heckmann³, Christian Geis¹

¹Universitätsklinikum Jena, Translational Neuroimmunology, Am Klinikum 1, 07747 Jena, Germany

²Department of Neurology and Experimental Neurology, Charité, Universitätsmedizin Berlin, Germany

³Julius-Maximilians Universität Würzburg, Department of Neurophysiology/ Institute of Physiology, Würzburg, Germany

Scientific background of the talk: Autoantibodies (aAb) play the main role in the pathogenesis of autoimmune encephalitis (AIE) by binding to the specific sites on the neuronal surface antigens. Interestingly, aAb-antigen interactions lead to diverse mechanisms of actions, including receptor internalization (aAb-NMDARs), direct blocking of ligand binding sites (aAb-GABA_BR), disrupting trans-synaptic protein-protein interaction (aAb-LGI1) and activating complement system (aAb-CASPR2). Hence, understanding the aAb-antigen interactions in detail and the factors that influence these interactions is vital for a basic understanding of the pathophysiology and advancing treatment of AIE.

In this talk, we focus on aAb against NMDAR. It is well established that NMDAR-aAbs reduce surface receptor density by crosslinking with neighboring bound aAbs and then internalizing the receptor. While pursuing to understand the possible acute effects of aAbs prior to receptor internalization, we observed that the aAb binding kinetics, importantly the time it takes for aAbs to bind (on-rate) and the time aAbs take to internalize the receptors affect the channel function of NMDARs and thereby influencing NMDAR-mediated post-synaptic responses.

Methods: To measure the direct effects of human pathogenic antibodies on NMDAR responses, whole-cell patch recordings were applied in both NR1/NR2A transfected NG108-15 cells and cultured neurons. In cultured neuron recordings, NMDAR currents were pharmacologically isolated using various blockers. For the fast application of different NMDAR modulators (including ligands and pathogenic antibodies), a fast solution exchange system was applied, which can switch between multiple solutions with a controllable flow rate. Moreover, immunostaining was followed by imaging using confocal microscopy to evaluate the antibodies' binding kinetics to NMDARs during fast perfusion.

Results: We observed that a five-minute application of IgG003-102 (a mAb against NMDARs) to both NMDAR-transfected NG108-15 cells and cultured neurons reduces the peak amplitude of ligand-evoked NMDAR currents. However, shorter incubation durations, like 30 seconds or one minute, do not significantly decrease the peak amplitude of NMDAR currents. Regarding the effect on post-synaptic responses, IgG003-102, after 30-minute of incubation, reduced the spontaneous excitatory post-synaptic currents (sEPSCs) prior to the receptor internalization. This indicates the importance of the on-rate of IgG003-102 for proper binding and affecting the channel function.

Conclusion: Human pathogenic antibodies to the NMDAR GluN1 subunit influence NMDAR channel function. Binding kinetics play a vital role in the pathogenicity of these aAbs. These direct effects may contribute to NMDAR-directed pathology and the development of disease symptoms in patients

Symposium

S8: Molecular Mechanisms of Synaptic Brain Disorders

- [S8-1](#) Personalized medicine of brain wiring? In utero crispr technologies for rapid modeling of individual patients
Alexandros Pouloupoulos, Colin Robertson, Cheryl Brandenburg, Andrea Romanowski, Bekir Altas, Ryan Richardson, Garrett Bunce
- [S8-2](#) Amyotrophic lateral sclerosis: loss of TDP-43 from the nucleus and consequences at the synapse
Pietro Fratta
- [S8-3](#) GABAergic synapse diversity as a means to developing novel therapeutic strategies for psychiatric disorders.
Dilja Krueger-Burg
- [S8-4](#) Disease mechanisms and intervention strategies for SNAREopathies, syndromes caused by mutations in presynaptic genes
Matthijs Verhage
- [S8-5](#) Organization and dynamics of Cav2.1 channels shape the short-term plasticity in hippocampal synapses
Abderazzaq El Khallouqi, Anna Carolina Palmeira do Amaral, Artur Bikbaev, Jennifer Heck, Melanie Mark, Stephane Herlitze, Martin Heine

Personalized medicine of brain wiring? In utero crispr technologies for rapid modeling of individual patients

Alexandros Pouloupoulos¹, Colin Robertson¹, Cheryl Brandenburg¹, Andrea Romanowski¹,
Bekir Altas¹, Ryan Richardson¹, Garrett Bunce¹

¹University of Maryland School of Medicine, Department of Pharmacology, Baltimore, MD, USA

New CRISPR technologies are changing the way we do research and hold exciting promise for revolutionizing medicine. Targeting the brain for genome editing involves added challenges and requires new, more precise, CRISPR agents. Here we present work with some of these new CRISPR agents, including Prime Editors and Cas9-RC, and their application to Neural Somatic Genome Editing in the brain, with a view to their use in revealing miswiring in epilepsy and schizophrenia, and future use for rapid patient models in personalized medicine applications.

Amyotrophic lateral sclerosis: loss of TDP-43 from the nucleus and consequences at the synapse

Pietro Fratta¹

¹University College London, Neuromuscular Disease, Queen square, WC1N 3BG London, United Kingdom

Nuclear depletion of the RNA binding protein TDP-43 is a hallmark pathological finding in amyotrophic lateral sclerosis (ALS) and frontotemporal dementia (FTD). This event induces a wide range of RNA processing alterations, including a derepression of intronic sequences resulting in their inclusion in mature RNA transcripts - these are named cryptic exons. Frequently the consequence of cryptic exons is to induce RNA degradation and consequently protein loss.

A number of cryptic exons are located in synaptic genes, and recent work has highlighted how this phenomenon is relevant to disease progression. This talk will discuss these recent advances and strategies to therapeutically target these events.

GABAergic synapse diversity as a means to developing novel therapeutic strategies for psychiatric disorders.

Dilja Krueger-Burg¹

¹Mainz University Medical Center, Institute of Anatomy, Duesbergweg 6, 55128 Mainz, Germany

Abnormalities in the balance of excitatory to inhibitory neurotransmission have been proposed to play a key role in the etiology of psychiatric and neurodevelopmental disorders, and substantial evidence links mutations in the proteins that mediate excitatory synaptic transmission to these disorders. In contrast, the role of alterations in the molecular machinery at inhibitory synapses has received surprisingly little attention. In recent years, however, an increasing number of variants in GABAergic postsynaptic proteins has been identified in patients with autism spectrum disorder, schizophrenia and/or intellectual disability, highlighting the urgent need for a better understanding of the involvement of these proteins in health and disease. Here I present recent studies on the molecular mechanisms by which the prototypical GABAergic synaptic adhesion protein Neuroligin-2 and its interaction partners regulate behavioral circuits underlying affective behaviors in mouse models. In particular, I focus on a key theme that emerges from these studies, i.e. the importance of GABAergic synapse diversity in understanding the consequences of mutations in these proteins on behavioral output. The GABAergic inhibitory system is highly heterogeneous, with a large number of neuronal subtypes contributing vastly different functions to neuronal information processing, and recent evidence indicates that this cellular diversity is accompanied by a corresponding molecular diversity at GABAergic synapses. By identifying synapse- and circuit-specific functions of individual GABAergic postsynaptic proteins, it may not only be possible to better understand their role in the pathogenesis of psychiatric and neurodevelopmental disorders, but also to develop circuit-specific therapeutic approaches with improved selectivity for the targeted behavioral symptoms.

Disease mechanisms and intervention strategies for SNAREopathies, syndromes caused by mutations in presynaptic genes

Matthijs Verhage¹

¹Center for Neurogenomics and Cognitive Research, Vrije Universiteit Amsterdam and Amsterdam University Medical Center, DeBoelelaan 1085, 1085HV Amsterdam, Netherlands

SNAREopathies are syndromes caused by mutations in presynaptic SNARE proteins and their key regulators that together drive synaptic vesicle exocytosis and synaptic transmission as a single, integrated membrane fusion-machine. SNAREopathies are characterized by developmental delay, intellectual disability, epilepsy, and are among the most common diagnoses in patients referred for genetic testing for epilepsy. We have studied SNAREopathies, especially caused by mutations in STXBP1 and SYT1 genes, in patient cohorts, in mouse models and in cultured neurons from these patients, obtained via biopsies and iPSC technology.

Using mouse models and iPSC-derived patient neurons we have established haploinsufficiency as a plausible disease mechanism. However, while mutations in SYT1 lead to functional deficits, we show that all pathogenic STXBP1 mutations lead to protein instability, reduced cellular levels, substantial reorganization of the synaptic proteome, changes in neuronal network activity, hyper-excitability, EEG abnormalities and cognitive deficits. We have used the observed cellular phenotypes to design new intervention strategies for several SNAREopathies. In addition, we have used new EEG analyses, combining information in both temporal and frequency domain, in SNAREopathy patients to obtain EEG biomarkers for excitation/inhibition imbalance. We are using modelling approaches to integrate activity parameters in iPSC-derived neuronal networks from each patient and connect these to EEG biomarker data in the same patient. This data integration is used to predict treatment responses and establish personalized cell/ EEG-based treatment decisions.

Organization and dynamics of Cav2.1 channels shape the short-term plasticity in hippocampal synapses

Abderazzaq El Khallouqi, Anna Carolina Palmeira do Amaral¹, Artur Bikbaev¹, Jennifer Heck², Melanie Mark³, Stephane Herlitze³, Martin Heine¹

¹Institution for Developmental Biology and Neurobiology, Functional Neurobiology, Hanns-Dieter Hüsch Weg 15, 55128 Mainz, Germany

²Genome Biology Unit, European molecular biology laboratory (EMBL), Heidelberg, Germany

³General Zoology and Neurobiology, Ruhr-University Bochum, Germany

The kinetic properties of presynaptic calcium channels, including the activation state and conductivity but also their spatial arrangement, are critical parameters shaping the release probability of synapses. Cav2.1 (P/Q-type channels) represent the main population of voltage-gated calcium channels in the majority of central synapses of the mammalian brain. Within the presynaptic membrane, the Cav2.1 were found to be clustered in the active zone (AZ). However, it remains unclear whether the nanoscale-organization of such clusters are synapse type-specific and whether they have an impact on the short-term plasticity.

To address these questions, we used a Cacna1a-Citrine knock-in mouse model together with an anti-GFP nanobody in combination with super-resolution microscopy (STED and dSTORM) to directly target and characterize the nanocluster organization of the endogenous population of Cav2.1 in AZ. We found that the cluster size of calcium channels is smaller in inhibitory synapses as compared to excitatory synapses. Furthermore, we generated an anti-GFP intrabody expression vector to monitor the local dynamics of Cav2.1. Our mobility data show an ongoing rearrangement and replacement of Cav2.1 channels within the synapse. Interestingly, the manipulation with presynaptic G protein-coupled receptors (GPCRs) also influenced the Cav2.1 dynamics and nanocluster organization. Artificial clustering of Cav2.1 by photoactivatable cross-linkers induced a shrinkage of nanoclusters, which affected the impact of GPCR modulation on the synaptic function that was evaluated by the glutamate imaging, calcium imaging and electrophysiology. Taken together, this data suggests that the short-term plasticity is influenced by the rearrangement of Cav2.1 nanoclusters inside the AZ, which can serve as an initial step leading to sustained changes in synaptic transmission.

Symposium

S9: New advances in the neuroscience underlying socio-emotional behaviour

[S9-1](#) Molecular mechanisms of social behaviors

Hanna Hörnberg

[S9-2](#) Neural correlates of social learning about rewards

Ewelina Knapska

[S9-3](#) Septal mechanisms regulating social fear extinction: A role for neuropeptide signaling

Rohit Menon

[S9-4](#) Regulation of social behaviors by the lateral septum

Francisco Javier de los Santos Bernal, Robson Scheffer Teixeira, Letizia Moscato, Hanna van den Munkhof, Haena Choi, Tatiana Korotkova

[S9-5](#) The link between body-brain interaction and social behavior

Soyoung Q Park

Molecular mechanisms of social behaviors

Hanna Hörnberg¹

¹Max Delbrück Center for Molecular Medicine in the Helmholtz Association (MDC), Molecular and cellular basis of behavior, Robert-Rössle-Straße 10, 13125 Berlin, Germany

Alterations in social interaction and communication are common symptoms of many neurodevelopmental conditions. These conditions are diverse, with a large heterogeneity of clinical features and high rates of symptom overlap between different diagnoses. Genes associated with neurodevelopmental conditions can be grouped functionally into convergent pathways, with the most prominent ones including synaptic function and translational regulation. However, the relationship between convergent genetic pathways and symptomatic variability is poorly understood. I will discuss our work using mouse models to examine the link between genotype, signaling pathway, and phenotype. We use automated behavioral readouts in freely-interacting animals to measure differences in social behaviors in multiple mouse models, with the goal of identifying molecular mechanisms that can explain individual variability. We have identified an unexpected convergence between two of the core pathways linked to neurodevelopmental conditions: synaptic proteins and translational regulation, and show that modulating translation can restore social behaviors. Focusing on such convergent mechanisms at the intersection of multiple signaling pathways could represent a promising method to identify treatments that cut across clinical diagnoses and etiological factors.

Neural correlates of social learning about rewards

Ewelina Knapska¹

¹Nencki Institute of Experimental Biology, PAS, BRAINCITY, Pasteur 3, 02-093 Warsaw, Poland

In social species, emotions displayed by others influence the cognition and behavior of the interacting individuals. It is believed that the capacity to be affected by the affective states of others helps to adapt to the physical and social environment; however, the neural and behavioral mechanisms of responding to others' emotions are still insufficiently understood.

We studied how mice get information about food location from recently fed conspecifics. Food intake activates the reward system in the brain, resulting in a positive affective state. We found that a hungry mouse stays close to a recently fed conspecific. When the demonstrator mouse was fed in a place distinguished by an olfactory cue, the interaction resulted in a transfer of information about food location. Socially transferring information about a distant food source activates the hippocampus and involves remapping hippocampal place cells. It also activates the olfactory tubercle, a part of the reward system. Using an automated system for tracing the behavior of group-housed mice in a semi-natural environment, we show that socially acquired knowledge changes the exploration patterns of familiar and novel environments. The mice can transfer information about food by direct social interaction or by a scent of an individual who encountered the food reward. The position in the social structure affects the efficacy of the social transfer of information; the effect depends on the prefrontal cortex integrity.

Usually, perceiving others' emotions is considered a capacity that helps to build relationships because it fosters emotional synchrony between individuals. Here we show that perceiving the affective states of others evoked by a reward helps an individual to adapt their behavior and maximize rewards. Thus, perceiving others' emotions carries informational value, which offers a new perspective on the evolutionary origins of socially shared emotions.

Septal mechanisms regulating social fear extinction: A role for neuropeptide signaling

Rohit Menon¹

¹University of Regensburg, Department of Behavior and Molecular Neurobiology, Universitätsstraße 31, 93053 Regensburg, Germany

Social anxiety disorder (SAD) is a debilitating psychopathology characterized by immense fear and avoidance of social situations. To study the neuronal mechanisms underlying SAD, we use the social fear conditioning (SFC) paradigm, which generates robust fear and avoidance of social stimulus in mice [1]. Using this paradigm, we have implicated the lateral septum (LS), which is rich in receptors for neuropeptides such as oxytocin (OXT), urocortin 3 (UCN3), and the corticotrophin-releasing factor (CRF), in regulating the extinction of SFC-generated social fear [2-4].

SFC induces robust social avoidance in male and female mice, while the physiological state of lactation, which is accompanied by an activation of the brain OXT signaling in female mice, leads to a lack of social fear expression despite successful social fear acquisition [2]. We have also shown that OXT is released in the LS of unconditioned (SFC-) male and female mice and conditioned (SFC+) lactating mice during extinction [2, 3]. Similar LS-OXT release is absent in the SFC+ male and female mice, suggesting dysregulation of their OXT system post-social fear acquisition [2, 3]. Indeed, infusion of OXT within the LS of SFC+ male and female mice reverses social fear. OXT mediates its effects via the OXT receptor (OXTR), which is expressed in high amounts within the LS, and pre-infusion of an OXTR-antagonist within the LS blocks the effect of OXT in male and female mice, while its infusion rescues social fear in lactating mice [2, 3]. Additionally, lactating mice with an activated brain OXT signaling do not express social fear during extinction, despite successful acquisition of day 1 of the SFC paradigm. We have also shown that the lack of social fear expression in mice during lactation depends on the activity of a bunch of LS-projecting magnocellular OXTergic neurons originating in the SON [2]. We have now studied the LS extensively and found that OXTR-expressing cells are concentrated within the caudal part of the LS (cLS) and that their primary downstream target is the medial habenula (MHb). Current studies are focussed on studying the role of this cLSOXTR – MHb circuit in mediating the social fear expression inhibiting effect of OXT.

The LS is also rich in CRFR2. However, the cells expressing CRFR2 are concentrated in the rostral part of the LS (rLS) [5]. These cells receive heavy input from the UCN3 expressing neurons within the medial amygdala (MeA), and our data shows that Stresscopin-mediated activation of rLSCRFR2 cells enhances while Astressin 2 β - mediated inhibition of rLSCRFR2 does not alter the extinction of social fear. Additionally, a significant trans-extinction increase in plasma-CORT levels in the SFC+ mice compared to the SFC- mice suggest that rLSCRFR2 mediated activation of the HPA axis might lead to enhancement of extinction. Current studies focus on linking the activity of rLSCRFR2 with the HPA axis alterations observed during the extinction of social fear. Additionally, we also aim to analyze the possible link between the OXT and CRF neuropeptide signaling within the LS in the regulation of social fear extinction using lactating mice as a model for activated OXT-signaling and dampened HPA-axis response to stressful stimuli.

1. Toth, I., I.D. Neumann, and D.A. Slattery, Social fear conditioning as an animal model of social anxiety disorder. *Curr Protoc Neurosci*, 2013. Chapter 9: p. Unit9 42.

2. Menon, R., et al., Oxytocin Signaling in the Lateral Septum Prevents Social Fear during Lactation. *Curr Biol*, 2018. 28(7): p. 1066-1078 e6.
3. Zoicas, I., D.A. Slattery, and I.D. Neumann, Brain oxytocin in social fear conditioning and its extinction: involvement of the lateral septum. *Neuropsychopharmacology*, 2014. 39(13): p. 3027-35.
4. Menon, R., et al., Neurobiology of the lateral septum: regulation of social behavior. *Trends Neurosci*, 2022. 45(1): p. 27-40.
5. Anthony, T.E., et al., Control of stress-induced persistent anxiety by an extra-amygdala septohypothalamic circuit. *Cell*, 2014. 156(3): p. 522-36.

Regulation of social behaviors by the lateral septum

Francisco Javier de los Santos Bernal, Robson Scheffer Teixeira², Letizia Moscato¹,
Hanna van den Munkhof^{1,2}, Haena Choi^{1,2}, Tatiana Korotkova^{1,2}

¹Medical Faculty, University of Cologne, Institute for Vegetative Physiology, Robert-Koch Str. 39, 50931 Cologne, Germany, ²Max Planck Institute for Metabolism Research, Gleueler Str. 50, 50931 Cologne, Germany

Social behaviors, conflictive or cooperative, are crucial for the survival and reproduction. Neural circuit mechanisms underlying the regulation of various social behaviors remain largely elusive. Further, little is known about how the brain computes choices when competing stimuli for mutually exclusive behaviors occur simultaneously. Aggression and feeding-related behaviors are regulated by the lateral septum (LS), which is connected with hypothalamic areas, the prefrontal cortex and hippocampus. We previously showed that somatostatin-expressing (Sst) neurons in the LS promote food-seeking (Carus-Cadavieco et al., Nature 2017). Here we investigated functions of two cell populations in the LS, Sst-, and neurotensin-expressing (NT) cells, in social and feeding-related behaviors. Combining opto-, chemogenetics and calcium imaging in behaving mice, we found differential neuronal activity in the LS selectively changing during different stages of social behaviors. Optogenetic activation of NT cells resulted in increased social interaction, accompanied by decreased dominant behavior towards conspecifics. At the same time, opto- or chemogenetic activation of NT cells in the LS decreased food intake, also in the absence of conspecifics. Subsecond analysis of behavior using MoSeq, an unsupervised machine learning algorithm revealed changes of multiple behavioral modules on a subsecond scale upon chemogenetic activation of NT cells. Conversely, optogenetic activation of Sst cells in LS decreased social interactions. Taken together, our results suggest that Sst- and NT-expressing populations in LS complementary regulate multiple aspects of innate behaviors.

We gratefully acknowledge support by the ERC Consolidator Grant (772994, FeedHypNet, to T.K.) and DFG (SFB1089 and EXC2030-CECAD, to T.K., 233886668-GRK1960, to F.S.).

The link between body-brain interaction and social behavior

Soyoung Q Park^{1,2,3}

¹German Institute of Human Nutrition Potsdam-Rehbrücke, Decision Neuroscience and Nutrition, Arthur-Scheunert-Allee 114-116, 14558 Nuthetal, Germany

²Charité-Universitätsmedizin Berlin, Corporate Member of Freie Universität Berlin, Humboldt-Universität zu Berlin and Berlin Institute of Health, Neuroscience Research Center, 10117 Berlin, Germany

³German Center for Diabetes Research(DZD), München-Neuherberg, 85764 München, Germany

As social beings living in close interaction, humans are in constant information exchange with others. Even while making non-social choices, such as consumer choice, humans take into account social information. On the other hand, bodily processes, such as nutrition and metabolism can impact social behavior. Here, I briefly review our own recent studies from the lab in which we investigate whether and how humans integrate information provided by others to make decisions. Specifically, I introduce a series of experiments in which either implicit (gaze-cue) and explicit (advice) social information were provided. Furthermore, I provide some data on how nutrition can change social behavior.

Symposium

S10: Membrane trafficking processes and presynaptic proteostasis

[S10-1](#) Mechanisms of local synaptic autophagy via trafficking of ATG-9
Daniel Alfonso Colón-Ramos

[S10-2](#) Survival-independent roles of neuronal autophagy
Natalia L. Kononenko

[S10-3](#) Amphisome biogenesis, trafficking and signaling at presynaptic boutons
Anna Karpova, Ahmed. A. Aly, Maria Andres-Alonso, Michael R. Kreutz

[S10-4](#) Defective axonal transportation of a contact site protein causing neurodegeneration in zebrafish
Vranda Garg, Torben Ruhwedel, Wiebke Moebius, Philip Hehlert, Ralf Heinrich, Roshan Priyarangana Perera, Patricia Scholz, Till Ischebeck, Ivo Feussner, Jacob Engelmann, Martin Goepfert, Roland Dosch, Bart Geurten

[S10-5](#) Autophagy controls ER calcium stores to regulate neurotransmission
Marijn Kuijpers

Mechanisms of local synaptic autophagy via trafficking of ATG-9

Daniel Alfonso Colón-Ramos¹

¹Yale University School of Medicine, Neuroscience, 260 Whitney Avenue, 06511 New Haven, USA

In neurons, macroautophagy occurs preferentially near synapses and responds to increased neuronal activity states. How synaptic autophagy is coupled to the neuronal activity state, and how its assembly is subcellularly compartmentalized to synapses is poorly understood. Through genetic approaches we find that ATG-9, the only transmembrane protein in the core autophagy pathway, is transported from the trans-Golgi network to synapses in *C. elegans* via the AP-3 complex. At synapses ATG-9 undergoes exo-endocytosis in an activity-dependent manner. Mutations that disrupt the endocytosis pathway, including a mutation associated with early onset Parkinsonism (EOP), lead to abnormal ATG-9 accumulation into subsynaptic clathrin-rich foci, and defects in activity-induced synaptic autophagy. From forward genetic screens, we also identified a role for the long isoform of the active zone protein Clarinet (CLA-1L) in regulating trafficking of autophagy protein ATG-9 at synapses, and presynaptic autophagy. CLA-1L extends from the active zone to the periaxonal zone, and genetically interacts with periaxonal zone proteins required for clathrin-dependent endocytosis. Our findings link ATG-9 regulation by synaptic proteins to autophagosome biogenesis, and suggest a mechanism whereby exo-endocytosis of ATG-9 links the activity-dependent synaptic vesicle cycle with autophagosome formation at synapses.

Survival-independent roles of neuronal autophagy

Natalia L. Kononenko¹

¹University of Cologne, Medical faculty and University Hospital, Center for Physiology and Pathophysiology & CECAD, Joseph-Stelzmann str. 26, 50931 Cologne, Germany

Autophagy provides nutrients during starvation and eliminates detrimental cellular components. However, accumulating evidence indicates that autophagy is not merely a housekeeping process. Here, by using neuronal-confined mouse models of ATG5 deficiency in either excitatory or inhibitory neurons and a combination of SILAC and label-free quantitative proteomics, high-content microscopy, and live-imaging approaches, we show that the protein AuTophagy 5 (ATG5) functions in neurons to regulate the cAMP-dependent protein kinase A (PKA)-mediated phosphorylation of a synapse-confined proteome. This function of ATG5 is independent of bulk turnover of synaptic proteins and requires the targeting of PKA inhibitory R1 subunits to autophagosomes. Neuronal loss of ATG5 causes synaptic accumulation of PKA R1, which sequesters the PKA catalytic subunit and diminishes the cAMP/PKA-dependent phosphorylation of postsynaptic cytoskeletal proteins mediating AMPAR trafficking. Glutamatergic neurons-confined ATG5 deletion augments AMPAR-dependent excitatory neurotransmission and causes the appearance of spontaneous recurrent seizures in mice. Our findings identify a novel role of autophagy in regulating PKA signaling at glutamatergic synapses and suggest the PKA as a target for restoration of synaptic function in neurodegenerative conditions with autophagy dysfunction.

Amphisome biogenesis, trafficking and signaling at presynaptic boutons

Anna Karpova^{1,4}, Ahmed. A. Aly^{1,2}, Maria Andres-Alonso^{1,3}, Michael R. Kreutz^{1,3,4,5}

¹Leibniz Institute for Neurobiology, RG Neuroplasticity, Magdeburg, Germany

²Leibniz Institute for Neurobiology, Neuronal Network; Magdeburg, Germany

³Center for Molecular Neurobiology (ZMNH), University Medical Center Hamburg-Eppendorf, Leibniz Group 'Dendritic Organelles and Synaptic Function', Hamburg, Germany.

⁴Center for Behavioral Brain Sciences, Otto von Guericke University; Magdeburg, Germany.

⁵German Center for Neurodegenerative Diseases (DZNE); Magdeburg, Germany.

The complex morphology of neurons, the specific requirements of synaptic neurotransmission and the accompanying metabolic demands create a unique challenge for proteostasis. Sophisticated mechanisms must, therefore, ensure efficient delivery of newly synthesized proteins and removal of faulty proteins. These requirements are most prominent at presynaptic sites, where the demands for protein turnover are especially high due to synaptic vesicle release and recycling that induces protein damage and where the replacement of material is hampered by the extreme length of the axon. Two major pathways, autophagy and the endolysosomal system contribute to presynaptic protein turnover and presynaptic function. Autophagosomes fuse with late endosomes to undergo robust retrograde transport and the resulting amphisomes serve as signaling and sorting platforms while trafficking in a retrograde direction to the cell soma. We will discuss the molecular makeup of the amphisome, long-distance in vitro and in vivo amphisome trafficking, which synaptic processes contribute to amphisome formation and the impact of amphisome signaling on presynaptic function.

Defective axonal transportation of a contact site protein causing neurodegeneration in zebrafish

Vranda Garg, Torben Ruhwedel², Wiebke Moebius², Philip Hehlert¹, Ralf Heinrich¹, Roshan Priyarangana Perera³, Patricia Scholz⁴, Till Ischebeck⁴, Ivo Feussner⁴, Jacob Engelmann⁵, Martin Goepfert¹, Roland Dosch³, Bart Geurten¹

¹Department of Cellular Neurobiology, University of Goettingen, Goettingen, Germany.

²Department of Neurogenetics, Max-Planck Institute of Experimental Medicine, Göttingen, Germany.

³Department of Developmental Biochemistry, University of Goettingen, Goettingen, Germany.

⁴Department of Plant Biochemistry, Albrecht-von-Haller-Institute, GZMB, Göttingen, Germany.

⁵Active Sensing, Faculty for Biology, Bielefeld University, Bielefeld, Germany

Defects in the transportation of proteins and organelles from the cell body to the axonal terminal is one of the major causes of length dependent axonopathy in corticospinal neurons. In the present study, we have used zebrafish as a model to investigate the role of an outer mitochondrial membrane gene, *tomm70*, in neurodegenerative disorder Hereditary Spastic Paraplegia (HSP), in which people suffer from lower limb motility defects. HSP is caused by mutations of about 80 different genes. Recently, one of the candidate genes, *tomm70*, has also been found to be a part of the membrane contact site between mitochondria and endoplasmic reticulum (ER) where it interacts with an ER protein called Lam6. Using the BiFC assay in zebrafish embryos, we found that a single base change in the *tomm70* gene leads to a partial loss of interaction between Tomm70 and Lam6. To study the effect of mutation in the nervous system of adult fish, we used primary neuronal cell culture and immunocytochemistry techniques and found that the protein accumulates in the soma and thereby not getting transported to the long axons of the brain neurons. We observed the dysfunctionality of these neurons, also in the locomotion of adult fish. We found that the mutant fish not only have defects in their normal and startle induced swimming but also in bending the lower portion of their body. As a common feature of neurodegeneration, we have also found demyelination in the large caliber axons of the spinal cord of mutants. Here, we present *tomm70* as a novel gene for HSP and simultaneously delineate the underlying mechanism of this rare and complex neurodegenerative disorder.

Autophagy controls ER calcium stores to regulate neurotransmission

Marijn Kuijpers¹

¹Radboud University and Donders Institute for Brain, Cognition and Behaviour, Department of Molecular Neurobiology, Heyendaalseweg 135, 6525 AJ NIJMEGEN, Netherlands

Neurons rely on autophagy for removal of defective proteins or organelles to maintain synaptic neurotransmission and counteract neurodegeneration, yet the physiological substrates of neuronal autophagy have remained largely elusive. We use knockout mice conditionally lacking the essential autophagy protein ATG5 to demonstrate that loss of neuronal autophagy causes selective accumulation of tubular endoplasmic reticulum (ER) in axons and an increase in excitatory neurotransmission. Calcium imaging experiments show that ATG5 KO neurons suffer from altered calcium homeostasis and an increased ER-calcium release through ER-localized ryanodine receptors (RYR) that accumulate in autophagy-deficient axons. We propose a model where neuronal autophagy controls axonal ER calcium stores to regulate release probability and neuronal excitability.

Symposium

S11: Neuroscience of naturalistic navigation and foraging in non-human primates

[S11-1](#) Closed-loop neuroethology in freely ranging mouse lemurs

Daniel Huber, Ali Nourizonos

[S11-2](#) Active sensing and flexible neural coding during visually guided virtual navigation

Dora Angelaki

[S11-3](#) The Exploration Room (ExR) – a novel environment for neurophysiological recordings in freely moving rhesus macaques exhibiting ecologically relevant behaviors

Zurna Ahmed, Irene Lacal, Richard Vogg, Matthias Nuske, Neda Shahidi, Florentin Wörgötter, Alexander Ecker, Alexander Gail

[S11-4](#) New approaches to the study of sensorimotor basis of foraging behavior in non-human primates

Irene Lacal, Neda Shahidi, Zurna Ahmed, Alexander Gail

[S11-4](#) New approaches to the study of sensorimotor basis of foraging behavior in non-human primates

Neda Shahidi, Irene Lacal, Zurna Ahmed, Alexander Gail

[S11-5](#) Timescales of behaviour and neural processing in unconstrained macaques

Jan Zimmermann

Closed-loop neuroethology in freely ranging mouse lemurs

Daniel Huber¹, Ali Nourizonos²

¹University of Geneva, Department of Basic Neurosciences, Rue Michel Servet 1, CH-1206 Geneva, Switzerland

Accurate tracking and analysis of animal behavior is crucial for modern systems neuroscience. Animals can be easily monitored in confined, well-lit spaces or virtual-reality setups. However, tracking freely moving behavior through naturalistic, three-dimensional environments remains a particular challenge in primates. Closed-loop control providing behavior-triggered stimuli, is also more complicated in free-range settings. Here, we present EthoLoop (www.etholoop.org): a framework for studying the neuroethology of freely roaming primates.

Combining real-time optical tracking, “on-the-fly” behavioral analysis with remote-controlled stimulus-reward boxes, allows us to directly interact with free-ranging mouse lemurs in their habitat. We show that this closed-loop optical tracking system can be used to follow the 3D spatial position of multiple subjects in real time, continuously provide close-up views, and condition behavioral patterns detected online with deep learning methods. Reward or stimulus feedback is provided by battery-powered and remote-controlled devices that communicate with the tracking system and can be positioned at multiple locations in the environment.

Using the EthoLoop system in combination with wireless recording techniques, we were not only able to reveal the first 3D place cells in primates, but also demonstrate that complex behaviors, such as jumping from branch to branch, can be studied in a quantitative and highly reproducible manner. Taken together, the EthoLoop framework enables a new generation of interactive, but well-controlled and reproducible neuroethological studies with primates in large-field naturalistic settings.

Active sensing and flexible neural coding during visually guided virtual navigation

Dora Angelaki¹

¹New York University, Center for Neural Science, 4 Washington Pl, 10003 New York, USA

We will summarize two aspects of naturalistic visually guided navigation.

First, the role of active sensing (gaze) in planning and memory. By analyzing the spatial distribution of human gaze to transiently visible goals in virtual mazes we found that environmental complexity mediated a striking tradeoff in the extent to which attention was directed towards two complimentary aspects of the world model: the reward location and task-relevant transitions. The temporal evolution of gaze revealed rapid, sequential prospection of the future path, evocative of neural replay. These findings suggest that the spatiotemporal characteristics of gaze during navigation are significantly shaped by the unique cognitive computations underlying real-world, sequential decision making.

Second, in a simplified navigation paradigm in monkeys, we explored how neural nodes operate within the recurrent action-perception loops that characterize naturalistic self-environment interactions and how brain networks reconfigure during changing computational demands. Here, we record spiking activity and LFPs simultaneously from the dorsomedial superior temporal area (MSTd), parietal area 7a, and dorsolateral prefrontal cortex (dlPFC) as monkeys navigate in virtual reality to “catch fireflies”. This task requires animals to actively sample from a closed-loop visual environment while concurrently computing latent variables: the evolving distance and angle to a memorized goal. We observed mixed selectivity in all areas, with even a traditionally sensory area (MSTd) tracking latent variables. Strikingly, global encoding profiles and unit-to-unit coupling suggested a functional subnetwork between MSTd and dlPFC, and not between these areas and 7a, as anatomy would suggest. When sensory evidence was rendered scarce, lateral connectivity through neuron-to-neuron coupling within MSTd strengthened but its pattern remained fixed, while neuronal coupling adaptively remapped within 7a and dlPFC. The larger the remapping in 7a/dlPFC and the greater the stability within MSTd, the less was behavior impacted by loss of sensory evidence. These results highlight the distributed nature of neural coding during closed-loop action-perception naturalistic behaviors and suggest internal models may be housed in the pattern of fine-grain lateral connectivity within parietal and frontal cortices.

The Exploration Room (ExR) – a novel environment for neurophysiological recordings in freely moving rhesus macaques exhibiting ecologically relevant behaviors

Zurna Ahmed, Irene Lacal¹, Richard Vogg⁵, Matthias Nuske⁷, Neda Shahidi^{1,3}, Florentin Wörgötter^{3,7}, Alexander Ecker^{3,5,6}, Alexander Gail^{1,2,3,4}

¹Sensorimotor Group, German Primate Center, Göttingen, Germany

²Faculty of Biology and Psychology, University of Göttingen, Göttingen, Germany

³Leibniz ScienceCampus Primate Cognition, Göttingen, Germany

⁴Bernstein Center for Computational Neuroscience, Göttingen, Germany

⁵Institute of Computer Science and Campus Institute Data Science, University of Göttingen, Göttingen, Germany

⁶Max Planck Institute for Dynamics and Self-Organization, Göttingen, Germany

⁷Department for Computational Neuroscience, Third Physics Institute, University of Göttingen, Göttingen, Germany

Systems neuroscience in rhesus monkeys (*macaca mulatta*) widely uses computer-based tasks and tethered neural recordings requiring chair-seating and head movement constraints. Yet, restricted mobility limits the study of sensorimotor and decision-making processes during complex ecologically relevant behaviors like foraging or interaction with others. Existing setups for wireless neural recording in freely moving macaques are of limited size and suited for short-range full-body movements or treadmill walking only. Larger environment that combine detailed motion capture with neural recordings during versatile goal-directed full-body behaviors remain a challenge.

We present a novel, highly modular, large-scale experimental setup for neurophysiological recordings in freely moving macaques called the Exploration Room (ExR). The ExR is 4.3 x 2.6 x 2.5 m³ (W x D x H) large and suited for one or more animals simultaneously within the same compartments. Alternatively, the room can be divided into two symmetrical halves using a motorized room divider or an animal can observe others from within a transparent viewing compartment. Walls and floor panels can be exchanged individually against functional elements, like computer-controlled interactive feeders, or touchscreen kiosk systems (XBI).

We demonstrate the ExR's modularity and suitability for studying both, free and highly variable full-body movements, as well as well-controlled, trial-based repetitive behaviors. As an example, we highlight continuous foraging with complex, yet repetitive behaviors in an environment with 36 potential food or fluid sources (patches) including flexible branches, XBIs, hollow toys, and litter piles (Playground Experiment, PE).

Up to 18 synchronized high-definition cameras (1.3 Mpix resolution, 170 fps) can be mounted in the ExR using custom-designed, adjustable, animal-proof chassis for tracking of the animals (ExplorEyes; ExE). We illustrate how a novel combination of markerless full-body 3D-keypoint tracking with 2D-pose estimation allows identification of "transition" behaviors during patch switching and patch-interaction behaviors using only a few cameras. We demonstrate how established data analysis methods can be applied on the extracted repetitive patterns from a continuous behavioral stream.

We provide proof-of-concept wireless neural recordings at single neuron resolution obtained during PE across multiple areas of the frontoparietal reach network. We present neural data of complex behaviors, like reaching during a 2-leg-stand, which were not accessible so far. As an example of patch switching, we apply

single-trial analysis on 3D-tracked transition behavior to identify the point of commitment and the associated neural activity. As an example for patch interaction, we compare reaches during different patch-specific postures and their neural correlates in cortical sensorimotor areas.

In summary, the ExR is suited for a wide range of paradigms ranging from trial-based repetitive to free continuous, behaviors with high ecological relevance. We propose combinations of behavioral tracking methods for which few cameras are sufficient and which offer the possibility to apply established analytical methods to overcome the challenge of analyzing continuous behavior. The ExR substantially extends the possibilities in systems neuroscience as it allows studying neural correlates of complex, ecologically relevant full-body behaviors, including the cognition of interaction.

New approaches to the study of sensorimotor basis of foraging behavior in non-human primates

Neda Shahidi^{1,2}, Irene Lacal¹, Zurna Ahmed^{1,3}, Alexander Gail^{1,2,3,4}

¹Sensorimotor Group, German Primate Center, Goettingen, Germany

³Faculty for Biology and Psychology, University of Goettingen, Germany

²Leibniz ScienceCampus Primate Cognition, Goettingen, Germany

⁴Bernstein Center for Computational Neuroscience Goettingen, Germany

Rhesus monkeys (*macaca mulatta*) are an important animal model in systems neuroscience. Computer-based tasks are typically used for testing chair-seated monkeys, whose head movements are restraint for allowing tethered electrophysiological recordings. With this approach it was repeatedly demonstrated that action goals are dynamically represented in primate sensorimotor cortex during movement planning and execution as well observing and anticipating actions of other intentional agents.

To which extent these findings can be generalized to more complex, ecologically-relevant contexts like choices during the course of an ongoing action, foraging or during social interactions remains unknown. To improve our understanding of the sensorimotor basis of naturalistic behaviors, we developed a modular experimental setup, the Exploration Room (ExR), which enables us to conduct a variety of experiments to address these open questions.

This novel, highly modular, large-scale experimental setup for neurophysiological recordings in freely moving macaques is a 4.3m x 2.6m x 2.5 m (W x D x H) enclosure suited for single animal as well multi-animal testing within the same physical space or separated by a motorized room divider for dyadic setting. The modular walls and floor panels allow easy exchange and mount of interactive devices to customize the environment depending on the experimental needs. Up to 18 cameras can be safely mounted inside the ExR using our custom-designed, animal-proof chassis (ExplorEye). This allows markerless full-body tracking and offline 3D reconstruction as well as neural recordings with wireless or data logging system (up to 256 channels at high- bandwidth).

Five monkeys were familiarized to the ExR and engaged in two types of experiments.

The first experiment was a trial-based walk-and-reach task where monkeys could choose between reaching one out of two alternative targets based on the associated payoff. A go-before-you-know (GBYK) paradigm was adopted such as a change in color of the two targets instructed the animal about the reward associated to each option at a randomly defined latency after the movement start. The results show that monkeys can learn to reliably perform repetitive, goal-directed movements in a trial-wise fashion with high motivation under conditions of minimal constraints. Moreover, the animals were able to adjust dynamically their choice strategy to optimize their reward gain and effort.

In the dyadic foraging experiment, a monkey and a human, separated by a transparent wall, shared the platform to compete for four food pieces at a time alongside the separation wall. Consistent with our observation in the GBYK experiment, the monkey adjusted its choices, according to the human's choice, to gain the maximum number of food pieces while avoiding potential conflict of interests with the human.

Taken together, these results demonstrate that our modular ExR environment is well suited for studying the cognitive and sensorimotor basis of complex and naturalistic behaviors in freely moving rhesus macaques while exerting variable degrees of experimental control, opening new possibilities for neuroscientific research on ecologically relevant behaviors.

Timescales of behaviour and neural processing in unconstrained macaques

Jan Zimmermann¹

¹University of Minnesota, Department of Neuroscience, 2021 6th Street SE, 55455 Minneapolis, USA

Behavior is organized across multiple spatial and temporal scales, ranging from sub-second motor commands over multi-second movement plans to long term foraging patterns. Currently it is unclear how the brain solves this coordination of multiple intertwined temporal demands. While classical neuroscience experiments typically look at or engage a fixed temporal scale or horizon, ethological studies have long focused on the analysis of naturalistic behavior across freely elicited temporal scales. Here I will show some of the approaches my lab is taking to understand the organization of timescales in behavior and neural processing ranging from ultra high field fMRI to multi-region wireless electrophysiology in freely moving rhesus macaques.

Symposium

S12: Epileptogenesis in mouse models of genetic epilepsies

[S12-1](#) Developmental windows of opportunity in mouse models of genetic epilepsies
Dirk Isbrandt, Andrea Merseburg

[S12-2](#) Brain-region specific epileptogenesis in Dravet syndrome
Thomas V. Wuttke

[S12-3](#) Aberrant dendritic hyperexcitability and dendritic maturation of CA3 pyramidal cells in the SCN2A^{A263V} genetic epilepsy model.
Tony Kelly, Michela Barboni, Heinz Beck

[S12-4](#) KCNA2-encephalopathy: from bench to bedside
Ulrike B.S. Hedrich

[S12-5](#) NMDA-receptor-Fc-fusion constructs neutralize anti-NMDA receptor antibodies
Eleonora Anna Loi, Stephan Steinke, Toni Kirmann, Jana Nerlich, Iron Weichard, Philip Kuhn, Torsten Bullmann, Andreas Ritzau-Jost, Filiz Sila Rizalar, Harald Prüss, Volker Haucke, Christian Geis, Michael Hust, Stefan Hallermann

Developmental windows of opportunity in mouse models of genetic epilepsies

Dirk Isbrandt^{1,2}, Andrea Merseburg^{1,2}

¹DZNE, Experimental Neurophysiology, Venusberg-Campus 1/99, 53127 Bonn, Germany

²University of Cologne, Institute for Molecular and Behavioral Neuroscience, 50937 Cologne, Germany

Developmental and epileptic encephalopathies (DEE) are a genetically heterogeneous group of diseases with early age of onset and minimal treatment options, often resulting in lifelong burdens from developmental delay, intellectual disability, behavioral abnormalities, and seizures. About one-quarter of genes associated with DEEs encode ion channels, receptors, and other membrane transport proteins. We seek to identify the molecular, cellular, and network mechanisms during brain development underlying epileptogenesis in genetic channelopathy mouse models. While specifically, the developing brain is susceptible to perturbations and insults, its plasticity also suggests a considerable preventive and therapeutic potential. Notably, in addition to the seizure phenotypes in DEEs, there are also frequent comorbid neurodevelopmental phenotypes with potentially overlapping vulnerable periods that include motor and language delay, intellectual disability, attention-deficit/hyperactivity disorder (ADHD), and autism spectrum disorder (ASD).

Using transgenic mice with inducible and reversible suppression of HCN/h-currents or mice carrying human patient-derived mutations in HCN1 or SCN2A, which underwent a multi-level analysis including the characterization of molecular, brain structural, and behavioral changes, and quantification of in vivo network activities in cortex, hippocampus, and striatum, we identified both common and model-specific phenotypic changes.

As an example, the phenotypes caused by loss of HCN/h-currents strongly depended on the developmental period during which it was present and ranged from microcephaly following the loss of embryonic h-current to delayed and impaired motor development, and persistent locomotor hyperactivity and stereotypies in adulthood following the early postnatal loss of h-currents. Mice with a life-long expression of a patient-derived HCN1 DEE mutation developed in addition to epilepsy, also behavioral deficits, and structural brain abnormalities.

Here, we will discuss our findings on how disturbed neural network development in channelopathies, through mutation-specific changes in intrinsic neuronal properties, alters neuronal and network excitability, affects the structural and functional maturation of developing cortical and subcortical networks to cause persistent functional and structural changes underlying epilepsy and its comorbidities.

Brain-region specific epileptogenesis in Dravet syndrome

Thomas V. Wuttke^{1,2}

¹Department of Neurology and Epileptology, Hertie Institute for Clinical Brain Research, University of Tübingen.

²Department of Neurosurgery, University of Tübingen.

Dravet syndrome (DS) is a severe developmental and epileptic encephalopathy characterized by pharmacoresistant epileptic seizures with an onset during the first 2 years of life, neurodevelopmental delay, cognitive decline and impaired motor skills. DS is mainly caused by de novo loss-of-function variants in the voltage-gated sodium ion channel $Na_v1.1$, encoded by the *SCN1A* gene and linked dysfunctional action potential initiation of fast-spiking interneurons. However, these findings alone can hardly explain the entire phenotypic disease spectrum. Emergence of symptoms during early-childhood including neurodevelopmental deficits suggest that not yet completed refinement and maturation of CNS circuitry may represent a particularly vulnerable and permissive phase for epileptogenic processes which are set off by the initial genetic hit. We are exploring these hypotheses in vivo by video-EEG recordings and in vitro on single neuron and network levels in distinct brain areas and within the context of different stages of developmental maturity. Our data identify first functional alterations as early as the pre-seizure disease stage and indicate brain-region specific vulnerability for the generation of certain seizure types. Underlying molecular mechanisms are being interrogated by transcriptomic analyses of defined brain areas and throughout the course of the disease. These studies may help to identify time windows of opportunity and new targets for therapeutic intervention.

Aberrant dendritic hyperexcitability and dendritic maturation of CA3 pyramidal cells in the SCN2A^{A263V} genetic epilepsy model.

Tony Kelly¹, Michela Barboni¹, Heinz Beck¹

¹University of Bonn, IEECR, Life & Brain, Sigmund-Freud Str. 25, 53127 Bonn, Germany

Gain-of-function (GOF) variants of the Na_v1.2 sodium channel strongly associate with a range of developmental disorders with epilepsy as a common feature. Although previous studies in heterologous expression systems have identified the biophysical mechanism underlying the GOF, not well understood is how a GOF mutation alters cellular and synaptic properties during development. We studied the cellular excitability and dendritic integration in CA3 pyramidal neurons during early postnatal (PN10-PN14) and later postnatal (PN24-PN28) developmental stages in the SCN2A^{A263V} mouse model of genetic epilepsy using patch clamp recordings and simultaneous glutamate iontophoresis.

Our data show an abnormal transient somatic hyperexcitability in SCN2A^{A263V} mutant animals during early development that reverses later. We next investigated how dendritic excitability and morphology develop over CA3 pyramidal cell maturation. In early development, CA3 dendrites from wt animals exhibit largely linear increases in EPSP amplitudes, while later in development dendrites express dendritic spikes (d-spikes) with a distinctive fast phase characteristic of mature CA3 pyramidal cells. In addition, CA3 dendritic morphology developed a characteristic thorny appearance later in development. In contrast, in SCN2A^{A263V/wt} animals, dendrites were capable of aberrant d-spikes in early development. Later in development in mutant animals, CA3 dendrites did not develop the characteristic fast d-spikes, seen in wt animals, and the majority of CA3 dendrites remained athorny.

Taken together, our data indicate that aberrant dendritic hyperexcitability during early developmental stages may alter the maturation of CA3 pyramidal neurons in the SCN2A^{A263V} model of genetic epilepsy.

KCNA2-encephalopathy: from bench to bedside

Ulrike B.S. Hedrich¹

¹Hertie-Institute for Clinical Brain Research, Dept. of Neurology and Epileptology, Otfried-Mueller-Str. 27, 72076 Tuebingen, Germany

Developmental and epileptic encephalopathies (DEE) are devastating disorders characterized by epilepsy, intellectual disability, and other neuropsychiatric symptoms, for which available treatments are largely ineffective. Variants in the *KCNA2* gene encoding the voltage-gated potassium channel subunit K_V1.2 have been identified as a cause of DEE, and functional studies using heterologous expression systems have revealed first insights into protein dysfunction. Recently, our group has identified variants in *KCNA2* causing either milder focal (loss of function, LOF) or more severe generalized (gain of function, GOF) types of DEE. However, the exact mechanisms underlying disease progression remain unknown, thereby hampering development of new effective treatment strategies for these patients.

We therefore investigated the effects of 4-Aminopyridine (4-AP), a relatively specific blocker of KV1 channels, and could show that 4-AP can antagonize gain-of-function defects caused by variants in the K_V1.2 subunit *in vitro* in *Xenopus laevis* oocytes, by reducing current amplitudes and negative shifts of steady-state activation and increasing the firing rate of transfected neurons.

Based on these results, we treated 11 patients carrying GOF-variants with 4-AP in different centers worldwide. Patients suffering from daily absence, myoclonic, or atonic seizures became seizure-free, some of them also showed marked improvement in generalized tonic-clonic seizures. In addition, gait, ataxia, alertness, cognition, or speech improved during 4-AP treatment, which was well tolerated by the patients suggesting a promising tailored treatment in *KCNA2*-(GOF)-encephalopathy.

To better understand the effect of *KCNA2* variants on neuronal properties and networks as well as compensatory and disease-specific mechanisms and enable tailored treatment, we developed *Kcna2* knock-in mouse models for both GOF and LOF variants. Both models represent the clinical phenotype of patients with focal seizures in LOF animals and more severe generalized seizures in GOF animals. Both GOF and LOF knock-in mice died prematurely between one and two months of age, with a highly increased mortality rate in the GOF mouse model. Treatment of these animals with 4-AP via drinking water could significantly prolong the survival time of the animals. Currently, we examine the underlying molecular mechanisms by transcriptomic analysis of specific brain regions throughout the course of the disease and develop new treatment options for patients suffering from this devastating disorder.

NMDA-receptor-Fc-fusion constructs neutralize anti-NMDA receptor antibodies

Eleonora Anna Loi, Stephan Steinke², Toni Kirmann³, Jana Nerlich³, Iron Weichard³, Philip Kuhn⁴, Torsten Bullmann³, Andreas Ritzau-Jost³, Filiz Sila Rizalar^{5,6}, Harald Prüss^{7,8}, Volker Haucke^{5,6}, Christian Geis¹, Michael Hust², Stefan Hallermann³

¹Section Translational Neuroimmunology, Hans-Berger Department for Neurology, Jena University Hospital, Am Klinikum 1, 07747 Jena, Germany

²Technische Universität Braunschweig, Institut für Biochemie, Biotechnologie und Bioinformatik, Abteilung Medizinische Biotechnologie, Spielmannstr. 7, 38106 Braunschweig

³Carl-Ludwig-Institute of Physiology, Faculty of Medicine, Leipzig University, 04103 Leipzig, Germany

⁴YUMAB GmbH, Inhoffenstr. 7, 38124 Braunschweig, Germany Proteins, Inhoffenstr. 7, 38124 Braunschweig, Germany

⁵Leibniz-Forschungsinstitut für Molekulare Pharmakologie (FMP), Berlin, Germany

⁶Faculty of Biology, Chemistry, Pharmacy, Freie Universität Berlin, 14195 Berlin, Germany

⁷German Center for Neurodegenerative Diseases (DZNE) Berlin, 10117 Berlin, Germany

⁸Department of Neurology and Experimental Neurology, Charité-Universitätsmedizin Berlin, Berlin, Germany

N-methyl-D-aspartate receptor (NMDAR) encephalitis is the most common subtype of autoimmune encephalitis characterized by a complex neuropsychiatric syndrome ranging from memory impairment and psychosis to coma. Patients develop an intrathecal immune response against NMDARs with antibodies that presumably bind to the amino-terminal domain (ATD) of the GluN1 subunit. The therapeutic response to immunotherapy, e.g. Rituximab, is often delayed and does not directly interfere with the intrathecal synthesis of pathogenic antibodies by plasma cells. Therefore, new therapeutic approaches for fast neutralization of NMDAR antibodies are needed.

Here, a fusion protein consisting of the Fc part of immunoglobulin G and the ATDs of either or both GluN1 and GluN2B subunits were engineered. The pathogenic anti-NMDAR autoantibodies bind to the GluN1-GluN2B-Fc fusion construct shown by ELISA. Remarkably, both subunits were required to generate high-affinity epitopes.

The GluN1-GluN2B-Fc fusion protein was tested in a series of experiments to evaluate the ability to prevent the pathological effect of anti-NMDAR IgG. The blocking of NMDAR internalization was demonstrated by confocal imaging in rodent cultured neurons incubated with monoclonal IgG and the fusion construct. Furthermore, the stabilization of NMDAR currents using the fusion protein and patient cerebrospinal fluid (CSF) was shown in electrophysiology experiments. Finally, Novel Object Recognition (NOR) behavioral test was performed in a mouse model of NMDAR encephalitis to test for memory impairment. Animals were intrathecally injected with patient-derived monoclonal antibodies alone, to induce the encephalitis phenotype, or in combination with the GluN1-GluN2B-Fc fusion protein. Then a NOR paradigm with a 3h retention time was used to test for short-term memory impairment.

We proved, that the GluN1-GluN2B-Fc fusion protein reduces the internalization of NMDARs induced by pathogenic IgG binding. Furthermore, the fusion protein rescues the phenotypical short-term memory impairment induced by patient-derived monoclonal antibodies in an *in vivo* mouse model of NMDAR encephalitis.

Our results demonstrate that both GluN1 and GluN2B subunits contribute to the main immunogenic region of the NMDAR and the GluN1-GluN2B-Fc fusion construct proved able to rescue the pathogenic effects of

NMDAR antibodies, providing a promising strategy for fast and specific treatment of NMDAR encephalitis, which can complement the current immunotherapy.

Symposium

S13: Breaking News

- [S13-1](#) Hormone-mediated neural remodelling orchestrates parenting onset during pregnancy
Francesco Monaca, Rachida Ammari, Mingran Cao, Patty Wai, Estelle Nassar, Johannes Kohl
- [S13-2](#) Characterization of descending and modulatory neurons enabling adaptive walking in *Drosophila*
Fathima Mukthar Iqbal, Jan M. Ache
- [S13-3](#) *In vivo* investigation of novel channelrhodopsin variants for optogenetic activation of the auditory pathway by blue light
Lennart Roos, Aida Garrido Charles, Bettina Wolf, Kathrin Kusch, Thomas Mager, Tobias Moser
- [S13-4](#) Molecular alterations underlying hypotonia in SHANK3 deficiency
Berra Yildiz, Dr. Anne-Kathrin Lutz, Prof. Dr. Tobias Böckers
- [S13-5](#) Binge eating suppresses flavor representations in the mouse olfactory cortex
Hung Lo, Anke Schoenherr, Malinda L.S. Tantirigama, Laura Moreno Velasquez, Lukas Faiss, Benjamin Rost, Matthew Larkum, Benjamin Judkewitz, Katharina Stumpfenhorst, Marion Rivalan, York Winter, Dietmar Schmitz, Friedrich Jochenning
- [S13-6](#) Circadian regulation of trigeminal pain circuits
Florian Zirpel, Zameel Cader
- [S13-7](#) Regulation of social behaviour and anxiety by cortical inputs to lateral hypothalamus
Alisa Bakhareva, Anne Petzold, Tatiana Korotkova
- [S13-8](#) Limiting factors and regulatory consequences of cFos expression
Andreas Franzelin, Paul Lamothe-Molina, Margarita Anisimova, Chris E. Gee, Thomas G. Oertner
- [S13-9](#) An electrosensory cocktail party problem
Alexandra Barayeu, Maria Schlungbaum, Benjamin Lindner, Jan Grewe, Jan Benda
- [S13-10](#) A septal-VTA circuit drives exploratory behavior
Petra Mocellin, Kevin Luxem, Oliver Barnstedt, Hiroshi Kaneko, Dennis Daluegge, Falko Fuhrmann, Sanja Mikulovic, Stefan Remy

Hormone-mediated neural remodelling orchestrates parenting onset during pregnancy

Francesco Monaca, Rachida Ammari¹, Mingran Cao¹, Patty Wai¹, Estelle Nassar¹, Johannes Kohl¹

¹The Francis Crick Institute, State-dependent Neural Processing Laboratory, 1 Midland Road, NW1 1AT London, United Kingdom

Understanding how physiological states shape information processing in the brain is a fundamental question in neuroscience. Parenting is an instinctive behaviour the onset of which is assumed to be tightly linked to pregnancy-related hormonal fluctuations. While considerable progress has been made in dissecting the neural circuitry underlying parental behaviour in rodents and other species, very little is known about the modulation of this behaviour and its underlying circuits by female's reproductive state.

We find that parental interactions emerge during pregnancy, with the most pronounced changes occurring in late pregnancy. By also tracking parental interactions in (1) ovariectomised females and (2) pregnant females not repeatedly exposed to pups, we identify aspects of parenting that are affected by pregnancy hormones, rather than by sensitisation due to frequent pup exposure. Intriguingly, the effects of pregnancy on parental behaviour persist until one month after parturition, suggesting that they result from hormone-mediated (semi)permanent remodelling of the brain.

The medial preoptic area (MPOA) is a brain region crucial for parental behaviour, hormonal stimulation of which promotes parenting in virgins. To determine whether sensitivity of the MPOA to the pregnancy hormones estradiol and progesterone is required for pregnancy-induced onset of parental behaviour, we deleted their receptors from this region. We find that ablation of either estrogen or progesterone receptor abolishes pregnancy-induced improvement of parental performance. Strikingly, deletion of those receptors from galanin-expressing MPOA (MPOA^{Gal}) neurons, which constitute only ~20% of neurons in the MPOA, recapitulates the effects observed after MPOA-wide receptor ablation. Sensing of ovarian hormones by MPOA^{Gal} neurons is therefore necessary for the pregnancy-induced parenting onset.

We next probed the effects of pregnancy on MPOA^{Gal} activity *in vivo*. Performing longitudinal, cellular resolution calcium imaging from MPOA^{Gal} neurons in females exposed to pups and other social and non-social stimuli, we discover that the overall activity of MPOA^{Gal} neurons is reduced in pregnancy, and that tuning to parental behaviour is sparsened. In addition, selectivity to pups over other social stimuli is increased, and discriminability between sensory stimuli enhanced in late pregnancy. These results suggest that pregnancy reconfigures MPOA^{Gal} population activity, resulting in more efficient encoding of pup stimuli and parental actions.

Our work suggests that ovarian hormone action on MPOA^{Gal} neurons mediate preparatory behavioural adaptations during pregnancy.

Characterization of descending and modulatory neurons enabling adaptive walking in *Drosophila*

Fathima Mukthar Iqbal, Jan M. Ache¹

¹ Neurobiology and Genetics, Theodor-Boveri-Institute, Biocenter, Julius-Maximilians-University of Würzburg, Würzburg, Germany

Animals need to be able to flexibly adjust their walking behaviour in order to efficiently negotiate complex, dynamic environments. Although they are capable of flying, *Drosophila melanogaster* spend a large proportion of their active periods walking. Accordingly, they exhibit remarkable flexibility in walking behaviour. In flies, environmental sensory cues are integrated by brain circuits and conveyed to motor centers in the ventral nerve cord (VNC) through a bottleneck of only about 500 pairs of Descending Neurons (DNs). Thus, DNs constitute a key component of the neural substrate underlying adaptive locomotor behaviour. Along with changes in the environment, walking also needs to be adapted to changes in internal states to ensure survival and reproduction. For example, hungry animals display a much higher baseline locomotor activity since they tend to explore their environment while foraging for food. Such changes in locomotor activity can be elicited by release of various neuromodulators, which modify the outputs of different motor circuits.

Here, we performed an automated optogenetic activation screen of DNs and modulatory aminergic and peptidergic neurons in freely walking flies using a behavioral set up named 'Universal Fly Observatory (UFO)'. The UFO is based on earlier setups designed by the Dickinson, Branson and Büschges labs. The UFO features a walking arena surrounded by LED rings for optogenetic manipulation via the excitatory channelrhodopsin Cs Chrimson and the inhibitory channelrhodopsin GtACR1. Infrared background illumination is provided by a third LED ring. The entire arena is filmed from below with an IR-sensitive camera with a spatial resolution high enough to capture individual flies and appendages. For the present set of experiments, video frames were acquired at 20Hz. Using the UFO, we also quantified effects of environmental conditions (such as the background illumination or time of day) and the internal state on baseline locomotor activity. Basic walking parameters of individual flies were quantified using the 'Caltech Fly Tracker' software.

Out of the 46 DN split GAL4 lines and 13 neuromodulator lines we screened to date, 13 DN lines and 3 neuromodulator lines had strong effects on walking parameters. For example, we identified neuron types that affected curve-walking, initiated, and stopped walking. The locomotor phenotypes obtained from the screens will be further examined using behavioral set ups and quantitative approaches that allow for detailed kinematic analyses. The most interesting candidates identified in our screen will be further characterized using *in-vivo*-patch-clamp recordings and calcium imaging to enable a better understanding of how DNs and modulatory neurons enable adaptive walking behaviour in response to varying external conditions and internal states.

***In vivo* investigation of novel channelrhodopsin variants for optogenetic activation of the auditory pathway by blue light**

Lennart Roos, Aida Garrido Charles^{1,4,5}, Bettina Wolf^{1,4,6}, Kathrin Kusch^{1,7}, Thomas Mager^{1,4,5}, Tobias Moser^{1,2,3,4,6}

¹Institute for Auditory Neuroscience and InnerEarLab, University Medical Center Göttingen, 37075 Göttingen, Germany.

²Department of Otorhinolaryngology, University Medical Center Göttingen, 37075 Göttingen, Germany.

³Collaborative Research Center 889, University of Göttingen, Göttingen, Germany.

⁴Cluster of Excellence "Multiscale Bioimaging: from Molecular Machines to Networks of Excitable Cells" (MBExC), University of Göttingen, Göttingen, Germany.

⁵Advanced Optogenes Group, Institute for Auditory Neuroscience and InnerEarLab, University Medical Center Göttingen, Germany, 37075, Göttingen, Germany.

⁶Auditory Neuroscience and Optogenetics Group, German Primate Center, 37077 Göttingen, Germany.

⁷Functional Auditory Genomics Group, Auditory Neuroscience and Optogenetics Laboratory, German Primate Center, Göttingen, Germany.

According to the World Health Organization an increasing number of 0.5 billion people, worldwide, are currently suffering from disabling hearing loss (HL). HL is mostly caused by dysfunction or loss of cochlear hair cells leading to sensorineural hearing loss. Since the 1970s direct electrical stimulation of spiral ganglion neurons (SGNs) bypasses the dysfunctional sensory organ. Thus, electrical cochlear implants (eCI) provide open speech perception and hearing restoration. As wide-spread electrical current recruits large populations of SGNs, auditory perception is limited in context of frequency resolution of sound encoding. Hence, eCI users experience unnatural auditory perception, limited music appreciation and difficulties in speech comprehension in noisy backgrounds. As light can be better confined in space, optogenetic stimulation of SGNs promises an alternative to overcome this bottleneck. Utilizing light-gated ion channels, so-called Channelrhodopsins (ChRs), mammalian neurons can be driven optically. To maintain the temporal characteristics of physiological sound encoding in the cochlea, it is critical to select ChRs with fast kinetics, large photocurrents, and low desensitization.

Here, we evaluate the optogenetic utility of ChR-variants recently engineered for optogenetic stimulation of SGNs (ChR2- and Chronos-mutants), in mice. Transduction of SGNs was achieved by local administration of non-pathogenic, adeno-associated viruses (AAVs) into the round window of the cochlea (rw) of neonatal mice (postnatal day 6). AAVs enabled transgenic ChR-expression under the human synapsin promotor with sequences aimed to enhance membrane targeting – enhancement of trafficking signal (TS) and ER export signal (ES). Six to thirteen weeks after injections, a laser-coupled fiber (473nm) was inserted into the rw to probe for optically evoked auditory brainstem responses (oABRs). Subsequently, the cochleae were extracted for immunohistological analysis by confocal and lightsheet microscopy to evaluate the number of transduced cells as well as membrane expression profiles with or without enhancement.

Electrophysiological data sets of 24 animals, injected with four different ChR-variants, show optical activation in three out of four sets. Furthermore, differences regarding waveform, amplitudes, thresholds, latencies and repetition rates were observed. The temporarily conclusion of combined electrophysiology and histology highlights a lead candidate out of our four ChR-variants for the optogenetic activation of the

auditory pathway with blue light for auditory research and future optogenetic cochlear implants.

Molecular alterations underlying hypotonia in SHANK3 deficiency

Berra Yildiz, Dr. Anne-Kathrin Lutz¹, Prof. Dr. Tobias Böckers¹

¹Universität Ulm, Institut für Anatomie und Zellbiologie, Albert-Einstein-Allee 11, 89069 Ulm, Germany

Phelan-McDermid syndrome (PMDS) is a syndromic form of Autism Spectrum Disorders (ASD) classified as a rare genetic developmental disease featuring global developmental delay, absent or delayed speech, ASD-like-behaviour and neonatal skeletal muscle hypotonia. PMDS is induced by a chromosome 22q13.3 variation, that affects the *SHANK3* gene. Since SHANK3 is known to play a significant role in muscle formation and differentiation, we aimed to study pathways underlying muscular hypotonia by analyzing transcriptional alterations by RNA-sequencing in muscle of neonatal *Shank3* mice. We found that genes involved in calcium ion regulation, PTK6 signaling pathway, and voltage-gated ion channels activity were affected by Shank3 loss. In *Shank3* mice muscle, immunostaining and Western blot revealed enhanced expression of the calcium binding protein Calsequestrin (CSQ), voltage gated potassium channel (KCNK18), voltage-gated calcium channel (CACNA1D), and phospho-tyrosine-kinase 6 (PTK6), in accordance with RNA-sequencing data. Using the calcium chelator BAPTA we determined the calcium concentration in the whole skeletal muscle sample and found that calcium levels were increased in neonatal SHANK3 KO mice muscles. Our results emphasize the reciprocal effects of SHANK3 and calcium, and concentrates on alterations that lead to muscle hypotonia. These data prove that our SHANK3 mice have a calcium storage and secretion problem and that they have abnormalities in the expression of proteins involved in neuromuscular transmission. Our results emphasize the reciprocal effects of SHANK3 and calcium, and concentrates on alterations that lead to muscle hypotonia.

Binge eating suppresses flavor representations in the mouse olfactory cortex

Hung Lo, Anke Schoenherr¹, Malinda L.S. Tantirigama^{3,5}, Laura Moreno Velasquez¹, Lukas Faiss^{1,6}, Benjamin Rost^{1,6}, Matthew Larkum³, Benjamin Judkewitz^{1,2,5}, Katharina Stumpfenhorst⁴, Marion Rivalan⁵, York Winter⁴, Dietmar Schmitz^{1,2,5,6}, Friedrich Johenning^{1,2}

¹Charité – Universitätsmedizin Berlin, corporate member of Freie Universität Berlin and Humboldt-Universität zu Berlin, Neuroscience Research Center, Berlin, Germany

²Charité – Universitätsmedizin Berlin, corporate member of Freie Universität Berlin and Humboldt-Universität zu Berlin, Einstein Center for Neurosciences Berlin, Berlin, Germany

³Institut für Biologie, Humboldt Universität zu Berlin, Berlin, Germany

⁴Cognitive Neurobiology, Humboldt Universität zu Berlin, Berlin, Germany

⁵Charité – Universitätsmedizin Berlin, corporate member of Freie Universität Berlin and Humboldt-Universität zu Berlin, NeuroCure Cluster of Excellence, Berlin, Germany

⁶Center for Neurodegenerative Diseases (DZNE), Berlin, Germany

Appropriate feeding behavior is the foundation of maintaining homeostasis. Elevated feeding rate (binge eating) is a common trait of eating disorders, and it is associated with obesity. It is also known that flavor perception has an active role in regulating feeding. However, the effects of feeding rate on flavor sensory feedback remain unknown. We developed a liquid food delivery system that mice can consume flavored milk with different feeding rates, e.g., slow eating mode (4-second interval) and binge eating mode (0.4-second interval). Using miniscope in mice, we showed that binge eating suppresses neuronal activity in the anterior olfactory (piriform) cortex (aPC), while slow eating does not. The strength of binge-induced suppression in the aPC predicts animals' consumption and duration of feeding. This binge-induced suppression is only observed in aPC, not in gustatory or somatosensory cortices.

Odor inputs from olfactory bulb mitral cells remain stable upon binge eating, suggesting the suppression is not due to degraded odor inputs. The suppression is also unlikely due to the activation of local GABAergic aPC interneurons (PV⁺ & SST⁺). We further examined the inhibitory effects of dopaminergic and serotonergic modulation in the aPC by using in vivo neuromodulator imaging. Taken together, our results provide clear circuit mechanisms of binge-induced flavor modulation, which may contribute to binge-induced overeating due to reduced sensory feedback of food items.

Binge eating suppresses flavor representations in the mouse olfactory cortex (piriform cortex)

Lo et al., 2022

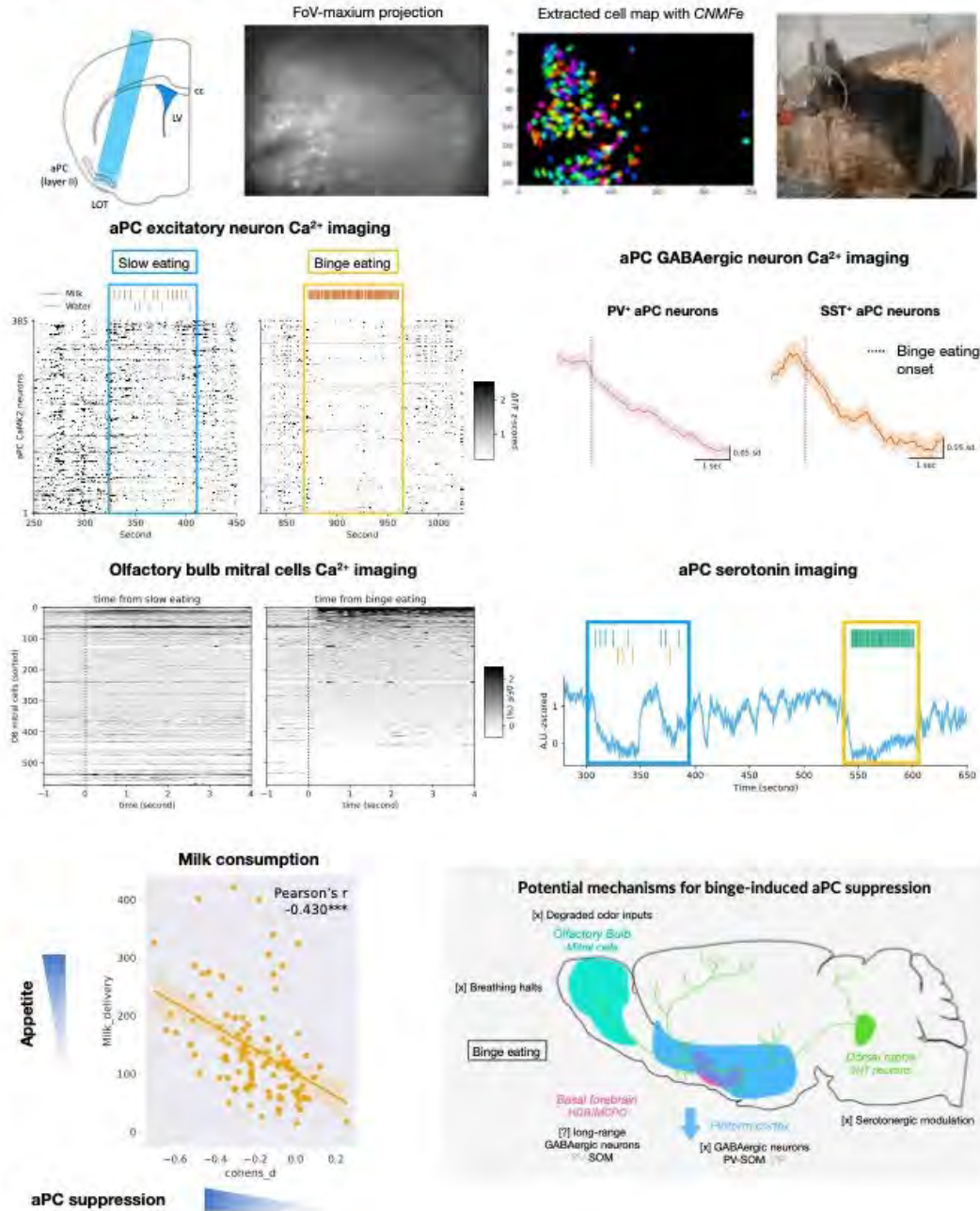

Circadian regulation of trigeminal pain circuits

Florian Zirpel, Zameel Cader¹

¹University of Oxford, Nuffield Department of Clinical Neurosciences, South Parks Road, New Biochemistry Building, OX1 3QU Oxford, United Kingdom

Circadian characteristics of pain have been described in humans and animal models, but the underlying mechanisms remain unclear. Preliminary data from our group suggest that trigeminal nociceptor activity and orofacial pain behaviour vary depending on the time of day.

Patch clamp recordings from acute trigeminal nucleus caudalis (TNC) slices revealed differences in excitatory drive between two time points assessed, with increased spontaneous input to layer I/II TNC neurons at the time point corresponding to decreased pain behaviour. At this time point, activation of primary nociceptors using the TRPV1 agonist capsaicin did not affect the frequency of excitatory postsynaptic currents (EPSCs) in the presence of the GABA_A blocker picrotoxin. Surprisingly, in absence of synaptic blockers, a third of neurons at this time point showed reduced EPSC rates when capsaicin was applied. Furthermore, sIPSC rate was modulated by capsaicin depending on the time of day. Global knockout of the clock genes *Cry1* and *Cry2*, and sensory neuron-specific ablation of *Bmal1* abolished the variation of synaptic currents between time points. Collectively, the data supports the role of circadian mechanisms in intraspinal modulation of trigeminal nociceptive traffic.

Regulation of social behaviour and anxiety by cortical inputs to lateral hypothalamus

Alisa Bakhareva, Anne Petzold¹, Tatiana Korotkova¹

¹Institute for Vegetative Physiology, University of Cologne, AG Korotkova, Robert-Koch-Str. 39, 50931 Cologne, Germany

Background: Stress is an adaptive mechanism that enables an optimal response to danger. However, chronic stress disrupts normal bodily functions, and can lead to various physical and mental disorders. The medial part of the prefrontal cortex (mPFC) is involved in the regulation of stress responses. Its activation mitigates negative effects of stress and engages coping. One of the output targets of the mPFC is the lateral hypothalamus (LH), a brain region that regulates innate behaviours known to be affected by stress. In this work, we studied whether and how downstream projections of mPFC to LH shape innate behaviours in stressful situations.

Methods: We expressed an opsin eNPAC2.0 in mPFC and analysed effects of optogenetic stimulation of inputs from mPFC to LH on innate behaviours in freely behaving mice. The behavioural enclosure contained food, water, a conspecific and, in a subset of experiments, a shelter. In a subset of experiments we exposed mice to mild metabolic (acute and chronic food restriction) or non-metabolic (acute restraint) stress.

Results: Optogenetic stimulation of mPFC projections to the LH in unstressed mice promoted social interactions at the expense of feeding behaviour. However, following acute food restriction (metabolic stress), the stimulation had opposite effects, changing the balance between consumption and social interactions in favour of consumption. This effect was not detected following prolonged food restriction. Following acute restraint the mPFC to LH stimulation reduced the time that mice hid in a shelter. When mPFC projections to the LH were stimulated during the stressful experience of acute restraint prior to the behavioural test, we also observed reduced time in the shelter, as well as increased sociability.

Conclusions: The activation of mPFC inputs to LH promoted behaviours that alleviated stress such as food seeking following fasting, or seeking out conspecifics following restraint. An increase in sociability in response to stress could reflect social buffering, an active coping behaviour engaged to overcome distress. Thus, mPFC input to LH can promote adaptation in response to stress.

Limiting factors and regulatory consequences of cFos expression

Andreas Franzelin, Paul Lamothe-Molina¹, Margarita Anisimova¹, Chris E. Gee¹, Thomas G. Oertner¹

¹ZMNH (UKE), Institute of Synaptic Plasticity, Falkenried 94, 20251 Hamburg, Germany

cFos labeling has been used to identify active neurons to define the physiological substrate of a particular memory. cFos is relevant for memory and synaptic plasticity, but which signaling pathways are essential to induce cFos and what are the consequences for subsequent cFos expression? We investigated the function of dentate gyrus neurons expressing cFos in the Morris Water Maze (WM). We found that optogenetic inhibition of these neurons during probe trails on subsequent days significantly decreased the animal's performance. Furthermore, CaMPARI expressed in cFos-tagged neurons became photoconverted during probe trails on subsequent days, indicating that these cells experienced large calcium transients. Despite clear signs of reactivation and their importance for memory recall, cFos-tagged DG neurons did not express cFos again in the following days. This cell-specific cFos inhibition was not observed in area CA1 and could be reproduced in organotypic hippocampal slice culture. Pretreatment of slice cultures with bicuculline significantly decreased cFos expression in DG after a second treatment 24 h later. The effect of the pretreatment could be reversed by interfering with Δ FosB phosphorylation or by inhibiting HDACs. Using stimulation protocols of different duration, we found that cFos and intracellular calcium levels correlate on the population level, but not on the single-cell level. Optogenetic inhibition of single neurons during bicuculline-induced activity decreased cFos expression, indicating that glutamatergic input AND postsynaptic spiking is required to drive cFos expression in this paradigm. In summary, our findings show that neurons do not respond with the same cFos intensity to each activation event. Rather, the cFos response is neuronal subtype dependent and strongly influenced by the history of activity. Previous studies have shown that after epileptic events, Δ FosB accumulates in the hippocampus and interferes with cFos expression. We suggest that the physiological role of Δ FosB is to drive pattern separation in the dentate gyrus by modulating the epigenetic state of individual neurons.

An electrosensory cocktail party problem

Alexandra Barayeu, Maria Schlungbaum^{2,3}, Benjamin Lindner^{2,3}, Jan Grewe^{1,2}, Jan Benda^{1,2}

¹Eberhard Karls University, Tübingen , Neuroethology, Institut for Neurobiology, Auf der Morgenstelle 28, 72076 Tübingen, Germany

²Institut for physics, Humboldt-University, Berlin

³Bernstein Center for Computational Neuroscience, Berlin

⁴Bernstein Center for Computational Neuroscience, Tübingen

The “cocktail party problem” is about segregating an auditory stream from background sounds. We studied an electrosensory cocktail party problem in weakly electric fish of the species *Apteronotus leptorhynchus*. These fish generate a surrounding electric field by electric organ discharges (EOD) with a stable frequency. When two fish meet their EODs interfere and generate a beating amplitude modulation (AM) with a frequency given by the difference between the two EOD frequencies. When three fish interact a so called social envelope emerges, with its frequency given by the difference between the two beat frequencies. We studied a situation of three fish, based on observations of resident males that courted females (strong signals) and that simultaneously were able to detect and attack intruding males over large distances (faint signal). How is this faint beat on top of the strong beat encoded and detected by the electrosensory system?

We approached this question with electrophysiological recordings and simulations of realistic leaky integrate-and-fire models of primary sensory afferents, the P-units, that encode AMs in their firing rates. We found enhanced detectability of the intruder signal electrophysiologically and in models of P-units. Some of the models revealed nonlinear effects where the interaction of two stimulus frequencies resulted in enhanced responses at the baseline frequency of the cell, not at the stimulus frequencies. Still, in the electrophysiologically measured P-unit population we found such nonlinear effects only in a small subpopulation characterized by low intrinsic noise in their spiking dynamics. These low-noise cells might be the basis for an improved detectability of the intruder. On the other hand, response enhancement through non-linear interaction leads to response power at other frequencies, the nonlinear effect might be in fact detrimental. In this line of thinking, the noisiness of the majority of the measured P-units would be an adaptive mechanism to suppress undesired nonlinear effects and to keep the response as linear as possible. This would mean that there is actually no cocktail party problem, the two stimulus frequencies are transmitted independently of each other. We discuss these competing hypotheses in context of natural stimulus frequencies and amplitudes as well as P-unit coding properties.

A septal-VTA circuit drives exploratory behavior

Petra Mocellin, Kevin Luxem¹, Oliver Barnstedt¹, Hiroshi Kaneko¹, Dennis Daluegge^{1,2},
Falko Fuhrmann¹, Sanja Mikulovic³, Stefan Remy¹

¹Leibniz Institute for Neurobiology (LIN), Cellular Neuroscience, 39118 Magdeburg, Germany

²International Max Planck Research School for Brain and Behavior (IMPRS), 53175 Bonn, Germany

³Leibniz Institute for Neurobiology (LIN), Cognition and Emotion, 39118 Magdeburg, Germany

To survive, animals need to balance their exploratory drive with their need for safety. Subcortical circuits play an important role in initiating and modulating movement based on external demands and the internal state of the animal; but how motivation and onset of locomotion are regulated remains largely unresolved. Here, we show that a glutamatergic pathway from the medial septum and diagonal band of Broca (MSDB) to the ventral tegmental area (VTA) controls exploratory locomotor behavior in mice. Using a self-supervised machine learning approach, we found an overrepresentation of exploratory actions, such as sniffing, whisking, and rearing when this projection is optogenetically activated. Mechanistically, this role relies on glutamatergic MSDB projections that monosynaptically target a subset of both glutamatergic and dopaminergic VTA neurons. Taken together, we identified a novel glutamatergic basal forebrain to midbrain circuit that initiates locomotor activity and contributes to the expression of exploration-associated behavior.

Symposium

S14: Plasticity in unexpected places: flexible circuits for instinctive behaviours

[S14-1](#) Cortical Plasticity of Innate behavior
Adi Mizrahi

[S14-2](#) A dedicated hypothalamic oxytocin circuit controls social avoidance learning
Takuya Osakada, Dayu Lin

[S14-3](#) Distinct lateral hypothalamic cell populations resist hunger pressure to balance nutritional and social needs
Rebecca Figge-Schlensock, Anne Petzold, Hanna van den Munkhof, Tatiana Korotkova

S14-4 Retracted

[S14-5](#) Midbrain circuits for flexible instinctive behaviours
Vanessa Stempel

Cortical Plasticity of Innate behavior

Adi Mizrahi¹

¹Hebrew University of Jerusalem, Edmond and Lily Safra center for Brain Sciences, 1204 Goodman Bldg, ELSC, Safra Campus,, 91904 Jerusalem, Israel

We study parental behavior, which is considered an innate behavior. Superficially, we are interested in the experience-dependent component of parenthood and how it interacts with the its innate substrate. We focus on the plasticity of cortical representation of communication calls among parents and offspring, which are used by the animals to promote care. I will discuss our imaging, tracing and electrophysiological work and show the plastic nature of sound representation in the auditory cortex of mothers fathers and others, following parent-infant bonding.

A dedicated hypothalamic oxytocin circuit controls social avoidance learning

Takuya Osakada¹, Dayu Lin¹

¹New York University Langone Medical Center, Neuroscience Institute, 435 East 30th Street, Science Building, 1323S, 10016 New York, USA

Many animals live in complex social groups. To survive, it is essential to know who to avoid and who to interact. Although naïve mice are naturally attracted to any adult conspecifics, a single defeat experience could elicit social avoidance towards the aggressor for days. The neural mechanisms underlying the behavior switch from social approach to social avoidance remains incompletely understood. Here, we identify oxytocin neurons in the retrochiasmatic supraoptic nucleus (SOR^{OXT}) and oxytocin receptor (OXTR) expressing cells in the anterior subdivision of ventromedial hypothalamus, ventrolateral part ($aVMHvl^{OXTR}$) as a key circuit motif for defeat-induced social avoidance learning. After defeat, $aVMHvl^{OXTR}$ cells drastically increase their responses to aggressor cues. This response change is functionally important as optogenetic activation of $aVMHvl^{OXTR}$ cells elicits time-locked social avoidance towards a benign social target whereas inactivating the cells suppresses defeat-induced social avoidance. Furthermore, OXTR in the $aVMHvl$ is itself essential for the behavior change. Knocking out OXTR in the $aVMHvl$ or antagonizing the receptor during defeat, but not during post-defeat social interaction, impairs defeat-induced social avoidance. $aVMHvl^{OXTR}$ receives its private supply of oxytocin from SOR^{OXT} cells. SOR^{OXT} is highly activated by the noxious somatosensory inputs associated with defeat. Oxytocin released from SOR^{OXT} depolarizes $aVMHvl^{OXTR}$ cells and facilitates their synaptic potentiation, and hence, increases $aVMHvl^{OXTR}$ cell responses to aggressor cues. Ablating SOR^{OXT} cells impairs defeat-induced social avoidance learning whereas activating the cells promotes social avoidance after a subthreshold defeat experience. Altogether, our study reveals an essential role of SOR^{OXT} - $aVMHvl^{OXTR}$ circuit in defeat-induced social learning and highlights the importance of hypothalamic oxytocin system in social ranking and its plasticity.

Distinct lateral hypothalamic cell populations resist hunger pressure to balance nutritional and social needs

Rebecca Figge-Schlensook, Anne Petzold^{1,2}, Hanna van den Munkhof^{1,2}, Tatiana Korotkova^{1,2}

¹Institute for Vegetative Physiology, University of Cologne, Cologne, Germany

²Neuronal Circuits Analysis, Max Planck Institute for Metabolism Research, Cologne, Germany

The lateral hypothalamus (LH) plays a major role in regulating consummatory behaviors to maintain homeostasis. However, hunger and thirst are continuously weighed against competing needs, according to state and opportunity. The neuronal mechanisms of representation and prioritization of multiple innate rewards remain poorly understood.

We investigated how distinct neuronal populations, such as leptin receptor-expressing neurons (LepR), in the LH guide increasingly hungry animals through behavioral choices. For that purpose we used opto- and chemogenetic stimulation as well as single cell, deep-brain calcium imaging in freely moving mice in various nutritional states. Stimulation of LepR neurons promoted interaction with females but not males despite moderate hunger pressure. Furthermore, LepR neurons exhibited stronger responses to females than to males during spontaneous social interaction. Hunger pressure led to increase of food-selective and decrease of social-selective LepR neurons, suggesting need-dependent competitive coding of these orthogonal stimuli by LepR neurons. In contrast, activation of the complementary cell population of neurotensin-expressing cells (Nts) reduced social interaction, and activity of Nts neurons did not differentiate the sex of conspecifics.

Here, we demonstrate the distinct role of LepR neuron activity in promoting social interaction despite hunger pressure. Thereby this population exerts opposite effects as compared to Nts neurons, which restrain social drive. This complementary control of innate drives enables flexible fulfillment of orthogonal needs according to current opportunities and gated by physiological demands.

We gratefully acknowledge support by the ERC Consolidator Grant (772994, FeedHypNet, to T.K.) and the DFG (233886668-GRK1960, to R.F., Project-ID 431549029 – SFB 1451, to T.K., EXC2030 CECAD, to T.K.).

Midbrain circuits for flexible instinctive behaviours

Vanessa Stempel¹

¹Max Planck Institute for Brain Research, Instinctive Behaviour Circuits Group, Max-von-Laue-Str. 4, 60438 Frankfurt am Main, Germany

Instinctive behaviours, such as mating, hunting and defence have evolved to ensure survival without the need for learning. In vertebrates, instinctive behaviours are generated by remarkably conserved brain circuits, and it has become increasingly clear in recent years that instinctive behaviours are flexible in regard to both action selection and execution. Despite a large body of behavioural work, the neural mechanisms underlying the flexible implementation of instinctive behaviours remain largely unknown. In this talk, I will discuss how excitatory and inhibitory neural circuits in the midbrain periaqueductal gray dynamically control the initiation and execution of multiple instinctive behaviours.

Symposium

S15: Breaking News

- [S15-1](#) DKK1 – an ambivalent regulator of cellular homeostasis in enteric nervous system signalling
Melanie Scharr, Melina Fischer, Simon Scherer, Peter Neckel
- [S15-2](#) Chemogenetic activation of the locus coeruleus increases noradrenaline levels in the hippocampus and modulates its hippocampal excitability
Sielke Caestecker, Robrecht Raedt, Paul Boon, Kristl Vonck, Lars Emil Larsen
- [S15-3](#) Investigating ultrastructural and molecular correlates of short-term facilitation at hippocampal mossy fibre synapses
Inés Hojas García-Plaza, Francisco José López-Murcia, Manuela Schwark, Holger Taschenberger, Nils Brose, Cordelia Imig, Benjamin H. Cooper
- [S15-4](#) Characterization of tanycytes in an Alzheimer's disease mouse model
Nina Feller, Surya Prakash Rai, Markus Schwaninger
- [S15-5](#) Molecular characterization of the sequential processes underlying synaptic degeneration
Zeeshan Mushtaq, Raiko Stephan, Dario Lasser, Lena Lion, Benjamin Escribano, Jan Pielage
- [S15-6](#) De novo immunoreactivity against central nervous system antigens after human spinal cord injury
Carmen Haider, Jan M. Schwab, Marcel A. Kopp, Tobias Zrzavy, Verena Endmayr, Gerda Ricken, Helmut Kubista, Thomas Haider, Thomas Liebscher, Tom Lübstorf, Christian Alex, Leonarda Serdani, Armin Curt, Paolo Cinelli, Giorgio Scivoletto, Michael G. Fehlings, Caroline May, Annika Guntermann, Katrin Marcus, Christian Meisel, Ulrich Dirnagl, Peter Martus, Harald Prüss, Phillip G. Popovich, Hans Lassmann, Romana Höftberger*
- [S15-7](#) Motoneuronal inflammasome activation triggers neuroinflammation and impedes regeneration following sciatic nerve injury
Bernát Nógrádi, Kinga Molnár, Rebeka Kristóf, Ádám Mészáros, Krisztián Pajer, László Siklós, Antal Nógrádi, Imola Wilhelm, István A. Krizbai
- [S15-8](#) Evaluation of neurophysiological effects of psilocybin in chronic alcoholism using epicortical neuroprosthetics
Bettina Habelt, Dzmitry Afanasenkau, Ivan R. Minev, Rainer Spanagel, Marcus Meinhardt, Nadine Bernhardt
- [S15-9](#) Hopper by name, hopper by nature. Decision-making processes underlying the locust startle

response.

Yannick Günzel, Hannes Kübler, Einat Couzin-Fuchs

[S15-10](#) Rho-kinase involvement in subretinal fibrosis

Yuebing Li, Souska Zandi, Laura Jahnke, Volker Enzmann

DKK1 – an ambivalent regulator of cellular homeostasis in enteric nervous system signalling

Melanie Scharr, Melina Fischer¹, Simon Scherer², Peter Neckel¹

¹Institute of Clinical Anatomy and Cell Analysis, University of Tübingen, Tübingen, Germany

²Department of Paediatric Surgery, University Children's Hospital, Tübingen, Germany

Neural progenitor cells from the enteric nervous system (ENS) are a potential source for cell-replacement therapies. Yet, the regulation of this ENS-progenitor cell pool remains poorly characterized, especially its high proliferative capacity *in vitro* despite its quiescent state *in vivo*. Our previous studies indicate an extensive involvement of the Wnt/ β -catenin-signaling cascade in proliferation and differentiation of postnatal ENS-progenitor cells. The secreted Wnt-antagonist Dickkopf-1 (DKK1) is involved in a series of cellular/context-dependent functions including regulating cell proliferation and differentiation, cell survival and programmed cell death. Here, we hypothesize that the Wnt regulator DKK1 drives enteric neuronal differentiation by inhibiting proliferation, extending the functions of the Wnt-regulatory-network in the postnatal gut of mice and human.

For this purpose, we isolated enteric progenitor cells from the muscular layer of the intestine of new-born wildtype and transgenic mice as well as from paediatric gut samples. *In situ* hybridization as well as immunohistochemical experiments showed that DKK-ligands and corresponding receptors are expressed within submucosal and myenteric ganglia of the murine and human intestine. Moreover, molecular biological evaluation revealed that postnatal ENS-progenitors are equipped with receptors and signaling cascade components essential for pharmacological probing. But, surprisingly, on a cellular level, DKK1-stimulation led to a significant and profound increase in the proliferation of the P75⁺ neural cell population and in the size of murine spheroids in *ex vivo* cultures, forcing us to reject our initial hypothesis. Astonishingly, however, the pro-proliferative effect of DKK1 on P75⁺ neural cell population did not lead to an increase in the yield of newly-generated enteric neurons and glial cells. An effect, we were able to reproduce in human ENS-progenitor cells as well, thereby adding clinical relevance to our findings and indicating that this mechanism is conserved across different mammal species.

Moreover, several studies have shown, that DKK1 is involved in cell-cycle control mediating apoptotic-mechanisms arguably by Caspase-3 activity. To further address the role of DKK1-mediated apoptosis, TUNEL and live-monitoring-Caspase-3/7 activity assays showed, that the profound increase in ENS-progenitor cell proliferation was paralleled by an increased cell-death in the P75⁺ neural cell population by a Caspase-3/7-dependent mechanism. Yet, once we blocked apoptosis by applying a pan-Caspase inhibitor, DKK1 stimulation markedly increased enteric neurogenesis and gliogenesis in ENS-progenitors. This indicates that the cell-death-induction by DKK1 can be rescued without interrupting the pro-proliferative effect of this Wnt-antagonist.

In conclusion, DKK1 is a strong, ambivalent regulator of the ENS-progenitor cell pool in mice and humans during postnatal maturation. These results are fundamental steps reshaping our understanding of the homeostasis of the ENS in health and disease. Additionally, since enteric neuropathies may be associated with hyperganglionosis, the developmental importance of DKK1 for orchestrating an appropriate amount of

proliferating enteric progenitor cells should be further investigated.

Chemogenetic activation of the locus coeruleus increases noradrenaline levels in the hippocampus and modulates its hippocampal excitability

Sielke Caestecker, Robrecht Raedt¹, Paul Boon¹, Kristl Vonck¹, Lars Emil Larsen^{1,2}

¹4BRAIN, Department of Head and Skin, Ghent University, Belgium

²Medical Imaging and Signal Processing, Ghent University, Belgium

Purpose: The brainstem locus coeruleus (LC) is the sole source of noradrenaline in the neocortex, hippocampus and cerebellum. Noradrenaline is an endogenous neuromodulator involved in the regulation of excitability and plasticity of large-scale brain networks. Previous pharmacological studies have indicated that noradrenaline is able to potentiate dentate gyrus excitability and increases the population spike of perforant-path evoked potentials. These studies hold several limitations, since pharmacological interventions are likely to induce unintended off target effects. Recent development of tools for precision modulation of the LC, including Designer Receptors Exclusively Activated by Designer Drugs (DREADDs) allow the study of LC physiology with unprecedented detail. In this study, we assessed the influence of chemogenetically activating the LC on noradrenergic signaling and excitability in the hippocampus.

Methods: Male Sprague Dawley rats (n=5) were stereotactically injected with the viral vectors CAV2-PRs8-hM3Dq-HA hSyn-mCherry in the LC and AAV9-hSyn-NE2m-mRuby3 in the hippocampus to induce expression of hM3Dq in noradrenergic LC neurons and the GRAB_{NE2m} noradrenaline biosensor in hippocampal neurons. Two weeks after vector injection rats were anesthetized and implanted with a stimulation electrode in the perforant path (PP) and a recording optrode in the dentate gyrus. Rats were injected with deschloroclozapine (DCZ, 0.1 mg/kg, s.c) to chemogenetically activate the LC and the effects on noradrenaline signaling and dentate gyrus electrophysiology were assessed by comparing GRAB_{NE2m} fluorescence, EEG and evoked potentials before and after DCZ injection.

Results: Injection of DCZ resulted in a pronounced increase in GRAB_{NE2m} fluorescence (z-score range: 5 - 15), a decrease in EEG power and an increase in the amplitude of the population spike of the dentate gyrus evoked potential (a marker for postsynaptic activation of DG neurons). No significant change in the slope of the evoked potential (a marker of synaptic strength) was found. In individual animals, changes in the population spike amplitude and EEG power were significantly correlated to the observed changes in GRAB_{NE2m} fluorescence (**Figure**).

Conclusions: This study is the first to assess the effect of chemogenetic activation of the LC on noradrenaline signaling in the hippocampus with GRAB-sensor technology, providing unprecedented temporal resolution. By means of cell-type specific modulation of LC neurons, we were able to confirm previous findings of pharmacological studies with superior precision and specificity.

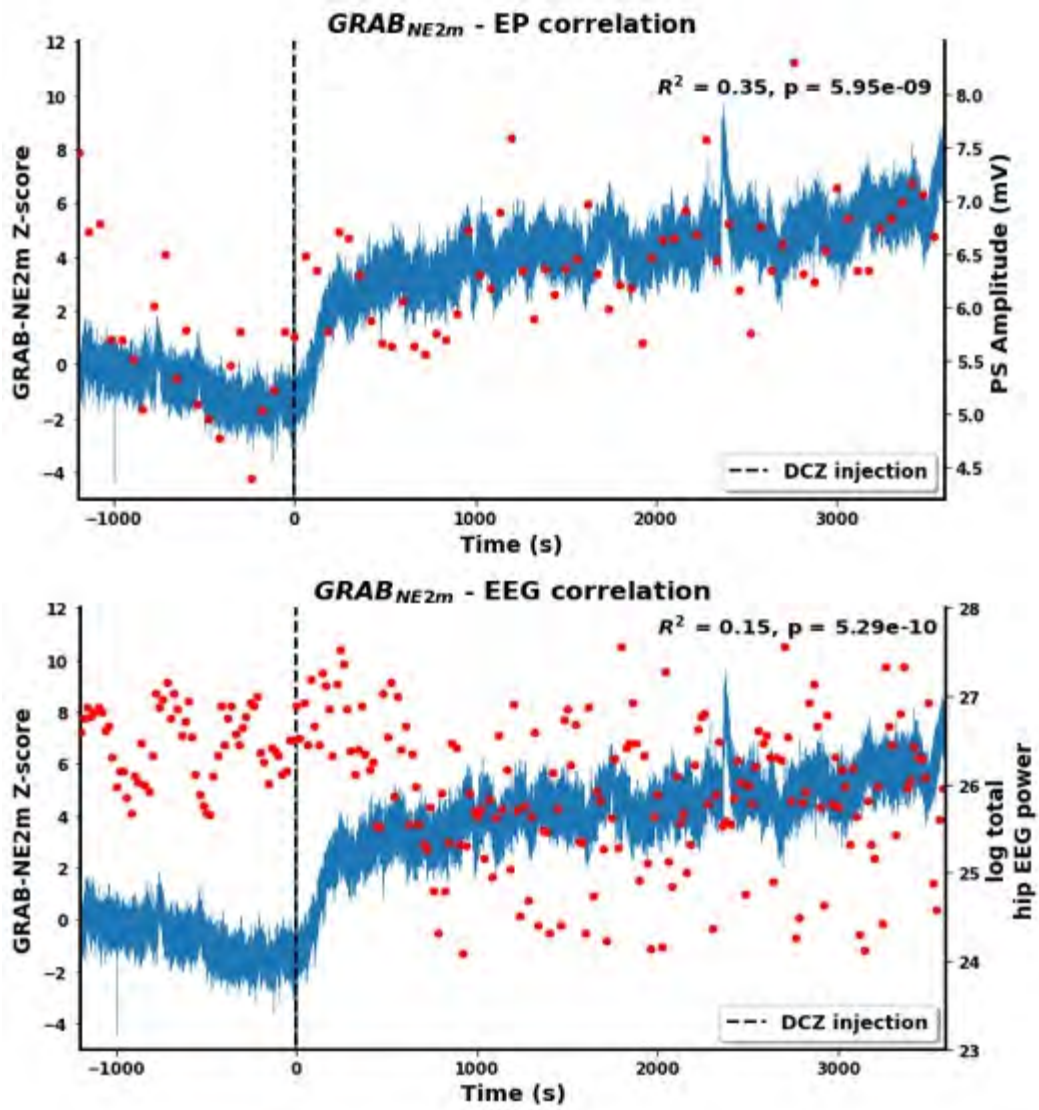

Figure: Example from one animal, of the correlation between the changes in GRAB_{NE2m} fluorescence and the changes in population spike (PS) amplitude of the perforant-path evoked potential (EP) and hippocampal (hip) EEG power.

Investigating ultrastructural and molecular correlates of short-term facilitation at hippocampal mossy fibre synapses

Inés Hojas García-Plaza, Francisco José López-Murcia^{1,2}, Manuela Schwark¹, Holger Taschenberger¹, Nils Brose¹, Cordelia Imig^{1,3}, Benjamin H. Cooper¹

¹Max Planck Institute for Multidisciplinary Sciences, Department of Molecular Neurobiology, City Campus, Hermann-Rein-Straße 3, 37075 Göttingen, Germany

²Laboratory of Neurobiology, Department of Pathology and Experimental Therapeutics, University of Barcelona, L'Hospitalet de Llobregat, Barcelona 08907, Spain

³Department of Neuroscience, University of Copenhagen, 2200 Copenhagen, Denmark

Neurons communicate with each other at synaptic contact sites, where a pool of docked neurotransmitter-filled synaptic vesicles (SVs) fuse in response to an action potential at specialized presynaptic active zones (AZ). Our work focuses on the hippocampal mossy fibre (MF) synapse, formed between dentate gyrus granule cells and CA3 pyramidal cells. The complexity of this synapse manifests in its large presynaptic bouton's size, which contains many individual AZs, a very low initial release probability, and a particularly pronounced short-term facilitation (STF)¹, with several mechanisms postulated to contribute to MF STF in recent years². However, ultrastructural information linking these activity-dependent processes to spatially defined SV subpopulations is required to fully interpret short-term plasticity processes. Light stimulation-coupled high-pressure freezing ("flash-and-freeze") combined with electron microscopy (EM) are powerful methods for probing ultrastructure-function relationships at synapses by revealing the structural organization of synapses at subcellular resolution, both at rest and during defined activity states^{3,4}.

Our previous studies using these methodologies showed that hippocampal MF synapses harbour two distinct morphological vesicle pools in the proximity of AZs at rest (docked and tethered SVs⁵) and that long, high-frequency stimulation protocols designed to induce steady-state depression caused a partial depletion of docked SVs³. How these two SV pools are recruited during different activity patterns and how they contribute to shaping MF STF is currently not understood. The goal of the present study is to analyse the dynamic organisation and remodelling of AZ-proximal SV pools during STF at the hippocampal MF synapse in intact circuits using shorter stimulation trains, and to dissect the underlying molecular mechanisms. Our experimental approach includes a deletion mutant of the Ca²⁺ sensor Synaptotagmin-7, recently identified as a major contributor to MF STF⁶, to isolate aspects of activity-dependent SV pool remodelling most relevant to the facilitated functional state.

¹ Nicoll & Schmitz (2005) *Nat Rev Neurosci* 6, 863. ² Jackman & Regehr (2017) *Neuron* 94, 447. ³ Imig, C. et al. (2020) *Neuron* 108, 843. ⁴ Watanabe, S. et al. (2013) *Nature* 504, 242. ⁵ Maus, L. et al. (2020) *Cell Rep* 30, 3632. ⁶ Jackman, S. L. et al. (2016) *Nature* 529, 88.

Characterization of tanycytes in an Alzheimer's disease mouse model

Nina Feller, Surya Prakash Rai¹, Markus Schwaninger¹

¹University of Luebeck, Institute of Experimental and Clinical Pharmacology and Toxicology, Ratzeburger Allee 160, 23562 Luebeck, Germany

Alzheimer's disease (AD) is the most common form of dementia affecting over 50 million people worldwide. The accumulation of amyloid-beta in the brain, a cleaved peptide derived from the amyloid precursor protein, and the microtubule-associated protein tau is leading to synaptic dysfunction and neurodegeneration in AD patients. In addition, AD patients show non-cognitive deficits, such as weight loss, sleep-wake problems, and neuroendocrine alterations, which are due to hypothalamic dysfunction.

Located in the hypothalamus, tanycytes are highly specialized bipolar ependymal cells that line the ventrolateral wall and floor of the third ventricle in the hypothalamus where they form a blood-cerebrospinal fluid barrier at the level of the median eminence. They play a pivotal role in regulating metabolic networks that control body weight and energy homeostasis. It is known that tanycytic physiology is altered with age, both in terms of structural complexity and gene expression that may alter their structural plasticity. However, the role of tanycytes in aging and neurodegeneration is largely unknown.

Here, the humanized AD mouse model 5xFAD was used to investigate tanycyte integrity and amyloid-beta plaque distribution in the hypothalamus. Experiments were performed on 1.5- to 14-month-old male and female heterozygous and non-transgenic littermates. To explore the integrity of the tanycytes, the immunohistochemical analysis of the vimentin-positive processes were analyzed.

In addition, barrier characteristics of tanycytes, such as the tight junction pattern, were investigated. Histological analysis showed no or few amyloid-beta plaques in the hypothalamus of 5xFAD mice in comparison to the thalamus or other brain regions, although the transgene was expressed to a similar level in the hypothalamus and thalamus. Our data suggest that the integrity of tanycytes contributes to low A β deposition in the hypothalamus.

Molecular characterization of the sequential processes underlying synaptic degeneration

Zeeshan Mushtaq, Raiko Stephan², Dario Lasser¹, Lena Lion¹, Benjamin Escribano¹, Jan Pielage¹

¹Technical university of Kaiserslautern, Zoology-Neurobiology, Erwin-Schrodinger strasse 13, 67665 Kaiserslautern, Germany

²Friedrich Miescher Institute for Biomedical Research, Basel, 4058, Switzerland.

Information processing in the nervous systems relies on the precise formation, maintenance, and plasticity of synapses. These functions depend on the regulated balance between synapse formation and elimination. Any mutations in genes essential for synaptic maintenance will therefore result in a loss of synaptic connectivity associated with progressive neurodegenerative disease. In recent years, significant progress has been made in our understanding of the molecular pathways controlling synapse stability and plasticity. Of particular importance is the microtubule cytoskeleton as a coordinator of axonal transport and synaptic organization. This is also underscored by the observation that mutations in microtubule-associated proteins can cause progressive neurodegenerative diseases. Despite these advances, the mechanisms that regulate microtubule dynamics to control synaptic maintenance remain unknown.

Here, we identify NudE, an auxiliary subunit of the Dynein-motor complex, as an essential regulator of axonal transport and synapse stability at the *Drosophila* neuromuscular junction (NMJ). Loss of NudE results in a progressive perturbation of the synaptic microtubule cytoskeleton and synaptic degeneration. We combined live-cell imaging and genetic interaction experiments with a correlative analysis of markers to identify the sequence of events that cause synapse disassembly. We demonstrate that a disruption of retrograde axonal transport initiation at synaptic terminals is sufficient to first perturb microtubule integrity and in turn cause synapse degeneration. We will present detailed insights into the molecular mechanisms that are essential to maintain and coordinate functional and structural synaptic stability.

De novo immunoreactivity against central nervous system antigens after human spinal cord injury

Carmen Haider, Jan M. Schwab^{*2,3,4}, Marcel A. Kopp⁴, Tobias Zrzavy⁵, Verena Endmayr¹, Gerda Ricken¹, Helmut Kubista⁶, Thomas Haider⁷, Thomas Liebscher^{4,8}, Tom Lübstorff⁴, Christian Alex⁴, Leonarda Serdani⁴, Armin Curt⁹, Paolo Cinelli¹⁰, Giorgio Scivoletto¹¹, Michael G. Fehlings¹², Caroline May¹³, Annika Guntermann¹³, Katrin Marcus¹³, Christian Meisel^{14,15}, Ulrich Dirnagl^{4,16}, Peter Martus¹⁷, Harald Prüss⁴, Phillip G. Popovich^{2,18}, Hans Lassmann¹⁹, Romana Höftberger¹

¹Medical University of Vienna, Division of Neuropathology and Neurochemistry, Waehringer Guertel 18-20, 1090 Vienna, Austria. ²The Belford Center for Spinal Cord Injury, The Ohio State University, Wexner Medical Center, 460 W. 12th Avenue, Columbus, OH 43210, USA. ³Departments of Neurology, Physical Medicine and Rehabilitation, and Neurosciences, The Ohio State University, 460 W. 12th Avenue, Columbus, OH 43210, USA. ⁴Department of Neurology and Experimental Neurology, Spinal Cord Injury Research (Neuroparaplegiology), Charité - Universitätsmedizin Berlin, corporate member of Freie Universität Berlin and Humboldt-Universität zu Berlin, Charitéplatz 1, D-10117 Berlin, Germany. ⁵Department of Neurology, Medical University of Vienna, Währinger Gürtel 18-20, A-1090 Vienna, Austria. ⁶Department of Neurophysiology and Neuropharmacology (Center for Physiology and Pharmacology), Medical University of Vienna, Währinger Gürtel 18-20, A-1090 Vienna, Austria. ⁷Department of Orthopaedics and Traumatology, Medical University of Vienna, Währinger Gürtel 18-20, A-1090 Vienna, Austria. ⁸Treatment Centre for Spinal Cord Injuries, BG Hospital Unfallkrankenhaus Berlin, Warener Str. 7, D-12683 Berlin, Germany. ⁹Spinal Cord Injury Center, Balgrist University Hospital, Forchstrasse 340, 8008 Zurich, Switzerland. ¹⁰Division of Trauma Surgery, University Hospital Zürich, Rämistr. 100, Zürich 8091, Switzerland. ¹¹IRCCS Fondazione S. Lucia, Spinal Cord Unit, via Ardeatina 306, Rome, Italy. ¹²Division of Neurosurgery and Spine Program, University of Toronto, 399 Bathurst St., Toronto, ON M5T 2S8, Canada. ¹³Ruhr-University Bochum, Center for Protein Diagnostics (PRODI), Medical Proteome Center, Universitätsstraße 150, D-44801 Bochum, Germany. ¹⁴Institute of Medical Immunology, Charité - Universitätsmedizin Berlin, corporate member of Freie Universität Berlin and Humboldt-Universität zu Berlin, Charitéplatz 1, D-10117 Berlin, Germany. ¹⁵Department of Immunology, Labor Berlin – Charité Vivantes GmbH, Sylter Strasse 2, 13353 Berlin, Germany. ¹⁶Berlin Institute of Health, QUEST-Center for Transforming Biomedical Research, Anna-Louisa-Karsch-Str. 2 10178 Berlin, Germany. ¹⁷Department of Clinical Epidemiology and Applied Biostatistics, Eberhard Karls Universität Tübingen, Silcherstraße 5, D-72076 Tübingen Germany. ¹⁸Department of Neurosciences, The Ohio State University, 460 W. 12th Avenue, Columbus, OH 43210, USA. ¹⁹Center for Brain Research, Medical University of Vienna, Währinger Gürtel 18-20, A-1090 Vienna, Austria.

Background and Objectives: Spinal cord injury (SCI) disrupts the balanced interaction between the CNS and immune system and can cause aberrant immune responses. The study examines emerging autoantibody synthesis after SCI with binding to conformational spinal cord epitopes and surface peptides located on the cell surface of dorsal root ganglia cells (DRGs).

Methods: Prospective longitudinal cohort study in acute care and in-patient rehabilitation centers in conjunction with a neuropathological case-control study in archival tissue samples ranging from acute (baseline) to several months after SCI (follow-up). In the cohort study, serum autoantibody binding was examined in a blinded manner using tissue-based assays (TBA) and primary DRG cultures. We compared traumatic motor complete SCI with motor incomplete SCI and isolated vertebral fracture without SCI. In the neuropathological section, B-cell infiltration and antibody secretion at the spinal lesion site was examined by

immunohistochemistry comparing SCI versus neuropathologically unaltered spinal cord tissue. Additionally, cerebrospinal fluid (CSF) in an individual patient was evaluated for dynamic changes in intrathecal antibody levels.

Results: Immunoreactivity of antibodies binding to both TBA and DRG assays was restricted to a SCI patient subpopulation only (16%, 9/55 sera) while being absent in vertebral fracture controls (0%, 0/19 sera). Autoantibody binding to the spinal cord characteristically detected the substantia gelatinosa, a less-myelinated region of high synaptic density involved in sensory-motor integration. Detectable immunoreactivity was most frequent after motor complete SCI (grade AIS A/B, 22%, 8/37 sera) being associated with autonomic decentralization. In conjunction, the neuropathological study demonstrated lesional spinal infiltration of B-cells (CD20, CD79a) in 27% (6/22) of the SCI patients, presence of plasma cells (CD138), and IgG and IgM antibody synthesis colocalized to areas of activated complement (C9neo) deposition. Longitudinal CSF analysis of an additional single patient demonstrated de novo (IgM) intrathecal antibody synthesis emerging with late re-opening of the blood spinal cord barrier (BSB).

Discussion: This study provides immunological, neurobiological, and neuropathological proof-of-principle for an potential antibody-mediated autoimmunity response emerging in a subpopulation of SCI patients starting about three weeks after SCI. Emerging autoimmunity directed against spinal cord and neuronal epitopes suggests the existence of para-traumatic CNS autoimmune syndromes.

Motoneuronal inflammasome activation triggers neuroinflammation and impedes regeneration following sciatic nerve injury

Bernát Nógrádi, Kinga Molnár¹, Rebeka Kristóf^{2,4}, Ádám Mészáros^{1,5}, Krisztián Pajer⁴, László Siklós¹, Antal Nógrádi⁴, Imola Wilhelm^{1,6}, István A. Krizbai^{1,6}

¹Biological Research Centre, Neuronal Plasticity Research Group, Temesvári krt. 62., 6726 Szeged, Hungary

²Theoretical Medicine Doctoral School, University of Szeged, Szeged, Hungary

³Department of Neurology, University of Szeged, Szeged, Hungary

⁴Department of Anatomy, Histology and Embryology, University of Szeged, Szeged, Hungary

⁵Doctoral School of Biology, University of Szeged, Szeged, Hungary

⁶Institute of Life Sciences, Vasile Goldis; Western University of Arad, Arad, Romania

Peripheral nerve injuries are accompanied by inflammatory reactions, overactivation of which may hinder recovery. Among pro-inflammatory pathways, inflammasomes are one of the most potent, leading to release of active IL-1 β . Our aim was to understand how inflammasomes participate in central inflammatory reactions accompanying peripheral nerve injury.

After axotomy of the sciatic nerve, priming and activation of the NLRP3 inflammasome was examined in cells of the spinal cord. Regeneration of the nerve was evaluated after coaptation using sciatic functional index measurements and retrograde tracing.

In the first 3 days after the injury, elements of the NLRP3 inflammasome were markedly upregulated in the L4–L5 segments of the spinal cord, followed by assembly of the inflammasome and secretion of active IL-1 β . Although glial cells are traditionally viewed as initiators of neuroinflammation, in this acute phase of inflammation, inflammasome activation was found exclusively in affected motoneurons of the ventral horn in our model. This process was significantly inhibited by 5-BDBD, a P2X4 receptor inhibitor and MCC950, a potent NLRP3 inhibitor. Although at later time points the NLRP3 protein was upregulated in microglia too, no signs of inflammasome activation were detected in these cells. Inhibition of inflammasome activation in motoneurons in the first days after nerve injury hindered development of microgliosis in the spinal cord. Moreover, P2X4 or inflammasome inhibition in the acute phase significantly enhanced nerve regeneration on both the morphological and the functional levels.

Our results indicate that the central reaction initiated by sciatic nerve injury starts with inflammasome activation in motoneurons of the ventral horn, which triggers a complex inflammatory reaction and activation of microglia. Inhibition of neuronal inflammasome activation not only leads to a significant reduction of microgliosis, but has a beneficial effect on the recovery as well.

Evaluation of neurophysiological effects of psilocybin in chronic alcoholism using epicortical neuroprosthetics

Bettina Habelt, Dzmitry Afanasenkau³, Ivan R. Minev⁴, Rainer Spanagel⁵, Marcus Meinhardt⁵, Nadine Bernhardt¹

¹Technische Universität Dresden, Medical Faculty, Institute and Outpatient Clinics of Psychiatrics and Psychotherapy, Fetscherstr. 74, 01307 Dresden, Germany

²Leibniz Institute of Polymer Research Dresden, Dresden, Germany

³Biotechnology Center (BIOTEC), Center for Molecular and Cellular Bioengineering (CMCB), Technische Universität Dresden, Dresden, Germany

⁴Department of Automatic Control and Systems Engineering, University of Sheffield, Sheffield, United Kingdom

⁵Institute of Psychopharmacology, Central Institute of Mental Health, Medical Faculty Mannheim, University of Heidelberg, Mannheim, Germany

*MM and NB share last authorship

Taking one drug to treat the addiction on another seems hardly intuitive. However, recent studies indeed revealed significant improvements in alcohol use disorders following administration of psilocybin[1,2], the main psychoactive compound within the mushroom genus *Psilocybe*. Psilocybin targets the serotonergic system with the receptor 5-HT_{2A} being the most potent binding site. Alcohol addicted subjects display reduced serotonin levels and 5-HT_{2A} receptor binding which have been associated with stress-induced anxiety and an increased relapse risk[3]. Further, serotonin receptors are highly enriched in the prefrontal cortex, a key structure in mediating attention to drug-related cues, craving and self-control[4]. Impaired neurotransmission translates into disturbed prefrontal electrophysiological activity measurable through parameters like neural oscillations and event-related brain potentials.

In the present study we investigated the impact of long-term alcohol exposure and acute psilocybin administration (2.5 mg/kg, i.p.) on such biomarkers in an established animal model of compulsive alcohol consumption. Thereby, animals (n = 10 male Wistar rats) passed through alternating phases of free access to alcohol and deprivation over 1 year. We recorded neural activity using a 3D-printed multielectrode array consisting of soft silicones and a conductive platinum composite[5]. The devices were implanted epidurally above the medial prefrontal cortex during the final 2-week period of alcohol deprivation. In awake animals, a two-tone passive auditory oddball paradigm was employed to elicit event-related potentials (ERPs) and oscillations (EROs) indicating stimulus perception, attentive processing, decision making and cognitive control – functions known to be affected in substance use disorders.

Compared to a drug- and alcohol naïve control group (n = 10), alcohol-addicted animals displayed reduced ERP amplitudes of P1N1 and N1P2 components and decreased and later peaking event-related oscillatory activity within delta, theta, alpha and beta frequency bands indicating deficits in sensory gating and early attentive filtering. Only in the gamma range, long-term alcohol consumption induced an increased oscillatory power. We further observed a maximum power within higher beta frequency ranges in alcoholic animals compared to naïve controls where low beta frequencies dominated. High beta frequency and gamma activity

have been associated with a state of hyperarousal and increased relapse probability[6,7]. Acute application of psilocybin increased ERP amplitudes in the alcohol-detoxified animals, most notably of P1N1 and N1P2 components. Likewise, EROs displayed elevated bandpowers over the whole frequency range. Further, psilocybin shifted maximum beta powers to lower frequency ranges. Also compared to naïve controls, psilocybin pushed neural activity as revealed by reduced peak latencies of most ERP components and increased P1N1 amplitudes. Event-related oscillatory activity differed to controls predominantly in the gamma frequency range revealing increased and earlier peaking bandpowers. In healthy individuals, gamma activity is associated with highly demanding cognitive processes [8] that psilocybin might facilitate. These findings provide further insights into the neuroenhancing effects underlying the therapeutic potential of psilocybin and support its utilisation in targeted interventions based on individual cognitive biomarkers.

References

1. Bogenschutz, M. P. et al. Percentage of Heavy Drinking Days Following Psilocybin-Assisted Psychotherapy vs Placebo in the Treatment of Adult Patients With Alcohol Use Disorder: A Randomized Clinical Trial. *JAMA Psychiatry* 79, 953 (2022).
2. Bogenschutz, M. P. et al. Psilocybin-assisted treatment for alcohol dependence: A proof-of-concept study. *J. Psychopharmacol. (Oxf.)* 29, 289–299 (2015).
3. Belmer, A., Patkar, O. L., Pitman, K. M. & Bartlett, S. E. Serotonergic Neuroplasticity in Alcohol Addiction. *Brain Plast.* 1, 177–206 (2016).
4. George, O. & Koob, G. F. Control of craving by the prefrontal cortex. *Proc. Natl. Acad. Sci.* 110, 4165–4166 (2013).
5. Habelt, B. et al. A Multimodal Neuroprosthetic Interface to Record, Modulate and Classify Electrophysiological Biomarkers Relevant to Neuropsychiatric Disorders. *Front. Bioeng. Biotechnol.* 9, 770274 (2021).
6. Courtney, K. E. & Polich, J. Binge Drinking Effects on EEG in Young Adult Humans. *Int. J. Environ. Res. Public Health* 7, 2325–2336 (2010).
7. Huang, Y., Mohan, A., De Ridder, D., Sunaert, S. & Vanneste, S. The neural correlates of the unified percept of alcohol-related craving: a fMRI and EEG study. *Sci. Rep.* 8, 923 (2018).
8. Jafari, Z., Kolb, B. E. & Mohajerani, M. H. Neural oscillations and brain stimulation in Alzheimer's disease. *Prog. Neurobiol.* 194, 101878 (2020).

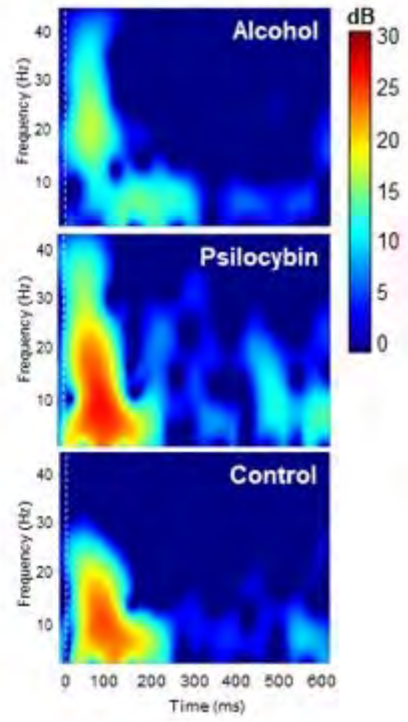
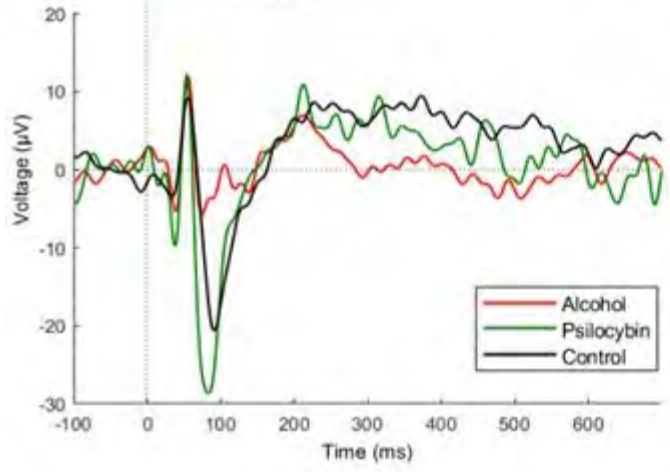

Hopper by name, hopper by nature. Decision-making processes underlying the locust startle response.

Yannick Günzel, Hannes Kübler², Einat Couzin-Fuchs^{2,3,4}

¹International Max Planck Research School for Quantitative Behaviour, Ecology and Evolution from lab to field, 78464 Konstanz, Germany

²Department of Biology, University of Konstanz, 78464 Konstanz, Germany

³Department of Collective Behavior, Max Planck Institute of Animal Behavior, 78464 Konstanz, Germany

⁴Centre for the Advanced Study of Collective Behaviour, University of Konstanz, 78464 Konstanz, Germany

Swarms of the migratory desert locust can extend over several hundred square kilometres, and starvation compels this ancient pest to devour everything on its path. However, despite the plague's enormous socio-economic impact, estimated to affect ten per cent of humanity, only little is known about their collective decision-making processes. Here we intend to shed light on these by combining eye-opening field observations, controlled lab experiments, and fine-scale recordings from descending neurons.

Deciding where to go and detecting danger along the way is crucial for survival. In the case of locust marching bands, animals navigate towards food sources or away from threats by combining individually acquired and socially derived information. In the case of an approaching predator, for example, a locust could detect the nearing danger based on its looming silhouette (environmental stimulus), based on the salient startle response (jump) of others (social stimulus), or based on a combination of both. In either case, the decision on how to respond is crucial as it could save the animal's life (true-positive vs false-negative response) or save valuable energy resources (true-negative vs false-positive response).

We address these vital decision-making processes by studying the initiation and propagation of startle responses in gregarious desert locusts. We start by describing the dynamics of information spread and response cascade in field experiments with marching locust bands. Here, our primary focus lies on the sequence of responding animals and their behavioural states at the time of the stimulus onset. Next, utilizing systematic, controlled lab experiments, we mapped the factors impacting an individual's response probability and identified a non-linear relationship between stimulus intensity and response. Mapping the stimulus-response characteristics of single, freely moving animals allows us to predict how these propagate in the group context and give insight into neuronal evidence accumulation processes. For this study, we couple behavioural experiments with recordings from descending motion detection neurons while animals interact with social and environmental looming stimuli in a tethered virtual environment context.

Here we shine a new light on the principles underlying the orthopteran jump by employing an overarching, naturalistic approach. On the one hand, we hope that this will give insight into the collective decision-making processes of a harmful pest species. On the other hand, we aim to unravel further details on the activity profiles of descending, looming-sensitive neurons.

Rho-kinase involvement in subretinal fibrosis

Yuebing Li, Souska Zandi¹, Laura Jahnke^{1,2}, Volker Enzmann¹

¹Dept. of Ophthalmology, Inselspital, University of Bern.

²Graduate School for Cellular and Biomedical Sciences, University of Bern.

Background: Subretinal fibrosis is not only a chronic process responsible for the pathogenesis or treatment failure of many degenerative retinal diseases but also one of the important causes of irreversible visual impairment in patients. CNV-related subretinal fibrosis in age-related macular degeneration (AMD), fibrovascular membranes in diabetic retinopathy (DR), proliferative vitreoretinopathy (PVR) and epiretinal membranes (ERM) are one of them, limiting the long-term visual prognosis of affected patients. To date, limited successful treatment options for retinal scarring exist. Herein, we aim to investigate the impact of anti-fibrotic compounds on ocular fibrosis. Therefore, we established a time-dependent animal model of subretinal fibrosis and investigated the effect of rho-kinase (ROCK) isoform-specific inhibition on ocular fibrosis.

Methods: To induce CNV-related fibrosis, we used a 532-nm laser inserted in a slit-lamp delivery system. After the development of fibrosis on day 35, C57BL/6 mice were treated intraperitoneally every day with fasudil or belsumodil for two weeks. We performed optical coherence tomography (OCT), autofluorescence and fluorescence angiography every week up to day 49 after laser injury (n=6 mice per timepoint) to document fibrotic changes over time. In addition, we screened choroidal flat mounts and eye sections for CNV and fibrosis using immunohistochemistry and Western blot (WB).

Results: From day 21 to day 49 after laser injury of mice eyes CNV and leakage decreased but subretinal fibrosis increased in OCT and fluorescence angiography images. The expression of collagen 1 in lesions of choroidal flat mounts increased, whereas isolectin B decreased. Our WB results show that active CNV reached a maximum on days 7 to 14, after which it began to regress and almost completely disappeared from days 21 to 35 post-laser when fibrosis increased. After treatment, the volume of fibrosis decreased, and both ROCK inhibitors significantly reduced subretinal fibrosis in vivo.

Conclusions: The current results indicate that rho-kinase might play a role in ocular fibrosis. The ROCK inhibitors fasudil and belsumodil may have therapeutic potential for the treatment of subretinal fibrosis in neovascular age-related macular degeneration and other retinal degenerative diseases with scarring.

Symposium

S16: A new look at neuronal circuits after CNS injury: mechanisms for vulnerability and repair

[S16-1](#) Adult axon guidance to reform a functional neuronal circuit in the visual system
Homaira Nawabi

[S16-2](#) Chemogenetic control of circuit vulnerability and neuroinflammation in TBI
Francesco Roselli

[S16-3](#) Age of injury-dependent locomotor circuit plasticity after a spinal cord injury
Aya Takeoka

[S16-4](#) Bridging the gap after SCI
Radhika Puttagunta

[S16-5](#) Remodeling of the neuronal extracellular matrix
Svilen Veselinov Georgiev, Tal Dankovich, Silvio O. Rizzoli

Adult axon guidance to reform a functional neuronal circuit in the visual system

Homaira Nawabi¹

¹Univ. Grenoble Alpes, Inserm, U1216, Grenoble Institut Neurosciences, 38000 Grenoble, France

Unlike young neurons, the ones from the mature central nervous system (CNS) fail to regenerate after traumatic injuries or in the case of neurodegenerative diseases. The inability of the CNS to regenerate leads to motor, sensitive and/or cognitive impairments. By using the visual system, we have shown that co-activation of mTOR, JAK/STAT and c-myc pathways in RGC induces unprecedented long-distance regeneration in the mouse (Belin et al., 2015). However, like in other regeneration models, regenerating axons display many guidance defects leading to potential aberrant circuit formation, impairing functional recovering (Belin et al., 2015; Pernet & Schwab, 2014). We propose to address the question of adult axon guidance by first analyzing the landscape of guidance molecules expression by mass spectrometry in mature brain. We showed that manipulating guidance molecules in mature visual system modifies regenerating axons trajectories. Then we focused on the innervation of the most proximal RGC axons target: the suprachiasmatic nucleus (SCN). The SCN is the pacemaker of circadian rhythms and it specifically innervated by the intrinsically photosensitive RGC (ipRGC). Surprisingly in our regeneration model, growing axons avoid the SCN. This effect is not due to a loss of ipRGC which are able to survive and regenerate. By screening guidance cues expression in adult, we identified repulsive guidance cues, expressed by mature SCN and their receptor within the retina ganglion cells. Ex-vivo regenerating RGC axons are repelled by these proteins and their inhibition within the SCN change mature axons response to SCN explant. Their modulation in vivo, after optic nerve injury, drastically increases SCN innervation. This circuit is able to respond to light as postsynaptic neurons within the SCN are activated. These results highlight that axon guidance is still effective in mature visual system to control the formation of visual circuits in injured conditions.

Chemogenetic control of circuit vulnerability and neuroinflammation in TBI

Francesco Roselli¹

¹Ulm University, Neurology, Helmholtzstrasse 8, 89081 Ulm, Germany

Background: Current strategies for the acute treatment of TBI aim at suppressing neuronal hyperactivity and excitotoxicity and at reducing the overall neuronal metabolic burden. What is the impact of reduced activity on neuronal vulnerability?

Aims: We aimed at investigating the consequences of increased or decreased cortical neuronal activity upon TBI, and at providing mechanistic links between neuronal activity and multiple pathophysiological cascades associated with TBI.

Methods: We used a PSAM/PSEM chemogenetic system to control the firing of Parvalbumin Interneurons upon TBI; DREADDGq was used to control principal neurons firing in TBI. Genetically-encoded Calcium buffers were used to block activity-dependent transcriptional programs in neurons. Microglia was characterized by targeted transcriptomics and multiplexed immunohistochemistry. Relevant mediators were assessed by ELISA in CSF samples from a clinical cohort (n=42) of TBI.

Results: Chemogenetic control of PV interneurons in TBI revealed that reduced inhibition is neuroprotective, but full suppression of inhibition is neurotoxic. Likewise, chemogenetic sustain of firing is neuroprotective but only if neuronal nuclear Calcium signaling is active. Blockade of neuronal nuclear Calcium results in a massive increase in reactive microglia with phenotype related to neurodegeneration. Target transcriptomics and AAV-mediated re-expression reveal that Osteoprotegerin (OPG) is a neuronal factor that limits microglia activation upon TBI. Indeed, OPG is upregulated in the CSF of human patients.

Conclusions: Our data show that profound suppression of neuronal activity after TBI increases neuronal vulnerability, whereas sustaining a degree of neuronal firing is protective. We show that neuronal activity regulates the secretion of mediators of neuro-glia interaction; among these, OPG is for the first time revealed to reduce microglia reactivity in response to neuronal firing in TBI. We demonstrate that these processes are ongoing in human patients and have therefore translational potential.

Age of injury-dependent locomotor circuit plasticity after a spinal cord injury

Aya Takeoka^{1,2}

¹VIB-NERF, Leuven, Belgium

²KU Leuven, Department of Neuroscience, Leuven Brain institute imec, Leuven, Belgium

Age is one of the defining factors for functional outcomes after a traumatic injury to the central nervous system. Both neuronal intrinsic and extrinsic factors contribute to age of injury-dependent plasticity. Immature neurons are more resilient to trauma and exhibit robust regeneration capabilities than mature neurons. In addition, the scar environment of juvenile animals is more permissive to growth than that of adults, supporting the sprouting and regeneration of neurons to establish novel connections. While these findings highlight the regenerative ability of injured cells themselves, our recent work reveals that circuits located at a distance from the injury site also undergo reorganization depending on the age of injury.

Severe spinal cord injury to the mature nervous system leads to irreversible paralysis below the lesion. In contrast, a complete thoracic lesion just after birth leads to proficient hindlimb locomotion without brain input as an adult. How the spinal cord achieves such striking functionality remains unknown. We uncover age of injury-dependent divergent synaptic connectivity from interneurons to motor neurons. Adult injury prompts neurotransmitter switching of spatially defined excitatory interneurons to inhibitory phenotype, promoting inhibition at synapses interfacing motor neurons. In contrast, neonatal injury causes synaptic sprouting of identical populations to facilitate excitation. Furthermore, genetic manipulation to mimic inhibitory phenotype observed after adult injury by excitatory interneurons abrogates autonomous locomotor functionality in neonatally injured mice. In comparison, attenuating inhibitory phenotype improves locomotor recovery after adult injury. Together, our study demonstrates that flexible neurotransmitter phenotype of defined excitatory interneurons steers locomotor capacity after injury.

Bridging the gap after SCI

Radhika Puttagunta¹

¹Heidelberg University Hospital, Spinal Cord Injury Center, Experimental Neuroregeneration, Schlierbacher Landstr. 200A, 69118 Heidelberg, Germany

Biomaterial engineering using alginate capillary hydrogels (ACHs) is a promising strategy to promote axonal regrowth following spinal cord injury, given its mechanical tunability, directed growth guidance, and permissive growth substrate. However, due to improper host-implant integration and fibroglial scar formation around the ACH, functional axonal regrowth beyond the lesion is marginal. Recent advances in neuronal mechanobiology have renewed interest in optimizing the mechanical properties of biomaterials to match the host tissue, reduce foreign body response to provide seamless integration. So far, the impact of biomaterial mechanics on the injured spinal cord has not been investigated. Here, we examine whether the stiffness-adjusted ACH benefits implant integration and axonal growth potential. Following a rat cervical (C5) lateral hemisection spinal cord injury, polypeptide-modified ACHs with stiffness ranging from 20kPa to 1kPa, approaching the stiffness of adult rat spinal cord, were implanted into the lesion site. Four weeks post-implantation, the softest hydrogel attracted the most cells through the capillaries compared to the stiffest one. Interestingly, greater hydrogel stiffness led to increased surrounding astrocytic, microglia, and macrophage responses. Axon quantification showed regenerating axons are significantly increased in the softest hydrogels in stark contrast to the stiffest hydrogel, specifically for serotonergic axons. On the other hand, analysis of the axonal growth orientation with AngelJ revealed that axons in the stiffest hydrogel capillaries are primarily oriented in the rostral-caudal direction of the spinal cord, while axons in the softest hydrogel capillaries grow in a more random pattern. Next, we will use atomic force microscopy to examine the mechanics of integration. Taken together, these results suggest that approximating biomaterial viscoelasticity to that of the injured spinal cord is beneficial for neural repair.

Remodeling of the neuronal extracellular matrix

Svilen Veselinov Georgiev, Tal Dankovich^{1,2}, Silvio O. Rizzoli^{1,3}

¹University Medical Center Göttingen, Institute for Neuro- and Sensory Physiology, Göttingen, Germany

²International Max Planck Research School for Neurosciences, Göttingen, Germany

³Biostructural Imaging of Neurodegeneration (BIN) Center, Göttingen, Germany

The brain extracellular matrix (ECM) is a lattice-like structure that occupies the intercellular space in the central nervous system (CNS). The ECM constituents are extremely long-lived and are widely believed to provide stability in the brain. They are presumed to be renewed only rarely, in response to neuronal activity, by the activation of matrix metalloproteinases (MMPs), that cleave the existing ECM components, followed by de novo ECM protein synthesis. However, various studies have demonstrated that synapses change their structural organization in a minute to hour time scale, suggesting that other mechanism must play a crucial role in ECM remodeling. In the past, we demonstrated that tenascin-R (TNR) is being recycled over the course of approximately 3 days. This process involves trafficking of TNR molecules to the Golgi and it's perturbation leads to impairment in synaptic activity. Here we now report that the proteoglycan Neurocan (Ncan) shows similar dynamics in neurons. Ncan has been involved in processes of dendritic spine removal and axonal path-finding during development as well as inhibition of axon regeneration after brain injury. Alongside its role during development, variation in the Ncan gene has been described as a risk factor for schizophrenia and bipolar disorder. Our data reveal an enrichment of Ncan at the synapse and also suggest TNR-like recycling of Ncan in neurons, within a similar time-period of around 3 days. Thus, our findings indicate that another vital ECM component might undergo similar recycling process.

Symposium

S17: Moving the body: communication, coordination and control in neuromechanical systems

- [S17-1](#) *Drosophila* leg campaniform sensilla as biomimetic strain sensors in fly-like robot legs
Gesa F. Dinges, William P. Zyhowski, Clarissa A. Goldsmith, Till Bockemühl, Ansgar Büschges, Nicholas S. Szczecinski
- [S17-2](#) Contribution of glial cells during action selection in *Drosophila* larvae
Amber Amrei Krebs, Christian Klämbt
- [S17-3](#) Neuronal mechanisms for sensorimotor flexibility in *Drosophila*
Jan M. Ache
- [S17-4](#) Biomimetic Robots as Tools for Understanding how the Nervous System Moves the Body
Nicholas Stephen Szczecinski
- [S17-5](#) Integration of descending and peripheral sensory signals by spinal cord interneurons
Marie-Claude Perreault

***Drosophila* leg campaniform sensilla as biomimetic strain sensors in fly-like robot legs**

Gesa F. Dinges¹, William P. Zyhowski¹, Clarissa A. Goldsmith¹, Till Bockemühl², Ansgar Büschges², Nicholas S. Szczecinski¹

¹West Virginia University, Department of Mechanical and Aerospace Engineering, 949 Engineering Sciences Building, 26505-6070 Morgantown, USA

²University of Cologne, Institute of Zoology, Zùlpicher Street 47b, 50674 Cologne, Germany

Insects achieve adaptable locomotion through limb sensory organs that monitor motor output. Their dynamic feedback onto central network components both modifies and reinforces limb movements. Sensory organs called campaniform sensilla (CS) are found grouped on the legs of *Drosophila melanogaster*, comprising 42 neurons in each leg, each associated with a cuticular cap embedded within the cuticle. Found throughout the surface of insect exoskeletons, they encode the highly dynamic strains that occur in the cuticle.

Previously, we have shown using optogenetic manipulations in intact walking flies that CS affect inter- and intraleg coordination. Furthermore, the effects of transient inhibition of individual sensors are sufficient to alter walking kinematics. While connecting the effects of functional manipulations with CS morphology, scanning electron microscopy demonstrated interindividual differences in the relative positions and arrangement of CS caps in the trochanteral and femoral fields. In current investigations into the relevance of sensor location for the motor network, we have implemented a field of strain sensors in 3D-printed leg models. These models are based on nano-computed tomography that consist of materials mimicking the cuticle, elastic material below the CS cap, and the strain-amplifying collars of CS. By manipulating the orientation of the artificial sensor field as well as individual sensors within it, we can see how fine morphology affects strain sensing.

Preliminary experiments in legs based on those of stick insects, with two simplified groups of strain sensors, have shown a clear relationship between sensor location, strain sensing, and the step cycle. We implemented the CS variability seen on the *D. melanogaster* tibia in a robotic leg stepping with insect-like kinematics. The implementation of cuticle-like materials and elastic CS caps allow us to investigate the interplay between sensor orientation and arrangement during measurements of cyclic strain.

Understanding biomechanical and neurobiological interfaces in the context of species-specific biomechanics requires an interdisciplinary approach. This work will help elucidate the importance of sensor morphology in limb movements and will aid in the understanding of how nervous systems receive and integrate sensory information.

Contribution of glial cells during action selection in *Drosophila* larvae

Amber Amrei Krebs, Christian Klämbt¹

¹University Münster - WWU, Institute of Neurobiology, Badestraße. 9, 48149 Münster, Germany

Neurons sense, integrate and compute stimuli and can generate action potentials along their axons. The action potentials are associated with an electric field which can influence gating probability of voltage-gated ion channels on closely apposed axons. This phenomenon is known as ephaptic coupling and can be blocked by processes of wrapping glia (WG). Upon optogenetic activation of sensory neurons in the absence of wrapping glia, ephaptic coupling was suggested to cause a seizure like phenotype, whereas activation of a central command neuron in the absence of wrapping glia results in a positive feedback loop between sensory and motor neurons. In addition central astrocyte-like (ALG) and cortex glia (CG) can modulate and fine tune neuronal activity by affecting synaptic transmission or secretion of gliotransmitters.

In order to directly show that ephaptic coupling events are responsible for the different locomotor phenotypes I performed additional optogenetic activation experiments. For this I utilize two major circuits governing larval escape reactions representing to action selection paradigms. The Goro circuit triggers sideways rolling. It is normally activated by the md4 sensory neurons. The Wave circuit triggers backwards locomotion and is activated by spatially restricted sensory input. To test whether an ephaptic loop exists between activated Goro neurons and sensory input neurons, I simultaneously ablated the md4 sensory neurons and the wrapping glia while activating the Goro neurons, as well as the Goro-neurons and the wrapping glia while activating sensory neurons. The results of these studies suggest that wrapping glial cells not only affect ephaptic coupling to control larval locomotion.

While the rolling inducing Goro-circuit depends on wrapping glia, optogenetic activation experiments show that the Wave circuit governing forward and backwards crawling is not affected by the presence or absence of wrapping glia. To address whether central glia are also involved, I turned to the neuropil associated glial cells, astrocyte-like and ensheathing glia (EG). First results suggest that these glial cells influence neuronal activity in the Wave escape circuit by means of exocytosis-mediated signaling. Inhibiting exocytosis in either glial cell type prevents the selection of the backwards crawling behavior in response to activation of Wave neurons.

In conclusion, peripheral and central glial cells are required in a circuit specific manner for proper locomotion and action selection. While in the CNS ephaptic coupling processes appear unlikely, they might exist in the PNS. Live imaging experiments using GCaMP8s are in progress and will be presented.

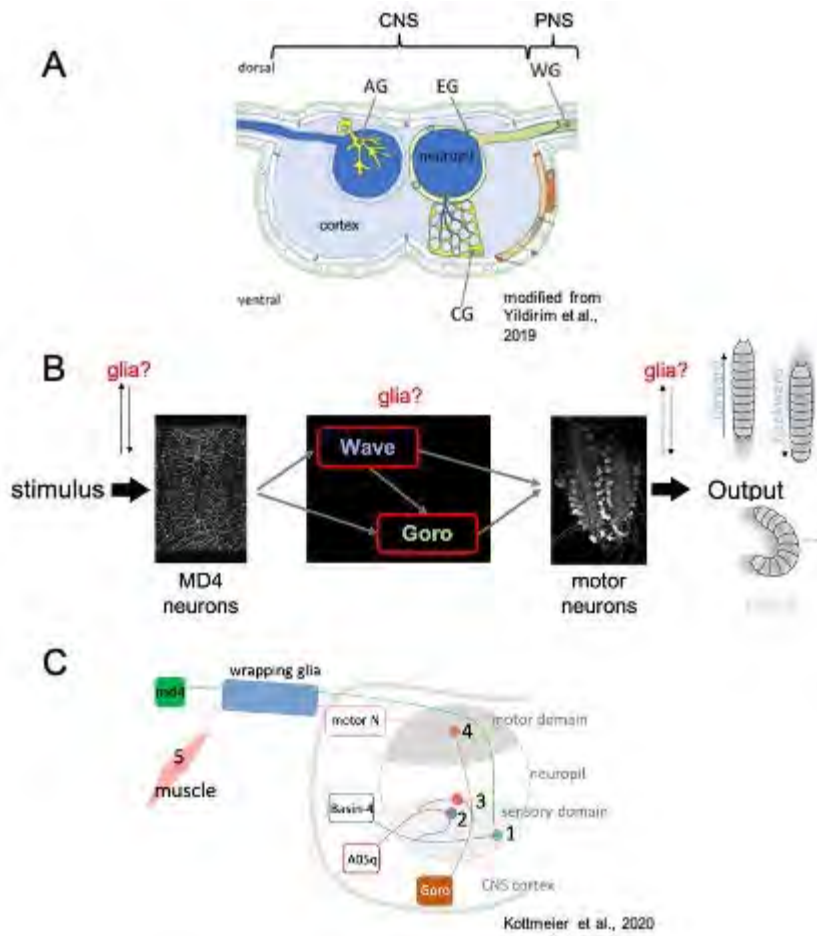

(A) Schematic view of glial cells in *Drosophila* larvae, (B) Larval escape behaviors and action selection, (C) Schematic Goro-Circuit

Neuronal mechanisms for sensorimotor flexibility in *Drosophila*

Jan M. Ache¹

¹University of Wuerzburg, Neurobiology and Genetics, Am Hubland, 97074 Wuerzburg, Germany

To ensure survival in an ever-changing, complex world, animal behavior needs to be flexible and adaptive. Nervous systems have evolved to enable behavioral responses to a wide variety of sensory stimuli, but the adequate response to a given stimulus depends on internal demands and the context in which it occurs. Accordingly, behavioral and internal states affect sensorimotor processing. For example, locomotion modulates responses of neurons in the visual system, and hunger promotes foraging behavior and sensitizes olfactory sensory neurons. Despite their ubiquitous importance, the neuronal mechanisms enabling state-dependent sensorimotor flexibility are not well understood. My lab aims to shed light on these mechanisms by leveraging the power of neurogenetics, electron microscopy-based circuit reconstruction, and *in-vivo* patch-clamp recordings in behaving *Drosophila*.

In this talk, I will focus on the key role of descending neurons (DNs) in mediating adaptive locomotion and sensorimotor flexibility. In *Drosophila* and other insects, environmental sensory cues are integrated by numerically large and complex peripheral and central circuits in the brain. From there, filtered and processed information is conveyed to motor centers in the ventral nerve cord, the insect analogue to the spinal cord, through a bottleneck of only about 500 pairs of DNs. Hence, a small population of DNs is responsible for initiating, modulating, and terminating a plethora of motor behaviors in *Drosophila*. Using optogenetic activation and silencing experiments, we and others identified DNs controlling aspects of locomotion, such as turning, slowing down, speeding up, and other behaviors. Thus, it is possible to assign a specific behavioral role to individual DNs.

By recording DN activity in behaving flies, we quantified their sensory responses and analyzed how their activity correlated with motor output. These experiments revealed how individual DN activity contributes to modulating behavior on a moment-to-moment basis. To analyze how DN activity is orchestrated in a state-dependent manner, we performed experiments in which flies underwent changes in behavioral and internal states, which had strong effects on DN activity. For example, most DN activity involved in controlling aspects of walking was gated out and rendered unresponsive to sensory stimuli during flight. Vice versa, DN activity involved in controlling flight-related behaviors was unresponsive in resting and walking flies. This suggests DN populations are gated in a way that ensures the brain only has access to motor pathways driving behaviors that are adaptive in a given behavioral state. One mechanism underlying this state-dependent DN gating is neuromodulation. Octopamine, the insect analogue of norepinephrine, for example, has been shown to render DN activity responsive in states in which they would otherwise be gated out. Therefore, we recorded from populations of modulatory neurons in the brain to quantify if and how their activity was modulated by behavioral and internal state changes. This helps us infer when and how specific populations of modulatory neurons might contribute to gating DN activity.

In combination, our approaches deliver insights into how DN population activity is orchestrated to enable adaptive action-selection in different behavioral and internal states. We believe this is one key mechanism lending flexibility to animal behavior.

Biomimetic Robots as Tools for Understanding how the Nervous System Moves the Body

Nicholas Stephen Szczecinski¹

¹West Virginia University, Department of Mechanical and Aerospace Engineering, PO Box 6024, 26506 Morgantown, USA

Robots are useful tools for studying the nervous system and its control of body mechanics. Building and controlling a robotic model of an animal is an opportunity to formulate detailed hypotheses regarding how the nervous system works and to test how such a model functions when controlling an autonomous agent, i.e., a robot. The utility of a robotic model is greatest when it mimics key characteristics of the model organism, e.g., its kinematics, dynamic scale, sensing modalities, and computation and control.

To study the sensorimotor control of legged locomotion, my group constructs robots modeled after walking insects. When modeling a particular species, the kinematics of the robot are designed to mimic those of the animal. To ensure that the same forces (e.g., gravity, inertia, elastic) dominate the motion of the robot and the animal, the speed of the robot's motion is dynamically scaled to that of the animal. To provide the control system with sensory feedback similar to that which the animal experiences, the robot has special sensors whose signals are processed through biomimetic filters. These filters can provide necessary adjustments for inherent differences in the mass, material, and other properties between the robot and the animal. To create control systems that are constrained to the types of computations the nervous system performs, the robot's control system is a real-time simulation of neural dynamics. The resulting robot is a substrate onto which to accumulate experimental discoveries and test that particular mechanisms function as understood in vivo.

The resulting robots can be used to perform experiments that would be difficult to perform in an animal. For example, in a robot, data can be recorded from every sensor on the body simultaneously as the robot performs a task. Such data may approximate what sensory feedback the animal would experience while performing the same task. Unanticipated results may inspire future experiments to describe the function of the animal's nervous system in greater detail, and the robot can be used to generate concrete hypotheses for such experiments. We believe that robots can be useful tools to supplement experimental neuroscience.

Integration of descending and peripheral sensory signals by spinal cord interneurons

Marie-Claude Perreault¹

¹Emory University, Cell Biology, 615 Michael Street, 30322 Atlanta, USA

The limited information regarding the capacity of spinal cord interneurons to be activated by, and integrate, descending and peripheral sensory signals remains a major barrier to understanding how they contribute to normal motor functions and pathological motor conditions (e.g., spasticity). Commissural interneurons (CINs) with midline-crossing axons are a group of spinal cord interneurons thought to contribute to our ability to use our body's left and right side in a coordinated manner during various movements (e.g., jumping, kicking, walking). I will present our recent work on a subset of CINs, those with descending axons (dCINs). I will show that dCINs divide into at least two distinct subpopulations, glutamatergic and GABAergic, with different ability to integrate descending reticulospinal and peripheral sensory inputs. I will also discuss how the different integrative capability of glutamatergic and GABAergic dCINs may affect how they participate in motor recovery in pathological conditions of reduced descending inputs.

Symposium

S18: Astrocyte control of neural circuit function and animal behaviour

[S18-1](#) Optogenetic activation of transient astrocytic Gq signaling in frontal cortex
Hajime Hirase

[S18-2](#) Chemogenetic activation of Gq in microglia leads to deficits in synaptic plasticity and remote memory
Marie-Luise Brehme, Zhen Yuan, Paul Lamothe, Laura Laprell, Thomas G. Oertner

[S18-3](#) An astrocytic signaling loop for frequency-dependent control of dendritic integration and spatial learning
Christian Henneberger, Kirsten Bohmbach, Nicola Masala, Eva M. Schönhense, Katharina Hill, André N. Haubrich, Andreas Zimmer, Thoralf Opitz, Heinz Beck

[S18-4](#) The role of glial cells in post-ingestive nutrient sensing and food choice behavior
Stefanie Schirmeier, Divita Kulshrestha

[S18-5](#) Structural and functional dynamics of mitochondria in astrocytes in vivo
Amit Agarwal

Optogenetic activation of transient astrocytic Gq signaling in frontal cortex

Hajime Hirase¹

¹University of Copenhagen, Center for Translational Neuromedicine, Blegdamsvej 3B, 2200 Copenhagen, Denmark

Several lines of evidence support that activation of astrocytic G protein-coupled receptors (GPCRs) leads to the secretion of molecules that modulate synaptic plasticity. To address this, transgenic mice with astrocytic expression of the optogenetic Gq-type GPCR, Opto α 1AR (aka OptoA1AR), were established, in which transient Ca²⁺ elevations similar to those in wild type mice were induced by brief blue light illumination. Activation of cortical astrocytes resulted in an adenosine A1 receptor-dependent inhibition of neuronal activity. At the behavioral level, repeated astrocytic activation in the anterior cortex gradually affected novel open field exploratory behavior, and remote memory was enhanced in a novel object recognition task. Nonetheless, astrocytic Gq-mediated effects on local cerebral blood flow appear rather inert using this least invasive and astrocyte-specific activation method. Astrocytic Ca²⁺ and cAMP elevations, the two major second messengers of GPCRs, have been implicated in glycogen breakdown. We are currently investigating roles of astrocytic signaling in mouse brain areas where glycogen presence is high.

Chemogenetic activation of Gq in microglia leads to deficits in synaptic plasticity and remote memory

Marie-Luise Brehme, Zhen Yuan¹, Paul Lamothe¹, Laura Laprell¹, Thomas G. Oertner¹

¹Center for Molecular Neurobiology Hamburg, Institute of Synaptic Physiology, Falkenried 94, 20251 Hamburg, Germany

Activation of microglia by inflammatory processes or chronic diseases has profound consequences on neurons and synapses. The details of this communication between the immune system and the brain are under active investigation. Common strategies to activate microglia, such as pharmacological manipulation (e.g. by lipopolysaccharide) or disease models (e.g. autoimmune encephalomyelitis) activate primarily the peripheral immune system, triggering a complex and protracted reaction of the whole organism. To activate microglia selectively and with precise timing we used chemogenetic activation of a Gq-DREADD, expressed exclusively in microglia. This approach allowed us to study the effect of microglia on hippocampal synaptic function with no risk of direct neuronal or astrocytic activation.

We used single cell electroporation of CA1 neurons and large field 2-photon microscopy in organotypic hippocampal slice cultures to investigate the impact of Gq-DREADD activation in microglia on synapses. We found a decreased density of excitatory synapses on CA1 pyramidal cell dendrites. Furthermore, after activation of the Gq-DREADD in microglia in vivo, Schaffer collateral synapses showed reduced long-term potentiation (LTP). Testing remote memory in water maze experiments, mice with Gq-DREADD activated microglia performed significantly worse than controls, suggesting that microglia activation affects long term memory by reducing LTP and synaptic lifetime. Together, our findings show that a “phantom inflammation” can be induced by artificial activation of second messengers inside microglia, leading to impairments in synaptic plasticity as well as neuronal communication. As there are no PAMPs or DAMPs present in the tissue, downstream effects of microglia activation could be isolated with precise timing and clear causation.

An astrocytic signaling loop for frequency-dependent control of dendritic integration and spatial learning

Christian Henneberger^{1,4,5}, Kirsten Bohmbach¹, Nicola Masala², Eva M. Schönhense¹, Katharina Hill¹, André N. Haubrich², Andreas Zimmer³, Thoralf Opitz², Heinz Beck^{2,4}

¹University of Bonn, Institute of Cellular Neurosciences, Venusberg Campus 1, 53125 Bonn, Germany

²Institute of Experimental Epileptology and Cognition Research, Medical Faculty, University of Bonn, Bonn, Germany

³Institute of Molecular Psychiatry, Medical Faculty, University of Bonn, Bonn, Germany

⁴German Center for Neurodegenerative Diseases (DZNE), Bonn, Germany

⁵Institute of Neurology, University College London, London, United Kingdom

Dendrites of hippocampal CA1 pyramidal cells amplify clustered glutamatergic input by activation of voltage-gated sodium channels and N-methyl-D-aspartate receptors (NMDARs). NMDAR activity depends on the presence of NMDAR co-agonists such as D-serine, but how co-agonists influence dendritic integration is not well understood. Using combinations of whole-cell patch clamp, iontophoretic glutamate application, two-photon excitation fluorescence microscopy and glutamate uncaging we found that exogenous D-serine reduces the threshold of dendritic spikes and increases their amplitude. Triggering an astrocytic mechanism controlling endogenous D-serine supply via endocannabinoid receptors (CBRs) also increased dendritic spiking. Unexpectedly, this pathway was activated by pyramidal cell activity primarily in the theta range, which required HCN channels and astrocytic CB1Rs. Therefore, astrocytes close a positive and frequency-dependent feedback loop between pyramidal cell activity and their integration of dendritic input. Its disruption led to an impairment of spatial memory, which demonstrates its behavioral relevance.

The role of glial cells in post-ingestive nutrient sensing and food choice behavior

Stefanie Schirmeier¹, Divita Kulshrestha¹

¹TU Dresden, Zoology and Animal Physiology, Zellescher Weg 20b, 01217 Dresden, Germany

Behavioral flexibility is an essential trait for ecological survival of any organism. For example, choosing an appropriate food source is vital. To do so, the food's nutritive value needs to be evaluated. Several studies have demonstrated that *Drosophila melanogaster* larvae and adults, as mammals, are able to distinguish between nutritious and non-nutritious carbohydrates independent of their taste. Two groups of central neurons, Diuretic Hormone 44 (Dh44)-expressing neurons and gustatory receptor 43a (Gr43a)-expressing neurons, have been implicated in postprandial sugar sensing in adult flies. Using frustrated total internal reflection (FTIR) - based larval tracking we investigated the role of those neurons in post-ingestive carbohydrate sensing and the underlying molecular mechanisms in larvae. Also here, the Gr43a expressing neurons are essential for sensing nutritive sugars such as glucose. The Gr43a receptor has been reported to be narrowly tuned to fructose, however. This raises the question how a fructose sensor is involved in sensing non-fructose sugars, like glucose. We here show that post-ingestive carbohydrate sensing involves carbohydrate conversion into fructose via the polyol pathway locally in glial cells. Glia-derived fructose is then sensed by the Gr43a neurons and leads to behavioral adaptation. Thus, in post-ingestive nutrient sensing, the glial cells play a central role in information processing and regulation of behavior.

Structural and functional dynamics of mitochondria in astrocytes in vivo

Amit Agarwal¹

¹Heidelberg University, Institute for Anatomy and Cell Biology , Im Neuenheimer Feld 307, 69120 Heidelberg, Germany

Little is known about the astrocytic mitochondrial structure, dynamics, and function in brain energetics. Recently we found that a transient opening of the mitochondrial permeability transition pore induces spatially restricted Ca^{2+} transients in astrocyte processes, providing a means to link astrocyte respiration rates and Ca^{2+} -dependent effector pathways. To record and characterize mitochondrial Ca^{2+} dynamics, we are developing novel transgenic mouse lines and AAV-based viral approaches to express fluorescent reporters and genetically encoded Ca^{2+} indicators in various astrocytic compartments. Additionally, to automatically segment mitochondria and study the structural and Ca^{2+} dynamics, we developed a machine-learning based algorithm called mito-CaSCaDe. Using 2-photon microscopy-based Ca^{2+} imaging, we found that mitochondria exhibit spontaneous fluctuations in matrix Ca^{2+} and activation of astrocytes by neuromodulators such as norepinephrine induced long-lasting Ca^{2+} transients in mitochondria. Using our mouse genetics tools, super-resolution optical (STED), and serial-section scanning electron microscopic analysis, we discovered that mitochondria in astrocytes formed densely networked structures with very limited motility. Our chronic in vivo 2-photon imaging of astrocytic mitochondria in the somatosensory cortical revealed cellular stress and neurodegeneration can induce the breakdown of these networks and compromise mitochondrial energetics. However, we found that the astrocytic mitochondrial networks are resilient and have an exceptional self-repair capacity in response to transient cellular stress. In this talk, I will present how our new results are helping us to decipher the role of mitochondria in shaping astrocyte functions in the brain.

Symposium

S19: Impact of early traumatic stress on brain development, and mental and somatic health

- [S19-1](#) Influence of type and timing of traumatic stress on brain structure and function
Christian Schmahl
- [S19-2](#) Severity of Childhood Maltreatment Predicts Reaction Times and Heart Rate Variability during an Emotional Working Memory Task in Borderline Personality Disorder
Annegret Krause-Utz, Julia-Caroline Walther, Christian Schmahl, Martin Bohus, Stefanie Lis
- [S19-3](#) Association between adverse childhood experiences and emotional face perception in a transdiagnostic sample
Katja Isabell Seitz, Maurizio Sicorello, Katja Bertsch, Sabine C. Herpertz, Corinne Neukel
- [S19-4](#) Body matters in emotion: Interoceptive processing in patients with inflammatory bowel disease
Konstantina Atanasova
- [S19-5](#) On the Interplay between Borderline Personality Features, Childhood Trauma Severity, Attachment Types, and Social Support
Anna Schulze, Leonie Cloos, Monika Zdravkovic, Stefanie Lis, Annegret Krause-Utz

Influence of type and timing of traumatic stress on brain structure and function

Christian Schmahl¹

¹Central Institute of Mental Health, Psychosomatic Medicine, Schopfheimer Str., 68239 Mannheim, Germany

Traumatic childhood experiences, such as sexual and physical abuse or neglect, represent massive stressors that impact vulnerable phases of somato-psychic development and thus have significant effects on mental and physical health, both in the short and long term. Traumatic experiences at certain developmental stages are thought to have a particular impact, for example, on specific brain structures or functions. We therefore conducted retrospective interviews to assess traumatic childhood experiences for each year of life between the ages of 3 and 17 years in a sample of approximately 100 traumatized individuals. Structural and functional magnetic resonance imaging was used to determine volumes of the amygdala and hippocampus and the reactivity of the amygdala to threatening and neutral scenes. Trauma in the age range of early adolescence (10-14 years) had the greatest impact on amygdala and hippocampal volumes. In the functional data, the presence of PTSD as well as trauma significantly predicted reactivity in the right amygdala. Traumatic experiences during a prepubertal (ages 3 & 4) and a postpubertal (ages 16 & 17) period proved particularly predictive, while overall severity of trauma did not. Comparatively, experiences of neglect were of greater significance to imaging findings than were experiences of abuse. These findings have important implications for the prevention and treatment of trauma-associated disorder

Severity of Childhood Maltreatment Predicts Reaction Times and Heart Rate Variability during an Emotional Working Memory Task in Borderline Personality Disorder

Annegret Krause-Utz¹, Julia-Caroline Walther², Christian Schmahl², Martin Bohus²,
Stefanie Lis²

¹Leiden University, Clinical Psychology, Wassenaarseweg 52, 2300 RB Leiden, Netherlands

²Central Institute of Mental Health, Mannheim; Germany

Background: Difficulties in emotion regulation are a core symptom of borderline personality disorder (BPD) and often interfere with cognitive functions, such as working memory (WM). Traumatic childhood experiences, including severe maltreatment, can contribute to emotion dysregulation, possibly mediated by changes in high-frequency heart rate variability (HF-HRV). However, it is not yet entirely understood if HF-HRV alterations underlie impaired WM during emotional distraction in BPD and if this is related to traumatic childhood experiences and to comorbid post-traumatic stress disorder (PTSD). **Objective:** Our aim was to investigate performance (reaction times, RTs) and HF-HRV during an emotional working memory task (EWMT) in relation to childhood maltreatment severity and comorbid PTSD in BPD. **Method:** Eighty-one women (n=28 healthy controls (HC) and n=53 BPD patients of which n=18 had comorbid PTSD) performed an adapted Sternberg item recognition WM task with neutral and negative social cues (interpersonal scenes from the International Affective Picture System (IAPS), and neutral, fearful, and angry faces) as distractors. Dependent variables were RTs of correct trials and HF-HRV. Childhood maltreatment was assessed with the Childhood Trauma Questionnaire. **Results:** Compared to healthy participants, patients with BPD showed prolonged RTs across all distractor conditions with social cues, regardless of their emotional valence. Patients with BPD, especially those with PTSD, demonstrated reduced HF-HRV both at rest and during EWMT. Severity of childhood maltreatment predicted longer RTs and lower HF-HRV during the EWMT. **Conclusions.** Findings suggest that adverse childhood experiences accelerate difficulties in shifting attention away from social information and that these are more pronounced in individuals with BPD. Reduced HF-HRV (low parasympathetic-tonus) may be an important psychophysiological mechanism underlying impaired WM in the presence of distracting social cues in patients with BPD, especially in those with comorbid PTSD.

Association between adverse childhood experiences and emotional face perception in a transdiagnostic sample

Katja Isabell Seitz¹, Maurizio Sicorello², Katja Bertsch^{1,3}, Sabine C. Herpertz¹, Corinne Neukel¹

¹Center for Psychosocial Medicine, Medical Faculty, Heidelberg University, Department of General Psychiatry, Voßstraße 2, 69115 Heidelberg, Germany

²Central Institute of Mental Health, Medical Faculty Mannheim, Heidelberg University, Department of Psychosomatic Medicine and Psychotherapy, C4, 11, 68159 Mannheim, Germany.

³Ludwig-Maximilians-University Munich, Department of Psychology, Leopoldstraße 13, 80802 Munich, Germany

Adverse childhood experiences (ACE) constitute a major risk factor for adult psychopathology, including posttraumatic stress disorder (PTSD), major depressive disorder (MDD), and somatic symptom disorder (SSD). One potential mechanism underlying the association between ACE and adult psychopathology is a hypervigilance to interpersonal threat. One of the most reliable functional imaging findings in individuals with a history of ACE is a heightened amygdala response to emotional, particularly threatening faces. Such amygdala hyperreactivity to threatening faces has been found in individuals with a history of ACE, both with and without different types of psychopathology. However, most studies on the association between ACE and neural threat processing focus on differential effects of different types of ACE while failing to consider timing and duration of exposure, which is critical for determining sensitive periods. Furthermore, most studies focus on individuals with one specific type of psychopathology whereas studying individuals with different types of psychopathology may allow for a better understanding whether and how ACE are linked to neural threat processing across diagnostic boundaries. Thus, the objective of this study was to investigate the association between ACE and neural threat processing in a sample of individuals with and without different types of psychopathology, specifically with regard to type, timing and duration of ACE. In addition, the role of self-reported symptoms of psychopathology in the aforementioned association was explored. A total of 141 individuals with varying levels of ACE took part in this study, including individuals with PTSD ($n = 34$), MDD ($n = 36$), SSD ($n = 35$), and healthy individuals ($n = 36$). Participants underwent functional magnetic resonance imaging during an emotional face-matching task and completed an interview measure assessing timing and duration of 10 types of ACE, the KERF-40+. In addition, participants filled out self-report measures of general psychopathology as well as symptoms of PTSD, MDD, SSD and dissociation. Results of our conditional random forest regression and multiple regression analyses will be discussed with regard to whether retrospectively reported type, timing and duration of ACE as well as symptoms of different types of psychopathology may help to predict neural threat processing in a transdiagnostic adult sample.

Body matters in emotion: Interoceptive processing in patients with inflammatory bowel disease

Konstantina Atanasova¹

¹University Medicine Mannheim, II. Department of medicine: Gastroenterology, Hepatology, Infectiology, Theodor-Kutzer-Ufer 1-3, 68167 Mannheim, Germany

The brain coordinates the regulation of vital inner processes, including blood pressure, digestion, and breathing, by flexibly reacting to external and internal changes. Interoception refers to the sensing of the internal state of the body, providing the afferent channel of the interplay between body and brain that allows homeostasis. Several physical and psychological disorders have been associated with impaired interoceptive processing. Inflammatory bowel disease (IBD) is a chronic inflammatory condition characterized by considerable emotional and social burdens for the affected individuals. Recent findings suggested an association between adverse childhood experiences (ACE) and the development of IBD and other disorders of the gut-brain interaction.

As the course of the disease includes alternating periods of relapse and remission, patients with IBD tend to monitor their body signals in order to notice early signs of worsening disease symptoms and inflammation. One factor potentially contributing to an impaired psychological well-being in patients with IBD is poor emotional functioning. It is generally agreed upon the primary role of interoceptive signals for the conscious experience of emotions and a significant body of evidence demonstrated a link between interoception and emotion perception. Thus, disturbances in how individuals perceive and appraise their bodily sensations can result in emotional dysfunctions.

We implemented three different experimental paradigms, including behavioral tasks, psychophysiological measures and questionnaires, to investigate whether patients with IBD differ in their abilities to perceive and evaluate their bodily sensations. Moreover, we were interested in the role of ACE on the link between interoceptive and emotion processing in IBD. We could demonstrate that patients with IBD do not differ in the ability to perceive their body signals, however, they tend to appraise their visceral sensations differently compared to healthy individuals. While IBD patients reported higher emotional awareness, that is, the awareness that certain changes in one's bodily sensations are triggered by the experience of emotions, they also demonstrated a significantly lower emotional reactivity, characterized by diminished bodily sensations related to the experience of positive and negative emotions. Higher levels of emotional awareness were found to intensify the perception of these emotion-related sensations, indicating a significant link between emotional awareness, as one key feature of interoceptive sensibility, and emotion processing in IBD. Our findings contribute to a better understanding of emotional dysfunctions in IBD by demonstrating a diminished experience of emotional states in the body, potentially resulting from the overgeneralized tendency to avoid visceral sensations. The observed stronger detachment from one's bodily sensations may reflect a regulatory mechanism emerging from patients' attempt to avoid distressing bodily sensations, associated with disease-related pain symptoms, which results in an altered experience of emotions. As IBD patients reporting a history of ACE constitute an especially vulnerable population and ACE was found to exaggerate disturbances in emotion processing, future psychological interventions are asked to focus on these alterations and their links to childhood maltreatment.

On the Interplay between Borderline Personality Features, Childhood Trauma Severity, Attachment Types, and Social Support

Anna Schulze¹, Leonie Cloos^{2,3}, Monika Zdravkovic², Stefanie Lis^{1,4}, Annegret Krause-Utz²

¹Central Institute of Mental Health, Department of Clinical Psychology, Medical Faculty, University of Heidelberg, Mannheim, Germany

²Institute of Clinical Psychology, Leiden University, Leiden, The Netherlands

³Research Group of Quantitative Psychology and Individual Differences, Faculty of Psychology and Educational Sciences, KU Leuven, Belgium

⁴Central Institute of Mental Health, Department of Psychosomatic Medicine and Psychotherapy, Medical Faculty, University of Heidelberg, Mannheim, Germany

Background: Adverse childhood experiences (ACE) have been associated with borderline personality disorder (BPD). Still, the interplay between types of ACE and BPD subdomains and the role of attachment and perceived social support is not entirely understood.

Objective: We investigated the importance of subdomains of BPD features, ACE, attachment and perceived social support and their specific interrelations using a graph-theoretical approach.

Participants and Setting: Online survey with 1682 participants.

Methods: We estimated a partial correlation network including the subscales of the Childhood Trauma Questionnaire (CTQ-SF) and the Borderline Scale from the Personality Assessment Inventory (PAI-BOR) as nodes. We extended the network with nodes formed by the subscales of the Adult Attachment Scale (R-AAS) and Multidimensional Scale of Perceived Social Support (MSPSS).

Results: Emotional abuse was the most central node and a bridge between the other types of ACE and BPD features. While all domains of BPD features except for affective instability were associated with emotional abuse, identity disturbances were the most central node in the community of BPD features. The association of ACE and BPD features was partly but not fully explained by attachment and social support.

Conclusion: Our findings reveal that the well-known association between ACE and BPD features is mainly driven by emotional abuse, even when taking into account attachment and social support. Our findings point to an outstanding role of identity disturbance as a link between emotional abuse and affective instability. Additionally, identity disturbance was particularly strong associated with attachment anxiety.

Symposium

S20: Hidden senses

[S20-1](#) Thermoreception in rattlesnakes – hindbrain processing and sensory periphery
Maximilian Sebastian Bothe, Harald Luksch, Hans Straka, Tobias Kohl

[S20-2](#) Characterization of the humidity receptor neurons in *Drosophila melanogaster*.
Kristina Corthals, Johan Wall, Oskar Simonson, Anders Enjin

[S20-3](#) Understanding the mechanism of hygrosensation
Ganesh Giri, Anders Enjin

[S20-4](#) Hidden senses: The magnetic compass in *Cataglyphis* desert ants
Pauline Nikola Fleischmann, Robin Grob, Valentin Leander Müller, Johanna Wegmann, Wolfgang Rössler

S20-5 Retracted

Thermoreception in rattlesnakes – hindbrain processing and sensory periphery

Maximilian Sebastian Bothe¹, Harald Luksch², Hans Straka³, Tobias Kohl²

¹University of Graz, Neurobiology and Behavior, Universitätsplatz 2, 8020 Graz, Austria

²Technical University of Munich, Chair of Zoology, Liesel-Beckmann-Straße 4, 85354 Freising-Weißenstephan, Germany

³Ludwig-Maximilians-University of Munich, Division of Neurobiology - Department Biology II, Großhaderner Straße 2, 82152 Planegg-Martinsried

Thermosensation is important for all animals to protect the body from harmful temperatures and to perform homeostatic behaviors. This general requirement triggered the evolution of thermoreceptive sensory organs that allow measurements of the ambient and internal temperature, and to determine heat gradients in the environment. Rattlesnakes are able to detect infrared (IR) radiation with bilateral pit organs, located laterally on the upper jaws. These IR sensitive organs are used for temperature regulation, hunting and defensive behavior in these animals. Pit organs are simple pinhole cameras and provide a blurred, spatially low-resolution image of the IR environment. The membrane within each pit organ is specialized to detect minute differences in heat radiation. The respective sensory elements are free nerve endings, so-called terminal nerve masses (TNMs) that are formed by dendritic endings of sensory neurons, which project through the ophthalmic and maxillary branches of the trigeminal nerve into the hindbrain. After perception by the TNMs, IR sensory information is sequentially processed in two distinct hindbrain nuclei, the “nucleus of the lateral descending trigeminal tract” (LTTD) and the “nucleus reticularis caloris” (RC), before reaching the optic tectum, where IR sensory signals are integrated with visual inputs from the two eyes.

The spatio-temporal processing of signals related to IR was systematically studied in an *in-vitro* whole brain preparation of the western diamondback rattlesnake (*Crotalus atrox*) with intact pit organs attached to the trigeminal nerve branches. This allowed investigating single cell responses in the hindbrain LTTD and RC during presentation of stationary and moving heat stimuli. This approach demonstrated a unique lateral signal inhibition that leads to a pronounced post-excitatory silencing of neurons in the LTTD and the RC, the strength of which depends on the sequence of activation of sensory elements in the pit organ. While this asymmetric lateral inhibition is only weakly represented by single neurons within the LTTD, it is robustly seen in RC neurons, suggesting the presence of a progressive motion feature extraction from IR sensory inputs in the two hindbrain nuclei. Collectively, the LTTD and RC therefore enable a contrast enhancement of blurred IR input as well as IR motion detection and provide important features for the integration of IR and visual information in the optic tectum.

Characterization of the humidity receptor neurons in *Drosophila melanogaster*.

Kristina Corthals¹, Johan Wall¹, Oskar Simonson¹, Anders Enjin¹

¹Lund University, Experimental Medical Science, Sölvegatan 19, 22362 Lund, Sweden

Humidity is an omnipresent environmental factor influencing fitness, reproductive behaviour and geographic distribution of terrestrial animals. Insects are particularly sensitive to humidity levels and common disease-vectors like the malaria mosquito (*Anopheles gambiae*) and the tsetse fly (*Glossina pallipides*), known for transmitting diseases to humans and livestock, rely on humidity cues to find their host and egg-laying sites. Even though humidity sensing (or hygrosensation) is crucial for a wide range of animals and influences their behaviour, the underlying neuronal basis remains poorly understood. Specific neurons for humidity sensing, the hygrosensory receptor neurons (HRNs), have been described and studied in a wide variety of insects. In *Drosophila melanogaster* the HRNs are located within sensory sensilla in two out of three separate chambers in the sacculus, an invagination in the posterior side of the antenna. Each sensilla houses a triad of neuronal cells: one moist neuron, one hygrocool neuron and one dry neuron. The sensilla of the two sacculus chambers have unique morphology and the HRNs in the separate chamber project their axons to different glomeruli in the antennal lobe of the brain. The current study focusses on investigating if this anatomical heterogeneity is matched by a molecular heterogeneity, using single-nucleus RNA sequencing, and a physiological heterogeneity, using in vivo calcium imaging. Furthermore, behavioural studies using Gal4-lines the specifically inactivate subtypes of HRNs are performed to assess the function to each individual neuron. We anticipate the results of this study will clarify the character of the HRNs and bring us closer to understanding the neural basis of hygrosensation.

Understanding the mechanism of hygrosensation

Ganesh Giri, Anders Enjin¹

¹Lund University, Sensory neurophysiology, Östervärnsgatan 9A, 21218 Malmö, Sweden

Along with other environmental cues, humidity plays a vital role in the life of insects to ensure that they find an ideal environmental condition required for their survival. Therefore, having a well-developed sensory system to detect and respond to changes in humidity becomes necessary. Even though humidity sensing (hygrosensation) has an impact on behavior and geographical distribution of insects, yet extraordinarily little is known about its transduction mechanism. Hygrosensory receptor neurons (HRNs) are housed inside specialized sensory hairs (hygrosensilla) on the antenna, which are similar in structure to the adjacent olfactory sensilla, except that they lack pores and are therefore shielded from the external air. It is thought provoking to think how sensory neurons that are completely isolated from the external environment can detect changes in humidity levels.

We hypothesize that HRNs respond to a mechanical activation caused by a change in the structure of the hygrosensilla. To test this hypothesis, we are using serial block-face scanning electron microscopy (SBEM) to obtain the 3D-ultrastructure of hygrosensilla from the vinegar fly *Drosophila melanogaster*. We have obtained one volume of the antenna at 70% relative humidity (RH) at 25 °C at 10x10x30 nm resolution and are in the process of obtaining further samples at different humidity levels. We anticipate that these experiments will uncover humidity-induced ultrastructural dynamics of hygrosensilla.

In parallel we are developing systems to study the population activity of HRNs using in vivo calcium imaging from the antenna. HRNs come in three types, moist neurons depolarized by increase in humidity, dry neurons depolarized by decreases and hygrocool neurons depolarized by cooling. We hypothesize that moist and dry neurons respond to mechanical deformation, and therefore act as “hair hygrometers” detecting RH. However, as RH is temperature dependent hygrocool neurons act as “calibrators” tuning the response of the moist and dry neuron. By controlling humidity and temperature levels independently while recording the calcium dynamics from all HRN types we anticipate decoding the neural basis of hygrosensation. Adding to this, we are developing the fly-on-a-ball setup to create virtual humidity and temperature arena where the tethered fly can freely navigate and position itself at the most suitable humidity and temperature level during which the multiple parameters like path traversed, speed, heading direction will be monitored. By allowing the fly to navigate this arena while modifying the activity of moist, dry and hygrocool neurons we aim to uncover the precise role of these cell types in hygrosensation.

Using these methods, it will be possible to understand the hygrosensory structure, the response and activation of hygrosensory neurons and combine this information with the observed behavior to get a bigger picture of humidity sensing in insects.

Hidden senses: The magnetic compass in *Cataglyphis* desert ants

Pauline Nikola Fleischmann^{1,2}, Robin Grob², Valentin Leander Müller², Johanna Wegmann², Wolfgang Rössler²

¹Carl-von-Ossietzky Universität Oldenburg, AG Neurosensorik/Animal Navigation, Fak.V, IBU, Carl-von-Ossietzky-Strasse 9-11, 26129 Oldenburg, Germany

²University of Würzburg, Behavioral Physiology and Sociobiology (Zoology II), Biozentrum, Am Hubland, 97074 Würzburg, Germany

Cataglyphis desert ants are skilled insect navigators that have been studied in detail in the past decades. Their main navigational strategy is path integration during their extensive foraging excursions. For that, they combine directional information from their celestial compass systems with distance information from their step integrator. In addition, foragers can use many other cues like visual landmarks, olfactory landmarks, wind direction or ground structure for spatial orientation. At the beginning of their outdoor lives, *Cataglyphis* ants perform so-called learning walks. During this transition phase from interior worker to forager, these novices do not yet collect any food, but calibrate their celestial compass systems and acquire all information necessary to become successful foragers. Novices systematically explore the surrounding of their nest. They include different types of turns. Pirouettes are turns about the ants' body axes interrupted by several stops. During the longest stopping phase, the gaze directions are directed to the nest entrance to memorize the homing direction. Since the nest entrance is a tiny hole in the ground, it is invisible from the ants' perspectives and they have to rely on a reference system to guide their gazes back. Surprisingly, novices do not rely on celestial cues, but they use the geomagnetic field as directional reference to align their gazes to the nest entrance. Systematic rotations of the horizontal component of the magnetic field induced predictable changes in gaze directions to a new, fictive position of the nest entrance. In contrast to novices, foragers do not rely on the geomagnetic field as a reference system when performing re-learning walks. Therefore, *Cataglyphis* ants preferentially use magnetic compass information during initial learning walks, and might discard it later on in favor of celestial compass information. We hypothesize that *Cataglyphis* has a polarity-sensitive magnetic compass and that magnetoreception in *Cataglyphis* is an active sensing process in the ant antennae. Novices erect their antennae conspicuously during initial learning walks. Preliminary experiments showed that novices move their antennae differently under experimental magnetic field conditions when compared to natural geomagnetic conditions. The characteristic behavioral phase of learning walks is accompanied by neuronal plasticity. High-order integration centers along the visual neuronal circuits in the ant brain undergo substantial structural changes during this learning phase. Importantly, neuronal plasticity in the central complex and mushroom bodies is triggered only when learning walks were performed under a rotating skylight polarization pattern and under natural magnetic field conditions.

Symposium

S21: Pushing and pulling: how the interplay of excitation and inhibition shapes network dynamics

[S21-1](#) Neuronal circuits overcome imbalance in excitation and inhibition by adjusting connection numbers
Anna Levina

[S21-2](#) Stability and learning in excitatory synapses by nonlinear inhibitory plasticity
Julijana Gjorgjieva, Christoph Miehl

[S21-3](#) A developmental increase of inhibition promotes the emergence of hippocampal ripples
Irina Pochinok, Mattia Chini, Tristan Manfred Stöber, Jochen Triesch, Ileana L. Hanganu-Opatz

[S21-4](#) Mechanistic model inference from observed neurodynamics
Richard Gao, Michael Deistler, Jakob H. Macke

[S21-5](#) Neuromodulatory regulation of large-scale cortical dynamics and behavioral variability in healthy humans
Thomas Pfeffer

Neuronal circuits overcome imbalance in excitation and inhibition by adjusting connection numbers

Anna Levina¹

¹Tübingen University, Computer Science Department, Maria-von-Linden 6, 72076 Tübingen, Germany

Neural circuits in the brain have highly conserved ratios of excitatory and inhibitory neurons. There are typically about 20-30% inhibitory neurons in the cortex and hippocampus. This percentage stays unchanged throughout the lifespan of an animal. The role of such a specific proportion in network dynamics remains unclear. To investigate this question, we designed an experimental platform that allowed us to reliably isolate inhibitory neurons from mouse hippocampus and culture networks with different excitatory/inhibitory ratios. We recorded population activity in developed networks using calcium imaging and single-cell activity using a patch clamp. Spontaneous network bursting emerged in cultures with various E/I ratios. Cultures with 10-80% of inhibitory neurons showed similar mean inter-burst intervals, whereas cultures with extreme 0% and 100% of inhibitory neurons developed longer inter-burst intervals. The coefficient of variation of inter-burst intervals grew with the number of inhibitory neurons. Single-cell patch clamp recordings indicated that the number of incoming connections per neuron is proportional to the number of excitatory neurons. To link the network properties and bursting dynamics, we fit networks with different ratios of excitatory and inhibitory leaky integrate-and-fire neurons with spike-frequency adaptation to the experimental data. We find that a wide range of parameters leads to the bursting dynamics observed in vitro. However, the number of inhibitory connections in fitted networks stays proportional to the number of excitatory connections. We further compared the responses of the model and cultures to blocking inhibitory receptors. Both in vitro and in silico blocking inhibition increase the mean inter-burst intervals that we can analytically explain in the simplified model. Overall, we demonstrate that hippocampal cultures adapt to different numbers of inhibitory neurons by changing the number of connections to keep incoming excitation and inhibition balanced. We confirm our results using recorded population activity, single-cell measurements, and network modeling.

Stability and learning in excitatory synapses by nonlinear inhibitory plasticity

Julijana Gjorgjieva¹, Christoph Mihal¹

¹Technical University of Munich, School of Life Sciences, Maximus-von-Imhof-Forum 3, 85354 Freising, Germany

An important task the brain needs to solve is the so-called 'stability-flexibility problem'. On the one hand, any representation in the brain, for example a long-lasting memory, has to be stable for a long time. On the other hand, new representations need to be flexibly learned at any time. How this is achieved during development is especially challenging, when many developmental mechanisms act at different scales. Learning and memory formation are implemented through the plasticity of synaptic connections, which describe how the activity in neurons is translated into changes of synaptic strength between these neurons. For example, excitatory synaptic connections are typically described to undergo plasticity driven by Hebbian mechanisms. But these mechanisms on their own are unstable, leading to either unlimited growth of synaptic strengths or silencing of neuronal activity without additional homeostatic mechanisms. To control excitatory synaptic strengths, I will present a novel form of synaptic plasticity at inhibitory synapses. Using computational modeling, I will show the importance of two key features of inhibitory plasticity, dominance of inhibition over excitation and a nonlinear dependence on the firing rate of postsynaptic excitatory neurons whereby inhibitory synaptic strengths change with the same sign (potentiate or depress) as excitatory synaptic strengths. I will demonstrate that the stable synaptic strengths realized by this novel inhibitory plasticity model achieve an excitatory/inhibitory weight set-point in agreement with experimental results. Applying a disinhibitory signal can gate plasticity and lead to the generation of receptive fields and strong bidirectional connectivity in a recurrent network. Hence, a novel form of nonlinear inhibitory plasticity can simultaneously stabilize excitatory synaptic strengths and enable learning upon disinhibition.

A developmental increase of inhibition promotes the emergence of hippocampal ripples

Irina Pochinok, Mattia Chini¹, Tristan Manfred Stöber², Jochen Triesch², Ileana L. Hanganu-Opatz¹

¹University Medical Center Hamburg-Eppendorf, Institute of Developmental Neurophysiology, Center for Molecular Neurobiology, Hamburg, Germany

²Frankfurt Institute for Advanced Studies, Frankfurt am Main, Germany

Sharp wave-ripples (SPW-Rs) are a network phenomenon most prominently observed in the CA1 area of the hippocampus and linked to memory consolidation. While SPW-Rs have been extensively studied in adults, their development is less well understood. In particular, the contribution of age-dependent excitation-inhibition changes to SPW-Rs is largely unknown. To fill this gap, we combined in vivo electrophysiology and optogenetics in mice during the first two postnatal weeks (postnatal day (P) 4-12) with neural network modeling.

We show that the broadband local-field potential (LFP) power and single-unit activity (SUA) firing rate in the hippocampal CA1 area exponentially increase during the first two postnatal weeks. Simultaneously, the LFP-inferred excitation-inhibition (E-I) ratio tilts towards inhibition. While large amplitude sharp waves are already present at P4, ripples are not detected before P10-11. Moreover, developmental changes of sharp wave features do not correlate with the presence or absence of ripples. Light manipulation of ChR2-transfected CA1 pyramidal neurons reliably induces ripple-like high frequency oscillations in mice older than P10. Younger mice responded, even at a higher light intensity, solely with augmented, yet non-coordinated spiking activity.

To elucidate the effect of the developmental E-I ratio change on the emergence of the ripples, we used a biophysically constrained two-population spiking network of leaky integrate-and-fire units representing excitatory and inhibitory neurons. In such a network, sharp wave-like external inputs elicit ripple-like activity, whereas in a network with reduced inhibition only non-coordinated spiking is evoked. Moreover, an increase in inhibitory input onto excitatory neurons affects the network activity differently from an increase in reciprocal inhibition. The former promotes the ripple-like activity emergence, whereas the latter modulates the frequency of the fast network oscillations.

Thus, CA1 ripples emerge during the second postnatal week, as the E-I ratio shifts towards inhibition. Moreover, neural network modeling suggests that the strengthening of inhibition with age is a potential mechanism underlying the developmental appearance of ripples.

strengthening of inhibition

emergence of ripples

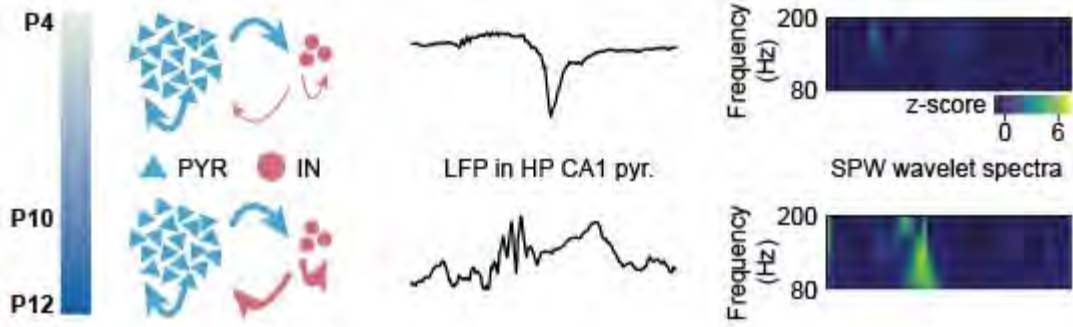

Mechanistic model inference from observed neurodynamics

Richard Gao¹, Michael Deistler¹, Jakob H. Macke^{1,2}

¹Machine Learning in Science, Excellence Cluster Machine Learning, University of Tübingen

²Max Planck Institute for Intelligent Systems, Tübingen

Neuroscience research is generating an unprecedented amount of data at multiple scales, but advancing our theoretical understanding of the brain requires mechanistic models that integrate these observations. In cognitive neuroscience, building mechanistic models that are compatible with human electrophysiological data is especially challenging, but necessary for studying the physiological variables we cannot observe. In this work, we build machine learning tools that automate mechanistic model-discovery and leverage multiscale neural data to study how cellular and network properties shape network dynamic. As an example application, we automatically infer parameters of spiking neural networks with adaptive exponential integrate-and-fire neurons using longitudinal electrophysiological recordings from brain organoids. By dissecting the discovered models, we provide insight on how specific network properties, such as the ratio of excitatory-to-inhibitory neurons, shape the emergence of synchronous network oscillations during early neurodevelopment in concert with complementary and compensatory mechanisms at the neuronal and circuit level.

Neuromodulatory regulation of large-scale cortical dynamics and behavioral variability in healthy humans

Thomas Pfeffer¹

¹Universitat Pompeu Fabra, Center for Brain and Cognition, Computational Neuroscience Group, Barcelona, Spain

Neuromodulators, such as noradrenaline and acetylcholine, have long been implicated in the regulation of cortical dynamics and behavioral state. While influential theories postulate distinct computational roles for these neuromodulators in the orchestration of cognition and behavior, a thorough understanding of their mechanisms and effects on large-scale cortical dynamics and behavior in humans is still lacking. Through a combination of whole-brain recordings of neural population activity and selective pharmacological manipulations in healthy humans, we uncovered distinct effects of noradrenaline and acetylcholine in shaping the intrinsic dynamics of large-scale cortical populations and human decision-making. Through the simulation of computational models across spatial scales, we identified possible neuronal mechanisms underlying the experimentally observed effects.

Symposium

S22: Illuminating the brain – current applications and future developments of next-generation biosensors

[S22-1](#) New optical tools for monitoring and controlling neuromodulator signaling
Tommaso Patriarchi

[S22-2](#) *In vitro* and *in vivo* characterization of improved channelrhodopsin ChRmine variants for optogenetic activation of the auditory pathway
Victoria Hunniford, Maria Zerche, Isabel Witzke, Bettina Wolf, Thomas Mager, Tobias Moser

[S22-3](#) Next generation genetically encoded fluorescent sensors for serotonin and beyond
Olivia Andrea Masseck

[S22-4](#) Optochemical approaches to control and sense glutamate receptor signaling
Andreas Reiner

[S22-5](#) Voltage imaging with Genetically Encoded Voltage Indicators: development and applications
Daan Brinks, Srividya Ganapathy, Xin Meng, Miao-Ping Chien

New optical tools for monitoring and controlling neuromodulator signaling

Tommaso Patriarchi^{1,2}

¹University of Zurich, Pharmacology and Toxicology, Winterthurerstrasse 190, 8057 Zurich, Switzerland;

²Neuroscience Center Zurich, University and ETH Zurich, Winterthurerstrasse 190, 8057 Zurich, Switzerland

Neuromodulatory systems exert profound influences on brain function. In order to understand the precise roles neuromodulators play in specific behavioral or disease states requires we need to monitor their dynamic changes with both high spatial and temporal resolution in vivo. Achieving this is very challenging with traditional approaches (e.g. microdialysis). I will talk about how, as a solution to this challenge, we developed OxLight1, a genetically encoded fluorescent orexin sensor that enables optical recording of orexin dynamics in awake behaving animals. We demonstrated the flexibility and utility of OxLight1 by monitoring natural or optogenetically-evoked orexin dynamics in vivo using fiber photometry. Furthermore, using OxLight1 we obtained for the first time a glimpse over the spatial details of orexin release in the cortex. I will highlight how we expanded our sensor design platform to other neuromodulators and I will showcase the application of neuropeptide biosensor in the development of optical tools for controlling endogenous neuropeptide signaling.

***In vitro* and *in vivo* characterization of improved channelrhodopsin ChRmine variants for optogenetic activation of the auditory pathway**

Victoria Hunniford, Maria Zerche^{1,3,4}, Isabel Witzke^{1,4}, Bettina Wolf^{1,5,6}, Thomas Mager^{1,4,6}, Tobias Moser^{1,5,6,7}

¹University Medical Center Göttingen, Institute for Auditory Neuroscience, Robert-Koch-Strasse 40, 37075 Göttingen, Germany

²University of Göttingen, Göttingen Graduate Center for Neurosciences, Biophysics, and Molecular Biosciences (GGNB), Göttingen, Germany

³Department of Otolaryngology, University Medical Center Göttingen, Göttingen, Germany

⁴Advanced Optogenes Group, Institute for Auditory Neuroscience, University Medical Center Göttingen, Germany

⁵Auditory Neuroscience and Optogenetics Laboratory, German Primate Center, Göttingen, Germany

⁶Cluster of Excellence "Multiscale Bioimaging: from Molecular Machines to Networks of Excitable Cells" (MBExC), University of Göttingen, Göttingen, Germany

⁷Auditory Neuroscience and Synaptic Nanophysiology Group, Max Planck Institute for Multidisciplinary Science, Göttingen, Germany

Background: Electrical cochlear (eCI) implants provide partial hearing restoration to individuals with severe to profound sensorineural hearing loss by directly stimulating spiral ganglion neurons (SGNs) electrically. To overcome the wide-spread electrical neural excitation generated by eCIs, stimulation of SGNs using optogenetics presents an attractive solution to address this limitation. For translating optogenetic hearing restoration, it is critical to utilize a channelrhodopsin (ChR) with low desensitization, large photocurrents, red-shifted activation, and ideally fast kinetics. ChRmine is a bacteriorhodopsin-like cation ChR (BCCR) which mediates very large peak photocurrents when compared to algal ChRs but exhibits rapid desensitization. Here we evaluate the optogenetic utility of novel ChRmine mutants we engineered for less desensitization.

Methods: *In vitro* characterization of electrophysiological properties of ChRmine mutants was performed by whole cell patch-clamp recordings of transfected neuroma glioblastoma (NG) cells expressing one of three ChRmine-mutants or the wild-type (WT) upon excitation with light at a wavelength of $\lambda = 532$ nm. For *in vivo* characterization, adeno-associated-virus (AAV) carrying transgene WT or mutant ChRmine (#3) under the human synapsin promoter were injected into the round window of neonatal C57Bl6/J mice (postnatal day 6). Six to ten weeks after injections, a laser-coupled fiber (594 nm) was inserted into the round window to measure optically evoked auditory brainstem responses (oABRs). Subsequently, the cochleae were extracted for immunohistological analysis using lightsheet microscopy to evaluate the number of transduced cells as well as membrane expression profiles.

Results: From whole cell-recording, photocurrents of the 4 ChRmine variants peaked between 514 to 518 nm. All ChRmine mutants demonstrated less desensitization than the WT as well as high light sensitivity and large stationary photocurrent densities. Eleven and eight mice were injected with the ChRmine mutant #3

and WT, respectively. oABRs were elicited in all animals, with mean thresholds of 0.79 ± 0.4 mW (mutant) and 5.7 ± 6.4 mW (WT); and with amplitudes in the range of 8 to 15 μ V during optical stimulations of 1 ms at 10 and 20 Hz (please note that 594 nm is not optimal for ChRmine). The amplitude of the oABRs dropped with stimulations rates over 150 Hz. Preliminary histological data by means of light-sheet microscopy show robust expression of ChRmine WT and mutant #3 in SGNs throughout all turns of the cochlea.

Conclusion: The ChRmine variants exhibit large photocurrents and comparatively slow kinetics, which promises robust neuronal photoactivation at moderate ChR expression levels and at low light intensities. Thus, the ChRmine mutant #3 sets a lower bound of the power requirement for optogenetic hearing restoration, with a theoretically derived threshold estimate (at the optimal wavelength) of 0.1 mW. Future work will need to speed up its deactivation kinetics and to further characterize the utility of BCCR variants for optogenetic stimulation of the auditory pathway.

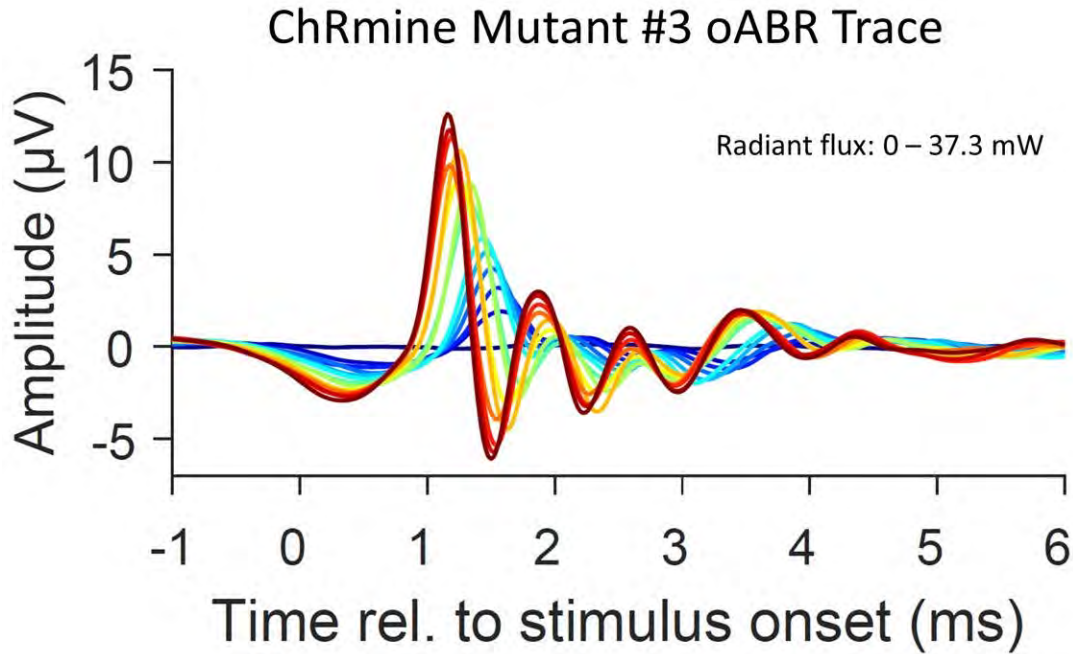

Figure 1. oABR from representative mouse expressing ChRmine mutant #3. oABR amplitude (in μ V) plotted by time to relative optical stimulus (in ms) with light intensities ranging from 0 to 37.3 mW.

Next generation genetically encoded fluorescent sensors for serotonin and beyond

Olivia Andrea Masseck¹

¹Universität Bremen, Synthetische Biologie, Leobenerstr.5, 28359 Bremen, Germany

Understanding how neuronal networks generate complex behavior is one of the major goals of Neuroscience. Neurotransmitter and Neuromodulators are crucial for information flow between neurons and understanding their dynamics is the key to unravel their role in behavior. We recently developed a new family of genetically encoded serotonin (5-HT) sensors (*sDarken*) on the basis of the native 5-HT_{1A} receptor and circularly permuted GFP. *sDarken* 5-HT sensors are bright in the unbound state and diminish their fluorescence upon binding of 5-HT. Sensor variants with different affinities for serotonin were engineered to increase the versatility in imaging of serotonin dynamics. Experiments *in vitro* and *in vivo* showed the feasibility of imaging serotonin dynamics with high temporal and spatial resolution. As demonstrated here, the designed sensors show excellent membrane expression, have high specificity and a superior signal-to-noise ratio, detect the endogenous release of serotonin and are suitable for *in vivo* imaging. In addition, we will present a new red-shifted genetically encoded calcium indicator (PinkyCaMP) that will further expand the existing toolbox to image neuronal activity.

Optochemical approaches to control and sense glutamate receptor signaling

Andreas Reiner¹

¹Ruhr-Universität Bochum, Cellular Neurobiology, Universitätsstr. 150, 44801 Bochum, Germany

Optogenetic tools enable the control and visualization of signaling processes with high spatial and temporal resolution as well as genetic specificity. Many of these tools are based on engineered opsins and fluorescent proteins, respectively. Here I want to focus on a different approach, the direct optical control of neuronal glutamate receptors using tethered photoswitchable ligands. Depending on the attachment position of the photoswitch molecule, activation or inhibition of specific receptor subtypes can be achieved in a fast, spatially confined and reversible manner. So far, this technique has been used for controlling kainate as well as NMDA receptor subtypes in different experimental paradigms. Our current investigations aim at extending this approach to another application, namely to use photoswitchable iGluRs as sensor-iGluRs, i.e. for probing the activation state of specific receptor subtypes in real time. Using repeated photoswitching protocols and patch-clamp measurements as read-out, resting, activated or inhibited receptor states can be distinguished based on their characteristic photo-responses, as demonstrated for a representative kainate receptor subunit, GluK2. Possible applications will be to monitor signaling states of various iGluR subtypes during chemical ischemia *in situ*.

Voltage imaging with Genetically Encoded Voltage Indicators: development and applications

Daan Brinks^{1,2}, Srividya Ganapathy¹, Xin Meng¹, Miao-Ping Chien²

¹Delft University of Technology, Imaging Physics, Lorentzweg 1, 2628 CJ Delft, Netherlands

²Erasmus University Medical Center, Molecular Genetics, Dr Molewaterplein 40, 3015 GD Rotterdam, Netherlands

Technologies that allow high-speed imaging of cellular dynamics are central to our ability to ask and answer new questions in cell biology and neuroscience. Here, I will focus on voltage imaging: the optical recording of membrane potentials and their fast dynamics in excitable cells. I will discuss recent developments in our lab expanding the palette of available tools and applications for voltage imaging in vitro and in vivo. I will touch upon the synergistic development of hardware, screens, targeted gene expression schemes, functionalization strategies and improved near-infrared voltage indicators and recent functional transcriptomics work that enhances the potential of voltage imaging as a diagnostic tool.

Symposium

S23: Epigenomic adaptations in CNS development

- [S23-1](#) Epigenetic mechanisms involved in cerebral cortex development
Annalisa Izzo
- [S23-2](#) Cell type - specific functions of the DNA methyltransferase 1 in cortical interneuron development
Geraldine Zimmer-Bensch, Julia Reichard
- [S23-3](#) Joint epigenome profiling reveals cell type-specific gene regulatory programs in human cortical organoids
Boyan Bonev
- [S23-4](#) Epigenome regulation in neocortex expansion and generation of neuronal subtypes
Tran Tuoc
- [S23-5](#) Spatio-temporal DOT1L-mediated regulation of basal progenitor cells during mouse cortical development
Camila Lorena Fullio, Tobias Hohl, Laura Arrigoni, Thomas Manke, Tanja Vogel

Epigenetic mechanisms involved in cerebral cortex development

Annalisa Izzo¹

¹Institute for Anatomy and Cell Biology , Dept. Molecular Embryology, Albertstr 23, 79104 Freiburg, Germany

The specification of neural composition and of neuronal networks in the six-layered cerebral cortex is fundamental for exertion of mental and cognitive tasks. Neural stem cells (NSCs) and glutamatergic neurons of the cerebral cortex are born in the ventricular (VZ) and the subventricular zone (SVZ). Furthermore, the SVZ is one of the stem cell niches of the adult nervous system and contributes to repair processes after CNS injuries in mice.

Thus, understanding the molecular mechanisms that control cell fate during neurogenesis is of utmost interest to understand one basis of cognition.

Recent data from embryonic and neural stem cells (ESC, NSC) revealed that chromatin modifying enzymes (CME) and epigenetic modifications play a pivotal role in cell fate decisions. Further, disease-associated epigenetic patterns have been observed in neurological and

psychiatric diseases . However, data covering the influence of CME on developmental programs are rare.

Here we want to give an overview of our ongoing projects about the role of the H3K79 methyltransferase DOT1L in the network of neuronal specification during brain development. In addition, we present in more details the role of the H3K4me2/3 demethylase KDM1A in controlling the gradient expression of key regional genes, thus contributing to the establishment of functional areas along the rostral-caudal axis of the developing dorsal telencephalon.

From a broader perspective our results provide new opportunities to better understand common regulatory mechanisms responsible for the structural chromatin changes required for the correct development of the human brain and their impact in human brain pathologies.

Cell type - specific functions of the DNA methyltransferase 1 in cortical interneuron development

Geraldine Zimmer-Bensch¹, Julia Reichard¹

¹RWTH Aachen University, Department of Zoology, Division of Neuroepigenetics, Worringerweg 3, 52074 Aachen, Germany

Proper brain function critically relies on tight orchestration of neuronal processes within the cerebral neocortex. For this purpose, a delicate balance between excitation and inhibition depending on defined numbers of excitatory projection neurons and inhibitory gamma-aminobutyric (GABA)-positive interneurons is indispensable. Although contributing to only 20% of the entire neuronal population in the cortex, interneurons are key for cortical processing. Defects during interneuron development are known to be associated with severe neuropsychiatric diseases such as schizophrenia, epilepsy or autism spectrum disorder. In this context, epigenetic mechanisms emerged as crucial regulators of neuronal development including cortical interneurons. In previous studies we found an essential implication of the DNA methyltransferase 1 (DNMT1) in promoting the long-range migration of inhibitory cortical interneurons generated in the embryonic pre-optic area (POA). In these cells, DNMT1 maintains their migratory morphology and survival via transcriptional regulation through crosstalk with histone modifications.

Now we found that DNMT1 is likewise involved in the migration regulation of Somatostatin (SST) expressing interneurons, which mainly derive the medial ganglionic eminence (MGE), by its canonical DNA methylation function. Interfering with Dnmt1 expression impaired their migration, which however did not rely on morphological defects. Instead, we found that DNMT1 regulates the expression of endocytosis-related genes by DNA methylation. Endocytosis is relevant in migrating neurons for the release of focal adhesive complexes. Moreover, endocytosis removes receptor-ligand signaling complexes from the cellular surface that regulate migration such as the Eph/ephrin system. We found that DNMT1 acts on both, the removal of focal adhesive and Eph/ephrin complexes. Analysis of conditional knockout embryos revealed altered migration of Dnmt1 deficient SST-interneurons. Conclusively, our data indicate that DNMT1 regulates cortical interneuron migration in a subtype-specific fashion.

Joint epigenome profiling reveals cell type-specific gene regulatory programs in human cortical organoids

Boyan Bonev¹

¹Helmholtz Zentrum München, Pioneer Campus, Ingolstädter Landstraße 1, 85764 München, Germany

Gene expression is regulated by multiple epigenetic mechanisms, which are often coordinated in development and disease. However, current multiomic methods are frequently limited to one or two modalities at a time, making it challenging to obtain a comprehensive gene regulatory signature.

Here, we describe the multiomic method 3DRAM-seq (3D genome, RNA, Accessibility and Methylation sequencing) that simultaneously interrogates spatial genome organization, chromatin accessibility, DNA methylation and gene expression at high resolution. We demonstrate that 3DRAM-seq outperforms other multiomic approaches and can be used to map cis-regulatory regions as well as chromatin loops and determine their epigenetic status. To enable the profiling of specific cell types, we combine 3DRAM-seq with immunoFACS and RNA-seq in human cortical organoids and map the epigenome landscape in radial glial cells (RGC) and intermediate progenitor cells (IPC), identifying TFs associated with a widespread epigenetic remodeling across multiple epigenetic layers. Finally, using a massively parallel reporter assay (MPRA) to profile cell-type-specific enhancer activity in human organoids, we functionally assess the role of key TFs for enhancer activation and function.

Overall, 3DRAM-seq uncovers coordinated epigenome remodeling across multiple regulatory layers, and can be used to functionally dissect the molecular logic of human brain enhancers. More broadly, 3DRAM-seq can be applied to any tissue and can be used to profile the multimodal epigenetic landscape in rare cell types.

Epigenome regulation in neocortex expansion and generation of neuronal subtypes

Tran Tuoc¹

¹Ruhr-University Bochum, Human Genetics, Universitätsstraße 150, 44780 Bochum , Germany

Evolutionarily, the expansion of the human neocortex accounts for many of the unique cognitive abilities of humans. This expansion appears to reflect the increased proliferative potential of basal progenitors (BPs) in mammalian evolution. Further cortical progenitors generate both glutamatergic excitatory neurons (ENs) and GABAergic inhibitory interneurons (INs) in human cortex, whereas they produce exclusively ENs in rodents. The increased proliferative capacity and neuronal subtype generation of cortical progenitors in mammalian evolution may have evolved through epigenetic alterations. However, whether or how the epigenome in cortical progenitors differs between humans and other species is unknown.

Here, we report that histone H3 acetylation is a key epigenetic regulation in BP amplification, neuronal subtype generation and cortical expansion. Through epigenetic profiling of sorted BPs, we show that H3K9 acetylation is low in murine BPs and high in human BPs. Elevated H3K9ac preferentially increases BP proliferation, increasing the size and folding of the normally smooth mouse neocortex. Furthermore, we found that the elevated H3 acetylation activates expression of IN genes in in developing mouse cortex and promote proliferation of IN progenitor-like cells in cortex of Pax6 mutant mouse models. Mechanistically, H3K9ac drives the BP amplification and proliferation of these IN progenitor-like cells by increasing expression of the evolutionarily regulated gene, TRNP1.

Our findings demonstrate a previously unknown mechanism that controls neocortex expansion and generation of neuronal subtypes.

Spatio-temporal DOT1L-mediated regulation of basal progenitor cells during mouse cortical development

Camila Lorena Fullio, Tobias Hohl^{2,4}, Laura Arrigoni⁴, Thomas Manke^{2,4}, Tanja Vogel^{1,2,3}

¹University of Freiburg, Institute of Molecular Embryology, Albertstr 23, 79104 Freiburg im Breisgau, Germany

²DFG Training group 2344, MeInBio

³Faculty of Biology, University of Freiburg, 79104 Freiburg, Germany

⁴Max Planck Institute of Immunobiology and Epigenetics, Freiburg, Germany

The cerebral cortex is an extremely complex structure comprised of many different cell types and is responsible for several higher-order brain functions. To produce such an intricate system, neural stem cells (NSCs) require precise spatiotemporal signals to acquire the correct cell identity at the exact moment. Even though epigenetic regulation plays a central role in cell fate decisions, the exact mechanisms remain elusive. Thus, we focus our research on DOT1L, a H3K79 methyltransferase whose involvement in cell fate decisions is undeniable.

Our group has shown that DOT1L prevents NSC premature differentiation by increasing expression of genes that regulate asymmetric cell division (Franz et al. 2019). Using cell-lineage tracing and pharmacological inhibition, we confirmed that when DOT1L is inhibited apical progenitors (APs) switch to symmetric neurogenic divisions in detriment of asymmetric self-renewal (Appiah et al, in preparation). However, the impact on basal progenitors (BPs), responsible for the evolutionary expansion of the cortex in both size and complexity (Nonaka-Kinoshita et al, 2013), is still unexplored.

We analyse conditional knockout (cKO) mice for DOT1L using the Emx1-Cre line and exploit phenotypic alterations at different points during the main phases of neurogenesis (E12.5, E14.5, E16.5). We are employing single cell (sc) methods, such as scRNA- and scATAC-seq data as well as spatial transcriptomics, from cKO and control mice, to understand how the transcriptome changes and how it correlates with modifications in chromatin accessibility. We discern the roles of DOT1L either in BPs that either inherit DOT1L deficiency from APs using Emx1-cre, or in BPs, deriving from WT APs, but in which DOT1L is deleted by activity of Eomes-Cre. We aim to get a deeper insight into the division modes and developmental plasticity of BPs and whether DOT1L also controls BP proliferation and differentiation similar to its role in APs.

As DOT1L preserves generally NSC transcriptional programs of cells dividing multiple times, the restricted proliferation potential in BPs might bear potentially novel insights into how stem cells control the tight balance between proliferation and differentiation.

Symposium

S24: Inflammatory mechanisms of epileptogenesis

[S24-1](#) Conceptual definition and neuronal mechanisms of epileptogenesis in focal epilepsies
Matthew Charles Walker

[S24-2](#) Neuroinflammation in human focal epilepsies
Eleonora Aronica

[S24-3](#) Neuroinflammation induced seizures and epilepsy: experimental models and targeted pharmacological treatments
Annamaria Vezzani

[S24-4](#) Neuro-glia-vascular interactions in brain disorders: From bench to bed
Alon Friedman

[S24-5](#) Pathogenic effects of GABA_B receptor antibodies from patients with autoimmune encephalitis on neuronal signaling and memory consolidation
Josefine Sell, Eleonora A. Loi, Vahid Rahmati, Alexander Stumpf, Torsten W.B. Götz, Dietmar Schmitz, Christian Geis

Conceptual definition and neuronal mechanisms of epileptogenesis in focal epilepsies

Matthew Charles Walker¹

¹University College London, Department of Clinical and Experimental Epilepsy, Queen Square, WC1N 3BG London, United Kingdom

Epileptogenesis refers to the transition from a non-epileptic brain to one that is prone to spontaneous seizures. The term can be applied to both congenital causes such as malformations of brain development, birth injuries and genetic factors and also acquired brain insults such as stroke, traumatic brain injury and prolonged seizures. Most experimental research has, however, focussed on acquired brain insults, in particular, those that affect the hippocampus, with the development of limbic epilepsy, which has strong parallels with the development of human temporal lobe epilepsy.

Epileptogenesis is likely due to a sequence of events involving processes such as the generation of reactive oxygen species, inflammation, breakdown of the blood brain barrier, release of growth factors and changes in gene expression. These lead to changes in neuronal excitability and increases in excitatory transmission that likely compensate for neuronal damage. This is particularly evident in hippocampal sclerosis in which there is pyramidal cell loss with compensatory sprouting of excitatory axons, and increased excitatory neurotransmission. Neurons also change their behaviour with an increased propensity for burst firing. There is growing evidence that changes in the intrinsic excitability of neurons plays a critical role, so that manipulations of intrinsic principal cell excitability using gene therapies or drugs can have a powerful anti-seizure effect. Inhibitory neurotransmission undergoes complex changes during epileptogenesis in order to maintain functionally stable brain circuitry. The result is usually neuronal networks that for the majority of time do not generate seizures but are less stable and are prone to decompensation. In particular, the alterations of inhibition during epileptogenesis are probably more effective at maintaining inhibitory offset but do not adequately compensate increases in neuronal gain.

Neuroinflammation in human focal epilepsies

Eleonora Aronica¹

¹Amsterdam UMC location University of Amsterdam, Department of Neuropathology, Amsterdam Neuroscience, the Netherlands;

²Stichting Epilepsie Instellingen Nederland (SEIN), Heemstede, the Netherlands.

Epileptogenesis is a gradual and dynamic process leading to difficult-to-treat seizures. Several cellular, molecular, and pathophysiologic mechanisms, including the activation of innate and adaptive immune responses, play a role in this epileptogenic process and associated comorbidities. Mounting evidence, obtained in human brain tissue, has emphasized the critical role of prolonged, dysregulated and maladaptive immune responses in the pathophysiological processes implicated in a large spectrum of genetic and acquired forms of focal human epilepsies. Dissecting the cellular and molecular mediators of the pathological immune responses and their convergent and divergent mechanisms, is a major requisite for delineating their role in the establishment of epileptogenic networks. The role of small regulatory molecules involved in the regulation of specific pro- and anti-inflammatory pathways and the crosstalk between neuroinflammation and oxidative stress will be addressed. The observations supporting the activation of both innate and adaptive immune responses in human focal epilepsy will be discussed and elaborated, highlighting specific inflammatory pathways as potential targets for antiseizure and/or disease-modifying therapeutic strategies.

Neuroinflammation induced seizures and epilepsy: experimental models and targeted pharmacological treatments

Annamaria Vezzani¹

¹Istituto di Ricerche Farmacologiche Mario Negri, Neuroscience, Via Mario Negri 2, 20156 Milano, Italy

Epilepsy is a chronic neurological disease characterized by an enduring propensity for generation of seizures. The pathogenic processes of seizure generation and recurrence are the subject of intensive preclinical and clinical investigations, as their identification would enable development of novel treatments that prevent epileptic seizures and reduce seizure burden. Such treatments are particularly needed for pharmacoresistant epilepsies, which affect ~30% of patients. Neuroinflammation is commonly activated by innate immune mechanisms in epileptogenic brain regions in humans and is clearly involved in animal models of epilepsy. An increased understanding of neuroinflammatory mechanisms in epilepsy has identified cellular and molecular targets for new mechanistic therapies or existing anti-inflammatory drugs that could overcome the limitations of current medications, which provide only symptomatic control of seizures. Moreover, inflammatory mediators in the blood and molecular imaging of neuroinflammation could provide diagnostic, prognostic and predictive biomarkers for epilepsy, which will be instrumental for patient stratification in future clinical studies. My talk will focus on our understanding of the IL-1 receptor–Toll-like receptor 4 axis, the arachidonic acid–prostaglandin cascade, oxidative stress and TGF- β signalling associated with blood–brain barrier dysfunction, all of which are pathways that are activated in pharmacoresistant epilepsy in humans and that can be modulated in animal models to produce therapeutic effects on seizures, neuronal cell loss and neurological comorbidities.

Neuro-glia-vascular interactions in brain disorders: From bench to bed

Alon Friedman^{1,2}

¹Dalhousie University, Medical Neuroscience, College street, B3H4R2 Halifax, Canada

²Ben-Gurion University of the Negev, Brain and Cognitive Sciences, Beer-Sheva, Israel

Interactions between cerebral blood vessels, neurons, astrocytes, microglia and pericytes form a dynamic functional unit known as the neurovascular unit (NVU). Brain micro vessels are characterized by the blood-brain barrier (BBB) – a unique anatomical and functional interface, essential for the proper function of neural circuits. The NVU-BBB cross-talk plays a key role in regulation of blood flow, response to injury, neuronal firing and synaptic plasticity. Numerous clinical studies confirm that BBB dysfunction (BBBD) is a hallmark of most common neurological disorders. BBBD can be detected within the first hours after brain injury, and may last for months. Our group was studying the mechanisms leading from BBBD to neural dysfunction and disease. We showed that BBBD induces the transformation of astrocytes, activating the innate neuroinflammatory system, promote alterations in the extracellular matrix, excitatory synaptogenesis and pathological plasticity. Together these events associated with re-wiring the local neuro-vascular network resulting in reduced seizure threshold. We identified transforming growth factor beta (TGF β) pro-inflammatory pathway as a key signaling pathway associated with astrocytic transformation and epileptogenesis. Specific small molecules blocking TGF β , and the non-specific, FDA approved blocker losartan, prevent post-injury epilepsy, highlighting potential novel interventions for the prevention of epilepsy. These pre-clinical encouraging data are now being translated back to the clinic: our recently developed imaging approaches to quantitatively assess BBBD confirm that BBBD is common after injury and in patients with drug-resistance epilepsy. Our results highlight microvascular injury and BBBD as novel diagnostic and therapeutic target in brain disorders.

Pathogenic effects of GABA_B receptor antibodies from patients with autoimmune encephalitis on neuronal signaling and memory consolidation

Josefine Sell, Eleonora A. Loi¹, Vahid Rahmati¹, Alexander Stumpf², Torsten W.B. Götz², Dietmar Schmitz^{2,3}, Christian Geis¹

¹Jena University Hospital, Section Translational Neuroimmunology, Am Klinikum 1, 07743 Jena, Germany

²Neuroscience Research Center, Cluster NeuroCure, Charité-Universitätsmedizin Berlin, Berlin, Germany

³German Center for Neurodegenerative Diseases (DZNE), Berlin, Germany

Aims:

GABA_B receptor (GABA_BR) encephalitis is an autoimmune disorder with immunoglobulin G (IgG) antibodies targeting pre- and postsynaptic GABA_BRs. Patients suffer from severe memory dysfunction and epileptic seizures. GABA_BRs are G-protein coupled receptors and mediate complex synaptic signaling in glutamatergic as well as GABAergic neurons by regulating presynaptic neurotransmitter release and postsynaptic excitability. Here we aimed to investigate the pathophysiological effect of human serum antibodies on neuronal synaptic transmission, structural changes at the synapse and memory.

Methods:

Purified patient-derived immunoglobulin G antibodies (Control- and anti-GABA_BR-IgG) were used in a mouse model of continuous 14-day cerebroventricular infusion via osmotic pumps. To investigate GABA_BR mediated regulation of synaptic transmission, somatic patch-clamp recordings of CA1 pyramidal neurons were performed and special stimulation protocols were applied on afferent fibers. To reveal IgG-effects on GABA_BR function, either the GABA_BR agonist baclofen or the antagonist CGP55845 was applied by bath perfusion. Memory and cognition was examined via novel object recognition (NOR) and novel object location (NOL) test.

Results:

GABA_BR antibodies affected excitatory synaptic transmission and short-term plasticity of heteroreceptors, as they reduced eEPSC amplitudes and the agonist effect of baclofen onto paired pulse ratios. Furthermore, they block presynaptic autoreceptors on inhibitory synapses, leading to less depression during repetitive IPSC stimulation. In contrast, postsynaptic GABA_BR-activated K⁺-currents and action potential firing is not influenced by patient's IgGs. Evaluation of cognitive function through behavioral paradigm suggests an influence of the anti-GABA_BR-IgG on the consolidation and maintenance of contextually precise memory, but not for the initial encoding of the memory.

Conclusions:

Our results provide evidence that GABA_BR antibodies antagonize the receptor preferably on presynaptic auto- and heteroreceptors, but have less direct pathogenic effect on postsynaptic GABA_BR-downstream signaling. These changes may contribute to severe neuronal dysfunction as the basis of memory dysfunction and increased seizure susceptibility.

Symposium

S25: A comparative perspective on social communication

[S25-1](#) Flexible contextual control over birdsong sequencing and structure
Lena Veit, Lucas Y Tian, Michael S Brainard

[S25-2](#) A comparative perspective on vocal production learning in bats
Mirjam Knörnschild

[S25-3](#) A tour through the brain of vocalizing bats
Julio C. Hechavarria

[S25-4](#) Audio-vocal Integration Mechanisms in Marmoset Monkeys
Julia Löschner, Thomas Pomberger, Steffen R. Hage

[S25-5](#) Neurobiology of cognitive vocal control in macaques and crows
Andreas Nieder

Flexible contextual control over birdsong sequencing and structure

Lena Veit¹, Lucas Y Tian², Michael S Brainard²

¹University of Tübingen, Neurobiology of Vocal Communication, Auf der Morgenstelle 28, 72076 Tübingen, Germany

²University of California, San Francisco and Howard Hughes Medical Institute

Bengalese finch (*Lonchura striata domestica*) song is a complex learned motor skill with variable sequencing of individual song elements, called syllables. Syllable sequencing or syllable structure can be gradually modified through reinforcement training, but it is unknown whether birds have flexible contextual control over their song production. We therefore tested whether adult Bengalese finches can flexibly and immediately switch between learned changes to their song in response to arbitrary, learned cues. At the level of song sequencing, we recently demonstrated that birds can rapidly modify the probability of specific syllable sequences (e.g. 'ab-c' versus 'ab-d') in response to colored light cues (Veit et al., 2021).

At a different level of the motor hierarchy, we tested whether syllable structure can likewise be modified in a context-dependent way. We paired opposite directions of pitch reinforcement for the same song syllable with different colors of cage illumination, e.g., reinforcing upward pitch shifts in orange light and downward pitch shifts in green light. After training birds on this protocol, light switches elicited immediate adaptive changes to syllable pitch consistent with the direction of reinforcement in each context. These changes were apparent in the first song bout after light switches, as well as in probe contexts without reinforcing feedback. These results indicate that Bengalese finches can learn to associate arbitrary contextual cues with specific changes to both the sequencing of syllables (Veit et al., 2021) and the structure (pitch) of individual syllables. However, the capacity for contextual control over song depends on the level of the motor hierarchy that is targeted, with large context-dependent changes to syllable sequencing and much more modest changes to pitch.

A comparative perspective on vocal production learning in bats

Mirjam Knörnschild¹

¹Museum for Natural History, Department of Evolutionary Diversity Dynamics, Invalidenstr. 43, 10115 Berlin, Germany

Bats comprise one of the few mammalian taxa capable of vocal production learning. The taxon's speciose nature makes bats well suited for comparative studies on proximate mechanisms of mammalian vocal production learning. In the first part of the talk, I will review the current state of knowledge on vocal production learning in bats from a comparative perspective. In the second part of the talk, I will highlight findings on vocal ontogenetic processes and vocal production learning in the greater sac-winged bat *Saccopteryx bilineata*. Pups of this species modify innate isolation calls based on auditory input from fellow pups in their social group and thus develop a group signature in isolation calls as they mature. Moreover, pups imitate male territorial song during ontogeny based on the auditory input they receive from singing males in their vicinity. Vocal imitation of pups commences during a conspicuous vocal behavior in which pups combine various elements from the adult vocal repertoire, including precursors of male territorial song, into long vocal sequences that can last for up to 40 minutes. These vocal sequences show a strong resemblance to the babbling bouts of human infants. Babbling is considered crucial for mastering the phonological challenges of speech acquisition in humans. Correspondingly, vocal production learning in *S. bilineata* takes place during the babbling phase, making this species highly interesting for comparative neuroethological studies on mammalian vocal production learning.

A tour through the brain of vocalizing bats

Julio C. Hechavarria¹

¹Goethe University, Frankfurt am Main, Auditory Computations lab, Department of Neurobiology , Max-von-Laue-Str. 13, 60438 Frankfurt am Main, Germany

Acoustic communication is of paramount importance for many animal species. Yet, at present, we know surprisingly little about what happens in the brain during vocalization. In this talk, I will show recent data indicating that vocalization networks are highly dynamic. This idea arises from experiments in which we recorded simultaneously from fronto-striatal and fronto-auditory cortex networks in vocalizing bats. I will argue that the directionality of information flow and the timing of inter-areal coherence depends on whether the bats are performing fast active listening (echolocation) or uttering social sounds. The data shows that rhythmic neural activity (oscillations) in frontal cortices and the striatum can predict whether bats are about to vocalize social or echolocation sounds. The frontal cortex renders the highest predictions, reaching accuracy > 80% when fast neural rhythms are considered, i.e., gamma oscillations with frequencies >30 Hz. At the network level, we observed strong fronto-striatal coherence that shifted depending on the timing and type of call uttered by the bats. When recording from the fronto-auditory cortex network we observed changes in information flow directionality, which depended on what and when the animals vocalized. I argue that feedback is prevalent in the frontal- auditory-cortex vocalization circuit, with information flowing predominantly from frontal to auditory areas (top-down) when animals are quiet, shortly before they vocalize, and after producing social calls. However, information flow does reverse selectively after echolocation, favoring the bottom-up direction (auditory to frontal). Taken together, these findings suggest a strong involvement of frontal areas in vocal control and the existence of dynamic fronto-striatal and cortico-cortical functional connectivity that can change with vocal behavior.

Audio-vocal Integration Mechanisms in Marmoset Monkeys

Julia Löschner, Thomas Pomberger^{1,3,4}, Steffen R. Hage^{1,2}

¹Neurobiology of Social Communication, Department of Otolaryngology – Head and Neck Surgery, Hearing Research Center, Medical Center University of Tübingen, Medical Center, Elfriede-Aulhorn-Str. 5, 72076 Tübingen, Germany

²Werner Reichardt Centre for Integrative Neuroscience, University of Tübingen, Otfried-Müller-Str. 25, 72076 Tübingen, Germany

³Graduate School of Neural & Behavioural Sciences - International Max Planck Research School, University of Tübingen, Österberg-Str. 3, 72074 Tübingen, Germany

⁴Present address: Neurobiology of Communication, Department of Neurobiology, Duke University School of Medicine, 311 Research Drive, Durham, NC 27710-4432

Any transmission of vocal signals faces the challenge of acoustic interferences such as heavy rain, wind, animal or urban sounds. Consequently, multiple strategies have evolved to compensate for masking noise during vocal behavior, leading to several changes in temporal and spectral call features. One prominent noise-related call adjustment is the Lombard effect, an involuntary increase in call amplitude in response to masking noise, which is often accompanied by changes in call duration and frequency. Another strategy involves limiting call production to periods where noise is absent. While control mechanisms underlying vocal adjustments as a direct response to ambient noise have been well studied, mechanisms underlying noise avoidance strategies remain largely unclear. Recent studies showed that marmoset monkeys exhibit vocal flexibility and are able to time their calls with respect to environmental noise. Using acoustic perturbation triggered by the vocal behavior itself we showed that marmosets are capable of rapidly modulating call amplitude and frequency in response to perturbing noise bursts presented after call onset. The strongest rise in call frequencies were found for high noise amplitudes. Surprisingly, phee calls did not exhibit the Lombard effect as previously reported for calls that were produced in constantly presented ambient noise. Instead, our monkeys decreased their call intensity with increasing noise intensity. Furthermore, we showed that marmoset monkeys are capable of producing calls with durations beyond the natural boundaries of their repertoire by interrupting ongoing vocalizations rapidly after perturbation onset. This finding suggests a general strategy of avoiding calling in a noisy environment in marmoset monkeys. Therefore, we systematically perturbed ongoing vocalizations with noise presented at different time points and detected changes in vocal behavior that supported both reflexive and adaptive behavior in response to noise perturbation. Marmosets canceled their calls immediately after noise onset with animals finding it easier to cancel calls towards the expected end of calls rather than at the beginning of the vocalization. These results suggest underlying neural mechanisms that might inhibit the interruption of vocalizations at the beginning of the pattern. The decrease in call duration started during the first perturbed call, indicating a reflexive behavior in response to noise perturbation. In contrast, the reduction in number of syllables persisted beyond noise perturbation, indicating adaptive behavior in response to perturbing noise. Using machine learning techniques based on call parameters, we found that a fraction of single phees uttered during and after noise perturbation were initially planned as double phees and became actively interrupted after the first syllable. Altogether, these findings indicate that marmosets use different parallel mechanisms how to cope with ambient noise. They show vocal adjustments as a direct response to perturbing noise, such as an involuntary increase in call amplitude and changes in call frequency. Additionally, they use noise avoidance strategies, i.e., suppressing vocalizations during periods of elevated ambient noise levels. Further neurophysiological studies will now have to investigate the mechanisms underlying the broad range of vocal adjustment capabilities.

Neurobiology of cognitive vocal control in macaques and crows

Andreas Nieder¹

¹University of Tübingen, Institute of Neurobiology, Auf der Morgenstelle 28, 72074 Tübingen, Germany

The vast majority of vertebrate species produce only innate vocalizations. Innate vocalizations occur spontaneously in species whenever they are exposed to certain affective stimuli and are closely controlled by hard-wired brain structures and their underlying genetic programs. However, in order to develop a flexible and deliberate vocal communicative system, such as human speech, volitional control of vocal utterances is a critical prerequisite. Whether non-human animals can cognitively control their vocalization, and how this may be represented in their brains, remained unclear. Psychophysical data from well-controlled behavioral tasks now demonstrate that both macaque monkeys and carrion crows can deliberately control their vocal output to decide when to initiate or suppress a vocalization. This argues that nonhuman primates and corvid songbirds can exert cognitive control over their vocalizations. During single-neuron recordings in these behaving animals, we found that neurons in the frontal cortex of monkeys and in the associative telencephalic area 'nidopallium caudolaterale' (NCL) of crows signaled the volitional preparation of the animals' vocal output. The activity of vocalization-correlated neurons predicted whether or not the animals would produce an instructed vocalization. Importantly, neuronal activity in preparation of volitional vocalizations differed from activity prior to spontaneous vocalizations. Therefore, neuronal activity was not just signaling the preparation of any vocal output, but the voluntary initiation of vocalizations specifically. This comparison of neurobiological results in nonhuman primates and corvid songbirds reveals convergent mechanisms of volitional vocal production in these different groups, despite their vast phylogenetic separation. These findings open useful avenues for gaining detailed mechanistic insight into how evolution endowed phylogenetically distant vertebrates with distinctly organized endbrain structures to control vocalizations.

Symposium

S26: Phase separation in neuronal (patho)physiology

- [S26-1](#) Single-molecule imaging studies of postsynaptic receptor turnover on the PSD protein condensates
Akihiro Kusumi
- [S26-3](#) The Enigmatic Spine Apparatus of Neuronal Dendritic Spines
Pietro Vittorio De Camilli, Hanieh Falahati, Yumei Wu, Vanessa Feuerer
- [S26-4](#) Single molecule imaging for investigating phase separation of synaptic vesicles in neurons
Jakob Rentsch, Christian Hoffmann, Taka Tsunoyama, Akshita Chhabra, Gerard Aguilar Perez, Franziska Trnka, Marcelo Ganzella, Gregory Giannone, Akihiro Kusumi, Helge Ewers, Dragomir Milovanovic
- [S26-5](#) TDP-43 condensates and lipid droplets regulate the reactivity of microglia and regeneration after traumatic brain injury
Jovica Ninkovic

Single-molecule imaging studies of postsynaptic receptor turnover on the PSD protein condensates

Akihiro Kusumi¹

¹Okinawa Institute of Science and Technology Graduate University (OIST), Membrane Cooperativity Unit, 1919 Tancha, 904-0495 Okinawa, Japan

Regulating the number and composition of AMPA receptors (AMPA receptors) in the synapse is one of the critical mechanisms for learning and memory. However, no agreement exists on AMPARs residency time (turnover rate) in the synapse, varied from <1 s to >10,000 s, nor on how the residency time is determined.

First, we addressed the problem of AMPARs residency time in the synapse by performing single-molecule imaging sensitive to 0.03-10,000 s. Synaptic (GluA2 and Stargazin) and non-synaptic (Thy1) molecules move in and out of the synaptic region, exchanging with those in the dendritic shaft. 5% of GluA2 molecules entering the synaptic region by diffusion in the plasma membrane become immobilized for >100-s order. For the GluA2 residency for 1,000-s order (maximal residency 3,000 s), its binding to PDZ proteins is required, whereas Stargazin might dynamically anchor AMPARs for <300 s. LTP increases the AMPARs' 1,000-s-order synaptic residency fraction, suggesting that the AMPAR's enhanced anchorage mechanism would be a key determinant for the AMPAR number in the synapse and thus enhanced synaptic strength after LTP.

Second, we addressed the mechanism for anchoring AMPARs and Stargazin as well as another synaptic receptor Neuroligin, a cell-cell adhesion molecule in the post-synapse. The mechanisms by which post-synaptic receptors and scaffold proteins are retained at the post-synapse are not well understood. We paid a special attention to the mechanism by which PSD95, a key scaffold protein, becomes concentrated in the post-synapse at the initial stages of excitatory synapse formation when the PSD95 concentrations would be low everywhere in the neuron's cytoplasm, including the places where synapses are later formed.

Here, we demonstrated that SynGAP forms phase-separated liquid-hydrogel condensates through homophilic interactions mediated by its C-terminal coiled-coil domain as well as its intrinsically disordered region, both in vitro ($\geq 2 \mu\text{M}$ with 1% polyethylene glycol=PEG) and in fibroblastic L cells ($\geq 0.3 \mu\text{M}$). SynGAP recruits PSD95 into these condensates by way of its PDZ-binding motif at its C-terminus, and not via the co-condensation via liquid-liquid phase separation. The full length PSD95 fails to form liquid condensates in vitro unless the concentrations were raised to $\geq 8 \mu\text{M}$ with 3% PEG. It fails to form condensates in L cells even at its highest expression level (5 μM).

PSD95 recruited to SynGAP condensates in turn recruited and immobilized receptors such as Neuroligin and AMPARs (via Stargazin). Meanwhile, in neurons, the number of Neuroligin's monomeric mutant in the synapse is about half of the number of wild-type Neuroligin. Further investigations revealed that oligomerization of Stargazin-AMPA complex and that of Neuroligin enhances the anchorage of these molecules in the SynGAP condensates containing PSD95, compared to monomeric Neuroligin and Stargazin.

Taken together, we conclude that the phase-separated SynGAP condensate formation might be the first

step for the excitatory synapse formation, which is then followed by PSD95 recruitment via SynGAP's PDZ-binding motif. Then, the third step would be the recruitment and retention of transmembrane receptors that can form oligomers, which are in equilibrium with their monomers. Our next goal is to reveal whether the PDZ proteins, including GRIP/ABP and PICK1, are recruited to SynGAP condensates, which might induce the long-term 1,000-s order anchorage of AMPARs.

The Enigmatic Spine Apparatus of Neuronal Dendritic Spines

Pietro Vittorio De Camilli¹, Hanieh Falahati¹, Yumei Wu¹, Vanessa Feuerer¹

¹HHMI; Departments of Neuroscience and Cell Biology; Program in Cellular Neuroscience, Neurodegeneration, and Repair, Yale University School of Medicine, New Haven, CT 06510

The spine apparatus is a specialized compartment of the neuronal smooth endoplasmic reticulum (ER) located in a subset of dendritic spines. It consists of stacks of ER cisterns that are interconnected by an unknown dense matrix and are continuous with each other and with the ER of the dendritic shaft. While this organelle has been first observed over 60 years ago, the mechanism of its formation and function remains a mystery. A main challenge in addressing these questions has been our lack of knowledge about its molecular components. To address this challenge, we performed in vivo proximity proteomics by using the only known spine apparatus specific protein, the actin binding protein synaptopodin, as a tool to target a biotinylating enzyme to this organelle. We validated the specific localization in dendritic spines of a small subset of proteins identified by this approach and we further showed their co-localization with synaptopodin when expressed in neuronal and non-neuronal cells. One such protein is Pdlim7, an actin binding protein not previously identified in spines. Pdlim7 interacts with synaptopodin through multiple domains and has an expression pattern similar to that of synaptopodin in the brain, highlighting a functional partnership between the two proteins. Strikingly, expression in non-neuronal cells of synaptopodin fused to an ER targeting module induces the formation of stacks of ER separated by a dense matrix with features resembling that of the spine apparatus. Collectively, these findings allow to formulate testable models about the structural organization and function of the spine apparatus. These include the hypothesis that synaptopodin may help bring together ER cisterns by assembling into condensates with actin and its other binding partners.

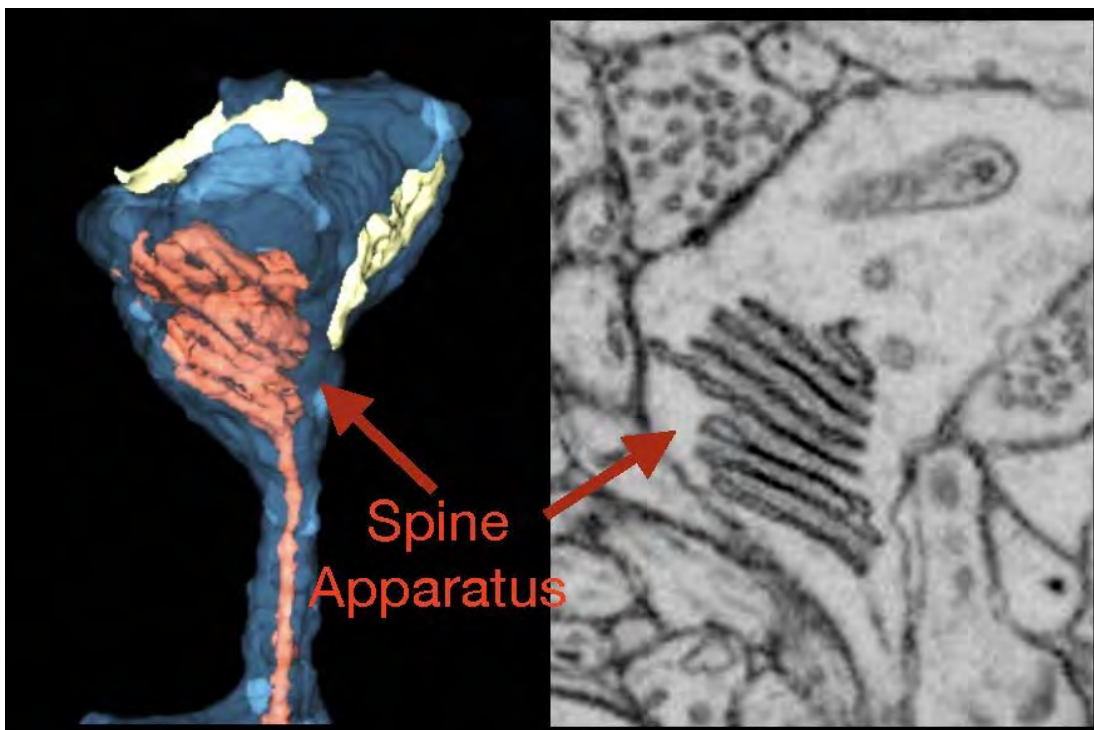

Spine Apparatus of Dendritic Spines

Single molecule imaging for investigating phase separation of synaptic vesicles in neurons

Jakob Rentsch, Christian Hoffmann², Taka Tsunoyama³, Akshita Chhabra², Gerard Aguilar Perez², Franziska Trnka², Marcelo Ganzella⁴, Gregory Giannone⁵, Akihiro Kusumi³, Helge Ewers¹, Dragomir Milovanovic²

¹Freie Universität Berlin

²Deutsches Zentrum für Neurodegenerative Erkrankungen

³Okinawa Institute of Science and Technology

⁴Max Planck Institute for Multidisciplinary Sciences

⁵Centre national de la recherche scientifique

Liquid-liquid phase separation (LLPS) is emerging as a mechanism that helps explain the mesoscale organization of synapses. For example, the reconstitution data and genetics both suggest that LLPS underlies the accumulation of synaptic vesicles (SVs). The cluster of SVs is critical for maintaining neuronal transmission. Despite being held together, SVs are highly mobile, so that they can be recruited to the plasma membrane for their rapid release during neuronal activity. The failure of SVs to accumulate at the synapse is linked to neurodegenerative and neuropsychiatric disorders. Despite the central importance of SV organization at the synapse, it remains challenging to scrutinize how such confinement of SVs corroborates with their motility. To bridge this gap, we employ single-molecule tracking (SMT) in living neurons to study the motility of synapsin and SVs. Our data suggest that synapsin is organized in two populations: the highly confined molecules at the synaptic boutons and the fast-diffusing molecules with directed motility between synapses. Additionally, in synapsin triple-knockout neurons, SVs were significantly more mobile and less confined than in wild-type neurons. We were able to fully rescue both the confinement and motility of SVs by expressing either full length synapsin 1 or its intrinsically-disordered fragment, known to be necessary and sufficient for LLPS of synapsin 1 in-vitro. While confined into a dense phase, synapsin 1 and SVs remain highly mobile, which is in line with them forming a biomolecular condensate. Interestingly, in addition to recovering the stereotypic diffusion pattern of SVs, the short intrinsically-disordered fragment of synapsin 1 was sufficient to rescue neurotransmitter release in synapsin triple-knockout neurons as measured by pH-sensitive fluorescent probes. Therefore, two-color single-molecule tracking in living axons demonstrates that synapsin 1 drives confinement and motility of SVs in synaptic boutons and that LLPS-synapsin 1 condensation is sufficient to maintain proper neurotransmission.

TDP-43 condensates and lipid droplets regulate the reactivity of microglia and regeneration after traumatic brain injury

Jovica Ninkovic¹

¹LMU München, Departement Anatomy and Cell Biology, Großhaderner Str. 9 82152 Planegg, 82152 Planegg, München, Germany

Decreasing the activation of pathology-activated microglia is crucial to prevent chronic inflammation and tissue scarring. In this study, we used a stab wound injury model in zebrafish and identified an injury-induced microglial state characterized by the accumulation of lipid droplets and TAR DNA-binding protein of 43 kDa (TDP-43)+ condensates. Granulin-mediated clearance of both lipid droplets and TDP-43+ condensates was necessary and sufficient to promote the return of microglia back to the basal state and achieve scarless regeneration. Moreover, in postmortem cortical brain tissues from patients with traumatic brain injury, the extent of microglial activation correlated with the accumulation of lipid droplets and TDP-43+ condensates. Together, our results reveal a mechanism required for restoring microglia to a nonactivated state after injury, which has potential for new therapeutic applications in humans.

Symposium

S27: From imprecision to robustness in neural circuit assembly

[S27-1](#) Robustness from noise: Temporal regulation of neural circuit development
Bassem Hassan

[S27-2](#) Inter-individual wiring variability and its function in the *Drosophila* olfactory pathway
Carlotta Martelli

[S27-3](#) Processing of navigational cues from the fly optic lobes towards the central complex
Mathias F. Wernet

[S27-4](#) A visual pathway with variable receptive field properties is a key constituent of robust motion computation
Marion Silies

[S27-5](#) Universality of modular correlated networks across the developing neocortex
Jonas Elpelt, Deyue Kong, Nathaniel James Powell, Bettina Hein, Haleigh Mulholland, Matthias Kaschube, Gordon Smith

Robustness from noise: Temporal regulation of neural circuit development

Bassem Hassan¹

¹Paris Brain Institute, Brain Development Laboratory, 47 Boulevard de l'Hopital, 75013 Paris, France

Individual variation in behaviour is a universal feature of animals but its origins in the brain are poorly understood. We investigate this question using the visual system of the fruit fly *Drosophila melanogaster* as model. Our goal is to understand if and how variation in the structure and function of neuronal circuits explains behavioural individuality.

Inter-individual wiring variability and its function in the *Drosophila* olfactory pathway

Carlotta Martelli¹

¹Johannes Gutenberg University Mainz, Institute for developmental and neurobiology, Hanns-Dieter-Hüsch-Weg 15 , 55128 Mainz, Germany

Many sensory stimuli can drive innate behavioral responses that are to some degree hard-wired in neural circuits by genetically controlled developmental programs. This is the case for the well-studied *Drosophila* olfactory pathway, where development results in the formation of a stereotypic neural map that constitutes the basis for olfactory perception. However, even in such model system, development is not fully deterministic, and it relies on stochastic processes that can be affected by environmental factors. Here we investigate the degree of variation in wiring across genetically identical individuals by using transsynaptic tracing methods to quantify connectivity of second and third order neurons in the olfactory pathway. We show that inter-individual variability is not uniform across cell types and it depends on developmental temperature. Finally , we bring together computational models and *in vivo* calcium imaging to investigate the functional consequences of wiring variability for olfactory perception to ultimately understand how it supports robustness at the individual or population level.

Processing of navigational cues from the fly optic lobes towards the central complex

Mathias F. Wernet¹

¹Freie Universität Berlin, Neurobiologie, Königin-Luise Strasse 1-3, 14195 Berlin, Germany

Many animals rely on a combination of different visual cues for navigation, like landmarks, intensity gradients, color gradients, or the pattern of skylight polarization. The most important pathway for mediating these behaviors across insect species, including *Drosophila melanogaster*, is formed by the Anterior Visual Pathway (AVP), linking the adult eye to the central complex, via a visual glomerulus – the anterior optic tubercle (AOTU). Although much is known about how navigational decisions informed in the central complex, via the activity of ring neurons (R neurons) and head-direction-like cells (EPG neurons), large gaps remain in our understanding of the fine-scale synaptic connections within the AVP, and how these might relate to the processing of specific visual cues.

We have used a connectomic resource (FlyWire), to reconstruct all major neurons in the AVP, based on an electron microscopic dataset spanning an entire adult female fly brain (FAFB). We use different methods to group the identified neuron types into distinct classes with differing upstream and/or downstream connectivity. This reveals how different R neurons receive different forms of visual information, while also covering different parts of the visual world.

Photoreceptors in the so-called dorsal rim area (DRA) of the adult eye, specialized for detecting polarized skylight, together with their downstream circuitry, are an excellent model system for understanding one specific branch of the AOTU in more detail. We use a combination of anatomical, physiological, behavioral, and developmental approaches to understand how retinotopic information about the angle of polarization (AoP) in the sky is processed along the AVP. Here we focus on the development and function of two similar types of visual projection neurons connecting the DRA-region of the medulla neuropil to the AOTU. Although morphologically very similar, our characterization reveals that these two cell types process the same navigational cue (skylight information) very differently, hence providing different types of output into the AVP, ultimately informing different R neuron types.

A visual pathway with variable receptive field properties is a key constituent of robust motion computation

Marion Silies¹

¹Johannes Gutenberg University Mainz, Institute of Developmental Biology and Neurobiology, Hanns-Dieter-Hüsch Weg 15, 55128 Mainz, Germany

Many visually guided animals rely on the processing of motion cues to chase their prey, escape predators, and to simply navigate the world. Therefore, the computation of motion cues must be robust to any changes and perturbations that the animal encounters. This can include internal changes, such as different behavioral states, as well external challenges, such as sudden changes in the visual environment. The computation of motion is considered to be achieved by highly stereotypic visual circuits that repeat over the 800 units of the fly eye. Here, I will discuss how a neuron with variable receptive field properties is a key constituent of robust motion computation, suggesting that variability in neural circuitry underlies behavioral robustness. In *Drosophila*, direction-selective neurons implement a mechanism of motion computation that relies on contrast-opponent receptive fields with ON and OFF subfields. The biological substrate for this contrast opponency in the OFF pathway is made up by a set of interneurons, Tm2, Tm9 and CT1, that also provide information about ON stimuli to the downstream OFF direction-selective neuron T5 across its receptive field. One of those interneurons, Tm9, which has a prominent role in motion detection, displays variability in its receptive field properties that transfer to T5. At the same time, several Tm9 physiological properties, such as contrast-opponent calcium signals to visual stimuli, persist across behavioral states. This work shows how a key neuronal computation is implemented by its constituent neuronal circuit elements to ensure direction selectivity and argues that variability is a key feature of robust motion computation.

Universality of modular correlated networks across the developing neocortex

Jonas Elpelt, Deyue Kong¹, Nathaniel James Powell², Bettina Hein³, Haleigh Mulholland²,
Matthias Kaschube¹, Gordon Smith²

¹Frankfurt Institute for Advanced Studies & Department of Computer Science and Mathematics, Goethe University, Frankfurt am Main, Germany

²Medical Discovery Team for Optical Imaging, Department of Neuroscience, University of Minnesota, Minneapolis, MN, USA

³Center for Theoretical Neuroscience, Columbia University, New York, NY, USA

In order to deal with a complex environment, animals form a diverse range of neural representations that vary across cortical areas, ranging from unimodal sensory input to higher-order representations of goals, outcomes and motivation. The diversity of these representations suggests a high degree of specialization in functional organization across cortical areas, however, the developmental origin of this diversity remains unclear. Diverse representations may be rooted in an area-specific functional organization established early in development by endogenous mechanisms. Alternatively, a common representational architecture may exist across the early neocortex, established by common rules of dynamic network interactions, while functional specification arises primarily through area-specific inputs.

Here we address this fundamental question by examining spontaneous activity across the developing ferret cortex. We show that spontaneous activity in both sensory (visual—V1, auditory—A1, and somatosensory—S1) and association cortices (posterior parietal—PPC and prefrontal—PFC) is highly modular and exhibits millimeter scale correlations. Across all areas in animals 7-10 days prior to eye opening, modular patterns of spontaneous activity were nearly indistinguishable from those seen previously in V1, which reflect the columnar representation of visual features. Over the subsequent 3 weeks, a period spanning both eye opening and ear canal opening, we find that while both the degree of modularity and the strength of long-range correlations decline with age, all cortical areas retained significant modular structure. In all areas examined, spontaneous activity became increasingly sparse and higher dimensional over this period, suggesting an improved representational capacity with increasing maturity. Furthermore, similar to published reports in V1, sensory evoked activity in A1 exhibits strongly modular responses with significant statistical similarity to spontaneous activity, suggesting that early spontaneous networks seed developing cortical representations in sensory areas and raising the possibility of a similar relationship in higher association areas such as PFC. Together, our results demonstrate that modular networks with long-range correlations in spontaneous activity are not unique to columnar V1, but rather are a universal feature during development. These findings suggest that the diverse representations found across neocortex may arise from a common developmental origin.

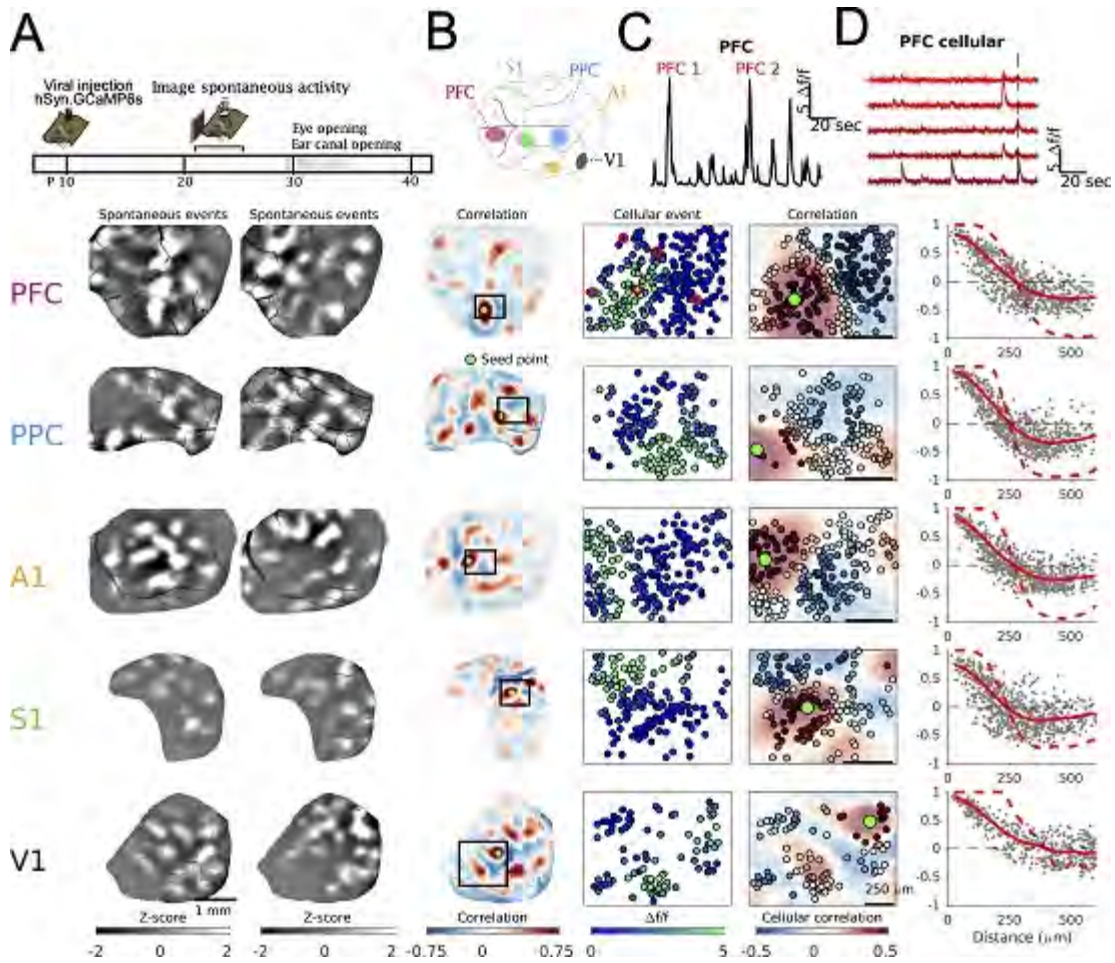

Symposium

S28: Translational science in pediatric neurology – what we can learn!

- [S28-1](#) Molecular Neuroscience in Neuropaediatrics - from Intervention to Screening
Katharina Vill, Heike Kölbl, Oliver Schwartz, Astrid Blaschek, Ulrike Schara, Wolfgang Müller-Felber
- [S28-2](#) Genetic mechanisms involved in hydrocephalus formation
Julia Wallmeier
- [S28-3](#) Repurposing FDA approved drugs for maternally inherited Leigh syndrome using human iPSC derived disease models.
Markus Schuelke
- S3-4 Retracted
- [S28-4](#) Extraembryonic source of Serotonin involved in Neurodevelopment
Niccolò Milani, Laura Boreggio

Molecular Neuroscience in Neuropaediatrics - from Intervention to Screening

Katharina Vill¹, Heike Kölbel², Oliver Schwartz³, Astrid Blaschek¹, Ulrike Schara²,
Wolfgang Müller-Felber¹

¹LMU, Dr. v. Haunersches Kinderspital, Department of Neuropediatrics, Lindwurmstr. 4, 80809 Munich, Germany

²University of Essen, Department of Neuropediatrics, Hufelandstr. 55, 45147 Essen

³University of Muenster, Albert-Schweitzer-Campus 1, 48149 Münster

Spinal muscular atrophy is an autosomal recessive neurodegenerative disorder characterized by the loss of spinal motoneurons leading to muscle weakness and atrophy. It is caused by deficiency of survival motoneuron protein (SMN) resulting from biallelic loss of the *SMN1* gene. The paralogous *SMN2* gene modulates the SMA phenotype, most crucially through its variable gene copy number. However, not all *SMN2* gene copies are equivalent in terms of their function in SMN protein delivery. Several *SMN2* variants have been identified that are associated with milder phenotypes. Less is known about *SMN2* variants that lead to more severe SMA phenotypes or whether certain *SMN2* variants are associated with a poorer response to mRNA therapies.

SMN-targeted therapies increase the level of SMN protein: the mRNA therapies nusinersen and risdiplam increase the amount of functional protein derived from *SMN2* transcription, while the gene transfer therapy onasemnogene abeparvovec xioi increases SMN protein by implementation of the human *SMN1* gene into cells via an adeno-associated viral vector (AAV9). All three molecular therapies have been shown to be effective in improving treatment outcomes and are approved in the U.S. and EU for the treatment of SMA. Superiority of one of the therapies over another has not been demonstrated. Because the most critical difference in the efficacy of the SMA therapies is the timing of application, which ideally should be pre-symptomatic, SMA has been implemented into the statutory newborn screening in Germany in October 2021. The transition from the pilots can be considered well accomplished, and after initial isolated false positive results and secondary optimization of the method, sensitivity, specificity, and post-diagnosis course are now largely within the range of the pilot projects in which more than 500,000 children were screened. Although the observation period among molecular therapies is still comparatively short so far, screening suggests a decisive impact on the overall prognosis of all SMA patients who have immediate access to the novel drug therapies. Nevertheless, in a proportion of patients, particularly those with few *SMN2* copies, the disease process has already started at the time of birth. In the absence of long-term data, there is still uncertainty regarding the indication for treatment for patients with higher copy numbers, but initial clinical data suggest that early initiation of treatment is reasonable as well for those patients.

The peculiarities of SMA genetics with, on the one hand, a rather small "main gene", which is therefore a candidate for virus vector-associated therapeutic approaches, and, on the other hand, a paralogous gene, which is the target for alternative splicing, e.g. by means of antisense oligonucleotide, makes SMA a pioneering model for the therapy of other genetic diseases.

This also relates to the need for genetic screening. Neurodegenerative diseases in particular need to be detected at an early stage so that patients can benefit from the efficacy of new molecular therapies. Given the increasing number of treatable diseases, all with completely different underlying biomechanisms, broader genetic screening approaches seem to be a possible way into the future.

Genetic mechanisms involved in hydrocephalus formation

Julia Wallmeier¹

¹University Clinic Münster, General Pediatrics, Albert Schweitzer Campus 1, 48149 Münster, Germany

Hydrocephalus is a common finding in newborns. In most cases, it is caused by intraventricular hemorrhage associated with prematurity, whereas in some patients the cause of hydrocephalus can be traced back to genetic changes. These pathogenic variants can be associated with a clinically heterogenous spectrum of disease syndromes such as RASopathies, lysosomal storage diseases, dystroglycanopathies, craniosynostosis and ciliopathies. Overall the majority of genes related to hydrocephalus formation play a crucial role in the process of cortical development.

Repurposing FDA approved drugs for maternally inherited Leigh syndrome using human iPSC derived disease models.

Markus Schuelke¹

¹Charité - Universitätsmedizin Berlin, Neuropediatrics, Augustenburger Platz 1, 13353 Berlin, Germany

Drug repurposing, e.g. using FDA and EMA approved drugs for novel disease indications has become an important field of research and of translational neurology especially in the field of rare (genetic) orphan diseases. A cell model that reliably mirrors the pathology of the disease is a prerequisite for such a substance screening. Often these disease models can be obtained by differentiation iPSC into the desired tissue of interest (e.g., myocytes, neuronal or glial cells). Secondly, we need a readout test that shows on the cellular level whether the pathologic process can be overcome by a specific substance. These assays are preferably optic readouts that can be assessed by high-throughput automated microscopy. Here we present a use case for the repurposing of PDE5 inhibitors as a treatment for maternally inherited Leigh-syndrome due to mutations in the MT-ATP6 gene.

Extraembryonic source of Serotonin involved in Neurodevelopment

Niccolò Milani, Laura Boreggio^{1,2}

¹Max Delbrück Center for molecular medicine (MDC), Michael Bader Lab - Molecular Biology of Peptide Hormones, Robert-Rössle-Straße 10, 13125, Berlin, Germany.

²The Serotonin & Beyond project, European Union's Horizon 2020 research and innovation programme, No. 953327.

Studies in recent years have suggested that maternal and extraembryonic sources of serotonin, such as placenta, play pivotal roles in embryonic brain development. However, the identity of serotonergic system components and cell types expressing serotonergic genes during development, as well as mechanisms of serotonin transport to the embryo remain controversial (Bonnin et al., *Nature*. 2011; 472(7343):347-50; Kliman et al., *Endocrinology*. 2018;159(4):1609-1629).

The aim of this project is to evaluate the contribution of extraembryonic sources of serotonin to PFC development and to dissect the involved cellular and molecular components. Since such an approach is not possible in humans, we use mouse models deficient in genes encoding the serotonin synthesizing enzymes, TPH1 (Walther et al. *Science* 2003;299:76) and TPH2 (Alenina et al. *Proc Natl Acad Sci USA* 2009;106:10332-7), and the monoamine transporters, SERT and OCT3, to clarify if these proteins contribute to the supplementation of the fetus with serotonin in the absence of own serotonin production and what is their role in brain development. We investigate the effect of maternal and placental SERT, OCT3, TPH1 and TPH2 depletion on the serotonin levels in placenta and different parts of the embryonic brain before the onset of Tph2 expression at embryonic day (E) 10-11; after the birth of serotonergic neurons (E12-14) and upon serotonergic innervation of the forebrain (E15-16) and on serotonergic-innervation pattern at later stages of embryogenesis.

For this purpose, this project takes advantage of available animal models, including double and triple knockouts for genes involved in serotonin synthesis and transport. We use breeding strategies and embryo transfer technology to create mothers and fetuses with different genotypes. Furthermore, we use tetraploid aggregation (Popova et al. *Hum Reprod* 2011;26:662-70) to segregate the effects of serotonin production from extraembryonic tissues and the embryo itself. The serotonin content in the placental and embryonic material are measured by LC-MS and HPLC and visualized by immunohistochemistry. PFC maturation and serotonergic wiring in different mutants are assessed by an adjusted version of the 3D whole-mount brain imaging technique iDisco+.

Symposium

S29: Brain dysfunction upon energy failure: new insights into the role of astrocytes

- [S29-1](#) Synaptic and perisynaptic glutamate signaling during the onset of metabolic stress
Stefan Passlick, Vladimir Zavalov, Jessica Abigail Feria-Pliego, Petr Unichenko, Nariman Kiani, Christian Henneberger
- [S29-2](#) SF-iGluSnFR imaging reveals “plume-like” glutamate events during chemical ischemia in mouse cortical brain slices
Tim Ziebarth, Andreas Reiner
- [S29-3](#) Biophysical modelling of ion dynamics at the energy-deprived tripartite synapse
Hil Gaétan Ellart Meijer, Manu Kalia, Christine Rose, Michel van Putten
- [S29-4](#) Rapid changes of astrocytic gap junctional coupling during energy deprivation
Sara Eitelmann, Katharina Everaerts, Laura Petersilie, Christine Rosemarie Rose, Jonathan Stephan
- [S29-5](#) Neurotoxic astrocyte swelling and dysfunction upon the acute phase of ischemic stroke
Ákos Menyhárt, Rita Frank, Ferenc Bari, Eszter Farkas

Synaptic and perisynaptic glutamate signaling during the onset of metabolic stress

Stefan Passlick¹, Vladimir Zavalov¹, Jessica Abigail Feria-Pliego¹, Petr Unichenko¹,
Nariman Kiani¹, Christian Henneberger^{1,2}

¹Institute of Cellular Neurosciences, University of Bonn, Germany

²German Center for Neurodegenerative Diseases (DZNE), Bonn, Germany

Ischemic stroke is a severe form of metabolic stress and malfunction of glutamate homeostasis has been identified as a central step in its pathophysiology. Neurons as well as astrocytes have vital functions during synaptic transmission which can be affected during metabolic stress. For instance, the lack of energy causes a breakdown of ion gradients, which is thought to promote the accumulation and spread of glutamate in the extrasynaptic space leading to overactivation of N-methyl-D-aspartate receptors (NMDARs) and irreversible excitotoxic damage. The latter has been investigated by many studies, but the sequence of events and specific mechanisms leading to perturbed glutamate signaling remain largely unclear.

Here, we combined electrophysiology and pharmacological manipulation with two-photon excitation imaging of synaptic glutamate release and Ca^{2+} signaling to study the effect of moderate and strong metabolic stress on glutamate homeostasis in acute hippocampal slices. Our experiments showed that strong metabolic stress resulted in a persistent failure of synaptic transmission, whereas moderate stress led to a transient failure, followed by a potentiation of synaptic transmission, a phenomenon known as ischemic long-term potentiation (iLTP). Simultaneous recordings of the extracellular K^+ concentration revealed that moderate stress was associated with small $[\text{K}^+]$ transients whereas strong stress was accompanied by large increases in extracellular $[\text{K}^+]$. Likewise, monitoring of extracellular glutamate levels or astrocytic Ca^{2+} transients showed that long periods of metabolic stress induced a transient strong surge of extracellular glutamate and a prolonged increase in somatic $[\text{Ca}^{2+}]$, whereas short periods did not alter resting glutamate levels or astrocytic Ca^{2+} transients. Unexpectedly, we observed that iLTP was accompanied by a persistent increase in extracellular glutamate transients evoked by synaptic stimulation. Further experiments revealed that the increased glutamate transients were not due to changes of synaptic paired-pulse behavior or glutamate uptake. Also, iLTP after moderate stress was sensitive to NMDAR inhibition whereas imaging of the NMDAR co-agonists glycine and D-serine detected increases in both in response to strong metabolic stress.

Current experiments aim at understanding the mechanisms leading to increased synaptic glutamate transients after brief episodes of metabolic stress.

SF-iGluSnFR imaging reveals “plume-like” glutamate events during chemical ischemia in mouse cortical brain slices

Tim Ziebarth, Andreas Reiner¹

¹Ruhr-Universität Bochum, AG Zelluläre Neurobiologie, Universitätsstraße 150, 44801 Bochum, Germany

Glutamate release and uptake is tightly regulated under physiological conditions. During metabolic stress, such as ischemic stroke, this homeostasis might become disrupted: Energy deprivation causes neuron and astrocyte depolarization, which may enhance glutamate release. At the same time, glutamate uptake by glial cells becomes impaired. Accumulation of glutamate in the extracellular space may then create a feed-forward loop by perpetuating depolarization and thereby increasing energy consumption.

To investigate these changes in extracellular glutamate dynamics during metabolic stress in real time, we expressed SF-iGluSnFR [1], a green-fluorescent glutamate sensor, in organotypic cortico-hippocampal brain slices from mice. Synapsin-driven SF-iGluSnFR was expressed by AAV transduction and brief chemical ischemia [2] was evoked by withdrawing glucose and by adding azide and 2-deoxyglucose to inhibit ATP synthesis and glycolysis, respectively.

We find that under baseline conditions wide-field imaging of SF-iGluSnFR reports on synchronous spontaneous activity, similar to GCaMP6f. Moreover, we observed uncorrelated glutamate events with “plume-like” characteristics. These “plume-like” events are quite heterogenous, have a large roundish appearance (mean diameter 17.5 μm) and remain locally confined. They have fast rise times and an average duration of 322 ms, which is considerably longer than glutamate signals associated with spontaneous activity (169 ms duration). Their frequency under baseline conditions is rather low. Upon inducing chemical ischemia, spontaneous activity ceases and extracellular glutamate accumulates across large regions of the cortex. This transient accumulation seems to be mainly driven by “plume-like” events, which become 1.5-fold increased in size, two-fold longer, and occur at a ten times higher frequency. Glutamate plumes persist in the presence of TTX, which blocks normal neuronal activity, and they become more abundant upon inhibition of glutamate uptake with TBOA. This work shows that extracellular glutamate accumulation during pathologic conditions might be driven by local, “plume-like” events. Similar events were recently also observed in a mouse migraine model [3]. The exact nature and mechanism of these events remains to be elucidated.

[1] Marvin et al., Nat. Methods (2018) 15: 135-143

[2] Lerchundi et al., J. Neurosci. Res. (2019) 97: 933-945

[3] Parker et al., Neuron (2021) 109: 611-628

Biophysical modelling of ion dynamics at the energy-deprived tripartite synapse

Hil Gaétan Ellart Meijer¹, Manu Kalia¹, Christine Rose², Michel van Putten³

¹University of Twente, Applied Mathematics, PO Box 217, 7500 AE Enschede, Netherlands

²Institute of Neurobiology, Heinrich Heine University Düsseldorf, Universitätsstraße 1, D-40225 Düsseldorf, Germany

³University of Twente, Clinical Neurophysiology, PO Box 217, 7500 AE Enschede, Netherlands

Ion homeostasis at the tripartite synapse is essential for synaptic transmission. Using a computational model, we study how this balance is disturbed upon energy deprivation. The model describes a presynaptic neuron and an astrocyte and includes active and passive transport for sodium, potassium, chloride, calcium and glutamate. We calibrated our biophysical model using experimental data.

We first show that by blocking the function of the sodium-potassium-ATPase (NKA) in the model, ion gradients break down, and cell swelling follows, confirming the critical role of the NKA. Our simulations also reveal a tipping point where the neuronal state transits from a physiological state to a pathological, depolarized state. This transition is more likely in our model if the extracellular space volume is small.

Next, we look at glutamate levels during energy deprivation. Recent data show that specific experimental conditions and astrocytic EAAT deficiencies affect glutamate clearance from the synaptic cleft. We mimic these situations in our model and discuss the consequences for the concentrations of other ions.

Rapid changes of astrocytic gap junctional coupling during energy deprivation

Sara Eitelmann¹, Katharina Everaerts¹, Laura Petersilie¹, Christine Rosemarie Rose^{1,2},
Jonathan Stephan^{1,2}

¹Heinrich Heine University Duesseldorf, Institute of Neurobiology, Universitaetsstr. 1, 40225 Duesseldorf, Germany

²These authors contributed equally.

Brain function is dependent on the proper regulation of ion homeostasis. Hereby, gap junctional coupling between astrocytes plays a key role. Gap junctions functionally couple adjacent astrocytes, leading to the formation of extensive syncytia and allowing the intercellular distribution of ions. Differences in ion concentration and thus membrane potential are equalized within those syncytia establishing a so-called “syncytial isopotentiality” (Ma et al., 2016). Importantly, gap junction mediated coupling of astrocytes is not static. Several factors can dynamically modulate gap junction permeability including altered neuronal activity or strong changes in intracellular concentrations of H⁺ and Ca²⁺.

Brain ischemia is accompanied by spreading depolarizations (SDs). These depolarizing waves originate in the energy deprived ischemic core and subsequently spread into the penumbra, the transition area between irreversible damage and healthy tissue. SDs are characterized by a transient breakdown of ion homeostasis, suggesting that astrocyte gap junctional coupling might be affected as well. In her talk, Sara Eitelmann will present experiments analyzing changes in gap junctional coupling of astrocytes in acute tissue slices of layer II/III of the somatosensory cortex to address this question. Transient energy failure in the ischemic penumbra was mimicked by perfusing slice preparations with glucose-free aCSF containing sodium azide and the glucose analog 2-desoxyglucose (“chemical ischemia”). The syncytial isopotentiality of astrocytes was recorded by whole-cell patch-clamp, enabling the dynamic monitoring of astrocytic coupling strength. Moreover, alterations of intracellular Na⁺, pH and Ca²⁺ concentrations were analyzed using wide field imaging with ion-sensitive dyes.

Her results show that transient chemical ischemia for 2 minutes caused a membrane depolarization and a rapid, partial uncoupling of astrocytes. This was accompanied by a reduction in the diffusive spread of Na⁺ in the astrocytic syncytium. Cluster analysis revealed the existence of two cell populations differing in the degree of ischemia-induced uncoupling as well as in their ability to regain gap junction permeability. Astrocytes of the first cluster (about half of the recorded cells) showed a reduction in coupling strength to about 81% of control. Moreover, their membrane potentials nearly fully recovered towards baseline within a few minutes after washout of the blockers. Astrocytes of the second cluster, in contrast, experienced a loss of coupling strength to 13% of control and remained depolarized for the entire recording period. While the chemical ischemia-induced uncoupling was independent of intracellular acidification, it could be rescued by either removal of extracellular Ca²⁺ or blocking Ca²⁺ influx via transporters and channels.

Our data thus demonstrate a heterogeneity in the astrocytes’ response to metabolic inhibition. They also show that metabolic inhibition can result in a rapid and dynamic uncoupling of neocortical astrocytes. The latter might aggravate breakdown of ion homeostasis in the ischemic penumbra during transient SDs.

Supported by DFG (FOR 2795 “Synapses under stress”: Ro2327/13-2).

Neurotoxic astrocyte swelling and dysfunction upon the acute phase of ischemic stroke

Ákos Menyhárt^{1,2}, Rita Frank^{1,2}, Ferenc Bari³, Eszter Farkas^{1,2}

¹University of Szeged, Department of Cellular Biology and Molecular Medicine, Somogyi u. 4., 6720 Szeged, Hungary

²HCEMM-USZ Group of Cerebral Blood Flow and Metabolism, Somogyi u. 4., 6720 Szeged, Hungary

³Department of Medical Physics and Informatics, Albert Szent-Györgyi School of Medicine and Faculty of Science and Informatics, University of Szeged, Szeged, Hungary

Cerebral edema is a key prognosticator of unfavorable outcome in acute ischemic, hemorrhagic, or traumatic brain injury. In the acute phase of cerebral edema, astrocytes show high permeability to water, because astrocytes are endowed with aquaporin-4 (AQP-4) channels, which conduct osmotically driven water. We demonstrate in rodents that acute brain swelling upon cerebral ischemia impairs astrocyte glutamate clearance and predisposes the injured tissue to the occurrence of secondary pathological events, spreading depolarizations (SD). In anesthetized rats, the evolution of SD is fostered by the cytotoxic extracellular **glutamate accumulation** (>15 μM), against which swollen astrocytes are completely impotent. We confirm in rat brain slices exposed to osmotic stress that astrocyte swelling is the key mechanism behind SD occurrence, oncotic neuron death and lesion progression. In line with this, the specific blockade of astrocytic AQP-4 channels, Na⁺/K⁺/Cl⁻ co-transporters, or volume-regulated anion channels mitigated cellular-and tissue swelling, extracellular **glutamate accumulation** (<10 μM) and SD occurrence. Also, the complete reversal of slice swelling by hyperosmotic mannitol solution counteracted glutamate accumulation and attenuated SD. In contrast, selective glial poisoning, or the inhibition of astrocyte glutamate transporters (EAAT-1) reproduced the occurrence of SD. Finally, we show in the mouse water intoxication model of cytotoxic edema that astrocyte swelling is associated with altered astrocyte calcium waves that co-exist with SD evolution. Our results emphasize the need of preventive osmotherapy in the treatment of acute ischemic brain injury.

Symposium

S30: Alternatives to living animal models

[S30-1](#) From animal studies to *in vitro* models: Prospects of directly converted and forward programmed human neural cell types

Lea Jessica Berg, Tamara Krutenko, Jianbin Wen, Christina Au Yeung, Pascal Röderer, Luzia Heidrich, Natalia Garcia Perez, Michael Peitz, Oliver Brüstle

S30-2 Retracted

[S30-3](#) Filamented Light (FLight) projection for the rapid fabrication of nerve grafts

Parth Chansoria, Marcy Zenobi-Wong

[S30-4](#) Using computer models to understand pathological bursts in neuronal cultures

Johannes Zierenberg, Viola Priesemann

[S30-5](#) A Network Model for Two-dimensional Hippocampal Theta Sequences of Extrinsic and Intrinsic Natures

Yuk Hoi Yiu, Christian Leibold

From animal studies to *in vitro* models: Prospects of directly converted and forward programmed human neural cell types

Lea Jessica Berg¹, Tamara Krutenko¹, Jianbin Wen¹, Christina Au Yeung¹, Pascal Röderer¹, Luzia Heidrich^{1,2}, Natalia Garcia Perez¹, Michael Peitz^{1,3}, Oliver Brüstle^{1,2}

¹Institute of Reconstructive Neurobiology, University of Bonn Medical Faculty and University Hospital Bonn, Venusberg-Campus 1, 53127 Bonn, Germany

²LIFE & BRAIN GmbH, Venusberg-Campus 1, 53127 Bonn, Germany

³Cell Programming Core Facility, University of Bonn Medical Faculty, Venusberg-Campus 1, 53127 Bonn, Germany

While animal experimentation remains essential for studying disease pathogenesis and developing therapies at an organismal level, it also comes with significant limitations due to species-specific differences. At the same time, *in vitro* systems based on human cells and tissues have for a long time been largely inaccessible. This is particularly true for tissues with limited regenerative potential such as the nervous system. The advent of human pluripotent stem cells (hPSCs) and the ability to program cells into distinct fates using forced expression of transcription factors are about to overcome both limitations. This presentation will highlight recent advances in programming neural stem cells (NSCs) directly from peripheral blood and discuss 'forward programming' approaches for generating distinct neuronal subpopulations from hPSCs. Specifically, we demonstrate how forward programmed human central and peripheral neurons can be used to facilitate disease modeling *in vitro*. Using exemplars such as neurodevelopmental SYNGAP1 syndrome, FIP200-associated psychiatric disease and the pain disorder inherited erythromelalgia, we illustrate that forward programmed neurons provide access to *in vitro* pathophenotypes that can be used to disentangle disease mechanisms and to probe therapeutic compounds. Furthermore, we demonstrate that the direct conversion of peripheral blood cells into induced NSCs (iNSCs) is associated with protracted epigenetic de-aging, a process that is difficult to address in short lived laboratory animals but may provide novel prospects for the generation of donor cells for neurotransplantation.

Filamented Light (FLight) projection for the rapid fabrication of nerve grafts

Parth Chansoria¹, Marcy Zenobi-Wong¹

¹ETH Zurich, Tissue Engineering and Biofabrication, HPL D16.2, 8093 Zurich, Switzerland

Traumatic and non-traumatic forms of nerve injuries present a widespread clinical problem. Examples range from compression injuries of the nerves to large gap injuries where a significant portion of the nerve stump is damaged. These defects are associated with neuropathic pain, and partial or complete loss of sensory, motor, and autonomic functions. For large defects, autologous nerve grafting is the current gold standard, with inevitable donor site morbidity, and limited size and modality. A preferentially oriented alignment (anisotropy) and fascicular (bundled-up) structure of the nerve tissue are critical for a healthy physiological function. Abnormal nerve regeneration and associated patho-physiology are often attributed to desolated directional cues within the severed nerve. Despite tremendous progress in the development of nerve grafts for axonal growth and guidance, there are still several unmet challenges: 1) lack of a 3D biomimetic framework (i.e., alignment is only prevalent on the surface); 2) un-controlled bio-resorption, eventually effecting the neo-tissue remodelling; 3) inadequate structural properties (porosity), which limits the neuronal infiltration and outgrowth and 4) time-consuming fabrication process, which limits the cost effectiveness and scalability of the grafts. Within this context, we have developed and patented a new biofabrication technology which uses filamented light (FLight biofabrication) within biocompatible and biodegradable photoresins for the rapid fabrication of anisotropic centimeter-scale hydrogel grafts. Using FLight, can fabricate grafts upto 5 cm in length and 1 cm in diameter in less than 30 s. Our pilot data demonstrates striking similarities between the micro-architecture of acellular grafts and fascicular arrangement of axons within the nerves. The hydrogel grafts feature longitudinal microfilaments along fascicles. The diameter of the microfilaments is tunable between 5 to 30 μm by changing the spatial coherence of the light projections, and each microfilament is prevalent across the entire length of the graft. We demonstrate that the microvoids between the microfilaments are excellent micro-conduits for the linear organization and growth of neurons (dorsal root ganglions) inside and through the 3D construct. Ongoing work is investigating whether the neurons can proliferate throughout the entire length of the grafts, which will be followed-up with in vivo models of peripheral nerve injury repair. Our technology represents a significant advance towards reducing the cost and increasing the effectiveness of nerve grafts for peripheral nerve injury repair.

Using computer models to understand pathological bursts in neuronal cultures

Johannes Zierenberg¹, Viola Priesemann¹

¹Max Planck Institute for Dynamics and Self-Organization, Am Fassberg 17, 37077 Göttingen, Germany

An alternative to living animal models are neuronal cultures. However, these cultures typically develop pathological bursts. We developed an a priori understanding of the origin of these bursts, showing that the isolation of the in vitro system, together with homeostatic plasticity may be causal for the bursts, and propose clear experiments that enable us to circumvent such pathological behavior in neuronal cultures.

A Network Model for Two-dimensional Hippocampal Theta Sequences of Extrinsic and Intrinsic Natures

Yuk Hoi Yiu, Christian Leibold^{1,3}

¹Albert-Ludwigs-Universität Freiburg, Theoretical Systems Neuroscience, Bernstein Center Freiburg, Hansastrasse 9a, 79104 Freiburg, Germany

²Ludwig Maximilians Universität München, Graduate School of Systemic Neurosciences, Großhaderner Straße 2, D-82152 Planegg-Martinsried, Germany

³Albert-Ludwigs-Universität Freiburg, BrainLinks-BrainTools, Bernstein Center Freiburg, Georges-Koehler-Allee 80, 79110 Freiburg, Germany

Spatial navigation requires planning a trajectory through a series of places. It has been suggested that the firing sequences of hippocampal place cells support the representation of spatial trajectories as sequences of locations. Specifically, the ordered spike times of place cells within theta oscillation cycles (4-12Hz) form a time-compressed representation of a behavioral sequence of place field locations on the millisecond timescale.

However, the mechanism underlying sequence generation remains unclear. Past studies proposed that theta sequences could either be extrinsic and driven by sensorimotor drives, or intrinsic and driven by hippocampal connectivity. The former would predict that theta sequences propagate along the behavioral trajectory, while the latter would render the sequence rigid in the direction of connectivity. Neither of the theories alone reconciles with the experimental observations that both extrinsic and intrinsic sequences can be found in the cornu ammonis 3 (CA3) region (Yiu et al., 2022). Here we develop a unifying model which can account for the coexistence of both sequences.

We simulated a spiking neural network with two layers of CA3 and dentate gyrus (DG) place cells in 2-D space. Extrinsic sequences are generated in the CA3 layer by the symmetrical weights with short-term depression (Romani & Tsodyks, 2015), which produces temporary asymmetrical recurrent feedback in the direction of travel by depleting the synaptic resources behind the animal's movement. Inspired by the anatomical evidence that CA3 forms an indirect feedback projection via DG, we designed the intrinsic sequences to propagate through the pre-existing recursive loops between CA3 and DG layers in fixed directions.

We demonstrated that, via a CA3-DG loop, intrinsic sequences are able to play out on top of their extrinsic counterpart in separate directions. As a result, theta sequences appear as a mixture of both kinds of sequences and display directionality as they cross each other at various angles, changing the slope and onset of the resultant phase precession. The directionality is consistent with previous findings that phase distribution shifts upward when place fields are traversed in their non-preferred directions. Finally, we show that intrinsic sequences can function as a stable landmark whose temporal patterns can be reliably decoded from multiple running directions. Such pre-existing temporal code might facilitate spatial memories before the animal becomes familiar with the environment.

Our model offers a mechanistic explanation of theta sequences which combines their extrinsic and intrinsic origins. It also provides insight into the role of internal hippocampal connectivity in spatial representation.

References:

Romani, S., & Tsodyks, M. (2015). Short-term plasticity based network model of place cells dynamics. *Hippocampus*, 25(1), 94–105. <https://doi.org/10.1002/hipo.22355>

Yiu, Y.-H., Leutgeb, J. K., & Leibold, C. (2022). Directional Tuning of Phase Precession Properties in the Hippocampus. *The Journal of Neuroscience*, 42(11), 2282–2297. <https://doi.org/10.1523/JNEUROSCI.1569-21.2021>

Symposium

S31: Magnetoreception – the sixth sense

[S31-1](#) Cryptochromes as primary magnetic sensors in migratory birds
Peter Hore, Jingjing Xu, Rabea Bartoelke

[S31-2](#) Loss of a potential magnetoreceptor in night migratory passerines – a phylogenetic analysis of cryptochromes in birds
Corinna Langebrake, Georg Manthey, Juan Lugo Ramos, Julien Dutheil, Henrik Mouritsen, Miriam Liedvogel

[S31-3](#) The neurobiology of light-dependent magnetoreception in migratory birds
Karin Dedek, Henrik Mouritsen

[S31-4](#) Radiofrequency effects on magnetic orientation behavior in birds
Bo Leberecht, Thimo Karwinkel, Siu Ying Wong, Ilja Solov`yov, Michael Winklhofer, P. J. Hore, Henrik Mouritsen, Heiko Schmaljohann

Cryptochromes as primary magnetic sensors in migratory birds

Peter Hore¹, Jingjing Xu², Rabea Bartoelke³

¹University of Oxford, Department of Chemistry, South Parks Road, OX1 3QZ Oxford, United Kingdom

²AG Neurosensory Sciences/Animal Navigation, Institute of Biology and Environmental Sciences, Carl-von-Ossietzky University Oldenburg, Germany

³AG Neurosensory Sciences/Animal Navigation, Institute of Biology and Environmental Sciences, Carl-von-Ossietzky University Oldenburg, Germany

Introduction

Migratory birds use the Earth's magnetic field to navigate during their spectacular migratory journeys¹. The mechanism of this magnetic compass is thought to be based on quantum effects in radical pairs (RPs) in cryptochrome (CRY) proteins located in the birds' retinas^{2,3}. Specifically, multiple electron transfers along a chain of tryptophan residues to the photoexcited chromophore flavin adenine dinucleotide (FAD) in CRY generates a spin-correlated flavin-tryptophan RP. It has been proposed that an external magnetic field could alter the time-dependent fractions of RPs present in the singlet and triplet electronic states and so change the product yields of spin-selective RP reactions⁴. We will present theoretical and experimental evidence supporting the light-induced formation of RPs in European robin CRY4a (*Erithacus rubecula*, *ErCRY4a*). Furthermore, a possible route of CRY signaling involving the α -subunit of the cone-specific heterotrimeric G protein will be discussed.

Methods

CRY4 proteins from the migratory European robin and non-migratory pigeon (*Columba livia*, *CICRY4*) and chicken (*Gallus gallus*, *GgCRY4*) were produced using an *E. coli* expression system. Magnetic field effects on these proteins were measured optically using a variety of spectroscopic techniques. Spin and molecular dynamics simulations were performed to shed additional light on the experimental results. Protein-protein interaction studies included surface plasmon resonance, pulldown affinity binding and FRET (Förster Resonant Energy Transfer) measurements.

Results

A long-lived spin-correlated RP is formed via light-induced electron hopping along a tetrad of tryptophan residues to the FAD in *ErCRY4a* (FIG. 1A and 1B). *ErCRY4a* shows a more pronounced magnetic field effect than either *CICRY4* or *GgCRY4* (FIG. 1C)⁵. The RP involving flavin and the third component of the tetrad (Trp_C) is highly magnetically sensitive, while the RP involving flavin and the fourth tryptophan (Trp_D) is long-lived and therefore suitable for signaling. Thus, we propose a composite radical pair model which could allow efficient magnetic sensing and signaling in bird magnetoreception (FIG. 1D)⁶. A downstream signaling cascade could involve the binding of *ErCRY4a* with the G protein as a first step in RP-based magnetotransduction⁷.

Conclusion

CRY4a from European robins is magnetically sensitive in vitro and could be the long sought magnetic sensor in night-migratory songbirds.

References

- ¹H. Mouritsen, Nature 558, 50-59 (2018)
- ²K. Schulten, et al., Z. Phys. Chem. 111, 1-5 (1978)
- ³T. Ritz, et al., Biophys. J. 78, 707-718 (2000)
- ⁴P. J. Hore & H. Mouritsen, Annu. Rev. Biophys. 45, 299-344 (2016)
- ⁵J. Xu et al., Nature, 594, 535-540 (2021)
- ⁶S. Y. Wong et al., J. R. Soc. Interface 18, 20210601 (2021)
- ⁷K. Görtemaker et al. Cells, 11, 2043 (2022)

Authors in alphabetical order:

Rabea Bartölke [1], Marco Bassetto [1,2], Elmar Behrmann [13], Heide Behrmann [13], Yogarany Chelliah [7,8], Glen Dautaj [1], Victoire Déjean [3], Jessica Fleming [2], Angela S. Gehrckens [2], Katharina Görtemaker [6], Matthew J. Golesworthy [3], Kevin B. Henbest [2,3], Maike Herrmann [1], Simon Horst [1], Lauren E. Jarocho [2], Stefanie J. Käsehagen [1], Bo Leberecht [1], Marcin Konowalczyk [3], Jiatae Luo [2], Gabriel Moise [3], Patrick D. F. Murton [2], Tommy L. Pitcher [3], Sabine Richert [4], Jessica Schmidt [1], Vita Solovyeva [10], Daniel J. C. Sowood [2], Joseph S. Takahashi [7,8], Jan-Oliver Voss [6], Jessica R. Walton [2], Stefan Weber [4], Yujing Wei [2], Haijia Wu [6], Can Xie [11], Jingjing Xu [1], Chad Yee [6], Hang Yin [5], Tilo Zollitsch [2]

PIs: Karl-Wilhelm Koch [6,9], Ilia A. Solov'yov [9,10], Stuart R. Mackenzie [2], Christiane R. Timmel [3,12], Henrik Mouritsen [1,9] & P. J. Hore [2]

- [1] AG Neurosensory Sciences/Animal Navigation, Institut fuer Biologie und Umweltwissenschaften, Carl-von-Ossietzky Universität Oldenburg, 26111 Oldenburg, Germany
- [2] Department of Chemistry, University of Oxford, Physical and Theoretical Chemistry Laboratory, Oxford OX1 3QZ, UK
- [3] Department of Chemistry, University of Oxford, Inorganic Chemistry Laboratory, Oxford OX1 3QR, UK
- [4] Institut fuer Physikalische Chemie, Albert-Ludwigs-Universität Freiburg, 79104 Freiburg, Germany
- [5] Department of Medicinal Chemistry and Molecular Pharmacology, Purdue University, West Lafayette, IN 47907, USA
- [6] Division of Biochemistry, Department of Neuroscience, Carl-von-Ossietzky Universität Oldenburg, DE-26111 Oldenburg, Germany
- [7] Department of Neuroscience, University of Texas Southwestern Medical Center, Dallas, TX 75390-9111, USA
- [8] Howard Hughes Medical Institute, University of Texas Southwestern Medical Center, Dallas, TX 75390-9111, USA
- [9] Research Centre for Neurosensory Science, University of Oldenburg, 26111 Oldenburg, Germany
- [10] Department of Physics, Carl-von-Ossietzky Universität Oldenburg, 26111 Oldenburg, Germany
- [11] CAS Key Laboratory of High Magnetic Field and Ion Beam Physical Biology, High Magnetic Field Laboratory, Hefei Institutes of Physical Science, Chinese Academy of Sciences, Hefei, Anhui 230031, PR China
- [12] Centre for Advanced Electron Spin Resonance (CAESR), Department of Chemistry, University of Oxford, Oxford OX1 3QR, UK
- [13] Institute of Biochemistry, Faculty of Mathematics and Natural Sciences, University of Cologne, 50674 Cologne, Germany

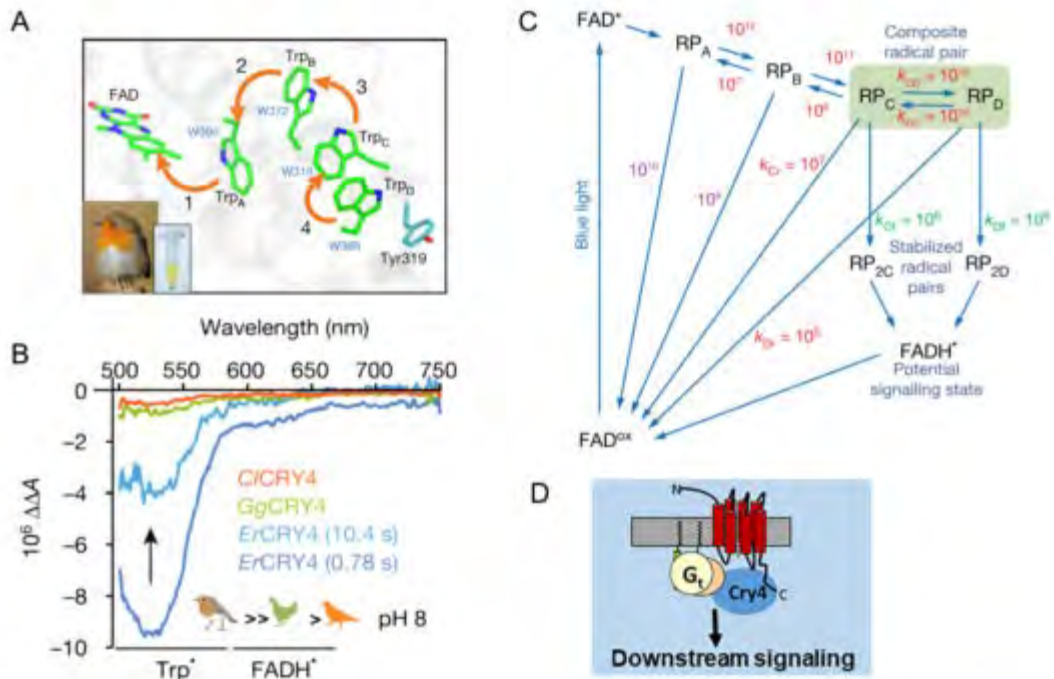

FIG. 1. A light-induced magnetically sensitive radical pair in CRY4 proteins. A, Structural homology model of European robin CRY4a showing sequential electron transfer from tryptophan residues (Trp, W) to the flavin adenine dinucleotide. The inset shows a robin and an ErCRY4a protein sample with FAD bound. B, change in the optical absorbance of photoinduced radicals in three avian CRY4 samples induced by a 30-mT magnetic field. C, A proposed reaction scheme involving the composite RP model for magnetic sensing and signaling in CRY4 from night-migratory songbirds. D, Hypothetical signaling of ErCRY4a in cone photoreceptor cells.

Loss of a potential magnetoreceptor in night migratory passerines – a phylogenetic analysis of cryptochromes in birds

Corinna Langebrake¹, Georg Manthey¹, Juan Lugo Ramos³, Julien Dutheil³, Henrik Mouritsen², Miriam Liedvogel¹

¹Institute for Avian Research, Behavioural Genomics, An der Vogelwarte 21, 26386 Wilhelmshaven, Germany

²University of Oldenburg, Germany

³Max Planck Institute for Evolutionary Biology, Plön, Germany

The accuracy of orientation and navigation of migratory birds is astonishing. To orient in the right direction, birds use various compass systems, one of which is the magnetic compass. Although behavioral experiments clearly demonstrate that birds sense the Earth's magnetic field and evidence for a radical-pair-mechanism has accumulated, we still have not conclusively identified the sensory molecule. The candidate molecules that have received most experimental support are cryptochromes (Cry). Here, we investigate Crys and their potential involvement in magnetoreception in a phylogenetic framework. We base our analysis on 363 bird genomes spread across the avian clade. We show that Cry4 was lost three times independently in hummingbirds, parrots and Tyranni (a basal form of passerines) which are mostly sedentary groups occurring in the tropics. This loss provides a natural comparative gene knockout which we utilize to test the orientation strategies of solitary night-migratory tyrant flycatchers, a perfect comparison to widely tested oscines such as the European robin with Cry4 present. The Cry4 sequence is very variable, which is in stark contrast to the other two cryptochrome genes (Cry1 and Cry2) which are highly conserved in all species, in line with very basal, non-sensory functions. In sum, our data strengthen the hypothesis that Cry4 is likely to be a sensor protein in (night)-migratory songbirds and we present a perfect system to test hypotheses of Cry4 functionality.

The neurobiology of light-dependent magnetoreception in migratory birds

Karin Dedek¹, Henrik Mouritsen¹

¹Neurosensory Sciences/Animal Navigation, Institute for Biology and Environmental Sciences, Carl von Ossietzky University of Oldenburg, 26129 Oldenburg, Germany

**A list of authors and affiliations appears below.*

Migratory birds use a magnetic compass sense to determine the direction in which they want to migrate¹. Evidence has accumulated that the magnetic compass of birds is light-dependent and mediated by blue light sensors, called cryptochromes, which are expressed in the retina. Birds express six different cryptochrome isoforms (reviewed in ²). Of these, cryptochrome 4a is the most likely sensor molecule for light-dependent magnetoreception³. It is expressed in the double cone photoreceptors of night-migratory songbirds⁴. To understand the magnetic compass sense, it is therefore important to study the retinal circuitry of birds. However, although birds are very visual animals and possess high visual acuity and superb color vision, data on the different retinal cell types, their connectivity, and spatial distribution is largely missing. We will summarize our recent progress in analyzing the retinal circuitry of different bird species and show how the specific orientation of avian double cones may allow the birds to separate the information from the Earth's magnetic field from variations in light intensity or polarization^{5,6}.

From the retina, magnetic information is likely sent to the thalamus (and not the optic tectum) from where the information is relayed to Cluster N, a part of the visual Wulst, shown to be essential for magnetic compass orientation in birds⁷. To understand how magnetic information is processed in these higher brain areas and integrated with information from other sensory modalities (e.g., the olfactory and trigeminal system), it is important to study the neuronal circuitry in the bird brain. We will summarize our recent progress in analyzing the neuronal connections within the bird brain relevant for magnetoreception and multi-cue integration⁸ and show that Cluster N could represent a central relay for the transmission of magnetic compass information to the hippocampal formation where the information might be integrated with other navigational cues in night-migratory songbirds⁹, before behavioral “commands” are sent to the motor output system.

References

- 1 H. Mouritsen, *Nature*, 558:50-59 (2018)
- 2 P. K. Seth et al., *Neuroforum*, 27:159–166 (2021)
- 3 J. Xu et al., *Nature*, 594:535-540 (2021)
- 4 A. Günther et al., *Curr Biol*, 28(2):211-223.e4 (2018)
- 5 S. Worster et al., *J R Soc Interface*, 14:20170405 (2017)
- 6 R. Chetverikova et al., *J R Soc Interface*, 19:20210877 (2022)
- 7 Zapka et al., *Nature*, 461:1274-7 (2009)
- 8 Kobylkov et al., *Neurosci Lett*, 789:136869 (2022)
- 9 Heyers et al., *Brain Struct Funct*, doi: 10.1007/s00429-022-02566-y (2022)

Authors in alphabetical order:

Vaishnavi Balaji¹, Petra Bolte¹, Kevin L. Briggman², Raisa Chetverikova¹, Glen Dautaj¹, Karin Dedek^{1,9}, Anja Günther^{1,2}, Onur Güntürkün³, Katrin Haase¹, Silke Haverkamp², Christina Herold⁴, Maike Herrmann¹, Dominik Heyers^{1,9}, Stephan Irsen⁵, Dmitry Kobylkov^{1,6}, Ezequiel Mendoza⁷, Henrik Mouritsen^{1,9}, Isabelle Musielak¹, Pavel Nemeč⁸, Leonie L. Pfeiffer¹, Noemi Rook³, Jessica Schmidt¹, Leonard Schwigon¹, Pranav K. Seth¹, Constance Scharff⁷, Kaya von Eugen³

1 Neurosensory Sciences/Animal Navigation, Institute for Biology and Environmental Sciences, Carl von Ossietzky University of Oldenburg, 26129 Oldenburg, Germany

2 Department of Computational Neuroethology, Max Planck Institute for Neurobiology of Behavior – caesar, 53175 Bonn, Germany

3 Institute for Cognitive Neuroscience, Department of Biopsychology, Faculty of Psychology, Ruhr-University Bochum, 44780 Bochum, Germany

4 Medical Faculty, Cécile and Oskar Vogt-Institute of Brain Research, University Hospital and Heinrich-Heine University Düsseldorf, 40225 Düsseldorf, Germany

5 Electron Microscopy and Analytics, Max Planck Institute for Neurobiology of Behavior – caesar, 53175 Bonn, Germany

6 Center for Mind/Brain Science, University of Trento, Rovereto, Italy

7 Institut für Biologie, Freie Universität Berlin, Berlin, Germany

8 Department of Zoology, Charles University, Prague, Czech Republic

9 Research Center Neurosensory Science, University of Oldenburg, Oldenburg, Germany

Radiofrequency effects on magnetic orientation behavior in birds

Bo Leberecht¹, Thiemo Karwinkel^{1,2}, Siu Ying Wong³, Ilja Solov`yov^{3,4}, Michael Winklhofer^{1,4}, P. J. Hore⁵, Henrik Mouritsen^{1,4}, Heiko Schmaljohann^{1,2}

¹Institute of Biology and Environmental Sciences, Animal Navigation Group, Carl-von-Ossietzky-Strasse 9-11, 26129 Oldenburg, Germany

²Institute of Avian Research "Vogelwarte Helgoland", 26386 Wilhelmshaven, Germany

³Institute for Physics, Carl von Ossietzky University Oldenburg, Oldenburg, Germany

⁴Research Center Neurosensory Science, Carl von Ossietzky University of Oldenburg, Oldenburg, Germany

⁵Department of Chemistry, University of Oxford, Oxford OX1 3QZ, UK

Billions of night-migratory songbirds migrate cross continents and oceans every year to reach their wintering grounds and breeding areas. One important cue that guides them on their journeys is the Earth's magnetic field. Currently, there is good evidence that songbirds perceive magnetic information via a sensor located in the retina. This so-called radical-pair mechanism seems to consist of a flavin adenine diphosphate and a tryptophan amino acid inside a magnetically sensitive cryptochrome protein.

Broadband electromagnetic noise (radio frequencies) fields are known to disrupt this sensor and hence, the bird's magnetic compass. Consequently, songbirds were disoriented in behavioural compass orientation experiments when the only cues for orientation were provided by Earth's magnetic field. Due to the physical properties of the cryptochrome molecule, quantum chemistry predicts which radio frequency fields would disturb the bird's magnetic compass and which not. Identifying those in controlled orientation experiments is important to verify the theoretical predictions of this sensor. In the framework of SFB 1372, we assessed different aspects of these underlying theories and predictions.

Certain radio frequency fields are responsible for the disruption of the birds' magnetic compass, depending on the organic nature of the sensor. In lab experiments with orientation cages (Emlen funnels), we tested predictions about the inhibiting effect of radio frequency fields on the magnetic compass orientation behaviour of night-migratory songbirds. Here we show that the avian magnetoreceptor is sensitive to the magnetic field for 2.2 – 10 μ s, and that the radio frequency fields above 140 MHz are unlikely to significantly disturb the magnetic compass in birds. Moreover, this indicates that the avian magnetoreceptor is consistent with the organic nature of a flavin-tryptophan radical pair.

Since anthropogenically generated radio frequencies, also called "electrosmog", are found almost everywhere on Earth, the question arises whether such radio frequency fields, as shown in cage experiments, would also affect free-flying migratory birds in the wild. To assess this, we exposed wild nocturnal songbirds to specific radio frequencies and tracked their behaviour in free flight using a large-scale network of digital radio receiving stations. We show that the birds' migratory behaviour, including departure probability, departure timing, departure direction, and the consistency of that flight direction, was largely unaffected by pre-exposure to radio frequencies. Although it appears that such radio frequencies have no long-term biological effects on migratory birds in general, we emphasise that our results do not provide general evidence that radio frequencies are harmless to animal behaviour or physiology.



Symposium

S32: Presynaptic calcium channels: key players in synaptic transmission and plasticity

[S32-1](#) Modulation of Ca_v1.3 channels by calcium binding proteins

Tina Pangrsic Vilfan, David Oestreicher, Shashank Sharad Chepurwar, Tatjana Pallinger, Taehee Kim, Ryo Motosugi, Eri Sakata, Kathrin Kusch, Vladan Rankovic, Nicola Strenzke

[S32-2](#) An active zone state switch concentrates and immobilizes voltage-gated Ca²⁺ channels to boost vesicle release

Stephan Johannes Sigrist, Tina Ghelani, Marc Escher, Ulrich Thomas, Klara Esch, Janine Lützkendorf, Harald Deppner, Marta Maglione, Pierre Parutto, Scott Gratz, Stefanie Ryglewski, Alexander Walter, David Holcman, Kate O'Connor Giles, Martin Heine

[S32-3](#) Functional synaptic diversity: from molecules to computations

David DiGregorio

[S32-4](#) Ca_v1.3 Ca²⁺ channels: key players in wide dynamic range sound encoding

Tobias Moser

[S32-5](#) Understanding synaptic mechanisms of sound intensity coding in mice with altered Ca_v1.3 gating

Nare Karagulyan, Anupriya Thirumalai, Qinghua Fang, Nadine J. Ortner, Jörg Striessnig, Tobias Moser

Modulation of Ca_v1.3 channels by calcium binding proteins

Tina Pangrsic Vilfan¹, David Oestreicher¹, Shashank Sharad Chepurwar², Tatjana Pallinger¹, Taehee Kim³, Ryo Motosugi³, Eri Sakata³, Kathrin Kusch⁴, Vladan Rankovic³, Nicola Strenzke²

¹University Medical Center Göttingen, Dept. of Otolaryngology/InnerEarLab, Robert-Koch-Str. 40, 37075 Göttingen, Germany

²University Medical Center Göttingen, Institute for Auditory Neuroscience/Dept. of Otolaryngology/InnerEarLab, Robert-Koch-Str. 40, 37075 Göttingen, Germany

³University Medical Center Göttingen, Institute for Auditory Neuroscience/InnerEarLab, Robert-Koch-Str. 40, 37075 Göttingen, Germany

⁴University Medical Center Göttingen, Institute for Auditory Neuroscience/InnerEarLab, and Auditory Neuroscience and Optogenetics Laboratory, German Primate Center, Kellnerweg 4, 37077 Göttingen, Germany

Neurotransmission is triggered by calcium influx through the voltage-gated calcium channels, which typically undergo considerable calcium- and voltage-dependent inactivation (CDI and VDI) to limit the amount of incoming calcium ions. However, to support proper calcium signalling in diverse tissues, the biophysical properties of these channels are tailored to the cell-specific requirements, which is primarily accomplished through different channel types, but also alternative splicing and distinct channel modulators. In the ear, the L-type Ca_v1.3 channels, mediate exocytosis at the inner hair cell (IHC) ribbon synapses. There, to support encoding of graded and sustained fluctuations in IHC membrane potential upon ongoing sound stimuli, these channels respond rapidly and display very slow inactivation. The central role in attenuating channel inactivation in the IHCs seem to be enabled by the action of calcium binding proteins, CaBPs. Here, we investigated the phenotype of *Cabp1* and *2* double-KO animals and the biochemical properties of these proteins in order to understand how they work together in regulating IHC synaptic function. Analysing the mouse phenotype from systems to cellular levels we find evidence for partially overlapping functions of these two proteins. The IHC synaptic and hearing impairment in the *Cabp2*- or *Cabp1/2*-deficient IHCs can be partially restored upon gene-mediated transfer of *Cabp2* in the inner ear. We conclude that CaBP1 and 2 together reduce CDI and VDI of IHC Ca_v1.3 channels and support sufficient rate of exocytosis to enable sound encoding.

An active zone state switch concentrates and immobilizes voltage-gated Ca²⁺ channels to boost vesicle release

Stephan Johannes Sigrist¹, Tina Ghelani^{1,2,3}, Marc Escher¹, Ulrich Thomas⁴, Klara Esch¹, Janine Lützkendorf¹, Harald Deppner¹, Marta Maglione¹, Pierre Parutto^{6,7}, Scott Gratz⁹, Stefanie Ryglewski⁵, Alexander Walter², David Holcman^{6,8}, Kate O`Connor Giles^{9,10}, Martin Heine⁵

¹Institute for Biology and Genetics, Freie Universität Berlin, Takustraße 6, 14195 Berlin, Germany

²Molecular and Theoretical Neuroscience Leibniz-Forschungs institut für Molekulare Pharmakologie (FMP) im CharitéCrossOver (CCO) Charité - University Medicine Berlin Charité Campus Mitte Charité Platz 110117 Berlin

³Institute for Biology and Genetics, Freie Universität Berlin, Takustraße 6, 14195 Berlin, Germany; NeuroCure Cluster of Excellence, Charité Universitätsmedizin, Charitéplatz 1, 10117 Berlin,

⁴Research Group Molecular Physiology, Leibniz-Institute for Neurobiology, Brenneckestr. 6, 39118 Magdeburg, Germany

⁵Institute of Developmental Biology and Neurobiology, Johannes Gutenberg University Mainz, Mainz, Germany

⁶Group of Applied Mathematics and Computational Biology, IBENS, Ecole Normale Supérieure, Paris, France

⁷Dementia Research Institute at University of Cambridge, Department of Clinical Neurosciences, Cambridge CB2 0AH, United Kingdom

⁸Churchill College, University of Cambridge, Cambridge CB3 0DS, UK

⁹Department of Neuroscience, Brown University, Providence, Rhode Island 02912

¹⁰Carney Institute for Brain Science, Brown University, Providence, RI 02912

At presynaptic active zones (AZs), a conserved scaffold protein architecture controls synaptic vesicle (SV) release by steering the nanoscale distribution and density of voltage-gated Ca²⁺ channels. Whether and if how presynaptic plasticity mechanisms utilize nanoscale changes of voltage-gated Ca²⁺ channels remains to be explored.

We recently established intravital single-molecule imaging of endogenously tagged Ca_v2 type-Ca²⁺ channel Cacophony (Cac) at *Drosophila* AZs triggered towards homeostatic potentiation.

At potentiating AZs, Cac channel numbers increased, their mobility decreased, and their overall distribution became more compact. This compaction seems driven by an interaction connecting the intracellular Ca²⁺ channel C-term with AZ plasma membrane-close N-term of the ELKS-family scaffold protein Bruchpilot (BRP). As single molecule imaging of BRP pictured an extensive plasticity-driven compaction, our data suggest that switching to a compacted AZ BRP scaffold state concentrates and immobilizes individual Ca²⁺ channels to sustain enduring potentiation of AZ release.

I will present work to corroborate these statements, and report about our attempts to deeper understand the structural and functional dynamics of AZ scaffolds steering AZ assembly and plasticity relevant for memory consolidation and sleep homeostasis.

Functional synaptic diversity: from molecules to computations

David DiGregorio¹

¹Institut Pasteur, CNRS, Université Paris Cité, Neuroscience Department, 25 rue du docteur Roux, 75015 Paris, France

One hallmark of synapses throughout the nervous system is their functional heterogeneity, which is thought to impart important computational properties to neuronal circuits. Yet the cellular and molecular underpinnings of functional diversity and how they influence information processing in the brain are still poorly understood. The cerebellar cortex is a prototypical brain circuit important for fine-tuning precise motor and cognitive behaviors on the subsecond scale. We propose that presynaptic diversity in synaptic strength and short-term plasticity within the cerebellum is a substrate for biological timers necessary to execute precisely timed actions. Using optophysiology and electron microscopy, we found that the nanoscale topography of calcium channel density and distribution relative to synaptic vesicles can influence synaptic strength and plasticity. To gain deeper insight into the computational impact of synaptic transmission with a diverse range of short-term plasticity, we implemented an artificial neural network embedded with dynamic synapses modeled on experimental findings. Simulations showed that synapses with heterogeneous short-term plasticity could generate diverse neuronal firing patterns within the cerebellar network, which could be used as a basis set to create the precise neural activity necessary to drive motor actions. Finally, we will present the first experimental evidence, using high-speed calcium and glutamate imaging in awake animals, of the rich neural dynamics generated by the diverse functional synapses. These data demonstrate how specific presynaptic molecular organization could act as an intrinsic, unique, and ubiquitous mechanism for sculpting neural dynamics to represent sensory information and learning motor actions.

Ca_v1.3 Ca²⁺ channels: key players in wide dynamic range sound encoding

Tobias Moser¹

¹University Medical Center Göttingen, Institute for Auditory Neuroscience, Robert-Koch-Str. 40, 37075 Göttingen, Germany

²Auditory Neuroscience and Synaptic Nanophysiology Group, Max Planck Institute for Multidisciplinary Sciences, Göttingen, Germany

Our sense of hearing processes stimuli that differ in sound pressure by more than six orders of magnitude. Yet, while presynaptic inner hair cells (IHCs) cover entire audible range, each postsynaptic spiral ganglion neuron (SGN) encodes only a fraction. SGNs tuned to a given sound frequency differ in their spontaneous and sound-evoked firing. These functionally diverse SGNs seem to tile the audible range and collectively encode sound intensity. Recently, major heterogeneity of afferent SGNs synapses with IHCs has been discovered. IHCs seem to vary the number, voltage-dependence and release site coupling of Ca_v1.3 Ca²⁺ channels among its dozen of afferent synapse. The presentation will report recent findings on this presynaptic heterogeneity formed within individual IHCs. I will discuss such synaptic heterogeneity as candidate mechanism for generating diverse functional properties of SGNs for encoding the entire range of audible sound intensities in complementary neural codes.

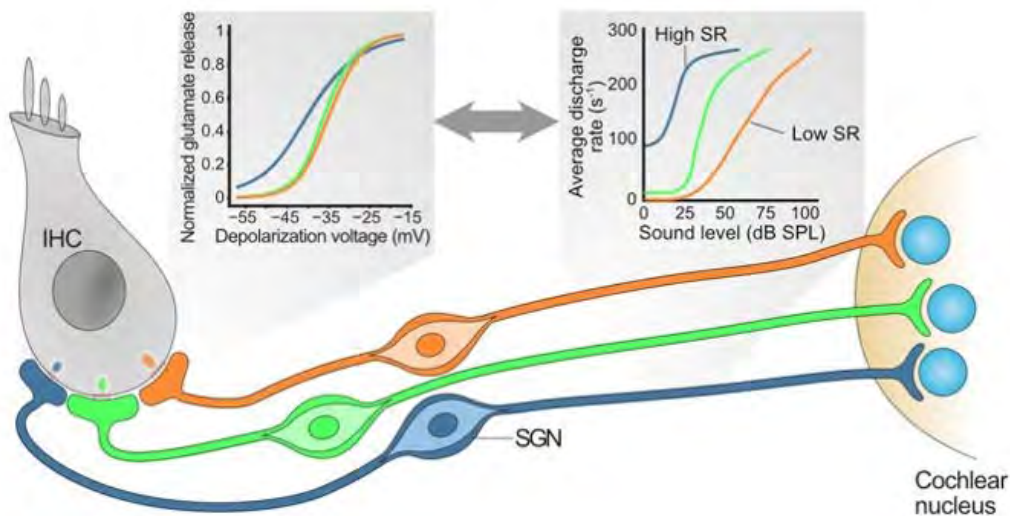

Inner hair cells (IHCs) diversify their presynaptic active zones likely to decompose sound intensity information into complementary codes of postsynaptic spiral ganglion neurons (SGNs).

Understanding synaptic mechanisms of sound intensity coding in mice with altered $Ca_v1.3$ gating

Nare Karagulyan, Anupriya Thirumalai^{1,4,6}, Qinghua Fang^{1,2}, Nadine J. Ortner⁶, Jörg Striessnig⁶, Tobias Moser^{1,2,3,4,5}

¹Institute for Auditory Neuroscience, University Medical Center Göttingen, 37075 Göttingen, Germany

²Auditory Neuroscience and Nanophysiology Group, Max Planck Institute of Multidisciplinary Sciences, 37075 Göttingen, Germany

³Collaborative Research Center 889, University of Göttingen, Göttingen, Germany

⁴Göttingen Graduate School for Neurosciences and Molecular Biosciences, University of Göttingen, Göttingen, Germany

⁵Multiscale Bioimaging Cluster of Excellence (MBExC), University of Göttingen, 37075 Göttingen, Germany

⁶Department of Pharmacology and Toxicology, Center for Molecular Biosciences Innsbruck, University of Innsbruck, Innsbruck, Austria

The mammalian auditory system processes sound pressures ranging over six orders of magnitude. This is enabled by cochlear micromechanics, adaptation and functional diversity of type I spiral ganglion neurons (SGNs) and their synapses with inner hair cells (IHCs). SGNs of similar characteristic frequency display wide range of thresholds and spontaneous rates (SR), giving rise to three distinct groups: low SR, medium SR and high SR SGNs.

Exactly how SGNs achieve such diverse functional properties remains unknown. The presynaptic hypothesis states that a single IHC driving activity in several SGNs, fractionates the receptor potential into complementary neural codes through heterogeneous presynaptic active zones (AZs). AZs within an IHC display highly variable Ca^{2+} influx amplitude, voltage-dependence of Ca^{2+} channel activation and stimulus-release coupling (Frank et al., 2009; Meyer et al., 2009; Özçete and Moser, 2020). The heterogeneity of voltage-dependence of synaptic Ca^{2+} influx provides a plausible explanation for the presynaptic control of the SGN spiking pattern: synapses with more hyperpolarized Ca^{2+} influx and subsequent glutamate release would be expected to drive higher SRs and low thresholds in the corresponding SGNs.

To test this, we employed mice harboring a point mutation (A749G) in $Ca_v1.3$ channels ($Ca_v1.3^{A749G/A749G}$). The A749G mutation is a de novo mutation in autism spectrum disorder and was previously shown in heterologous expression systems to cause a major hyperpolarized shift in the voltage dependence of $Ca_v1.3$ activation (Pinggera et al., 2015). By combining patch-clamp from IHCs with Ca^{2+} and glutamate imaging, we performed a detailed analysis of functional heterogeneity at presynaptic AZs in IHCs of $Ca_v1.3^{A749G/A749G}$ mice. On average, we observed a ~ 15mV hyperpolarized shift of the half-maximal activation of Ca^{2+} influx and glutamate release at single AZs of $Ca_v1.3^{A749G/A749G}$ IHCs. Non-stationary fluctuation analysis showed an increased open channel probability and a decreased number of Ca^{2+} channels in IHCs of mutant mice, which is consistent the parallel observation of smaller $Ca_v1.3$ immunofluorescent clusters. Our preliminary results from single unit recordings show increased SRs in SGNs of $Ca_v1.3^{A749G/A749G}$ mice compared to their wild-type littermates, supporting the presynaptic hypothesis.

Frank, T., Khimich, D., Neef, A., and Moser, T. (2009). Mechanisms contributing to synaptic Ca^{2+} signals and their heterogeneity in hair cells. *Proc. Natl. Acad. Sci. U. S. A.*

Meyer, A.C., Frank, T., Khimich, D., Hoch, G., Riedel, D., Chapochnikov, N.M., Yarin, Y.M., Harke, B., Hell, S.W., Egner, A., et al. (2009). Tuning of synapse number, structure and function in the cochlea. *Nat. Neurosci.*

Özçete, Ö.D., and Moser, T. (2020). A sensory cell diversifies its output by varying Ca^{2+} influx - release coupling among active zones . *EMBO J.*

Pinggera, A., Lieb, A., Benedetti, B., Lampert, M., Monteleone, S., Liedl, K.R., Tuluc, P., and Striessnig, J. (2015). CACNA1D de novo mutations in autism spectrum disorders activate $\text{Ca}_v1.3$ L-type calcium channels. *Biol. Psychiatry.*

Symposium

S33: Bridging brain function and microglia signaling

- [S33-1](#) Phantom Inflammation: A new paradigm to investigate microglia-to-neuron signaling
Thomas G Oertner
- [S33-2](#) Microglia activation determines the effect of TNF α on synaptic plasticity
Dimitrios Kleidonas, Matthias Kirsch, Geoffroy Andrieux, Dietmar Pfeifer, Melanie Boerries, Andreas Vlachos
- [S33-3](#) The myeloid side of the brain
Marco Rudolf Prinz
- [S33-4](#) Microglia sense neuronal activity via GABA in the early postnatal hippocampus
Marcus Semtner, Francesca Logiacco, Pengfei Xia, Svilen Georgiev, Celeste Franconi, Yi-Jen Chang, Bilge Ugursu, Anje Sporbart, Ralf Kühn, Helmut Kettenmann
- [S33-5](#) Role of microglia in white matter aging
Mikael Simons

Phantom Inflammation: A new paradigm to investigate microglia-to-neuron signaling

Thomas G Oertner¹

¹ZMNH, Universitätsklinikum Hamburg-Eppendorf

Activation of microglia by inflammatory processes or chronic diseases has profound consequences on neurons and synapses. The details of this communication between the immune system and the brain are under active investigation. Common strategies to activate microglia, such as induction of experimental autoimmune encephalomyelitis (EAE) or injection of bacterial lipopolysaccharide (LPS) activate primarily the peripheral immune system, triggering a complex and protracted reaction of the whole organism including the break-down of the blood-brain barrier. To directly activate microglia with precise timing we used chemogenetic activation of Gq. In response, microglia rapidly retracted their processes, long-term potentiation was significantly reduced and the total number of synapses between excitatory neurons slowly decreased. In water maze experiments, mice with activated microglia had no problem learning the position of a hidden platform, but were unable to remember it 48 h later. The chemogenetic intervention, which we termed 'phantom inflammation', allows studying the effects of microglia on synaptic function with excellent temporal resolution and no risk of direct neuronal or astrocytic activation.

Microglia activation determines the effect of TNF α on synaptic plasticity

Dimitrios Kleidonas, Matthias Kirsch^{1,4}, Geoffroy Andrieux⁵, Dietmar Pfeifer⁶, Melanie Boerries^{5,7}, Andreas Vlachos^{1,4,8}

¹Department of Neuroanatomy, Institute of Anatomy and Cell Biology, Faculty of Medicine, University of Freiburg, Freiburg, Germany

²Spemann Graduate School of Biology and Medicine, University of Freiburg, Freiburg, Germany

³Faculty of Biology, University of Freiburg, Freiburg, Germany

⁴Center BrainLinks-BrainTools, University of Freiburg, Freiburg, Germany

⁵Institute of Medical Bioinformatics and Systems Medicine, Medical Center - University of Freiburg, Faculty of Medicine, University of Freiburg, Freiburg, Germany

⁶Department of Hematology, Oncology and Stem Cell Transplantation, Medical Center-University of Freiburg, Faculty of Medicine, University of Freiburg, Freiburg, Germany

⁷German Cancer Consortium (DKTK) Partner Site Freiburg, German Cancer Research Center (DKFZ), Heidelberg, Germany

⁸Center for Basics in NeuroModulation (NeuroModulBasics), Faculty of Medicine, University of Freiburg, Freiburg, Germany

Microglia comprise the major source of the pro-inflammatory cytokine tumor necrosis factor α (TNF α) in the central nervous system. Nevertheless, their role in TNF α -mediated synaptic plasticity remains poorly understood. Here, we assessed concentration-dependent effects of TNF α on microglia activation and the subsequent modulation of synaptic excitation/inhibition balance in organotypic entorhino-hippocampal tissue cultures prepared from mice of both sexes. Whole-cell patch-clamp recordings of CA1 pyramidal neurons, immunohistochemistry, transcriptome analysis, ELISA and live-cell imaging were used to investigate the role of microglia in TNF α -mediated synaptic plasticity. Our results demonstrate concentration-dependent effects of TNF α on neurotransmission that are associated with the activation state of microglia. Specifically, we observed that low concentrations of TNF α (60 pM, 24 h), which do not activate microglia, enhanced excitatory neurotransmission without affecting inhibition. Moreover, low TNF α induced the incorporation of GluA2-lacking AMPA receptors into the postsynaptic membrane. Conversely, a higher concentration of TNF α (6 nM, 24 h), which activated microglia, did not change baseline excitatory neurotransmission but robustly enhanced inhibition. High TNF α enhanced excitatory neurotransmission in microglia-depleted tissue cultures, similarly to what we observed with the low TNF α concentration that did not activate microglia. Taken together, these findings signify the role of microglia in TNF α -mediated synaptic plasticity. Specifically, they suggest that activated microglia act as gatekeepers of homeostasis by preventing deleterious effects of hyperexcitation.

The myeloid side of the brain

Marco Rudolf Prinz¹

¹Medical Center - University of Freiburg, Institute of Neuropathology, Breisacher Str. 64, 79106 Freiburg, Germany

The diseased brain hosts a heterogeneous population of myeloid cells, including parenchymal microglia, perivascular cells, meningeal macrophages and blood-borne monocytes. To date, the different types of brain myeloid cells have been discriminated solely on the basis of their localization, morphology and surface epitope expression. However, recent data suggest that resident microglia may be functionally distinct from bone marrow- or blood-derived phagocytes, which invade the CNS under pathological conditions. During the last few years, research on brain myeloid cells has been markedly changed by the advent of new tools in imaging, genetics and immunology. These methodologies have yielded unexpected results, which challenge the traditional view of brain macrophages. On the basis of these new studies brain myeloid subtypes can be differentiated with regard to their origin, function and fate in the brain.

Microglia sense neuronal activity via GABA in the early postnatal hippocampus

Marcus Semtner¹, Francesca Logiacco^{1,5,6}, Pengfei Xia¹, Svilen Georgiev^{1,4,7}, Celeste Franconi¹, Yi-Jen Chang¹, Bilge Ugursu^{1,2}, Anje Sporbert⁴, Ralf Kühn³, Helmut Kettenmann^{1,8}

¹MDC Berlin, Cellular Neurosciences, Robert-Roessler-Str. 10, 13125 Berlin, Germany

²Experimental Ophthalmology, Charité Universitätsmedizin Berlin, Augustenburger Platz 1, 13353 Berlin

³Transgenic Core Facility, Max-Delbrück-Center for Molecular Medicine in the Helmholtz Association, 13125 Berlin, Germany

⁴Advanced Light Microscopy, Max-Delbrück-Center for Molecular Medicine in the Helmholtz Association, 13125 Berlin, Germany

⁵Department of Biology, Chemistry, and Pharmacy, Freie Universität Berlin, 12169 Berlin, Germany

⁶Neurobiology of Ageing, AG Schaefer, Max-Planck-Institut für Biologie des Alterns, Joseph-Stelzmann-Str. 9b, 50931 Köln, Germany

⁷University Medical Center Göttingen, Institute for Neuro- and Sensory Physiology, Göttingen, Germany

⁸ Shenzhen Institutes of Advanced Technology, Chinese Academy of Sciences, Shenzhen, China

Microglia, the resident macrophages in the central nervous system, express receptors for classical neurotransmitters, such as GABA and glutamate, suggesting their potential for sensing synaptic activity. To detect microglial Ca²⁺ responses to neuronal activity, we generate transgenic mouse lines expressing the fluorescent Ca²⁺ indicator GCaMP6m specifically in microglia and demonstrate that electrical stimulation of the Schaffer collateral pathway results in microglial Ca²⁺ responses in early postnatal, but not adult hippocampus. Preceding the microglial responses, we observe similar Ca²⁺ responses also in astrocytes, and both were sensitive to tetrodotoxin. Blocking astrocytic glutamate uptake or GABA transport abolishes stimulation-induced microglial responses, as well as antagonizing the microglial GABAB receptor. Our data therefore suggest that the neuronal activity-induced glutamate uptake and release of GABA by astrocytes triggers the activation of GABAB receptors in microglia. This neuron, astrocyte and microglia communication pathway might modulate microglial activity in developing neuronal networks.

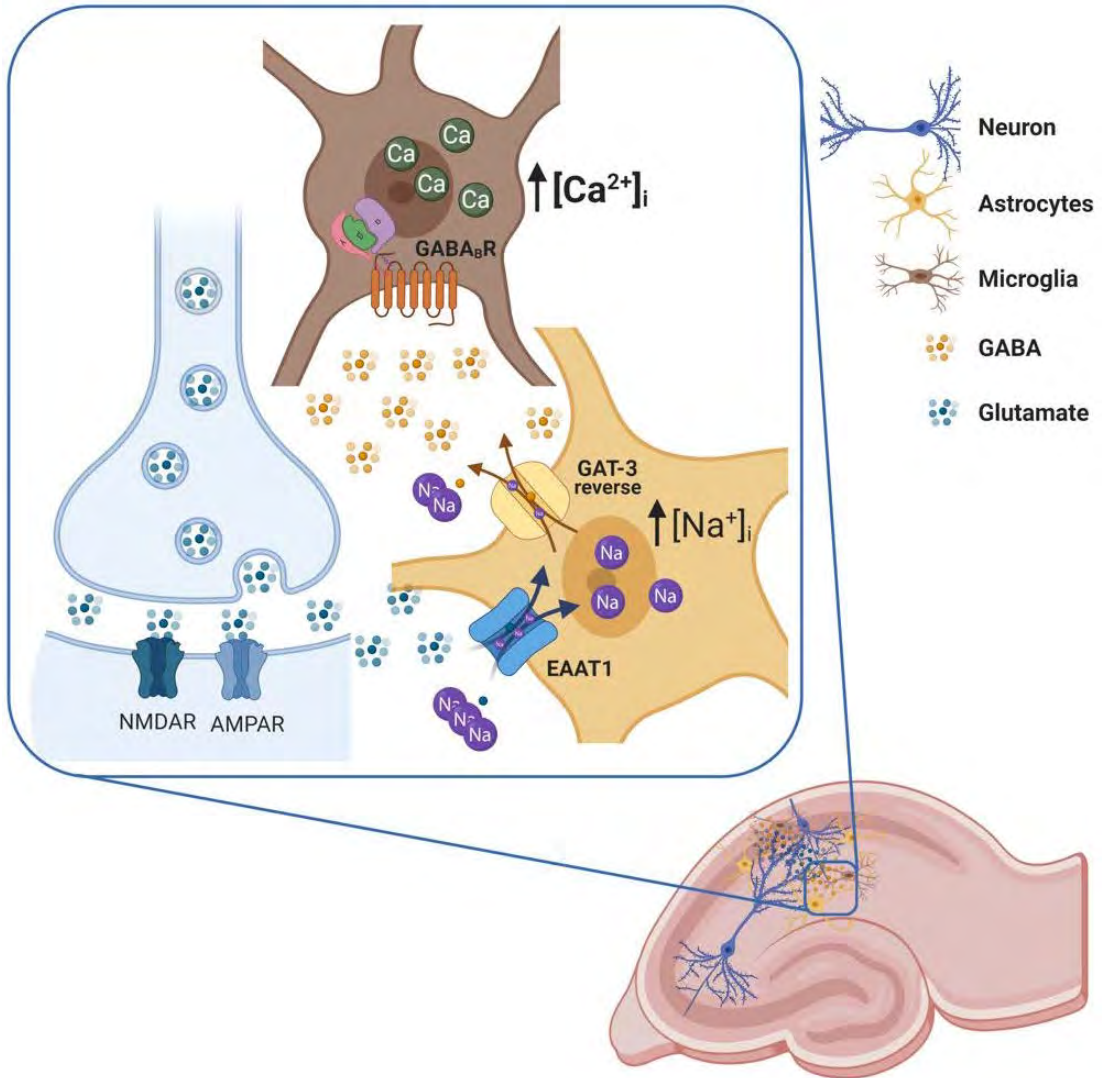

Role of microglia in white matter aging

Mikael Simons¹

¹TU Munich & DZNE, Molecular Neurobiology, Feodor-Lynen-Straße 17, 81377 Munich, Germany

A hallmark of nervous system aging is a decline of white matter volume and function, but the underlying mechanisms leading to white matter pathology are unknown. Here, we found age-related alterations of oligodendrocytes with a reduction of total oligodendrocyte density in the aging murine white matter. Using single-cell RNA sequencing, we identify interferon-responsive oligodendrocytes, which localize in proximity of CD8+ T cells in the aging white matter. Absence of functional lymphocytes decreased oligodendrocyte reactivity and rescued oligodendrocyte loss, while T-cell checkpoint inhibition worsened the aging affect. In summary, we provide evidence that T cells induced interferon-responsive oligodendrocytes are important modifiers of white matter aging.

Symposium

S34: Novel insights into hypothalamic mechanisms for adaptive control of homeostasis

[S34-1](#) Hypothalamic astrocytes in the neuroendocrine control of metabolism
Cristina Garcia Caceres

[S34-2](#) Sensing and control of ingestion by orexin neurons
Paul Viskaitis

[S34-3](#) Neural circuit basis underlying a hunger-gated, hormone-primed parental switch
Mingran Cao, Rachida Ammari, Johannes Kohl

[S34-4](#) Hypothalamic circuits for oxytocin release and maternal behavior
Silvana Valtcheva

[S34-5](#) A central pivotal controller for thermal homeostasis and fever
Kazuhiro Nakamura, Yoshiko Nakamura

Hypothalamic astrocytes in the neuroendocrine control of metabolism

Cristina Garcia Caceres¹

¹Institute for Diabetes and Obesity, Helmholtz Diabetes Center, Helmholtz Munich and Medizinische Klinik und Poliklinik IV, Klinikum der Universität, Ludwig-Maximilians-Universität München, Munich, Germany

The underlying basis for understanding of how brain control energy homeostasis, resides in a functional and coordinate communicating pathways between peripheral endocrine organs and the brain, in which the hypothalamus plays a pivotal role in the integration and processing of peripheral metabolic cues into satiety and feeding signals. Glial cells in particular astrocytes, as being an integral cell type of the neurovascular unit forming direct physical contacts with cerebral blood vessels, occupy a privileged position within the brain parenchyma to survey the metabolic status of the organism and to, in turn, modulate the activity of local neurocircuitries to match with whole-body energy demands. Via both physical contact and by releasing an array of soluble factors, astrocytes crucially contribute to control the selective access of circulating factors into the brain. Consistent with this, our previous studies have demonstrated that insulin signaling in astrocytes regulate the glucose entry into the brain and in turn cooperate with neurons in the regulation of feeding and systemic glucose metabolism. We have recently reported that astrocytes also respond to other peripheral hormones like leptin to promote hypothalamic angiogenesis and hypertension in diet-induced obesity. Interestingly, we observed that silencing specific metabolic receptors in hypothalamic astrocytes prevent microvascular dysfunction and the rise of systemic blood pressure in response to high-calorie diets. Therefore, our findings and ongoing studies are focused on unraveling the cellular and molecular basis in the communication between astrocytes and neurovascular beds for the brain control of metabolism, as representing potential cellular targets to fight obesity and its comorbidities such as hypertension.

Sensing and control of ingestion by orexin neurons

Paul Viskaitis

¹ETH Zürich , D-HEST, Schorenstrasse 16, 8603 Schwerzenbach, Switzerland

Orexin/hypocretin neurons of the lateral hypothalamus (HONs) project brain-wide, orchestrating such a diversity of brain states and behaviors that they have been called “brain government”. However, many aspects of how HONs “decide” when to become more or less active, and conversely, what their activity means for fundamental behaviors such as eating, remain debated. It was proposed, based on in vitro studies, that HONs are suppressed by glucose and activated by non-essential amino acids, thereby allowing them to adjust ingestive behavior according to ingested nutrients. Specifically, glucose-induced HON inhibition was hypothesized to provide negative feedback on eating. We tested this hypothesis in vivo, using sensing and actuating (fiberoptic and optogenetic) technologies targeted to HONs. Similar to in vivo experiments, we found that in vivo HONs are acutely activated by non-essential amino acids, and inhibited by glucose. However, the temporal dynamics of HON responses to blood glucose suggests that HONs are “change detectors” of glucose levels. Furthermore, data from HON deletion and optogenetic stimulation suggest that HON activity acutely suppresses eating and initiates foraging-like behaviors. These new in vivo findings suggest that the “HON negative feedback model” of eating control by ingested nutrients needs to be revised.

Neural circuit basis underlying a hunger-gated, hormone-primed parental switch

Mingran Cao, Rachida Ammari¹, Johannes Kohl¹

¹Francis Crick Institute, Kohl Lab, 12 Anthems Way, E20 1DD London, United Kingdom

Animals have sets of instinctive behaviours such as feeding, drinking, mating, parenting and aggression that are crucial for survival and procreation. Different instinctive behaviours are characterised by stereotypic actions in response to specific cues (e.g. parenting towards infants, aggression towards conspecifics). Despite their stereotypy, these behaviours can exhibit a large degree of flexibility due to experience or changes in internal states. While considerable advances have been made in understanding how individual instinctive behaviours are controlled by dedicated neural circuits, how these circuits are modified by the internal states of the animals to balance competing needs is less clear. Specifically, it remains unknown how identical sensory stimuli can result in different, or even opposing, instinctive behaviours due to organisms' physiological (e.g. hunger) and hormonal (e.g. estrous cycle) states.

Here we address this question by characterising interactions between circuits for food seeking and those controlling parental behaviour. We find that mild food deprivation switches female mice from parental behaviour to pup-directed aggression. Remarkably, this 'parental switch' is highly target-specific, rather than a state of general aggressivity. Chemogenetic activation of AgRP neurons in the arcuate nucleus is sufficient to elicit the switch. Using hypothalamus-wide immediate early gene mapping, we identify candidate nodes of parenting circuits that are both targeted by AgRP neurons and the activity of which is suppressed when animals switch towards pup-directed aggression. We are currently performing projection-specific optogenetic manipulations and *in vivo* recordings from neurons in parenting circuits to uncover the hunger-induced plasticity mechanisms underlying this drastic behavioural switch.

The parental switch is also highly dependent on animals' hormonal state. We find that the plasma progesterone-to-estradiol (P4-to-E2) ratio is highly correlated with, and can predict switching probability. Using conditional knockout of estrogen or progesterone receptors, we identify the medial preoptic area of the hypothalamus as the site of hormone action. We are currently performing channelrhodopsin-mediated circuit mapping on the AgRP-MPOA projection to characterise the cellular mechanism underlying this hormonal effect.

Hypothalamic circuits for oxytocin release and maternal behavior

Silvana Valtcheva¹

¹University of Cologne, Institut for Vegetative Physiology, Robert-Koch-Str. 39, 50931 Cologne, Germany

Maternal care is critical for child survivor. Early mother-infant relationships have long-term effects on the cognitive, behavioral, and emotional development, and overall health of the offspring. Various sensory cues from the newborn are tremendously efficient in triggering parental responses in new mothers. Deficits in maternal care can lead to deleterious long-term effects on child development. This makes research on neural networks involved in maternal reactivity to infant cues of tremendous clinical relevance. Oxytocin is a neuropeptide important for parturition and milk ejection during nursing, but it is also believed to powerfully enhance pro-social and parental behavior by acting to increase the salience of social cues. Suckling triggers oxytocin release, but other sensory cues- specifically infant cries- can elevate oxytocin levels in new human mothers indicating that cries can activate hypothalamic oxytocin neurons.

We found that hypothalamic oxytocin neurons in maternal mice (dams) can respond to auditory cues from newborns and subsequently release oxytocin. By performing *in vivo* cell-attached and whole-cell recordings from optically-identified oxytocin neurons, as well as fiber photometry of oxytocin cells in awake dams, we found that oxytocin neurons, but not other hypothalamic cells, are activated following playback of pup distress vocalizations to release oxytocin centrally. Using anatomical tracings and functional circuit mapping, we described a neural circuit routing auditory information about infant vocalizations via the posterior intralaminar thalamus to the hypothalamus. Studies of synaptic plasticity in acute brain slices revealed that persistent activation of oxytocin neurons following pup calls *in vivo* is likely mediated by a long-term depression of synaptic inhibition in these cells. Finally, chemogenetic inhibition of thalamic inputs to the hypothalamus, perturbed auditory-driven maternal behavior in dams. Our data show that this noncanonical auditory circuit gates central oxytocin release and maternal behavior in response to infant vocalizations, providing a mechanism for the integration of sensory cues from the offspring in maternal endocrine networks to ensure modulation of brain state for successful parenting.

maternal oxytocin release induced by infant cries.

A central pivotal controller for thermal homeostasis and fever

Kazuhiro Nakamura¹, Yoshiko Nakamura¹

¹Department of Integrative Physiology, Nagoya University Graduate School of Medicine, 65 Tsurumai, Showa-ku, 466-8550 Nagoya, Japan

The main controller of the thermoregulatory center in the preoptic area (POA) has yet to be determined. Using rats, we discovered that prostaglandin EP3 receptor-expressing POA neurons (POA^{EP3R} neurons) are a pivotal bidirectional controller in the central thermoregulatory circuit mechanism. POA^{EP3R} neurons were activated in response to elevated ambient temperature, but inhibited by prostaglandin E₂, a pyrogenic mediator. Chemogenetic stimulation of POA^{EP3R} neurons at room temperature reduced body temperature by eliciting skin vasodilation (enhancing heat dissipation), whereas inhibition of them elicited hyperthermia involving brown adipose tissue thermogenesis and tachycardia, mimicking fever. We also found that POA^{EP3R} neurons innervate sympathoexcitatory neurons in the dorsomedial hypothalamus (DMH) via tonic inhibitory signaling. Although many POA^{EP3R} neuronal cell bodies expressed a glutamatergic mRNA marker, paradoxically, their axons in the DMH predominantly released GABA and their GABAergic terminals were increased by chronic heat exposure. These findings demonstrate that tonic GABAergic inhibitory signaling from POA^{EP3R} neurons is a fundamental determinant of body temperature for thermal homeostasis and fever.

Symposium

S35: Insights into the neural basis of cognition from human intracranial electrophysiology

[S35-1](#) Tracking memory representations with iEEG
Hui Zhang

[S35-2](#) From continuous streams to segmented units: understanding how events structure cognition & memory
Lucia Melloni

[S35-3](#) Population coding and oscillatory subspace synchronization integrate context into actions
Randolph Helfrich

[S35-4](#) Dissociable mechanisms for “what” and “when” predictions in the human brain
Caspar Martin Schwiedrzik

[S35-5](#) Distinct populations in human MTL combine items and contexts across temporal gaps
Marcel Bausch, Johannes Niediek, Thomas P. Reber, Sina Mackay, Jan Boström, Christian E. Elger, Florian Mormann

Tracking memory representations with iEEG

Hui Zhang¹

¹Ruhr-Universität Bochum, Neuropsychology, Universitätsstraße 150, 44801 Bochum, Germany

While engrams cannot be directly studied in humans, recent years have seen abundant research on the representation of specific contents via meso- and macroscale networks. These networks can be identified via various multivariate analysis methods, and tracked during different stages of memory processing. Intracranial EEG recordings are particularly relevant in this regard because of their high temporal resolution and access to deep brain regions such as the hippocampus. In my talk, I will present recent studies on both the reinstatement and the transformation of stimulus-specific memory traces.

From continuous streams to segmented units: understanding how events structure cognition & memory

Lucia Melloni¹

¹Max Planck Institute for Empirical Aesthetics, Neural Circuits, Consciousness and Cognition, Gruneburweg 14, 60322 Frankfurt am Main, Germany

While perceptual information arrives in a more-or-less continuous manner over time, our mind apprehends coherent and bounded subsequences that have beginnings, middles and ends and feel extended over time. For example, speech unfolds continuously without pauses between words, yet we understand meaningful units, at multiple hierarchical level, such as phonemes, syllables, words, and sentences, and ‘hallucinate’ pauses at the rate of those perceived mental units. A core problem has been to understand how and why the continuous flow of experience is partitioned in this way. In this talk I will present studies in which we have used invasive and non-invasive electrophysiology and computational modelling in tasks involving artificial sequences and visual narratives to shed light into the computations and brain mechanism mediating segmentation and encoding of sequences with the larger goal of understanding the building blocks of our temporal experience and why time feels the way it does, e.g., how we can apprehend, feel, and marvel at the temporal structure of music.

Population coding and oscillatory subspace synchronization integrate context into actions

Randolph Helfrich¹

¹University Medical Center Tuebingen, Hertie Institute for Clinical Brain Research, Otfried-Mueller-Str. 27, 72076 Tuebingen, Germany

Contextual cues and prior evidence guide human goal-directed behavior. The neurophysiological mechanisms that implement contextual priors to guide subsequent actions remain undefined. We demonstrate that increasing behavioral uncertainty introduces a shift from an oscillatory to a continuous processing mode in human prefrontal cortex. At the population level oscillatory and continuous dynamics reflect dissociable signatures supporting distinct aspects of encoding, transmission and execution of context-dependent action plans. Prefrontal population activity encodes predictive context and action plans in serially unfolding orthogonal subspaces, while prefrontal-motor theta oscillations synchronize action-encoding population subspaces to mediate the transfer of action plans. Collectively, our results reveal how two key features of large-scale population activity, namely continuous population trajectories and oscillatory synchrony, operate in concert to guide context-dependent human behavior.

Dissociable mechanisms for “what” and “when” predictions in the human brain

Caspar Martin Schwiedrzik¹

¹European Neuroscience Institute Goettingen, Neural Circuits and Cognition Lab, Grisebachstrasse 5, 37077 Goettingen, Germany

²German Primate Center - Leibniz Institute for Primate Research, Perception and Plasticity Group, Kellnerweg 4, 37077 Goettingen, Germany

Our environment contains statistical structure at various scales. This offers rich opportunity for the brain to exploit this structure for efficient ways to code and process information, and ultimately to improve perception. For example, theories that pose perception as an inference process suggest that previous experience enables making predictions about upcoming events and testing them against actual sensory inputs. However, the precise neural mechanisms underlying perceptual inference remain a matter of debate. I will present data from intracranial electrophysiology in humans that address the question whether predictions about different stimulus features are implemented by different neural mechanisms, and how deviations from predictions, so-called prediction errors, are computed. To address these questions, we manipulated the predictability of the contents (“what”) and timing (“when”) of auditory stimuli during a categorization task. We recorded neural activity with subdural and depth electrodes during invasive monitoring for epilepsy surgery in patients with pharmacologically intractable epilepsy. In addition, we recorded neural activity with laminar resolution from the superior temporal gyrus (STG) in a subset of the patients. This allowed us to address the mechanisms of predictive processing at different spatial scales, from the level of brain networks down to individual cortical layers. We find dissociable neural mechanisms of predicting the contents (“what”) and timing (“when”) of auditory stimuli. While some cortical regions (e.g., frontal and premotor) were preferentially modulated by either “what” or “when” predictability, the STG, a higher-order auditory region, integrated predictability of both stimulus features. “What” and “when” predictability were also linked to dissociable laminar activity in the STG, with distinct spatio-temporal profiles for the two stimulus features and their interaction. Comparing fulfilled to violated predictions further allowed us to localize the computation of prediction errors with layer precision. Together, these studies provide evidence for functional dissociations between different types of predictability at the level of brain areas and cortical microcircuits, and thus provide further insight into candidate mechanisms for perceptual inference directly in the human brain.

Distinct populations in human MTL combine items and contexts across temporal gaps

Marcel Bausch, Johannes Niediek¹, Thomas P. Reber^{1,2}, Sina Mackay¹, Jan Boström³,
Christian E. Elger¹, Florian Mormann¹

¹University Hospital Bonn, Department of Epileptology, Venusberg-Campus 1, 53127 Bonn, Germany

²UniDistance Suisse, Faculty of Psychology, Brig, Switzerland

³University Hospital Bonn, Department of Neurosurgery, 53127 Bonn, Germany

The medial temporal lobe (MTL), and particularly the hippocampus, have been proposed to represent items in context to guide the encoding and retrieval of memories. It is currently unclear, however, whether separate or conjunctive (overlapping) representations of content and context contribute to the context-dependent processing of multiple memories involving the same content in humans. We devised a picture comparison task in which contextual questions were to be associated with two subsequent pictures for adequate contextual comparisons of picture contents. Analyzing 3127 neurons recorded from 17 neurosurgical patients, we found that mostly separate populations of visual stimulus-modulated neurons (N = 601) and context-modulated neurons (N = 200) combine representations of pictures and contextual questions across temporal gaps. While the large majority of stimulus neurons were invariant to context (88%) and most context neurons were invariant to stimulus (64%), a small but significant fraction of stimulus neurons represented both (12%) or even specific conjunctions of context and stimulus (5%), particularly in hippocampus (10%). During late picture presentations when questions and picture contents became task-relevant, context neurons encoded associated context, stimulus neurons encoded associated picture contents and contextual question activity was re-instantiated. Overall, stimulus and context neurons contribute to the context-dependent processing of stimuli via re-instatement of associated stimulus-contexts. Their co-activation could both support memory of stimuli in their respective context and further specify processing of contents according to context. Stimulus and context neurons generalized across the respective other dimension and therefore appear well-suited to contribute to flexible decision making by either dynamically broadening or constraining memories through re-instatement or co-activation. Conjunctive representations of stimulus-context, on the other hand, demonstrate pattern separation in humans and potentially specify memories of particular items-in-context or their attributes.

Symposium

S36: Transformations of visual representation from the retina to the cortex

[S36-1](#) Retinal ganglion cell typology and projection patterns in the brain
Gregory William Schwartz

[S36-2](#) Nuances and Refinements of Efficient Coding Theories

[S36-3](#) Convergence of distinct visual streams in the mouse primary visual thalamus
Liang Liang, Yue Fei

[S36-4](#) Feedforward mechanisms of cross-orientation interactions
Lindsey Lorien Glickfeld

[S36-5](#) Experience drives the development of novel, reliable cortical sensory representations from endogenously structured networks
Sigrid Trägenap, David E. Whitney, David Fitzpatrick, Matthias Kaschube

Retinal ganglion cell typology and projection patterns in the brain

Gregory William Schwartz¹

¹Feinberg School of Medicine, Northwestern University, Departments of Ophthalmology and Neuroscience, Chicago, IL, USA

There are over 40 retinal ganglion cell (RGC) types in the mouse retina and likely similar numbers in other mammalian species, and they project to over 50 distinct regions in the brain. I will discuss my lab's efforts to complete the catalog of mouse RGCs using an approach that unifies functional, morphological, and molecular measurements from the same cells. I will also talk about our recent, unpublished efforts to track RGCs axons into the brain to discover the logic of the projection patterns of each RGC type.

Nuances and Refinements of Efficient Coding Theories

¹Institute of Science and Technology Austria, Theoretical Biophysics and Neuroscience, Am Campus 1, 3400 Klosterneuburg, Austria

Theoretical understanding of early sensory areas such as the retina or the optic nerve has been long shaped by ideas from information theory and signal processing. These approaches grounded in engineering seem to provide a good candidate framework for understanding how sensory signals are first registered, represented and then efficiently conveyed to the central brain. Some theories seem however to be less well posed to explain and characterize computations deeper in the brain, where factors such as task-relevance and internal state strongly influence sensory representations.

In this talk I will discuss how we can simultaneously rely on existing theories of sensory computations to gain new insights into organization of sensory periphery, and how these theories can be expanded to account for phenomena in higher sensory areas. First, I will show how the established framework of efficient coding can still surprise us by revealing new aspects of the large-scale organization of the retina. Second, I will discuss how efficient coding approaches can be extended to account for adaptive internal computations such as dynamic attentional modulation in the primary visual cortex.

Convergence of distinct visual streams in the mouse primary visual thalamus

Liang Liang¹, Yue Fei¹

¹Yale University, Neuroscience, PO. Box 208001, 06520 New Haven, USA

The dorsal lateral geniculate nucleus (dLGN) of the thalamus routes visual signals from the eye to the visual cortex and provides critical support for conscious visual sensation. Rather than being a simple relay station, a growing body of evidence is revealing that the mouse dLGN plays an active role in shaping visual information flow to the cortex by selectively converging and integrating diverse streams of inputs. Studies of retinal inputs to the dLGN have provided rich knowledge about the organization and development of neural circuits for mammalian species. However, much less is known about the non-retinal inputs although they contribute ~90% of total inputs to the dLGN. How the visual and behavioral state information conveyed by non-retinal inputs combines with information from the retina to impact thalamic visual processing remains a topic of great experimental and theoretical interest. The midbrain superior colliculus sends a highly conserved projection into the dLGN. The colliculogeniculate axons resemble retinal axons in several synaptic properties, including targeting proximal dendrites of thalamocortical neurons and providing strong glutamatergic inputs. The prominent characteristics of 'driver' inputs and the conservation across mammals suggest important roles of this projection in visual processing. We determine whether the colliculogeniculate axons coordinate with retinal axons at multiple levels to reinforce select channels of visual information in dLGN neurons. Our results will reveal rules for functional convergence between retinal and collicular inputs and demonstrate how they act in concert or in competition to sculpt thalamic visual computation. Our findings will also contribute to the understanding of how afferent visual signals are transformed into visual feature selectivity in the dLGN and how behavioral states impact this process, providing the foundation for the understanding and treatment of neurological disorders involving improper neural circuit connectivity and signal integration.

Feedforward mechanisms of cross-orientation interactions

Lindsey Lorien Glickfeld¹

¹Duke University, Neurobiology, 311 Research Drive, Bryan Research Building Room 457, 27710 Durham, USA

Sensory neurons are modulated by context. For example, in mouse primary visual cortex (V1), neuronal responses to stimuli of the preferred orientation are modulated by the presence of superimposed orientations ("plaids"). Previous work in the cat visual cortex has demonstrated that such cross-orientation suppression is due to non-linearities, including contrast saturation and spike rectification, in the feedforward pathway. However, recent work in rodents and non-human primates have found more diverse effects of cross-orientation interactions; some neurons are suppressed, while others have larger responses to a plaid than its components. We investigated whether this diversity could be explained by the same unified feedforward circuit mechanism by using a combination of calcium imaging, intracellular recordings and computational models. We find that both facilitation and suppression are maintained during suppression of cortical activity, arguing against cortical mechanisms. Instead, the heterogeneity of plaid responses is explained by an interaction between stimulus geometry and orientation tuning. Highly selective neurons are uniformly suppressed by plaids, whereas the effects in weakly selective neurons depend on the spatial configuration of the stimulus, transitioning systematically between suppression and facilitation. Thus, the diverse responses emerge as a consequence of the spatial structure of feedforward inputs, with no need to invoke cortical interactions. Moreover, we find that these same non-linearities can explain the emergence of pattern selective neurons that have been observed in rodent V1. Neurons are more likely to undergo suppression of their preferred direction and facilitation of oblique directions when presented with a plaid, leading to pattern selective tuning. However, consistent with this being due to the interaction of stimulus geometry with the receptive field, changes to the spatial organization of the stimulus disrupts pattern encoding. Thus, our simple feedforward model can explain both the diversity of cross-orientation interactions as well as pattern encoding in mouse V1.

Experience drives the development of novel, reliable cortical sensory representations from endogenously structured networks

Sigrid Trägenap, David E. Whitney², David Fitzpatrick², Matthias Kaschube¹

¹Frankfurt Institute of Advanced Studies, AG Kaschube, Ruth-Moufang Straße 1, 60438 Frankfurt, Germany

²Max-Planck Florida Institute, Jupiter, USA

Cortical circuits embody remarkably reliable neural representations of sensory stimuli that are critical for perception and action. The fundamental structure of these network representations is thought to arise early in development prior to the onset of sensory experience. However, how these endogenously generated networks respond to the onset of sensory experience, and the extent to which they reorganize with experience remains unclear. Here we examine this 'nature-nurture transform' using chronic in vivo calcium imaging to probe the developmental emergence of the representation of orientation in visual cortex of the ferret, a species with a well-defined modular network of orientation-selective responses. At eye opening, visual stimulation of endogenous networks evokes robust modular patterns of cortical activity. However, these initial evoked activity patterns are strikingly different from those in experienced animals, exhibiting a high degree of variability both within and across trials that severely limits stimulus discriminability. In addition, visual experience is accompanied by a number of changes in the structure of the early evoked modular patterns including a reduction in dimensionality and a shift in the leading pattern dimensions indicating significant network reorganization. Moreover, these early evoked patterns and their changes are only partially predicted by the spontaneous modular activity patterns of the endogenous networks, and spontaneous network activity itself reorganizes considerably to align with the novel evoked patterns. Based on a computational network model, we propose that the initial evoked activity patterns reflect novel visual input that is only poorly aligned with the endogenous networks and that highly reliable visual representations emerge from a realignment of feedforward and recurrent networks that is optimal for these novel patterns of visually driven activity.

Poster Topics

- [T1](#) Stem cells, Neurogenesis and Gliogenesis
- [T2](#) Axon and Dendrite Development, Synaptogenesis
- [T3](#) Developmental Cell Death, Regeneration and Transplantation
- [T4](#) Neurotransmitters, Retrograde messengers and Cytokines
- [T5](#) G Protein-linked and other Receptors
- [T6](#) Ligand-gated, Voltage-dependent Ion Channels and Transporters
- [T7](#) Synaptic Transmission, Pre- and Postsynaptic organization
- [T8](#) Synaptic Plasticity, LTP, LTD
- [T9](#) Glia, Glia-Neuron Interactions
- [T10](#) Aging and Developmental Disorders
- [T11](#) Alzheimer's, Parkinson's and other Neurodegenerative Diseases
- [T12](#) Neuroimmunology, Inflammation and Neuroprotection
- [T13](#) Cognitive, Emotional, Behavioral State Disorders and Addiction
- [T14](#) Vision: Invertebrates
- [T15](#) Vision: Retina and Subcortical Pathways
- [T16](#) Vision: Striate and Extrastriate Cortex, Eye Movement and Visuomotor Processing
- [T17](#) Auditory Mechanoreceptors, Vestibular, Cochlea, Lateral Line and Active Sensing
- [T18](#) Auditory System: Subcortical and Cortical Processing
- [T19](#) Chemical Senses: Olfaction, Taste, Others

[T20](#) Somatosensation: Touch, Temperature, Proprioception, Nociception

[T21](#) Motor Systems

[T22](#) Homeostatic and Neuroendocrine Systems, Stress Response

[T23](#) Neural Networks and Rhythm Generators

[T24](#) Attention, Motivation, Emotion and Cognition

[T25](#) Learning and Memory

[T26](#) Computational Neuroscience

[T27](#) Techniques and Demonstrations

Poster Topic

T1: Stem cells, Neurogenesis and Gliogenesis

- [T1-1A](#) Analysis of the role of the human-specific gene *ZNF492* during neocortex development and evolution by genetic modification of human and chimpanzee cerebral organoids.
Lidiia Tynianskaia, Neringa Liutikaite, Wieland B. Huttner, Michael Heide
- [T1-2A](#) Assessing the functional role of niche astrocytes in regulation of adult hippocampal neurogenesis
Evangelia Masouti, Felix Beyer, Ruth Beckervordersandforth
- [T1-3A](#) Chromatin remodeling BAF complex dependent mechanisms in development of cortical interneurons
Xiaoyi Mao, Pauline Antonie Ulmke, Jochen F. Staiger, Tran Tuoc
- [T1-4A](#) Development of myelin in fetal and postnatal neocortex of the European wild boar, *Sus scrofa*.
Eric Sobierajski, German Lauer, Katrin Czubay, Hannah Grabietz, Christa Beemelmans, Christoph Beemelmans, Gundela Meyer, Petra Wahle
- [T1-5A](#) DOT1L confers cell-autonomous effects on developing cortical interneurons.
Marta Garcia Miralles, Arquimedes Cheffer, Ipek Akol, Tanja Vogel
- [T1-6A](#) *Dot1l* deletion in cortical glutamatergic progenitors impacts the proper development of mouse GABAergic interneurons
Arquimedes Cheffer, Marta Garcia-Miralles, Camila Fullio, Tanja Vogel
- [T1-7A](#) Using stem cells to model human corticogenesis in vivo
Omer Revah, Felicity Gore, Kevin W. Kelley, Jimena Andersen, Noriaki Sakai, Xiaoyu Chen, Min-Yin Li, Fikri Birey, Xiao Yang, Nay L. Saw, Samuel W. Baker, Neal D. Amin, Shravanti Kulkarni, Rachana Mudipalli, Bianxiao Cui, Seiji Nishino, Gerald A. Grant, Juliet K. Knowles, Mehrdad Shamloo, John R. Huguenard, Karl Deisseroth, Sergiu P. Pascal
- [T1-1B](#) Identification of cancer-associated fibroblast-like cells in a rat model of glioblastoma
Thibault Lootens, Christophe Mangodt, Bart Roman, Christian Stevens, Robrecht Raedt
- [T1-2B](#) Individual and combined functions of the human-specific genes *NBPF14* and *NOTCH2NLB* during neocortical development
Nesil Esiyok, Christiane Haffner, Wieland B. Huttner, Michael Heide
- [T1-3B](#) Inner-nuclear relocation of gene loci linked to developmental neural stem cell competence of *Drosophila* is dependent on nuclear β -actin activity

- [T1-4B](#) Investigating the effects of CNVs in the ADHD risk gene PARK2 on transcript and protein expression in iPSC-derived neural cells
Carolin Kurth , Rhiannon McNeill, Zora Schickardt, Sarah Kittel-Schneider
- [T1-5B](#) Label-free functional characterization of human brain organoids at single-cell resolution
Wei Gong
- [T1-6B](#) Modelling Tubulinopathies with Human Stem Cells
Thomas David Cushion, Romina Romaniello, David Anthony Keays
- [T1-1C](#) Molecular determinants of neocortical development
Elisa Pedersen, Ekaterina Epifanova, Paul Moritz Willecke, Marta Rosário
- [T1-2C](#) Novel SHH modulators and candidate modifier genes for congenital brain disorders – functional studies in mouse and human neuronal precursors
Gökce Nihan Yildirim, Tamrat Meshka Mamo, Izabela Kowalczyk , Annette Hammes
- [T1-3C](#) Role of DNA Topoisomerase II β in the Differentiation of Neural Stem Cells
Nina Trautwein, Melanie Grotz, Bodo Laube
- [T1-4C](#) Suggestion of general mechanisms and relationships between brain, pancreas and myocardium by application of different methods for assay in experimental models
Iskra Sainova
- [T1-5C](#) Studying the properties of human neural cells and networks using cultured brain organoid slices (cBOS)
Laura Petersilie, Stephanie Le, Karl W. Kafitz, Alessandro Prigione, Christine R. Rose
- [T1-6C](#) The role of Sox9 in regulating the neuron/glial switch of adult hippocampal neural stem cells

Felix Beyer, Anne Peter, Michael Wegner, Ruth Beckervordersandforth

Analysis of the role of the human-specific gene *ZNF492* during neocortex development and evolution by genetic modification of human and chimpanzee cerebral organoids.

Lidiia Tynianskaia¹, Neringa Liutikaite¹, Wieland B. Huttner², Michael Heide^{1,2}

¹ German Primate Center, Leibniz Institute for Primate Research, Kellnerweg 4, 37077 Göttingen, Germany.

² Max Planck Institute of Molecular Cell Biology and Genetics, Pfotenhauerstrasse 108, 01307 Dresden, Germany.

The neocortex, the evolutionary youngest part of the brain, which is unique to mammals and responsible for a variety of important functions, including higher cognitive abilities like speech and consciousness. This fascinatingly complex structure has undergone a massive increase in total size and gyrification grade (degree of folding) during the course of primate evolution. However, the factors underlying neocortical expansion remain largely elusive. Previous studies have indicated that the pool size and the behavior of cortical neural progenitor cells (cNPCs) during early development are defining factors of cortical morphology. In our research, we focus on the Zinc finger protein (ZNF) transcription factor family which has undergone an evolutionary expansion in primates. Previously, we identified one of these ZNFs, *ZNF492*, as a promising candidate for a potential key role in human neocortex expansion, as this gene exists only in humans (human-specific) and is specifically expressed in cNPCs. To analyze the role of *ZNF492* during human neocortex development and evolution, we made use of cerebral organoids which recapitulate key aspects of neocortical development. Due to this reason, they represent a perfect model for technically uncomplicated and ethically justifiable ape studies. Here, we first analyzed human *ZNF492* knock-out cerebral organoids and found that these organoids exhibit an abnormal ventricular zone morphology and a reduced number of mitotically active apical progenitors. Moreover, we established a fast and efficient approach to study ectopic expression of this gene in chimpanzee organoids. For this purpose, we combined microinjection of expression plasmids into ventricular-like structures of cerebral organoids with electroporation to allow precise targeting of distinct cell population inside a chimpanzee organoid. This allows us to study this human-specific gene in our closest living relative, the chimpanzee.

Assessing the functional role of niche astrocytes in regulation of adult hippocampal neurogenesis

Evangelia Masouti¹, Felix Beyer¹, Ruth Beckervordersandforth¹

¹Institute of Biochemistry, Friedrich-Alexander-Universität Erlangen-Nürnberg, Germany

Astrocytes are one of the most abundant cell types in the mammalian brain and play increasingly appreciated roles in supporting brain development and function. Astrocytes are major part of the adult hippocampal stem cell niche, and have been shown to control several steps of neurogenesis, from neural stem and precursor cells (NSPC) proliferation to differentiation and maturation of newborn neurons. Recent work proved astrocyte heterogeneity among different brain regions and suggested that astrocytes contribute region-specifically to brain homeostasis and neural plasticity. Interestingly, our lab identified intra-regional astrocyte diversity in the adult dentate gyrus (DG) of the hippocampus. Specifically, three major astrocyte subtypes can be distinguished by their morphology and sub-localization to specific DG structures. These astrocytes exhibit subtype-specific molecular properties and can be discriminated and prospectively isolated based on molecular marker gene expressions. We hypothesize that these morphological, positional and molecular differences account for different functional properties during the process of adult neurogenesis. To test this, one of my first goal is to establish an in vitro system to evaluate if NSPCs proliferation capacity as well as differentiation and maturation of progeny is affected by co-cultures with different astrocyte subtypes. Furthermore, this system allows to test factors that are differentially expressed by distinct astrocyte subtype for their function in the neurogenic process. These findings may help us to better understand the role of astrocyte in neurogenesis and adult hippocampal plasticity.

Chromatin remodeling BAF complex dependent mechanisms in development of cortical interneurons

Xiaoyi Mao¹, Pauline Antonie Ulmke², Jochen F. Staiger¹, Tran Tuoc²

¹Institute of Neuroanatomy, University Medical Center, Georg-August-University Göttingen, Göttingen, Germany

²Department of Human Genetics, Ruhr University Bochum, Bochum, Germany

Neurogenesis is a perfectly orchestrated spatiotemporal process. Cell divisions that either ensure self-renewal or bring about cell differentiation are carefully controlled by highly ordered gene expression programs. Chromatin regulators can affect gene expression outcomes by mediating chromatin state and DNA accessibility. Among these regulators, the BRG1/BRM associated factor (BAF) chromatin modifier family has a pivotal role in the maintenance of neural development. Yet previous studies only investigated its role in dorsal telencephalon development. So far, not much is known about its importance in the ventral aspect of the embryonic telencephalon, from which the cortical interneurons primarily derive. Here, we examined the phenotype of the BAF155cKO_Olig2-Cre and dcKO_Olig2-Cre mutant brains in which the function of BAF complex is either partially impaired by deleting BAF155 solely or completely abolished by deleting both BAF155 and BAF170 subunits in the mouse medial ganglionic eminence (MGE) interneuron progenitors with the Olig2-Cre driver. Our immunostaining results at E13.5 revealed that BAF155 and BAF170 are expressed both in mitotic and post-mitotic cells in MGE. Ablation of BAF155 and BAF170 results in a depletion of intermediate progenitor pool in the subventricular zone (SVZ) of MGE but seems to have no effect on cells in ventricular zone (VZ). A large number of cells in SVZ lose proliferative capacity and some undergo apoptosis, which leads to reduced generation of newborn cortical interneurons. However, for those cells which still maintain the ability to proliferate, the cell cycle progression appears unimpaired. BAF155cKO partially phenocopies dcKO with milder phenotype. Mechanistically, compared to E13.5 wildtype MGE, RNA-seq results from BAF155cKO and dcKO show similar dysfunctional transcriptional networks. Apoptotic signaling pathway-related genes and Wnt-signaling genes are significantly upregulated, whereas genes controlling chromosome division and neural development-related genes top the list of downregulated genes. Upregulated genes are enriched in VZ, while downregulated genes are enriched in SVZ/Mantle zone (MZ), displaying the same tendency in Nkx2.1 cKO MGE. CUT&RUN assay further identified the direct transcription factor targets of BAF complex, which provides a foundation for elucidating the genomic regulatory networks guiding the development of MGE-derived Interneurons.

Development of myelin in fetal and postnatal neocortex of the European wild boar, *Sus scrofa*.

Eric Sobierajski¹, German Lauer¹, Katrin Czubay¹, Hannah Grabietz¹, Christa Beemelmans², Christoph Beemelmans², Gundela Meyer³, Petra Wahle¹

¹Ruhr University Bochum, Faculty of Biology and Biotechnology, Developmental Neurobiology, 44801 Bochum, Germany

²Regionalverband Ruhr Grün, Forsthof Üfter Mark, Forsthausweg 306, 46514 Schermbeck, Germany

³Department of Basic Medical Science, Faculty of Medicine, University of La Laguna, 38200, Santa Cruz de Tenerife, Tenerife, Spain

The current knowledge of cortical development is largely based on rodents and primates, all of which are altricial nestlings. In this paper, aligned with preliminary studies, the pig was used to address myelination in a precocial animal. Here, we examined the onset and progression of myelin and oligodendrocyte (OL) development in the visual (VC) and somatosensory cortex (SC) of wild boar fetuses between E45 and P90. PDGFR α ;+ OL-progenitor cells were already detectable at E45 (~39 % of gestation) in the cortical intermediate zone. Quantification revealed a large increase of OL-progenitor cells in the intermediate zone/white matter to a peak at P5, accompanied by a massive increase in cortical volume. This was followed by a rapid decrease to P90. Detection with a variety of myelin relating proteins (MAG, MBP, PLP, Olig2) demonstrated that there are myelinated axon sheaths and mature OLs in the developing cortex as early as E70 (~61 % of gestation). The pattern of myelination at E100 is already comparable to the adult pattern. Surprisingly, there is a clear difference in the onset of myelination when comparing different cortex areas, here the VC and the SC. Thus, in the SC there is a detectable expression of the myelin-relevant proteins MBP and MAG as early as E80, whereas in the VC this was not detectable until E95. These results suggest that the process of myelination starts early prenatally in pig as compared to the better known postnatal myelination of small laboratory rodent cortex. Moreover, it rapidly accelerates to reach a near adult status shortly before birth.

DOT1L confers cell-autonomous effects on developing cortical interneurons.

Marta Garcia Miralles¹, Arquimedes Cheffer¹, Ipek Akol^{1,2}, Tanja Vogel^{1,3}

¹Institute of Anatomy and Cell Biology, Department of Molecular Embryology, Medical Faculty, University of Freiburg, Alberstraße 23, 79104 Freiburg, Germany

²Faculty of Biology, University of Freiburg, 79104 Freiburg, Germany

³Center for Basics in NeuroModulation (NeuroModul Basics), Medical Faculty, University of Freiburg, 79104 Freiburg, Germany

The cortical plate is composed of excitatory and inhibitory interneurons the latter of which originate in the ganglionic eminences. From their origin in the ventral telencephalon they migrate during embryonic development over large distance to reach their final destination in the cortical plate. DOT1L, a histone methyltransferase, is necessary for proper cortical plate development and layer distribution of glutamatergic neurons, however, its specific role on interneuron development has not been explored. Here, we demonstrate that DOT1L affects interneuron development in a cell-autonomous manner. Deletion of *Dot1l* in MGE-derived interneuron precursor cells results in an overall reduction and altered distribution of GABAergic interneurons in the cortical plate at postnatal day (P) 0. Furthermore, there is an altered proportion of GABAergic interneurons in the cortex and striatum at P21 with a significant decrease in the proportion of Parvalbumin interneurons. Altogether, our results indicate that DOT1L plays an important role on cortical interneuron development but the exact mechanism how DOT1L is regulating this process at the molecular level is under current investigation. To this aim, we are using RNA- and scATAC-sequencing analysis of the ventral telencephalon including the ganglionic eminences, at embryonic day 14.5 upon *Dot1l* deletion.

***Dot1l* deletion in cortical glutamatergic progenitors impacts the proper development of mouse GABAergic interneurons**

Arquimedes Cheffer¹, Marta Garcia-Miralles¹, Camila Fullio^{1,2}, Tanja Vogel^{1,3}

¹Institute for Anatomy and Cell Biology, Department of Molecular Embryology, Medical Faculty, University of Freiburg, 79104 Freiburg im Breisgau, Germany

² Faculty of Biology, University of Freiburg, 79104 Freiburg im Breisgau, Germany

³Center for Basics in NeuroModulation (NeuroModul Basics), Medical Faculty, University of Freiburg, 79104 Freiburg, Germany

The proper development of the cerebral cortex results from the processes of cellular proliferation, migration and differentiation, in which different types of cells, such as glutamatergic and GABAergic neurons, glia (astrocytes and oligodendrocytes) and microglia cells are generated. These processes are finely orchestrated by the very specific spatio-temporal expression of many different genes. In this context, the epigenetic control of gene expression plays a crucial role, as has been demonstrated by our work on the implications of the histone methyltransferase DOT1L in the development of the cerebral cortex. DOT1L is important for the maintenance of the progenitor pool and the adequate neuronal differentiation, since DOT1L insufficiency is associated with cell cycle exit and premature neuronal differentiation. Here we combined transcriptomic and proteomic analysis with histological stainings on *Emx^{Cre}Dot1l* conditional knockout (cKO) mice, where *Dot1l* is specifically deleted in cortical glutamatergic progenitors to investigate non-cell autonomous effects of such deletion on the GABAergic neurodevelopment. At the embryonic stage of cortical development, we observed reduced mRNA expression of GABAergic markers, for instance, *Sst*, *Npy*, *Calb2* and *Ache*, and GO term enrichment analysis showed that genes related to late neuronal maturation were overrepresented. The numbers of both medial ganglionic and caudal ganglionic eminence (MGE, CGE)-derived interneurons were increased in the cortex and striatum of DOT1L-deficient mice. Our transcriptomic and proteomic data revealed that the deletion of *Dot1l* results in the upregulation of genes encoding for chemokines and involved in the synthesis and interaction with extracellular matrix components. Additionally, overexpression of the axon guidance molecules SEMA3A and PLXNA4 was detected. These alterations might affect the migration and settlement of GABAergic interneurons in the cortex. Together, our data show that *Dot1l* deletion in cortical glutamatergic progenitors results in increased numbers of MGE- and CGE-derived GABAergic interneurons in the cortex and striatum of cKO mice through a mechanism that probably involves alterations in the composition of the extracellular matrix and increased expression of chemokines.

Using stem cells to model human corticogenesis in vivo

Omer Revah¹, Felicity Gore², Kevin W. Kelley¹, Jimena Andersen¹, Noriaki Sakai¹, Xiaoyu Chen¹, Min-Yin Li¹, Fikri Birey¹, Xiao Yang¹, Nay L. Saw³, Samuel W. Baker⁴, Neal D. Amin¹, Shravanti Kulkarni¹, Rachana Mudipalli², Bianxiao Cui⁵, Seiji Nishino¹, Gerald A. Grant⁶, Juliet K. Knowles⁷, Mehrdad Shamloo^{3,6}, John R. Huguenard⁷, Karl Deisseroth^{1,2,8}, Sergiu P. Pascal^{1,9}

¹Department of Psychiatry and Behavioral Sciences, Stanford University, Stanford, USA

²Department of Bioengineering, Stanford University, Stanford, USA

³Stanford Behavioral and Functional Neuroscience Laboratory, Wu Tsai Neurosciences Institute, Stanford University, Stanford, USA

⁴Department of Comparative Medicine, Stanford University, Stanford, USA

⁵Department of Chemistry, Stanford University, Stanford, USA

⁶Department of Neurosurgery, Stanford University, Stanford, USA

⁷Department of Neurology and Neurological Sciences, Stanford, USA

⁸Howard Hughes Medical Institute, Stanford University, Stanford, USA

⁹Stanford Brain Organogenesis, Wu Tsai Neurosciences Institute, Stanford University, Stanford, USA

Stem cell-derived human brain organoids represent a promising in vitro platform to model human brain disorders, but cultured organoids are missing some of the connectivity and specific microenvironment that exist in vivo. Here, using various methodologies we show that cortical organoids transplanted into the rat somatosensory cortex develop mature cell subtypes and integrate functionally with host circuits.

Identification of cancer-associated fibroblast-like cells in a rat model of glioblastoma

Thibault Lootens^{1,2}, Christophe Mangodt², Bart Roman², Christian Stevens², Robrecht Raedt¹

¹4BRAIN, Department of Head and Skin, Ghent University, Belgium

²SynBioC, Department of Green Chemistry and Technology, Ghent University, Belgium

Introduction:

Glioblastoma (GBM) is the most aggressive and most common malignant primary brain tumor, with a median overall survival of 14-16 months after diagnosis. There is an unmet need for alternative solutions, as therapeutic advances have been marginal over the past decades. Cancer-associated fibroblasts (CAFs) are considered important modulators of the tumor microenvironment (TME). In many cancer types, these spindle-shaped cells are known to enhance disease progression, augment stiffness of the tumor tissue, modulate therapy responses and drive angiogenesis, metastasis and invasion. Very recently, their presence has been confirmed in GBM patients, but their role within this complex TME remains elusive. This highlights the need for a suitable animal model to learn more about the biology of glioma-associated CAFs and to evaluate CAF-targeting therapies in GBM.

Methods:

Two male Fischer rats were inoculated with 20 000 F98 GBM cells in the right entorhinal cortex. Ten days post-inoculation, brain isolation and cryosectioning was performed, after which brain slices were stained with antibodies for CAF-markers FAP, TE-7, PDPN and alpha-SMA. As none of these markers are uniquely expressed by CAFs, double stainings for markers TE-7/FAP and TE-7/PDPN were performed, to allow for a more specific identification. To assess the percentage of alpha-SMA positive area, fifteen regions of interest ($9.0 \times 10^4 \mu\text{m}^2$) were selected per slice and analyzed using the ImageJ software. All slides were visualized by a 3DHISTECH Panoramic 250 Flash III digital slide scanner.

Results:

Cells (co-)expressing CAF markers were present in brain slices from the rat F98 GBM model. Spindle-shaped alpha-SMA expression (Figure 1A) was observed throughout the tumor core of all stained brain slices and was significantly upregulated compared to contralateral (normal) brain regions ($P < 0.001$). In both double stainings, spindle-shaped, co-expressing cells were identified as small groups of cells or individual cells. For the staining of CAF-markers TE-7/FAP, co-expressing cells were identified in three out of eight stained brain slices (Figure 1B), while co-expression of CAF-markers TE-7/PDPN was observed in all stainings. TE-7/PDPN-positive cells were mainly located inside the tumor, in the border region (Figure 1C).

Conclusion:

We provide the first indications for the presence of CAFs in the TME of the rat F98 GBM model, which is known to mimic the aggressiveness, histological appearance and lack of immunogenicity of human GBM. As these cells are hard to identify based on immunohistochemical stainings, these findings should be confirmed by single-cell characterization techniques such as flow cytometry or single-cell RNA-sequencing. If confirmed, this model can be a useful tool to unravel the functions of GBM CAFs and to evaluate the potential of future therapies targeting these cells.

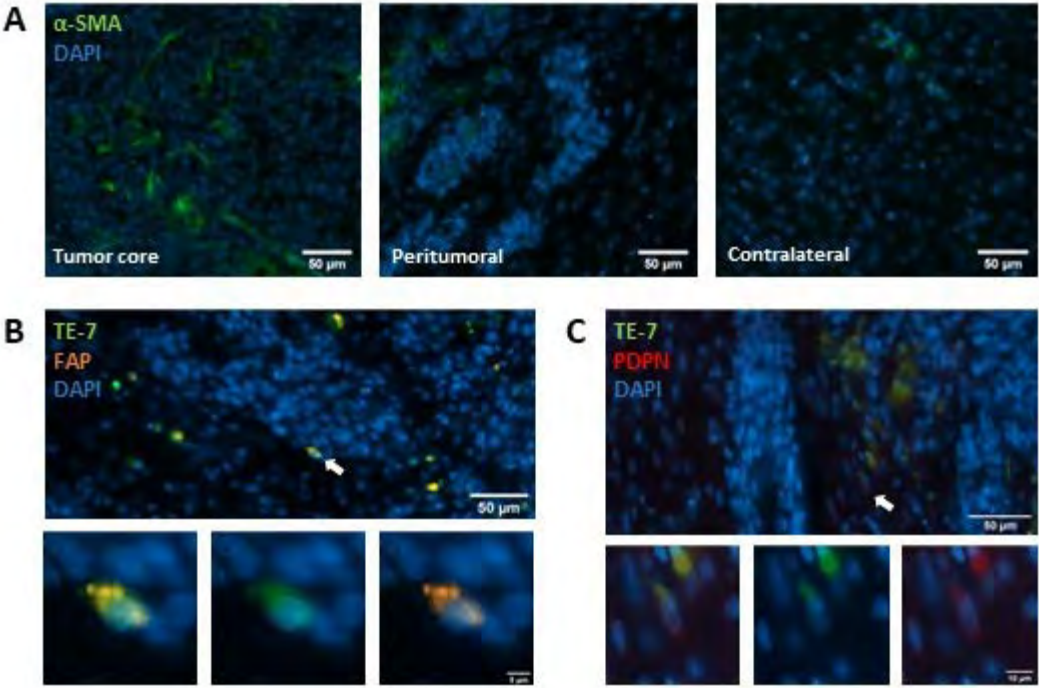

Figure 1: Immunofluorescent stainings of tumor brain tissue slices from the F98 rat glioblastoma model. (A) α -SMA expression (green) in the tumor core, peritumoral zone and contralateral zone. (B) TE-7 expression (green) and FAP expression (orange) in a subset of cells. (C) TE-7 expression (green) and PDPN expression (red) in a subset of cells.

Individual and combined functions of the human-specific genes *NBPF14* and *NOTCH2NLB* during neocortical development

Nesil Esiyok¹, Christiane Haffner², Wieland B. Huttner², Michael Heide^{1,2}

¹German Primate Center, Leibniz Institute for Primate Research, Kellnerweg 4, 37077 Göttingen, Germany

²Max Planck Institute of Molecular Cell Biology and Genetics, Pfotenhauerstrasse 108, 01307 Dresden, Germany

The neocortex is a fascinating brain structure, as it is the seat of human higher cognitive abilities. Different primate species show strong diversity in neocortex size and its degree of folding culminating in the large and strongly folded human neocortex. The basis for this is established during fetal neocortex development and is primarily controlled by genes that are specifically expressed in cortical neural stem and progenitor cells (cNPCs). Over the past few years, human-specific genes have received increasing attention as potential major contributors to human neocortex expansion and folding. In a previous study, we have identified 15 human-specific genes enriched in cNPCs. One of these genes, *NBPF14*, is of special interest, as it is a member of *NBPF* gene family, whose signature protein domain—the Olduvai domain—is associated with brain size. In addition to this, *NBPF14* is found to be co-expressed and co-evolved with another human-specific gene—*NOTCH2NLB*. Here we studied the individual and combined functions of *NBPF14* and *NOTCH2NLB* during neocortex development by microinjection of mRNA into single apical progenitors of mouse embryos. We found that (i) *NOTCH2NLB* mRNA alone leads to an increase in the number of apical progenitors; (ii) *NBPF14* mRNA alone leads to increased delamination of apical progenitors; and (iii) a mixture of *NOTCH2NLB* and *NBPF14* mRNA leads to an increase in the number of basal progenitors—one hallmark of human neocortex expansion and folding.

Inner-nuclear relocation of gene loci linked to developmental neural stem cell competence of *Drosophila* is dependent on nuclear β -actin activity

Joachim Urban¹, Prasad Chikte¹

¹Institute of Developmental Biology and Neurobiology, Johannes Gutenberg University Mainz, Department of Biology, Hanns-Dieter-Hüscher-Weg 15, 55128 Mainz, Germany

Neural stem cells produce specific cell types in a time-dependent manner passing through different competence windows. However, how these competence windows are regulated is largely unknown. In neural stem cells (neuroblasts) of *Drosophila* the closure of a certain competence window is correlated with an innernuclear relocation of genes which are supposed to get transcriptionally silenced. However, nothing is known about the mechanisms leading to this chromatin rearrangements. We now found strong evidence that nuclear β -actin is involved in this process. This has been deduced from the analysis of different mutants with defects in genes involved in the regulation of nuclear-cytoplasmic shuttling of β -actin as well as of overexpression experiments using different variants of β -actin linked to a nuclear localization signal. Based on these results we propose that the nuclear concentration of actin might be involved in the regulation of the length of competence windows in *Drosophila* neuroblasts.

Investigating the effects of CNVs in the ADHD risk gene *PARK2* on transcript and protein expression in iPSC-derived neural cells

Carolin Kurth¹, Rhiannon McNeill¹, Zora Schickardt¹, Sarah Kittel-Schneider¹

¹Department of Psychiatry, Psychotherapy and Psychosomatic Medicine, University Hospital, University of Würzburg, 97080 Würzburg, Germany

Attention-deficit/hyperactivity disorder (ADHD) is one of the most common mental disorders affecting not only children but also adults¹. It is a chronic neurodevelopmental disorder characterized by inattention, hyperactivity and impulsivity¹. However, its etiology and pathophysiology remain elusive, partially due to the inaccessibility of patients' brain neurons². However, cellular models representing the clinical features of ADHD might help to circumvent this issue. Therefore, we have generated human induced pluripotent stem cells (hiPSCs)³ from healthy controls and ADHD patients, and established a model of cortical neuron differentiation in order to investigate the etiology of ADHD. As ADHD and other neurodevelopmental disorders are of high heritability, several risk genes have already been identified. A rare genetic variant which has been associated with the risk of the disorder is located in the *parkinson protein 2 gene (PARK2)*, which encodes an E3 ubiquitin ligase and whose main role is among others to control mitochondrial quality⁴. Previous studies have shown a significantly higher prevalence of rare CNVs in *PARK2* in ADHD patients than in controls⁵. The pathophysiological role of *PARK2* CNVs in the development of ADHD is still largely unknown. Previous own research hinted at reduced *PARK2* gene and protein expression, as well as mitochondrial dysfunction and energy metabolism disturbances in hiPSC derived dopaminergic neurons^{6,7}, but those results need to be replicated in another neuronal model and investigated in more depth. In this study, hiPSCs will be differentiated into neural precursor cells (NPCs), i.e., 3 healthy controls and 4 ADHD patients with *PARK2* CNVs, and standard characterization checks will be performed (e.g., *SOX2* and *PAX6* expression) before differentiating NPCs into cortical neurons. *PARK2* expression will be determined for these developmental stages using quantitative Polymerase Chain Reaction (qPCR), Western Blot and Immunofluorescence. Lastly, we will compare *PARK2* expression between wildtype and CNV carriers, to determine whether CNVs in the *PARK2* gene may affect its expression. Altered expression could result in compromised functionality, and therefore act as a possible ADHD pathomechanism.

1. American Psychiatric Association. (American Psychiatric Association, 2013)

2. Tong, J., Lee, K. M., Liu, X., Nefzger, C. M., Vijayakumar, P., Hawi, Z., Pang, K. C., Parish, C. L., Polo, J. M., & Bellgrove, M. A. (2019). Generation of four iPSC lines from peripheral blood mononuclear cells (PBMCs) of an attention deficit hyperactivity disorder (ADHD) individual and a healthy sibling in an Australia-Caucasian family. *Stem cell research*, 34, 101353

3. Palladino, V. S., Subrata, N. O. C., Geburtig-Chiocchetti, A., McNeill, R., Hoffmann, P., Reif, A., & Kittel-Schneider, S. (2018). Generation of human induced pluripotent stem cell lines (hiPSC) from one bipolar disorder patient carrier of a DGKH risk haplotype and one non-risk-variant-carrier bipolar disorder patient. *Stem cell research*, 32, 104-109.

4. Sarraf, S. A., Raman, M., Guarani-Pereira, V., Sowa, M. E., Huttlin, E. L., Gygi, S. P., & Harper, J. W. (2013). Landscape of the PARKIN-dependent ubiquitylome in response to mitochondrial depolarization. *Nature*, 496(7445), 372-376.
5. Jarick, I., Volckmar, A. L., Pütter, C., Pechlivanis, S., Nguyen, T. T., Dauvermann, M. R., ... & Hinney, A. (2014). Genome-wide analysis of rare copy number variations reveals PARK2 as a candidate gene for attention-deficit/hyperactivity disorder. *Molecular psychiatry*, 19(1), 115-121.
6. Radtke, F., Palladino, V. S., McNeill, R. V., Chiocchetti, A. G., Haslinger, D., Leyh, M., ... & Kittel-Schneider, S. (2022). ADHD-associated PARK2 copy number variants: A pilot study on gene expression and effects of supplementary deprivation in patient-derived cell lines. *American Journal of Medical Genetics Part B: Neuropsychiatric Genetics*, 189(7-8), 257-270.
7. Palladino, V. S., Chiocchetti, A. G., Frank, L., Haslinger, D., McNeill, R., Radtke, F., ... & Kittel-Schneider, S. (2020). Energy metabolism disturbances in cell models of PARK2 CNV carriers with ADHD. *Journal of clinical medicine*, 9(12), 4092.

Label-free functional characterization of human brain organoids at single-cell resolution

Wei Gong¹

¹MaxWell Biosystems AG, R&D department, Albisriederstrasse 253, 8047 Zurich, Switzerland

Aim

Three-dimensional brain organoids are self-organizing in vitro models that recapitulate fundamental aspects of human brain development. Thus, brain organoids are becoming widely used to study neuronal development and investigate mechanisms of progressive neurological disorders such as Alzheimer's disease and Parkinson's disease. The ability to measure the electrical activity of human brain organoids in real time, long-term and label-free can provide much needed insights into the complexity of the neuronal networks. High-density microelectrode arrays (HD-MEAs) provide unprecedented means for non-invasive high-content electrical imaging and can be used to acquire real time measurements from neural organoids.

Methods

In this study, a HD-MEA platform featuring 26,400 electrodes per well (MaxWell Biosystems AG, Switzerland) was used to capture spontaneous spike activity and fast propagating action potentials in organoids at different scales, ranging from network through single-neuron to subcellular features.

Results

Metrics, such as firing rate, spike amplitude, network burst shape as well as synchronicity, were extrapolated in a high throughput manner. Furthermore, at the subcellular level, we tracked the propagating action potentials across axonal branches to compute and characterize the conduction velocity across multiple neurons within a network.

Conclusions

Our HD-MEA platforms and the extracted parameters highlighted in this study provide a powerful user-friendly approach for disease modelling and compound testing in-vitro.

Modelling Tubulinopathies with Human Stem Cells

Thomas David Cushion¹, Romina Romaniello², David Anthony Keays³

¹ Dept of Physiology, Development and Neuroscience, University of Cambridge, UK

² IRCCS Eugenio Medea, Bosisio Parini, Italy

³ Sensory and Developmental Neuroscience, Faculty of Biology, Ludwig-Maximilians-Universität-München, Germany

Microtubules and their constituents, alpha- and beta-tubulins, are critical to the three major stages of vertebrate brain development: neurogenesis, neuronal migration, and neuronal differentiation. Mutations in *TUBB2B*, which encodes for a beta-tubulin, are associated with severe malformations of the cerebral cortex. Different *TUBB2B* variants give rise to a spectrum of malformations, however, the specific cellular mechanisms underlying each are poorly understood.

TUBB2B is expressed highly throughout brain development in a range of cell types including both neurons and progenitors. In humans, *TUBB2B* is particularly enriched in outer radial glia, a specialised progenitor class abundant in primates and thought to contribute to the cortical expansion and folding characteristic to the brains of higher mammals. We hypothesise that *TUBB2B* variants act by altering microtubule assembly, stability and/or dynamics which, in turn, perturb neuronal production and/or positioning during brain development. As outer radial glia are scarce in rodents, we aim to model *TUBB2B* mutations using advanced human stem cell-based approaches.

We have obtained skin fibroblasts or peripheral blood mononuclear cells from individuals carrying *TUBB2B* mutations presenting with different cortical malformations (e.g., microcephaly, lissencephaly, polymicrogyria and schizencephaly). These have been reprogrammed to induced pluripotent stem cells (iPSCs) and, using CRISPR/Cas9, we have repaired patient mutations to wild type to generate isogenic controls. We differentiate mutant and control iPSCs into 2D neuronal cultures to interrogate the effects of *TUBB2B* variants on microtubule function. Subsequently, we generate mutant and wild type cerebral organoids; self-organising 3D neuronal cultures that recapitulate aspects of human brain development. Using immunohistochemistry and advanced microscopy, we aim to elucidate the human-specific effects of *TUBB2B* variants on neuronal proliferation, migration and cortical organisation underlying cortical malformation phenotypes.

Molecular determinants of neocortical development

Elisa Pedersen¹, Ekaterina Epifanova¹, Paul Moritz Willecke¹, Marta Rosário¹

¹Institute of Cell Biology and Neurobiology, Charité - Universitätsmedizin Berlin, D-10117, Berlin, Germany.

The mammalian neocortex mediates higher cognitive functions. It is organized into six layers of excitatory neurons with distinct molecular and functional characteristics. The laminar structure of the cortex is essential for its function and is achieved by coordinated and tightly regulated molecular events such as cell proliferation, migration, and branching. Ubiquitination is a post translational modification that regulates protein stability and function. Over the past years, evidence for the importance of E3 ubiquitin ligases, the enzymes responsible for the catalysis step in ubiquitination, in corticogenesis has emerged, with several members being associated with neurodevelopmental disorders. The Deltex family of E3 ubiquitin ligases is poorly studied in the brain. However, in a screen performed in our lab, we have implicated the family in the regulation of neocortical development. Here, we address the function of the Deltex family member, DTX4, in the mouse brain and show that it is strongly expressed in the neocortex during development. Furthermore, we can show that disturbance of DTX4 expression results in cortical malformations, which we have further analyzed. We are currently addressing the cellular and signaling defects underlying the defects observed. All in all, we show that the ubiquitin ligase DTX4 is a novel regulator of corticogenesis in the mouse.

Novel SHH modulators and candidate modifier genes for congenital brain disorders – functional studies in mouse and human neuronal precursors

Gökce Nihan Yildirim¹, Tamrat Meshka Mamo¹, Izabela Kowalczyk¹, Annette Hammes¹

¹Max Delbrück Center for Molecular Medicine (MDC) in the Helmholtz Association, Berlin, Germany

Background: Patients carrying pathogenic gene variants encoding factors linked to the Sonic Hedgehog (SHH) signaling pathway suffer from severe congenital brain malformations including holoprosencephaly (HPE). A poorly understood feature of these common anomalies is highly variable penetrance, even among family members carrying the same mutation. Modifier genes - genetic variants that can affect the phenotypic outcome of the primary disease-causing gene - contribute to this variability within pedigrees. Modifier genes can confer resilience or susceptibility to a disease but are difficult to identify in humans. Studying mouse models of human congenital disorders can be instrumental in the identification of genes, that powerfully modulate SHH signaling pathway capacity and ultimately the penetrance of genetic disturbances. In particular, transcriptome sequencing as an emerging additional tool for genetic diagnosis of congenital disorders such as HPE can be instrumental in finding disease relevant candidate modifier genes.

Results: To identify candidate modifier genes for congenital disorders of the brain, we used mouse models of HPE with genetic ablation of the endocytic receptor LRP2 (LDL receptor related protein 2, also known as megalin), a coreceptor for SHH. *Lrp2*^{-/-} mutants of the inbred strain C57BL/6N show a fully penetrant HPE phenotype caused by impaired SHH signaling in the forebrain neuroepithelial stem cells. Strikingly, the phenotype was fully rescued in *Lrp2*^{-/-} mutants on the FVB/N strain background. Through complex transcriptome comparisons and filtering analyses, we identified a number of differentially expressed genes that are regulated in a genotype-independent, but strain specific manner and could therefore be classified as candidate modifier genes. Functional analyses revealed that the highest regulated genes, *Ulk4* (unc-51 like kinase 4) and *Pttg1* (pituitary tumor-transforming gene 1 protein, also known as securin) are novel positive regulators of the SHH signaling pathway. Further, we identified ULK4 and PTTG1 as components of primary cilia where they localize to the periciliary compartment and the ciliary shaft in a microtubule associated manner (Mecklenburg et al., 2021). Our recent results in mouse primary neuroepithelial cells showed that strain specific differences in the expression levels of *Ulk4* and *Pttg1* correlate with differences in primary cilia morphology and function. Knockdown of ULK4 or PTTG1 resulted in altered average cilia length and deficient Smoothed trafficking to the cilia shaft in NIH-3T3 cells. We also verified the periciliary localization of PTTG1 in human neuronal precursors (NPCs) derived from induced pluripotent stem cells (iPSCs). These results support our hypothesis that PTTG1, a known regulator of sister chromatid separation, is not degraded after cytokinesis as previously assumed, but instead plays a role in interphase during ciliogenesis and ciliary signaling pathways, which is relevant to a wide range of diseases (i.e., ciliopathies). Moreover, we detected PTTG1 in postmitotic differentiated neurons derived from hiPSCs decorating microtubules in neurites in a distinct pattern.

Conclusions: *Pttg1* is a novel candidate modifier gene that modulates SHH signaling capacity. Identification of genes that strongly modulate signaling pathway capacity and render the pathway more resilient to perturbation is relevant to understand the variability in human congenital disorders.

Role of DNA Topoisomerase II β in the Differentiation of Neural Stem Cells

Nina Trautwein¹, Melanie Grotz¹, Bodo Laube¹

¹Neurophysiology and Neurosensory Systems, Technische Universität Darmstadt, Schnittspahnstr. 3, 64287 Darmstadt, Germany

Neurogenesis describes the generation of neurons from tripotent neural stem cells (NSCs), with neuronal differentiation occurring through spatiotemporal gene expression patterns. Recent studies show that neuronal excitation through activation of NMDA receptors controls the activity of topoisomerase II β (Top2b) and consequently the expression of immediate early genes (IEGs), genes that also play an important role in neuronal differentiation. Type II topoisomerases basically untangle DNA by generating transient double-strand breaks followed by religation, and are therefore essential for the resolution of topological tensions that also occur during transcription. During neuronal differentiation to postmitotic neurons, a switch in Top2 α to Top2 β expression seems to occur in vitro and in vivo. Knockout of Top2b in mice leads to perinatal death and the role of Top2b in cellular neuronal development is not understood. Since in the course of differentiation into neurons obviously NMDAR-mediated neuronal activity and thus Top2b activation is important for differential gene expression and integration of new neurons into neuronal networks, we investigate the influence of Top2b activation on neuronal differentiation in vitro using the murine J1 neural stem cell model system. The differentiation of these NSCs into neurons, astrocytes as well as oligodendrocytes has been established by appropriate differentiation protocols. This allows us to investigate the phase-specific role of Top2b in differentiation. Examination of Top2b expression levels during differentiation by Western blot and RT-qPCR reveals a phase-specific change in expression with an increase during the maturation phase of the new neurons. Using a Top2b-specific inhibitor (ICRF-193) that both inhibits Top2b activity and leads to a transient downregulation of Top2b at the protein level, we investigate the effects of a phase-specific absence of Top2b. Immunofluorescence staining is used to examine the impact of Top2b absence on neuronal network development in vitro. Possible effects on functionality, such as spontaneous activity or synapse distribution, will be further addressed.

Suggestion of general mechanisms and relationships between brain, pancreas and myocardium by application of different methods for assay in experimental models

Iskra Sainova

¹Bulgarian Academy of Sciences (BAS), Bulgarian Academy of Sciences (BAS), "Hemus" Street, Bl. 61, 1574 Sofia, Bulgaria

As two key molecules, participating in different intra- and extra-cellular inter-molecular interactions have been characterized tri-peptide Glutathione (GSH), (known as anti-oxidant, immuno-modulator, cardioprotector, anti-ageing and anti-malignant substance), as well as the hormone-like protein Secretagogen (SCGN) (proved as tumor suppressor, neuroprotector, endocrine regulator and anti-diabetic agent). Total lysates from rodent brain, pancreas and myocardium were prepared and separated into three parts of probes. The first part was presented by the control probes, eventually containing the full composition of molecules for each respective anatomic organ. In the second part of probes, the total lysate from each organ was passed through GSH-agarose column, for selection of molecules, possessing affinity to GSH tri-peptide. In the third part of probes, the total lysate from each anatomic organ was mixed with a total lysate from in vitro-incubated cells, containing additionally-inserted copy of gene scgn plus GST-tag by transfection with appropriate DNA-vectors, and the so prepared lysate mixtures were then passed through GSH-agarose columns for selection of molecules, possessing affinity to protein SCGN. In all cases, the presence and levels of GM3 ganglioside and anti-GM3 antibodies were assessed by Enzyme-Linked Immuno-Sorbent Assay (ELISA). According to the results obtained, differences in the levels of GM3 ganglioside and anti-GM3 antibodies between the different samples of the myocardium lysate were not established, compared with the differences between the respective samples of the lysates from brain and pancreas. Additionally, in most of the cases, the titers of GM3 ganglioside and anti-GM3 antibodies in the myocardium lysate samples were significantly lower than in the respective samples of the lysates from brain and pancreas. Deviations were noted in the titers of anti-GM3 antibodies in dilution 1:200 of all samples of the myocardium lysate, which were very near to the levels in the respective samples of the lysates from brain and pancreas in the same dilution, compared with the significant differences in lower dilutions probably due to the presence of many other molecules, as well as in higher dilutions probably due to the insufficient amounts of the respective molecules of interest. One of the explanations of these data was that unlike of the whole brain and pancreas, protein SCGN is specific only for the neuronal components of the myocardium, and probably ganglioside GM3 influences inter-molecular interactions with participation of this protein in the neuronal components, but not in the cardiomyocytes. In opposite, tri-peptide GSH is more specific for the cardiomyocytes, and probably ganglioside GM3 influences inter-molecular interactions with participation of this tri-peptide mainly in the cardiomyocytes and less - in the neuronal components of the myocardium. However, probably the amounts of molecules, regulating these inter-molecular processes in the separate parts of the myocardium are approximately equal. Taking in consideration the proved existence of each ganglioside besides in free form, also in various bound forms with different molecules depending of the respective type and functional status, the so proposed activated status was confirmed by the observed signs of increased activity in both cardiomyocytes and neuro-filaments by light microscopy assay of fixed Hematoxyllin/Eosin stained fixed histological samples of the three anatomic organs. Furthermore, in the three organs was noted a possibility for production of immunoglobulins/antibodies. These results suggested a possibility about production of such molecules by non-lymphoid types of cells, tissues and organs. However,

because the so produced antibodies are out of the germinative centers in the specialized lymphoid tissues and organs, control in their functions is very important, for prevent of eventual chronic inflammation processes, which could lead to malignant transformations or to degenerative changes. In this relation, namely the role of small ions and molecules as gangliosides is pivotal. Gangliosides are complex glycosphingolipids, which participate in the control of different intra- and extra-cellular inter-molecular interactions, on cellular, tissue, organ and organism levels. In the last years, the anti-malignant, cardioprotective, neuroprotective and anti-diabetic properties of ganglioside GM3 in particular have been proved

Studying the properties of human neural cells and networks using cultured brain organoid slices (cBOS)

Laura Petersilie¹, Stephanie Le², Karl W. Kafitz¹, Alessandro Prigione², Christine R. Rose¹

¹Heinrich Heine University Duesseldorf, Institute of Neurobiology, Universitaetsstraße 1, 40225 Duesseldorf, Germany

²Heinrich Heine University Duesseldorf, Department of General Pediatrics, Neonatology and Pediatric Cardiology, Medical Faculty, Universitaetsstraße 1, 40225 Duesseldorf, Germany

In neuroscience research, rodents are a main model system to study the brain and its functions. As it is sometimes challenging to translate findings to the human brain, human model systems are needed to overcome this difficulty. A promising new strategy are 3D brain organoids, derived from human induced pluripotent stem cells (Le et al., J Vis Exp., 2021). Brain organoids usually mimic an early developmental stage of the brain and the differentiation and maturation of cells require a long-term cultivation. This period of time is, however, limited by the development of a necrotic core, which arises due to insufficient delivery of oxygen and nutrients to deeper regions in growing organoids. To overcome this, the generation of organotypic slice cultures at the air-liquid interface (ALI), derived from brain organoids, was recently introduced (Giandomenico et al., Nat Neurosci., 2019).

Here, we adopted and refined this approach using 11 weeks-old cortical brain organoids, from which we generated slices that were subsequently cultured at the ALI for additional 5 weeks. To this end, we embedded several organoids in low-gelling temperature agar, used a vibratome to cut 300 µm slices and cultured them on membranes in a humidified incubator.

Immunohistochemistry was performed to analyze the cellular organization of cultured brain organoid slices. The stainings revealed the presence of mature neurons and (presumed) astrocytes, as judged by MAP2- and S100β-positive structures in fixed slices. MAP2-positive structures also indicated the formation of dendritic spines.

In addition, we were able to establish dynamic ion imaging in this preparation. Cells were loaded with the membrane-permeable form of the calcium (Ca^{2+}) indicator OGB-1. Wide field imaging demonstrated that cells exhibit spontaneous intracellular Ca^{2+} signals. Besides that, they showed a transient Ca^{2+} increase in response to the neurotransmitter glutamate indicating the expression of functional postsynaptic sites.

Overall, these results suggest that cultured brain organoid slices (cBOS) might be a powerful model system to study morphological and physiological properties of human brain cells, more precisely, of human neurons and glial cells in minimal networks.

Supported by the DFG (RU 2795 "Synapses under stress", RO 2327/13-2).

The role of Sox9 in regulating the neuron/glial switch of adult hippocampal neural stem cells

Felix Beyer¹, Anne Peter¹, Michael Wegner¹, Ruth Beckervordersandforth¹

¹Institute of Biochemistry, FAU Erlangen-Nürnberg, Erlangen, Germany

The dentate gyrus (DG) is a unique structure in the brain. Persisting adult neurogenesis by neural stem cells (NSCs) warrants an individual's ability to adapt to a changing environment. Besides neurogenesis, niche astrocytes contribute to the high level of plasticity in the DG. Adult NSCs generate neurons and astrocytes. Interestingly, our group revealed that the balance between neuro- and astrogenesis remains constant in the adult hippocampus. This suggests a mechanism that regulates the fate decision of adult NSCs. Which factors are responsible in controlling the neuron-to-astrocyte ratio? The transcription factor Sox9 emerged as a master-regulator of the neuron/glial switch during development (Klum et al., 2018) and governs astroglial fate of subventricular zone NSCs (Cheng et al, 2009).

To reveal mechanisms controlling neurogenesis versus astrogenesis in the adult DG, we use genetic mouse models to delete (Sox9ko) and overexpress Sox9 (Sox9oe) in adult hippocampal NSCs, respectively. Here, I observed an increase in astrogenesis at the expense of neurogenesis upon Sox9oe. Surprisingly, the majority of NSC descendants proved to be "hybrid cells" (simultaneously expressing neuronal DCX and astroglial S100 β) upon Sox9oe. In line, conditional Sox9ko in adult NSCs reduced newborn astrocyte numbers while neuroblast numbers did not change. In summary, Sox9 is involved in the neuron/glial switch in adult NSCs of the DG. Next, we will reveal downstream targets of Sox9 mediating pro-astroglial effects in NSCs. This will significantly promote our understanding of adult NSC behavior, which is a prerequisite to better understand glio- and neuropathological phenotypes.

Poster Topic

T2: Axon and Dendrite Development, Synaptogenesis

- [T2-1A](#) Cytoskeleton based local transport via myosins during synapse formation.
Sophie Marie Walter, Astrid Petzoldt
- [T2-2A](#) Development of distinct descending cortical pathways
Philipp Abe, Adrien Lavalley, Ilaria Morassut, Esther Klingler, Antonio Santinha, Randall Platt, Denis Jabaudon
- [T2-3A](#) Development of GABAergic synapses in the sensory cortex of early postnatal mice
Ahd Abusaada, Prof. Dr. Werner Kilb, Prof. Dr. Heiko Luhmann
- [T2-4A](#) Developmental competition ensures correct synapse numbers for motor circuit assembly and function
Lion Huthmacher, Selina Hilgert, Silvan Hürkey, Stefanie Ryglewski, Carsten Duch
- [T2-5A](#) Emergence of cortex-wide calcium dynamics during postnatal mouse development
Davide Warm
- [T2-6A](#) Flies in a centrifuge: Rewiring the brain with hyper-gravity
Felix Graf, P. Robin Hiesinger
- [T2-1B](#) Influence of developmental temperature on the wiring and variability of the *Drosophila* olfactory pathway
Pascal Züfle, Leticia Batista, Carlotta Martelli
- [T2-2B](#) Pharmacological modulation of the GluN2C/2D NMDA receptor subunit does not influence interneuron and pyramidal cell maturation in visual cortex OTC's
Lisa Marie Rennau, Leon Hoffmann, Ina Köhler, Petra Wahle
- [T2-3B](#) Robustness of Early Pattern Formation in the *Drosophila* Visual Map
Berna Melinda Nabavi, Charlotte B. Wit, Egemen Agi, P. Robin Hiesinger
- [T2-4B](#) Systematic functional analysis of Rab GTPases in neuronal development and maintenance
Ilsa-Maria Daumann, Friederike E. Kohrs, Hanna Stiedenroth, P. Robin Hiesinger
- [T2-5B](#) The cell surface protein Roughest mediates neurite branch competition during brain wiring
Abhishek Jayant Kulkarni, Thanh Thanh Tu Tran

- [T2-1C](#) The development of MC3R neurons, AgRP and POMC neuronal projections and the maintenance of intra-hypothalamic neuronal circuits.
Selma Yagoub
- [T2-2C](#) The role of MAST2 in neurodevelopment and disease
Alexandra Catalina Vilceanu, Maria Sergaki, Fernanda Martinez-Reza, Florian Walter, David Keays
- [T2-3C](#) Visual map formation without target-dependent guidance in *Drosophila*
Egemen Agi, Eric Reifstein, Charlotte Wit, Monika Kauer, Teresa Schneider, Max von Kleist, Peter Robin Hiesinger
- [T2-4C](#) Chrono-Anatomical Description of Dopaminergic Neurons during Metamorphosis in *Drosophila melanogaster*
Anne Sophie Oepen, Jiajun Zhang, Oren Schuldiner, Kei Ito, Thomas Riemensperger
- [T2-5C](#) Cyclase-associated protein 1 (CAP1) inhibits MRTF-SRF-dependent gene expression in the mouse brain
Sharof Khudayberdiev, Anika Heinze, Uwe Linne, Marco B Rust

Cytoskeleton based local transport via myosins during synapse formation.

Sophie Marie Walter¹, Astrid Petzoldt¹

¹Freie Universität Berlin, Institute of Biology, Chariteplatz 1, 10117 Berlin, Germany

Synapse formation and maintenance are the fundamental processes shaping synaptic circuits and thus controlling fundamental processes such as learning and memory or locomotion. The molecular processes underlying synaptogenesis are well investigated, however, how the presynaptic material is locally delivered and incorporated into the nascent or maturing presynapses is less well understood. Presynaptic proteins, including AZ scaffold-, synaptic vesicle (SV) proteins, release factors and voltage gated ion channels, traffic on presynaptic precursor vesicles (PV) along axonal microtubules (MT) from the neuronal soma, where they are assembled, to their sites of consumption, the synaptic terminals [1,2]. Robust synapse formation is determined by the amount and distribution of disposable protein, however the molecular mechanisms of local protein transport and delivery to the presynapse during early synapse seeding and later stabilization remain elusive. Here we investigate the requirement of cytoskeletal motor-proteins, specifically myosins, in this process. Myosins are motor-proteins processing along actin filaments to transport variable cargos [3]. An RNAi screen depleting unconventional myosins in the neuromuscular junctions (NMJs) of *Drosophila* larvae revealed several aberrant synapse formation phenotypes. By confocal and STED (stimulated emission depletion) microscopy and in-vivo combined with electrophysiological approaches we want to establish the function of candidate-myosins in cargo delivery, potentially stalling of transport vesicles at sites of consumption, to allow and thus control early steps of synapse formation, synapse seeding or later during synapse maturation and maintenance. The local cytoskeleton at the presynapse itself could also be shaped either by the myosins themselves or be used to direct and regulate myosin delivery routes. The developing *Drosophila* larval neuromuscular junction offers a perfect model for quantitative description and genetic manipulation but also gives the opportunity to study the dynamics of synapse assembly live and in real time over the course of several hours. We will hence investigate by genetic and pharmacological approaches the implications of the cytoskeleton on synaptogenesis.

[1] Fejtova, A., and Gundelfinger, E.D. (2006). Molecular organization and assembly of the presynaptic active zone of neurotransmitter release. *Results Probl Cell Differ* 43, 49-68.

[2] Maeder, C.I., Shen, K., and Hoogenraad, C.C. (2014). Axon and dendritic trafficking. *Curr Opin Neurobiol* 27, 165-170.

[3] Hartman, M.A., and Spudich, J.A. (2012). The myosin superfamily at a glance. *J Cell Sci* 125, 1627-1632.

Development of distinct descending cortical pathways

Philipp Abe^{1,2}, Adrien Lavalley¹, Ilaria Morassut¹, Esther Klingler¹, Antonio Santinha³,
Randall Platt³, Denis Jabaudon¹

¹University of Geneva, Department of Fundamental Neuroscience, Rue Michel-Servet 1, 1211 Geneva, Switzerland

²University of Dresden, Institute of Anatomy, Fiedlerstraße 42, 01307 Dresden, Germany

³Department of Biosystems Science and Engineering, ETH Zurich, Mattenstrasse 26, 4058 Basel, Switzerland.

The cerebral cortex is organized into specialized areas that process different types of information necessary for somatosensory, visual, and motor function. Within these areas, layer 5 extratelencephalic neurons (L5 ET neurons) are a key population of neurons allowing efferent signals to be sent to subcortical targets following intracortical processing. While recent progress has been made in understanding the molecular and projection diversity of L5 ET neurons across cortical regions¹⁻³, how this diversity emerges during development remains unknown. Here, by combining single-cell transcriptomics and connectomics using MAPseq mapping in the mouse, we show that area-specific L5 ET properties emerge from two ground state identities present at birth (proximal- and distal-projecting), onto which area-specific transcriptional programs are superimposed postnatally to allow area-specific connectivities in adults. Hence, the diversity of corticofugal neurons results from a combinatorial process in which a limited number of cell types develop divergent projection patterns through area-specific postnatal transcriptional programs.

1 Economo, M. N. et al. Distinct descending motor cortex pathways and their roles in movement. *Nature* 563, 79-84, doi:10.1038/s41586-018-0642-9 (2018).

2 Muñoz-Castañeda, R. et al. Cellular anatomy of the mouse primary motor cortex. *Nature* 598, 159-166, doi:10.1038/s41586-021-03970-w (2021).

3 Yao, Z. et al. A taxonomy of transcriptomic cell types across the isocortex and hippocampal formation. *Cell* 184, 3222-3241.e3226, doi:10.1016/j.cell.2021.04.021 (2021).

Development of GABAergic synapses in the sensory cortex of early postnatal mice

Ahd Abusaada¹, Prof. Dr. Werner Kilb¹, Prof. Dr. Heiko Luhmann¹

¹Institut für Physiologie in Johannes Gutenberg Universität, Apl.-Prof. Dr. Werner Kilb und Prof. Dr. Heiko Luhmann,
Universitätsmedizin der Johannes Gutenberg-Universität
Institut für Physiologie
Duesbergweg 6
D-55128 Mainz

Development of GABAergic synapses in the sensory cortex of early postnatal mice

Ahd Abusaada, Anne Sinning, Heiko J. Luhmann and Werner Kilb

Institute of Physiology, University Medical Center of the J.-Gutenberg University Mainz, Mainz, Germany

Establishment of GABAergic connectivity is a prerequisite for functional cortical networks. In addition, GABA receptors mediate several developmental processes like migration or synaptogenesis. Therefore, we characterized the developmental trajectory of GABAergic synapse formation in the primary sensory cortex of neonatal mice between postnatal day (P) 0 and P8. GABAergic synapses were identified from confocal images upon immunohistochemical labeling and quantification of profiles (0.25 – 2.42 μm^2) positive for the presynaptic marker vGAT and the postsynaptic marker gephyrin. Gephyrin-positive profiles overlapping or in close proximity ($<0.31 \mu\text{m}$ Euclidean distance) to vGAT positive profiles were considered as synapses. Our results demonstrate a low density of GABAergic synapses ($\leq 32 \text{ mm}^{-2}$) in most layers of the early postnatal brain (P0-2), while a pronounced concentration of synapses ($118 \pm 53.2 \text{ mm}^{-2}$) can be observed in the marginal zone (MZ). In P3-5 animals the density of GABA synapses in the MZ increases, reaching values of $245 \pm 189.1 \text{ mm}^{-2}$. In addition, moderate levels of GABA synapses appeared in layer (Ly) 4 ($64 \pm 9.4 \text{ mm}^{-2}$) and the subplate ($66 \pm 18.4 \text{ mm}^{-2}$). At P5-8 the density of GABAergic synapses amounts to $166 \pm 44.1 \text{ mm}^{-2}$ in the MZ, $171 \pm 7.5 \text{ mm}^{-2}$ in Ly 2/3, $105 \pm 7 \text{ mm}^{-2}$ in Ly 4, and $43 \pm 4.3 \text{ mm}^{-2}$ in Lys 5/6. In summary, our results revealed a structured GABAergic synaptogenesis in the first postnatal week, with initial synaptogenesis in the MZ, followed by the thalamoreceptive layers subplate and Ly 4, while GABAergic synapses in the other layers appear only later.

Developmental competition ensures correct synapse numbers for motor circuit assembly and function

Lion Huthmacher¹, Selina Hilgert¹, Silvan Hürkey¹, Stefanie Ryglewski¹, Carsten Duch¹

¹Johannes Gutenberg-Universität Mainz, Institute of Developmental Biology and Neurobiology, Hanns-Dieter-Hüsch-Weg 15, 55128 Mainz, Germany

This project addresses the developmental mechanism that assigns the correct numbers of synapses to an ensemble of five wing depressor motoneurons in the fruit fly *Drosophila melanogaster*. We have previously characterized the anatomy and the physiology of these motoneurons. In brief, the five motoneurons (MNs) that innervate the dorsal longitudinal flight muscle (DLM) share common excitatory cholinergic synaptic input to their dendrites. Moreover, each MN exhibits similar dendritic length (~6000 μm dendritic length) and branch numbers that intermingle in the same space of the flight motor neuropil. Similarly, all 5 MNs show nearly identical input-output operations with matching I/F curves that exhibit linearity within the working range of firing frequencies relevant for flight behavior. Consequently, all 5 MNs fire at identical frequencies during flight, which is highly relevant for flight power production [for detail see Hürkey et al., BioRxiv, 2022]. However, the mechanisms that ensure an equal proportion of cholinergic synaptic input to all 5 MNs remain unknown. Based on previous findings on synapse distributions to different dendritic domains of one DLM flight MN [Ryglewski et al., Neuron, 2017], we hypothesize that competition between presynaptic partners for the collective dendritic material of all 5 MNs during synaptotropic growth allocates equal amounts of excitatory input to all 5 MNs.

To test this, we selectively decrease dendrite size in subsets of the 5 DLM MNs during circuit development and test the resulting consequences on dendrite size and input synapse numbers of all 5 MNs, as well as on their firing frequencies during flight and flight behavioral performance. To reduce dendrite size in subsets of MNs we target *Dscam1* RNAi randomly to few MNs by employing a Flippase strategy. *Dscam1*-knockdown reduces dendrite size of the targeted MNs by up to 90% without changing their membrane properties [Ryglewski et al., PNAS, 2014]. We then test dendrite size in the other DLM MNs by intracellular dye fills followed by quantitative dendritic architecture analysis. To determine the partitioning of cholinergic synapse numbers between MNs upon the reduction in dendrite site in subsets of MNs, we employ activity dependent GRASP combined with intracellular dye fills, confocal imaging, and quantitative input synapse number estimates. Lastly, electromyographic recordings during tethered flight reveal consequences of the altered cholinergic partitioning for motor output and behavior. First preliminary data indicate that competition between sibling neurons may indeed provide mechanism to allocate equal proportions of input synapses to an ensemble of neurons without the need to genetically encode input synapse numbers for each neuron.

Emergence of cortex-wide calcium dynamics during postnatal mouse development

Davide Warm¹

¹University Medical Center of the Johannes-Gutenberg University, Institute of Physiology, Duesbergweg 6, 55128 Mainz, Germany

The mammalian cerebral cortex presents a modular organization, which enables the segregated processing of specialized functions and, through their integration, the generation of complex cognitive states. In the mouse brain, the underlying anatomical and functional correlates of this network topology start to form during the perinatal period. In postnatal development, on-going cortical activity is fundamental in shaping cortical areas and their functions. Spontaneous activity generated in the central nervous system and incoming sensory inputs from the periphery trigger different spatio-temporal patterns of neuronal activation, which impinge on the cytoarchitecture and connectivity of cortical regions. Thus, understanding how local activity patterns emerge and contribute to cortex-wide dynamics is essential to elucidate the proper development of the cortex.

Here, we perform pan-hemispheric wide-field calcium imaging in Snap25-2A-GCaMP6s-D mice during the first two postnatal weeks. Recording spontaneous and sensory evoked activity, we monitor the emergence and distribution of population calcium dynamics across the cortex. Overall, activity rates increase over the experimental time window, whereas the amplitude of calcium signals progressively decreases after peaking at the end of the first postnatal week. In line with a decrease in correlation, the latter is indicative of the sparsification of cortical activity that is usually observed in this period. Through anatomical and functional segmentation, we quantify and compare the level and complexity of activity within different spatial domains during early development and relate them to the canonical arealization of the mature mouse cortex. The results highlight the appearance of functionally-segmented regional clusters during the first postnatal week, reaching a maximum number around postnatal day (P) 10. Although these clusters present a relatively stable spatial arrangement in the frontal and caudal areas of the cortex, parcellation within the parietal cortex appears highly dynamic and only partially overlaps with classical atlas-based areas. Furthermore, using information theoretic approaches, we investigate how correlated activity evolves during development and infer emerging functional connections across cortical regions. In conclusion, our analysis highlights the presence of a drastic change in the dynamics of pan-cortical cortical activity at the end of the first postnatal week when critical steps in cellular maturation and circuit connectivity take place.

Flies in a centrifuge: Rewiring the brain with hyper-gravity

Felix Graf¹, P. Robin Hiesinger¹

¹Division of Neurobiology, Institute for Biology, Free University Berlin, 14195 Berlin, Germany

The evolution and development of all organisms on earth relies on near-constant gravity. Experimental manipulations can create developmental conditions that have never been encountered during evolution, yet reveal developmental mechanisms based on informative phenotypic outcomes; classically, such experiments include grafting and transplantation of developing organs as well as pushing boundaries of environmental conditions. Here, we explore the outcome of *Drosophila* brain development at 10^2 to 10^3 earth gravity.

Remarkably, *Drosophila* pupae fully develop without developmental delay when exposed to 300g throughout the period of brain wiring (P50-100). The adult brains of such flies exhibit an asymmetry: synaptic neuropils exhibit a reduction in volume only on the side pointed to by the gravity vector, while the other side appear morphologically normal. Single cell morphological analyses, reveal largely unaltered neuronal branching patterns, except for a mild compression of layers of the optic lobe medulla neuropil on the gravity-affected side. However, analysis of synaptic connectivity with the trans-synaptic tracer trans-tango, revealed a surprisingly dramatic change of synaptic partners to R7 photoreceptor neurons; these changes include a substantial loss of synapses with the main postsynaptic partner Dm8, despite largely unaltered neuronal morphologies. Since the control side of the brain had experienced the same hyper-gravity, yet exhibited normal connectivity, we conclude that hyper-gravity does not directly affect molecular or subcellular processes, but caused these effects by a redistribution of resources in the fly pupa. The extend and nature of these synaptic changes reveal the plasticity and principles of how the genetically encoded developmental program leads to specific connectivity during brain wiring.

Influence of developmental temperature on the wiring and variability of the *Drosophila* olfactory pathway

Pascal Züfle¹, Leticia Batista¹, Carlotta Martelli¹

¹Johannes Gutenberg-Universität Mainz, Institute of Developmental Biology and Neurobiology (iDN) - Martelli Lab, Hanns-Dieter-Hüsich-Weg 15, 55128 Mainz, Germany

The neural architecture of the *Drosophila* olfactory pathway is determined by a detailed genetically controlled developmental program, that leads to the genesis of all cellular types and their synaptic connectivity. However, this process is not completely deterministic and some of the underlying processes are inherently stochastic. Whether this leads to a variable circuit architecture and whether such variability has any biological function remains unclear.

Here we investigate variability in the connectivity of specific Olfactory Receptor Neurons (ORNs) and their postsynaptic partners in the Antennal Lobe (AL), one of the most stereotypic neural maps in the fly brain.

We show that developmental temperature strongly affects olfactory pathway connectivity. Using the trans-synaptic labeling method trans-Tango, we show that the number of postsynaptic partners of ORNs expressing the odorant receptor OR42b, that innervate the glomerulus DM1, decreases by a factor of three in flies developed at 25°C compared to 18°C across different ages (5-, 10-, and 15-days). The number of postsynaptic partners of DM1 in flies developed at 25°C match the number of the corresponding neurons in the hemibrain connectome, while the number of neurons in flies developed at 18°C show significant differences to the connectome. The cell bodies (CBs) of these second order neurons are located around the AL in the dorsal, lateral, and ventral clusters. We found that the decrease in postsynaptic DM1 partners at higher developmental temperatures is not the same for all CB clusters. While the number of neurons presenting their CBs in the ventral and lateral cell cluster decrease, the number of neurons with CBs in the dorsal cluster increase, indicating a shift in connections. These data are consistent with a lower number of synapses in DM1 decrease in flies developing at 25°C compared to 18°C.

We further quantify variation in the number of neurons postsynaptic to different ORNs (OR7a, OR42b and OR67d) comparing individuals and hemispheres of the same brain, showing that inter-individual variability of the postsynaptic neurons is dependent on their CB position. Finally, we investigate the functional consequences of the non-canonical postsynaptic partners of DM1 using in vivo calcium imaging.

Temperature dependent wiring has been previously observed in the visual system between R7 photoreceptors and their postsynaptic partners (Kiral et. al. 2021). Our results suggest the existence of common principle for the development of sensory maps in the brain and open the question of what the functional consequence are for odor processing.

Pharmacological modulation of the GluN2C/2D NMDA receptor subunit does not influence interneuron and pyramidal cell maturation in visual cortex OTC's

Lisa Marie Rennau¹, Leon Hoffmann¹, Ina Köhler¹, Petra Wahle¹

¹Ruhr Universität Bochum, AG Entwicklungsneurobiologie, Universitätsstraße 150 , 44801 Bochum, Germany

Neuronal activity is one of the driving forces in the developing nervous system. Especially, the cortex requires glutamatergic transmission for structural and functional maturation of pyramidal cells and interneurons. The pharmacological inhibition of the GluN2B receptor subunit leads to increased basal dendrite growth in pyramidal neurons (Gonda et al., 2020). In contrast, the GluN2C/2D receptor subunits are almost exclusively expressed on parvalbuminergic, fast spiking interneurons with little to no expression on pyramidal cells (Garst-Orozco et al., 2020; Hanson et al., 2019). The GluN2C/2D receptor subunit containing interneurons are integrated into the neuronal network and influence the activity pattern needed for morphological maturation. Recently it has been reported that pharmacological inhibition of the GluN2C/D receptor subunit with the antagonist DQP-1105 at P7-9 leads to reduced morphological interneuron complexity in parvalbumin positive interneurons at P20-21 in somatosensory cortex in vivo (Hanson et al., 2019).

Pharmacological activation and inhibition of the GluN2C/2D receptor subunits was performed with the agonist CIQ (15 μ M), the antagonist DQP-1105 (15 μ M) and the negative allosteric modulator NAB-14 (10 μ M) from DIV 5-10, daily, followed by morphological assessment at DIV 11. Immunohistochemical staining against GluN2D reveals an interneuron-specific localization in the dendrite, soma and especially in the axon of the cell, in a subset of interneurons. However, the activation with CIQ does not result in changes in dendrite length or branching in interneurons. Also, the basal or apical length of pyramidal neurons remains unchanged with CIQ stimulation. The inhibition with DQP-1105 does not lead to changes in the length or branching of interneurons dendrites, also the length and branching of basal and apical dendrites is not changed. Reducing the activity of the GluN2C/2D subunits with NAB-14 also does not show changes in length and branching of interneuron dendrites and the length and branching of basal and apical dendrites remains unchanged. Up to this point we can not confirm that the activity of the GluN2C/2D receptor subunit influences the morphological maturation of interneurons or the maturation of pyramidal neurons.

Robustness of Early Pattern Formation in the *Drosophila* Visual Map

Berna Melinda Nabavi¹, Charlotte B. Wit¹, Egemen Agi¹, P. Robin Hiesinger¹

¹Freie Universität Berlin, Neurobiology

The *Drosophila* visual map is a highly patterned synaptic brain region formed by photoreceptor axon terminals in the lamina. We investigated the spatiotemporal organization and the underlying molecular mechanisms that ensure early pattern formation of this visual map. Unit eyes (ommatidia) and photoreceptor neurons (R1-R6) differentiate in a temporal wave in the developing eye disc; axon outgrowth follows the same wave pattern through the optic stalk that connects the eye disc and the lamina. Here, we show that photoreceptor bundles are organized in two interdependent ways: first, each ommatidium preserves the rotational organization of R1-2-3-4-5-6 (intra-bundle organization); second, R1-R6 bundles preserve their relative positions to each other through the optic stalk and into the lamina (inter-bundle organization). Both types of bundle organization require the cell adhesion molecule Sidekick to preserve the pattern originating in the eye disc. In *sdk*-mutant clones, single photoreceptor axons detach from their original bundle and either re-attach to the same or another bundle. In the lamina, the axon terminals show rotation defects. Following the well-characterized differentiation order in the eye disc (R2/5, followed by R3/4, followed by R1/6), the R2 and R5 axons arrive first in the lamina, where they form an 'equator-blind' pattern, i.e. R2 and R5 projections are identical on both sides of the mirror-symmetric axis that divides the dorsal and ventral halves of the eye. The adhesion G-protein coupled receptor Flamingo/Starry Night (Fmi) is strongly expressed in the newly arriving photoreceptors and its protein localization marks the equator-blind scaffold in a remarkably orthogonal (as opposed to hexagonal) pattern throughout visual map formation. In parallel work, we have shown that R1-6 axon terminals form a largely 2-dimensional sheet of ~5000 growth cones that requires adhesive interactions amongst R1-6 growth cones (see abstract by Agi et al.). Loss of *fmi* in R2 and R5, but not in R3,4,1, or 6, leads to a disruption of this growth cone sheet during early patterning. Loss of *fmi* in a cluster of adjacent photoreceptor axon terminals leads to breaks in the growth cone sheet where whole bundles detach and mislocalize to nearby brain regions. Knockdown of Fmi in all photoreceptors leads to wiring defects in the final pattern, whereas early patterning seems to be mostly intact. Hence, Fmi maintains an adhesive scaffold throughout visual map formation, but this function does not utilize canonical, frizzled-dependent planar cell polarity signaling. In contrast to larger clones, loss of the bundle-organizing Sidekick or the growth cone sheet-adhesive Fmi in individual axon terminals leaves the overall patterning intact. We conclude that early visual map patterning is based on selective adhesive interactions that robustly ensure the correct pattern even if single cells are defective.

Systematic functional analysis of Rab GTPases in neuronal development and maintenance

Ilsa-Maria Daumann¹, Friederike E. Kohrs¹, Hanna Stiedenroth¹, P. Robin Hiesinger¹

¹Freie Universität Berlin, BCP, Königen-Luise-Straße 1-3, 14195 Berlin, Germany

Neurons are morphologically elaborate and long-living cells. Both features put special demands on membrane trafficking. Rab GTPases are regulators of membrane trafficking and the *Drosophila* genome encodes 26 *rab* genes. All *rabs* are expressed in the nervous system and 13 of the 26 *rabs* exhibit nervous system-enriched expression patterns. To facilitate systematic functional analyses of neuron-specific membrane trafficking, we have generated a complete *rab* null mutant collection. Remarkably, the complete loss of any of the 13 nervous system-enriched Rabs did not cause obvious defects concerning fly survival, fertility, or morphology under laboratory conditions. However, under challenging conditions including continuous neuronal stimulation or temperature variation all *rab* mutants revealed specific sensitivities affecting development, function, or maintenance of the nervous system. Our observations suggest that the majority of Rabs serve modulatory functions that ensure robustness of development or function to challenging environmental conditions.

We followed up on our initial systematic characterization with a more detailed analysis of four neuronal or neuron-enriched *rabs*: *rab26*, *rab19*, *rabX1* and *rabX4*. Rab26 has previously been proposed to link synaptic vesicle recycling and autophagy. However, our characterization of the *rab26* mutant revealed no autophagosomal or synaptic vesicle defects in flies. Instead, we found an activity-dependent role of Rab26 in receptor trafficking at cholinergic synapses. Our analyses of *rab26*, *rab19*, *rabX1* and *rabX4* revealed synthetic lethality for double mutants of *rabX1* with each of the other three, but no other double mutant combination. We will present an update on our characterization of the functional contributions of each of these *rabs*.

The cell surface protein Roughtest mediates neurite branch competition during brain wiring

Abhishek Jayant Kulkarni¹, Thanh Thanh Tu Tran¹

¹Freie Universität Berlin, AG Prof. Hiesinger, Königin Luise Str. 1-3, 14195 Berlin, Germany

The Roughtest protein is a cell adhesion molecule that is dynamically localized on axons and subsequently restricted to synaptic regions. Loss of roughtest (rst) is suggested to cause axon pathfinding and synaptic specificity defects in the visual system. Here, we recreated a clean null mutant and a classical C-terminal truncation variant in the endogenous locus using CRISPR and show that neither mutant exhibits the previously reported phenotypes. While both mutants yield viable adults with normal eye morphology and no obvious axon pathfinding defects, complete loss-of-function adults exhibit defects in visually guided behavior, shortened lifespan and are sensitive environmental challenges.

While loss of rst in all photoreceptor neurons causes no obvious developmental defects, rstCRISPR null mutant clones are eliminated from the eye epithelium. This suggests a role in cell competition that only leads to defects when neighboring cells exhibit different Rst levels. We analyzed a series of optic lobe neurons with down- or upregulated Rst levels to test for axonal competition. Amongst these, L4 interneurons exhibited the strongest competition phenotypes with reduced Rst leading to branch retractions and increased Rst levels causing branch extensions. Remarkably, changing Rst levels in all L4 neurons caused no deviations from the wild type morphology. Furthermore, dorsal cluster neurons (DCNs) exhibited rst levels-dependent axonal innervation defects. Changes in DCN branching asymmetry are sufficient to cause defects in the visual attention using the Buridan assay, that are similar to the behavioral defects we observed in rst mutants.

We further generated wild type and C-terminally truncated Rst endogenously tagged with the acidification sensing dual fluorophore combination pHluorin-mCherry. C-terminally truncated Rst exhibits degradation defects that lead to longer persistence of Rst. Together, these findings suggest that Rst is neuron-specifically employed as a competition receptor during neurite branch extension, thereby contributing to the appropriate development of connectivity and visual behavior.

The development of MC3R neurons, AgRP and POMC neuronal projections and the maintenance of intra-hypothalamic neuronal circuits.

Selma Yagoub¹

¹German Institute of Human Nutrition (DIfE), Neurocircuit development and function (NDF), Arthur-Scheunert-Allee 114-116, 14558 Potsdam, Germany

The melanocortin system has been extensively studied for its role in regulating feeding behavior and the metabolism. However, the role of this system in early development and the establishment of these neuronal circuits are less well known. We sought to study the establishment of key connections from the arcuate nucleus of the hypothalamus (ARC) neurons, namely agouti-related peptide (AgRP) and Pro-opiomelanocortin (POMC), in early development and their persistence into adulthood. In addition to this, we analyzed how the loss of the melanocortin 3 receptor (MC3R), expressed by AgRP neurons, affect these AgRP and POMC neuronal projections specifically within the hypothalamus. qPCR data collected throughout the development suggests a dynamic regulation for the MC3R expression in the hypothalamus. Therefore, using the MC3R-GFP mouse model, we were able to assess the dynamic development of MC3R neurons in the hypothalamus. These results suggest that MC3R is absolutely critical for the development of POMC and AgRP neuronal connections within the hypothalamus. Elaborating on previous literature assessing the structural development of ARC neuronal projections, we identified, throughout development, the positive labeling of the individual of AgRP and POMC neuropeptides themselves to intra but also interesting extra-hypothalamic structures. The dynamic regulation of MC3R expression and establishment of neuronal connectivity in early development underscores the probable role of the melanocortin system not only in adult feeding behavior, but also in early formation of AgRP and POMC neurocircuits.

The role of MAST2 in neurodevelopment and disease

Alexandra Catalina Vilceanu¹, Maria Sergaki², Fernanda Martinez-Reza², Florian Walter¹,
David Keays^{1,2,3}

¹Department of Neurobiology, Ludwig-Maximilians-Universität, München, Germany

²Institute of Molecular Pathology, Vienna Biocenter, Vienna, Austria

³Department of Physiology, Development and Neuroscience, Cambridge University, UK

Constructing a human brain, from progenitor cells to transhemispherically connected mature neurons, relies on a myriad of molecular and cellular events. Genetic mutations that perturb the birth, migration or differentiation of neurons can cause severe neurodevelopmental disorders. Recent studies have implicated the microtubule-associated kinases MAST1-4 in neurological conditions such as the mega-corpora-callosum syndrome or developmental and epileptic encephalopathy; however, the underlying molecular mechanisms remain unknown.

In this study, we define the clinical profile associated with variants in **MAST2** and investigate how mutations in this gene cause disease. Drawing on a network of clinical collaborators, we have established a cohort of patients with MAST2 mutations. These patients exhibit classical symptoms of altered neurodevelopment including *early-onset epilepsy*, *autism spectrum disorder* and *intellectual disability*.

To further study the pathogenesis of MAST2 mutations, we have set up **two mouse models**: a MAST2 knock-out, as well as a mouseline recapitulating a patient mutation. Current work focuses on characterizing the behavioural, anatomical, and molecular phenotype of MAST2 mutant mice. By comparing the phenotypes of these mouse lines, we aim to gain insight into the effects of a MAST2 deficit on brain development, as well as whether the patient-derived mutation acts by a gain or loss of function mechanism. Lastly, we aim to consolidate our understanding of the disease state using **patient-derived cellular models**. To this end, we are currently reprogramming patient-derived fibroblasts into induced pluripotent stem cells. Taken together, this study will aid the molecular diagnosis of neurodevelopmental disorders, shed light on pathophysiological mechanisms associated with MAST2 mutations, and provide insight into the genetic architecture required to build a human brain.

| Cohort of patients with MAST2 mutations and neurodevelopmental phenotypes | | | | | | | |
|---|----|----|----|--|----|----|----|
| | P1 | P2 | P3 | P4 | P5 | P6 | P7 |
| MRI modif. | | ✓ | | (In utero) Brainstem malformations | ✓ | | ✓ |
| Seizures | ✓ | | ✓ | | | ✓ | ✓ |
| ASD, ID | ✓ | ✓ | ✓ | | ✓ | ✓ | ✓ |

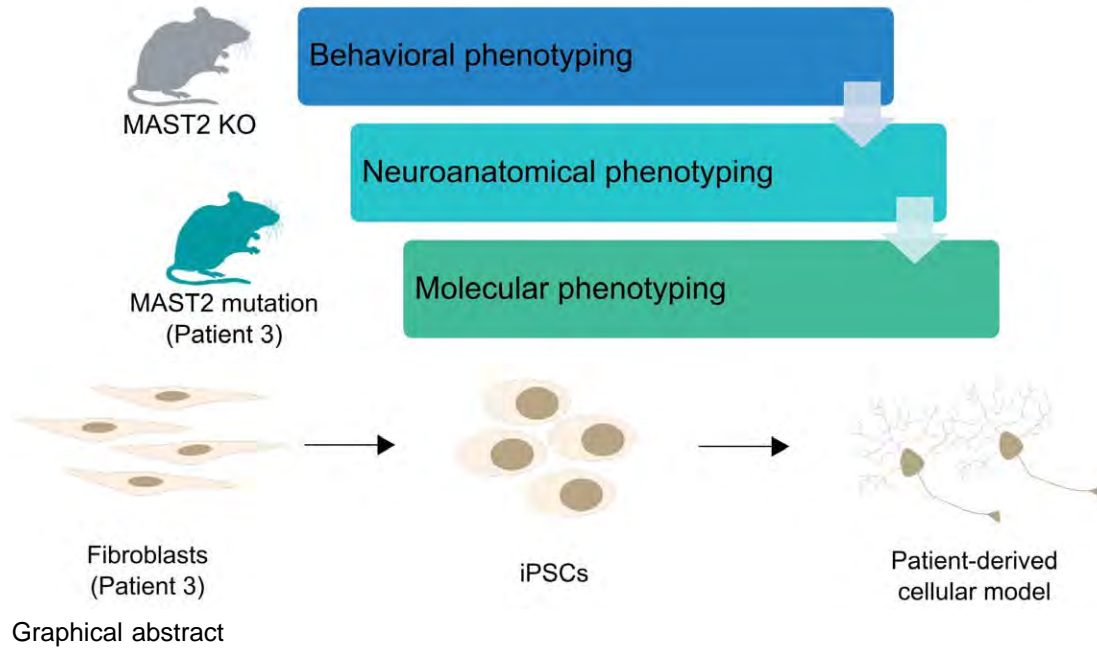

Graphical abstract

Visual map formation without target-dependent guidance in *Drosophila*

Egemen Agi¹, Eric Reifenstein^{2,3}, Charlotte Wit¹, Monika Kauer¹, Teresa Schneider¹, Max von Kleist^{2,3}, Peter Robin Hiesinger¹

¹Division of Neurobiology, Institute for Biology, Freie Universität Berlin, Germany

²Systems Medicine of Infectious Disease (P5), Robert Koch Institute, Berlin, Germany

³Bioinformatics (MF1), Robert Koch Institute, Berlin, Germany

Precise brain wiring relies on specific connections between pre- and postsynaptic partners, but when and how partner interactions are required to develop functional connectivity may depend on circuit topology. Here we show how *Drosophila* photoreceptor neurons initially establish the intricate wiring pattern of neural superposition independent of their future main postsynaptic partners, the lamina neurons. The correct neural superposition pattern develops, but fails to stabilize, when all lamina neurons are ablated. The ~4800 photoreceptor axon terminals form an epithelium-like growth cone sheet, the lamina plexus, where each growth cone extends to one of ~800 specific target regions that form through morphogenesis of the growth cones themselves, even in an ectopic brain region. Non-invasive intravital live imaging and computational modeling reveal that growth cone filopodia both generate and sense a dynamic density landscape that robustly guides growth cone extension, followed by pattern stabilization through the future postsynaptic partners. Hence, the fly visual map is a model for how pre- and postsynaptic neuronal processes can form independent patterns to ensure correct partners are available for subsequent synapse formation.

E.A & E.R. equal contribution P.R.H. & M.V.K. co-corresponding

Chrono-Anatomical Description of Dopaminergic Neurons during Metamorphosis in *Drosophila melanogaster*

Anne Sophie Oepen¹, Jiajun Zhang¹, Oren Schuldiner², Kei Ito¹, Thomas Riemensperger¹

¹Experimental Morphology / Neuroanatomy, Institute of Zoology, University Cologne, Cologne, Germany

²Dept of Molecular Neuroscience, and Dept of Molecular Cell Biology, Weizmann Institute of Science, Rehovot, Israel

Modulatory neurons such as dopaminergic neurons (DANs) play decisive roles in the behavior control of larvae and adult *Drosophila*. Each DAN contributes to distinct parts of the brain compartments. Animals at these two developmental stages occupy largely different ecological niches, for which different ways of adaptation of the behavior controlling neuronal networks should be required. Whereas the anatomy of modulatory networks is well described in larval and adult *Drosophila*, our knowledge is scarce about the transition between the two stages. Here, we present a precise chrono-anatomical analysis of DAN circuits and their target brain compartments by performing immunohistochemical labelling against tyrosine hydroxylase (TH) and nCadherin (CadN) respectively, throughout the pupal development. During metamorphosis the axon branches of the larval mushroom body (MB) lobes prune back to the lateralmost part (18h APF) that will become the γ 1 compartment in the adult, and regrow (24hAPF) to form the adult γ -lobe. On the contrary, the central complex (CX) is only rudimentarily present in larvae and develops extensively during metamorphosis. Despite the different developmental strategies of the MB and CX we monitored a chronologically concerted innervation of these neuronal compartments by TH-immunoreactive neurons. The PAM cluster shows no TH immunoreaction during MB remodelling (18h APF to 24h APF) but with a temporal delay after 48h APF. The PPM3 cluster, which only appears TH immunoreactive at 18h APF shows a chronologically synchronized innervation to the PAM cluster after 48h, eventhough the CX is already present before and does not undergo remodelling comparable to the MB. In contrast to the brain regions that undergo sever alterations, the overall structure of gnathal ganglion appears very stable during metamorphosis and only displays shallow alterations in the large-scale DAN innervation patterns. Our study thus revealed striking differences in DAN circuit reorganization depending on the positions in the brain.

Cyclase-associated protein 1 (CAP1) inhibits MRTF-SRF-dependent gene expression in the mouse brain

Sharof Khudayberdiev¹, Anika Heinze¹, Uwe Linne², Marco B Rust¹

¹Philipps-University of Marburg, Molecular Neurobiology Group, Institute of Physiological Chemistry, Karl-von-Frisch-Str. 2, 35032 Marburg, Germany

²Philipps-University of Marburg, Department of Chemistry, Hans-Meerwein-Straße 4, 35032 Marburg, Germany

Serum response factor (SRF) is ubiquitously expressed transcription factor essential for brain development and function. One of the coactivators that regulate transcriptional activity of SRF in the nucleus is myocardin-related transcription factors (MRTF). Subcellular localization of MRTF is tightly controlled by binding of monomeric actin (G-actin), which keeps the former in the cytoplasm. G-actin-free MRTF can translocate into the nucleus and activate SRF-dependent gene expression. Since actin binding proteins, such as cofilin, actin depolymerizing factor (ADF), profilin and cyclase-associated protein (CAP), are involved in actin (de)polymerization and thereby influence the concentration of G-actin in the cell, we hypothesized the role of those proteins in MRTF-SRF-dependent gene expression in neurons. Surprisingly, the key actin-depolymerizing proteins – cofilin and ADF were largely dispensable for neuronal MRTF-SRF activity. Instead, reporter assays combined with pharmacological and genetic approaches in isolated neurons from mutant mice identified cyclase-associated protein 1 (CAP1) as an important regulator of the MRTF-SRF pathway. Mechanistically, CAP1 promotes cytosolic MRTF retention and represses neuronal SRF activity by regulating cellular G-actin levels. RNAseq and mass spectrometry analysis of mice brain cortices deficient in CAP1 showed dysregulation of MRTF/SRF-dependent gene regulation, thus implying *in vivo* relevance of CAP1 in this process. Together, we identified CAP1 as a crucial repressor of the MRTF-SRF pathway in the brain.

Poster Topic

T3: Developmental Cell Death, Regeneration and Transplantation

- [T3-1A](#) Activity-dependent regulation of the BAX/BCL-2 pathway protects cortical neurons from apoptotic death during early development
Jonas Schroer, Davide Warm, Heiko J Luhmann, Anne Sinning
- [T3-2A](#) An analysis of temperature dependence discloses two distinct processes in axon regeneration
Céline Rehrl, Alexander Hecker, Stefan Schuster
- [T3-1B](#) Chromatin compaction precedes apoptosis in developing neurons
Elena Nigi, Renata Rose, Nicolas Peschke, Márton Gelléri, Sandra Ritz, Christoph Cremer, Heiko J. Luhmann, Anne Sinning
- [T3-2B](#) Patterned electrical activity regulates neuronal apoptosis in immature cortical neurons and networks
Anne Sinning, Davide Warm, I. Emeline Wong Fong Sang, Jonas Schoer, Werner Kilb, Heiko J. Luhmann
- [T3-1C](#) Restoration of motor function through intraspinal delivery of human IL-10-encoding nucleoside-modified mRNA after spinal cord injury
Antal Nógrádi, László Gál, Annamária Marton, Zoltán Fekécs, Drew Weissmann, Dénes Török, Rachana Biju, Csaba Vizler, Paolo Lin, Ying Tam, Norbert Pardi, Krisztián Pajer

Activity-dependent regulation of the BAX/BCL-2 pathway protects cortical neurons from apoptotic death during early development

Jonas Schroer¹, Davide Warm¹, Heiko J Luhmann¹, Anne Sinning¹

¹Institut für Physiologie, Unimedizin Mainz, AG Luhmann, Duesbergweg 6, 55128 Mainz, Germany

A significant proportion of cortical neurons undergo apoptosis during early brain development. This process of programmed cell death, which critically determines the final anatomical and functional formation of the brain, is area-specific and time-dependent. Moreover, simultaneously with the apoptosis wave, highly synchronous cortical activity patterns appear. Electrical activity is known to be beneficial for neuron survival, and its blockade leads to a significant increase in caspase 3 activation and subsequently to an increase in apoptosis. However, how the beneficial effect of electrical activity is translated into better survival chances of neurons on a cellular level is not fully understood. In this study, we show that during the first two postnatal weeks, two major players in the intrinsic apoptosis pathway, BAX as a pro-apoptotic factor and BCL-2 as an anti-apoptotic factor, are developmentally regulated such that the BAX/BCL-2 ratio in the cortex peaks at a time of high apoptosis *in vivo*. Interestingly, the overall caspase activity gradually decreases over the same time course. On the cellular level, Bax vs. Bcl-2 expression is lower in active (Arc-positive) compared to inactive (Arc-negative) neurons. Accordingly, early active neurons with a low Bax expression are less likely to die in developing networks *in vitro*. Confirming the activity dependent regulation of this pathway, short term pharmacological blockade of activity increases Bax expression and cell death rates. Furthermore, through the overexpression of aCasp3 via a double AAV approach, we investigate the neuroprotective effect of electrical activity in neurons prone to die via apoptosis. Pharmacological disinhibition of the network prevents the aCasp3 dependent cell death despite high caspase 3 activity. Underlying the neuroprotective effect, we observe a significant upregulation of Bcl-2 expression, resulting in a shift of the Bax/Bcl-2 ratio towards survival. Taken together, we show that electrical activity promotes survival of developing neurons through regulation of the Bax/Bcl-2 pathway. Notably, high electrical activity leads to higher tolerance for caspase 3 activity and thus, not only increasing survival chances of neurons, but also promoting non-apoptotic caspase 3 functions during early cortical development.

An analysis of temperature dependence discloses two distinct processes in axon regeneration

Céline Rehr¹, Alexander Hecker¹, Stefan Schuster¹

¹University of Bayreuth, Department of Animal Physiology, Universitätsstraße 30, 95440 Bayreuth, Germany

Fish and amphibia are established models for studying axonal regeneration in the spinal cord. One potential advantage of these models has not previously been used: because they are poikilothermic, it should be possible to differentiate distinct processes exploiting their different temperature dependency. Here we study regeneration in individual Mauthner axons in larval zebrafish. We have recently shown that these axons not only regenerate rapidly but also allow the study of functional regeneration. Using a two-photon laser we were able to lesion both Mauthner axons at precisely set distances from the soma. This leads to robust regeneration processes with remarkably little variation across individuals at each given temperature. We find that processes during the first phase of axon regeneration ($Q_{10} = 5.0$) and the subsequent regrowth phase ($Q_{10} = 6.1$) are indeed differently influenced by temperature. This opens up interesting new avenues into the nature of the underlying processes.

Chromatin compaction precedes apoptosis in developing neurons

Elena Nigi¹, Renata Rose¹, Nicolas Peschke¹, Márton Gelléri², Sandra Ritz², Christoph Cremer^{2,3,4}, Heiko J. Luhmann¹, Anne Sinning¹

¹University Medical Center of the Johannes Gutenberg University, Institute of Physiology, Mainz, Germany

²Institute of Molecular Biology gGmbH (IMB), Mainz, Germany

³Kirchhoff Institute for Physics (KIP), University of Heidelberg, Heidelberg, Germany

⁴Interdisciplinary Center for Scientific Computing (IWR), University of Heidelberg, Heidelberg, Germany

Apoptosis is a physiological cell death process that in the nervous system allows well-controlled removal of superfluous or malfunctioning neurons. It is induced by the activation of specific signalling pathways and it is characterized by well-known hallmarks such as chromatin condensation, cytoplasmic shrinkage and membrane blebbing. However, a detailed characterization of apoptotic chromatin reorganization dynamics has never been performed before. In this study, super-resolution microscopy (SRM), time-lapse confocal imaging and pharmacological treatments were combined to elucidate subcellular changes at the nuclear level of developing cortical neurons before and during the execution of neuronal apoptosis.

Confocal imaging of nucleosomes in living neurons and subsequent SRM revealed that chromatin compaction advances together with the progression of neuronal apoptosis (both induced and spontaneous), and goes through five different stages. Notably, early compaction preceded cell death and anticipated the major changes in nuclear size and morphology typically known for programmed cell death (i.e. nuclear shrinkage). This reorganization was not affected by pharmacological blockade of the apoptosis executioner Caspase3, suggesting that the early chromatin rearrangement is not part of the execution of the apoptotic process per se and thus functionally distinct from latter compaction stages. Nonetheless, pharmacological interference with actomyosin activity, necessary for early chromatin compaction, during staurosporine-induced apoptosis reduced cell death-related changes in nuclear expression of the motor protein myosin IC, attenuated activation of caspase, and resulted in less apoptotic and more necrotic-like cell death instead. Therefore, early dynamics proved to be relevant for the execution of apoptotic cell death.

In conclusion, we show that compaction of chromatin in the neuronal nucleus precedes apoptosis execution. These early changes in chromatin structure critically affect cell death and are not part of the final execution of the apoptotic process in developing cortical neurons.

Patterned electrical activity regulates neuronal apoptosis in immature cortical neurons and networks

Anne Sinning¹, Davide Warm¹, I. Emeline Wong Fong Sang¹, Jonas Schoer¹, Werner Kilb¹, Heiko J. Luhmann¹

¹University Medical Center Mainz, Physiology, Duesbergweg, 55128 Mainz, Germany

During early brain development a substantial proportion of neurons is eliminated through programmed cell death. This process is attenuated by increased levels of neuronal activity and enhanced by suppression of activity. Yet, it remains unclear how single neurons within developing networks are selected for cell death or survival and if distinct activity patterns directly encode for survival of individual neurons.

With longitudinal imaging and electrophysiological approaches, we correlate activity and apoptosis on single neuron and network scale in primary cortical cultures. We further apply optogenetic as well as pharmacological approaches to modulate activity in order to test causality of relationships between neuronal activity patterns and cell fate in developing cortical networks. Chronic optogenetic stimulation allowed us to effectively modulate the firing pattern of single neurons in the absence of synaptic inputs while maintaining stable overall activity levels. The results show, that replacing the physiological burst firing pattern with a non-physiological, single pulse pattern significantly increased cell death rates and thus confirmed that patterned action potential firing promotes neuronal survival on the level of single neurons. Mechanistically, burst stimulation led to elevated peaks in intracellular calcium and increased expression level of classical activity-dependent targets but also reduced caspase activity. In further experiments we confirmed that during physiological development spontaneous high frequency spiking activity constrains apoptosis in single neurons in a way that cell fate of individual neurons in developing networks is even predictable based on its immature activity patterns.

In conclusion, high frequency action potential firing is critical for survival of single neurons during cortical network development. The results thus support, on the one hand the essential role of high frequency spiking for cortical neurons but also provide a new mechanism which consolidates cortical network composition when a high modular topology is reached during early development.

Restoration of motor function through intraspinal delivery of human IL-10-encoding nucleoside-modified mRNA after spinal cord injury

Antal Nógrádi¹, László Gál¹, Annamária Marton², Zoltán Fekécs¹, Drew Weissmann³, Dénes Török¹, Rachana Biju¹, Csaba Vizler², Paolo Lin⁴, Ying Tam⁴, Norbert Pardi³, Krisztián Pajer¹

¹University of Szeged, Department of Anatomy, Histology and Embryology, Szeged, Hungary

²Department of Biochemistry, Biological Research Center, Hungarian Academy of Sciences, Szeged, Hungary

³Department of Medicine, University of Pennsylvania, Philadelphia, 19104, Pennsylvania, USA

⁴Acuitas Therapeutics, Vancouver, BC, V6T 1Z3, Canada

Spinal cord injury results in irreversible tissue damage followed by limited recovery of function. Interleukin-10 (IL-10) attenuates the effects of pro-inflammatory cytokines and reduces apoptosis. In this study lipid nanoparticle (LNP)-encapsulated human IL-10-encoding nucleoside-modified mRNA (hIL-10 mRNA-LNP) and recombinant hIL-10 loaded via osmotic pump were used to induce neuroprotection and functional recovery following spinal cord contusion injury in a rat model.

A contusion injury was performed at the level of thoracic 10 (Th10) vertebra. The hIL-10 mRNA LNP or recombinant hIL-10 were administrated 7 days after injury directly into the lesion cavity. Animals in the control groups underwent the same surgical procedure and received either no treatment or lipid nanoparticle (LNP)-encapsulated green fluorescent protein (GFP)-encoding nucleoside-modified mRNA. Locomotor analysis of the animals was carried out through the use of the BBB-test and a video-based locomotor analysis system. The extent of supra- and propriospinal axonal sparing/regeneration was determined by retrograde tracing 9 weeks after the injury. After mRNA injection the level of produced hIL-10 was followed by hIL-10 enzyme-linked immunosorbent assay (ELISA) and Proteome Profiler was used to evaluate the changes of cytokine expression.

The functional analysis showed that hIL-10 in both treatment groups enhanced the coordinated movement relative to controls. Similarly, administration of hIL-10 in both treatment strategies resulted in significantly smaller lesion area at the epicentre of the injury and rescued significantly greater amount of tissue. Analysis of supra and propriospinal connections with the retrograde tracer Fast Blue indicated that hIL-10 treatment enhanced the number of connections between the segments caudal to the lesion and various cranial parts of the CNS. Astrocytes, microglial cells and neurons also expressed hIL-10 protein after hIL-10 mRNA LNP injection up to 5 days in the injured spinal cord. The mRNA treatment induced time-delayed expression of TIMP-1 and CNTF in injured spinal segment.

These results demonstrate that the delayed hIL-10 treatment is able to induce morphological and functional improvement after spinal cord contusion. The hIL-10 mRNA LNP provides a simple and controllable new therapeutic approach that is less-invasive than other treatments and does not integrate into the genome.

Poster Topic

T4: Neurotransmitters, Retrograde messengers and Cytokines

- [T4-1A](#) Autophagosome transport in Noradrenergic axons in-vivo
Ahmed A. Aly, Micheal kreutz , Matthias Prigge, Anna Karpova
- [T4-2A](#) Dissecting functional vesicle pools and serotonin-release kinetics from mouse enterochromaffin cells
Ahmed Shaaban, Jaden Quale, Benjamin Cooper, Cordelia Imig
- T4-1B Retracted
- [T4-2B](#) Hunting of potential coupling factors controlling circadian and ultradian rhythms of feeding by neuropeptidomics and mass spectrometry imaging of neuropeptides from the *Drosophila* brain
Deepika Bais, Susanne Neupert
- [T4-1C](#) Nitric oxide synthase in the CNS and immune system of mosquitoes
Stella Bergmann, Anne Schmitz, Celina Möller, Stefanie Becker, Michael Stern
- [T4-2C](#) Analysis of PARP inhibitors in NMDAR-mediated radio-resistance in breast cancer cells
Jannik Wempe, Raffaella van Heeck, Bodo Laube
- [T4-3C](#) sDarken – Next generation genetically encoded sensors for serotonin
Martin Claus Maria Kubitschke, Monika Müller, Lutz Wallhorn, Mauro Pulin, Manuel Mittag, Stefan Pollok, Tim Ziebarth, Svenja Bremshey, Jill Gerdey, Kristin Carolin Claussen, Kim Renken, Pascal Gneisse, Juliana Groß, Niklas Meyer, Simon Wiegert, Andreas Reiner, Martin Fuhrmann, Olivia Andrea Masseck

Autophagosome transport in Noradrenergic axons in-vivo

Ahmed A. Aly^{1,2}, Micheal kreutz¹, Matthias Prigge², Anna Karpova¹

¹Leibniz institute for neurobiology, Neuronal plasticity , Brenneckestraße 6, 39118 magdeburg, Germany

²Leibniz institute for neurobiology, Neuronal Network, Brenneckestraße 6, 39118 magdeburg, Germany

Locus coeruleus (LC) neurons posit an extreme example of long-range axonal projections with excessive branching of axon terminals throughout the brain. The number of noradrenergic synaptic boutons is huge, neurons are tonically active and their distance from the cell body where most protein synthesis and degradation occur is immense. Furthermore, because neurons are both postmitotic and long-lived, maintaining the integrity of their proteome is a challenge in general, particularly in LC neurons. Autophagy is a degradative system that delivers cytosolic cargo to lysosomes for degradation and nutrient recycling. It is characterized by the formation of double-membrane vesicles that engulf parts of the cytoplasm or damaged organelles and traffics toward a high lysosomal area to form an autolysosome and degrade the internal cargo.

Here we employed the Locus coeruleus - specific labeling technique and 2P in vivo imaging on awake mice. We assessed the mobility of labeled autophagosomes in the PFC region via the transcranial window. To answer whether autophagosomes are transported along noradrenergic axons from the PFC to stomata of the Locus coeruleus for the delivery of cytosolic cargo to lysosomes for degradation we employed photoconvertible mEOS4.16 fused to LC3b. We implanted the optical fiber into the PFC, performed photoconversion by 405nm laser power for 10 mins, and sacrificed the animals one hour after photoconversion. As expected, we found significant redistribution of the photoconverted “Red” puncta that were not colocalized with the “Green” one within the somatic region of the Locus coeruleus indicating the existence of long-distance axonal trafficking of autophagic vesicles in noradrenergic projections.

Dissecting functional vesicle pools and serotonin-release kinetics from mouse enterochromaffin cells

Ahmed Shaaban¹, Jaden Quale¹, Benjamin Cooper², Cordelia Imig¹

¹University of Copenhagen, Department of Neuroscience, Blegdamsvej 3b, 2200 Copenhagen, Denmark

²Max Planck Institute for Multidisciplinary Sciences, Department of Molecular Neurobiology, Hermann-Rein-Str. 3, 37075 Goettingen, Germany

Enteroendocrine cells (EECs) are a group of cells specialized in sensing a wide range of stimuli, which include bacterial metabolites, toxins, and mechanical stimulation, and in transducing these stimuli into signals to the brain via the release of peptide hormones and neurotransmitters. A subtype of EECs referred to as Enterochromaffin (EC) cells produce and release more than 90% of the body's serotonin (5-HT), which is an important regulator of various physiological processes including gut motility. EC cell dysfunction has been associated with several disease states such as irritable bowel syndrome, inflammation, nausea, and visceral hypersensitivity. To gain a better understanding of the molecular mechanisms that mediate EC cell function and 5-HT release, we have established an *in vitro* experimental workflow using epithelial 2D-monolayer cultures from a transgenic mouse line that specifically expresses cyan fluorescent protein (CFP) under the control of the Tryptophan hydroxylase 1 (Tph1) promoter, allowing us to identify EC cells in culture for high-resolution functional assays. Using whole-cell patch clamp electrophysiology combined with measurements of changes in membrane capacitance in response to a series of depolarization pulses, and single-cell carbon fiber amperometry, we were able to characterize functional vesicle pools in isolated EC cells from different gut regions and characterize the kinetics of the 5-HT release from individually fusing vesicles. We anticipate that this methodological approach will ultimately make it possible to study EC cell function and 5-HT release from human EC cells in various different disease contexts.

Hunting of potential coupling factors controlling circadian and ultradian rhythms of feeding by neuropeptidomics and mass spectrometry imaging of neuropeptides from the *Drosophila* brain

Deepika Bais¹, Susanne Neupert¹

¹University of Kassel, Animal Physiology/Neuroethology, Heinrich-Plett-Str, 40, 34132 Kassel, Germany

The diurnal adult fruitfly *Drosophila melanogaster* expresses circadian and ultradian rhythms of rest (sleep) and activity (locomotion and feeding) with activity peaks at dusk and dawn. Neuropeptides are coupling factors released from peripheral and central oscillator neurons in ultradian and circadian rhythms entrained to environmental Zeitgebers. They play key roles in the timing of cell-cell communication in neuronal networks that regulate e.g. feeding. As a first step, we collected a comprehensive neuropeptidomic data set obtained by transcriptome analysis of the *Drosophila* central and ventral nervous system (VNC) combined with neuronal tissue extract analysis (brain, VNC, retrocerebral complex) by Q-Exactive Orbitrap mass spectrometry (MS) and direct tissue profiling by matrix-assisted laser desorption/ionization time-of-flight (MALDI-TOF) MS of selected neuronal tissues. We next characterized the spatial distribution of a subset of peptides encoded on different precursor proteins with high resolution by MALDI MS imaging (MALDI-MSI) on 14 μm *Drosophila* brain sections. Our data provide a solid framework for future research into spatially resolved qualitative and quantitative changes in neuropeptide and rhythmically released coupling factors that sense and couple external or internal rhythms at different time scales. [Supported by DFG grants RTG 2749/1 "Multiscale Clocks"]

Nitric oxide synthase in the CNS and immune system of mosquitoes

Stella Bergmann¹, Anne Schmitz¹, Celina Möller¹, Stefanie Becker², Michael Stern¹

¹University of Veterinary Medicine Hannover, Institute of Physiology and Cell Biology, Bischofsholer Damm 15/102, 30173 Hannover, Germany

²University of Veterinary Medicine Hannover, Institute of Parasitology, Bünteweg 17/217, 30559 Hannover, Germany

Arthropods, especially mosquitoes, are vectors for numerous different pathogens. They are becoming an increasing challenge for human health because of increasing distribution of invasive species of both vectors and viruses in times of global warming. Transmission of pathogens is dependent by not only the vector's immune response but also its behaviour, which can be altered by infection through interactions between immune and nervous system. One effector well suited for information transmission between immune and nervous system is the gaseous radical nitric oxide (NO), which functions as a signaling molecule in both systems, and can easily cross barriers between tissues.

In contrast to other insects, there is little information on NO signaling in the mosquito CNS and immune system yet. We study the distribution of NO synthesis in the CNS and immune cells of four mosquito species: *Aedes aegypti*, *Aedes albopictus*, *Culex pipiens quinquefasciatus*, and *Culex pipiens molestus*. General level of NO synthase (NOS) expression was detected and quantified by Western blots. We localised the distribution of NOS by NADPH diaphorase histochemistry, using a fixation regime and staining protocol modified for optimal results on mosquito tissue in whole mounts and vibratome sections. In addition, we used immunofluorescent labelling of the by-product of NO synthesis, citrulline, to confirm the content and activity of NO-synthase in tissues.

In all mosquito species, we saw NOS-positive neuronal profiles distributed in most neuropils of the CNS, with most prominently labelled structures in the optic lobes and the central complex. NOS appeared to be absent from the mushroom bodies. In the ventral nerve cord, a small number of NOS-positive cell bodies, and intensive arborisations in the neuropil could be identified in the abdominal ganglion chain. In the immune system, we found NOS/citrulline positive hemocytes in mosquitoes 24 h after infection with live *E. coli* K12, both accumulated around the ostia of the heart and distributed over the entire abdomen, also in close proximity to the CNS. In control mosquitoes, NOS labelled hemocytes were absent. Furthermore, a small number of cells in the fat body, probably oenocytes, were strongly labelled with NADPH diaphorase and anti-citrulline in both infected and control mosquitoes.

We compare the distribution of NOS in the CNS and immune cells to the situation in *Drosophila* and in the locust, where we could demonstrate a response of CNS neurons to contact with immune-stimulated hemocytes by increased synthesis of cGMP, the canonical second messenger in NO signaling pathways.

We conclude that NO is likely to play an important role in the mosquito CNS and immune system, and that it is a likely candidate to mediate infection-induced behavioural changes in mosquitoes.

Funded by DFG (STE 1428/5-2, BE 5748/1-2).

Analysis of PARP inhibitors in NMDAR-mediated radio-resistance in breast cancer cells

Jannik Wempe¹, Raffaella van Heeck¹, Bodo Laube¹

¹Technical University of Darmstadt, Neurophysiology and Neurosensory Systems, Schnittspahnstraße 3, 64287 Darmstadt, Germany

Breast cancer is the most common cancer in women. One of the major problems in this type of cancer is breast-to-brain metastasis. Poly (ADP-ribose) polymerase (PARP) inhibitors have been successfully used by exploiting synthetic lethality in breast cancer cells deficient in homologous recombination by blocking DNA damage repair and acting synergistically with radiotherapy, chemotherapy, and immunotherapy. It has been shown that the Ca^{2+} -permeable N-methyl-D-aspartate receptor (NMDAR), which is critical for neuronal development and function, can contribute significantly to tumor malignancy by promoting growth, survival, migration, and DNA damage repair. Therefore, NMDAR-dependent signaling pathways are considered promising targets in cancer therapy. Recent results show that NMDARs activate topoisomerase II β (TOP2B), thereby promoting tumor growth and tumor cell invasiveness. In this context, NMDAR-dependent activation of TOP2B imposes site-specific transient DNA double-strand breaks (DSBs) that are required for the expression of early response genes (ERGs), such as the proto-oncogene cFos. TOP2B has been detected in the promoter regions of these genes along with DNA repair proteins such as PARP and DNA-PK. We therefore aimed to investigate whether there is a functional relationship between the DNA-DSB activity of TOP2B and the DNA strand break-dependent activation of PARP enzymes with respect to the expression of ERGs and radio-sensitivity. To answer this question, we performed clonogenic assays using MCF-7 breast cancer cells. Addition of the PARP inhibitor venadaparib resulted in a strong reduction of clonogenic survival after irradiation. Interestingly, stimulation of NMDARs by glutamate resulted in a marked rescue effect. Further, we plan to examine NMDAR-mediated DSBs and expression of ERGs in the presence of PARP inhibitors. Although further studies are needed, our data suggest that NMDAR-dependent signaling pathways play a role in PARP-mediated repair of DNA damage and sensitization of breast cancer cells to radiation. This could be considered another promising target in the therapy of breast-to-brain metastasis.

sDarken – Next generation genetically encoded sensors for serotonin

Martin Claus Maria Kubitschke¹, Monika Müller⁴, Lutz Wallhorn¹, Mauro Pulin³, Manuel Mittag⁴, Stefan Pollok², Tim Ziebarth², Svenja Bremshey¹, Jill Gerdey¹, Kristin Carolin Claussen¹, Kim Renken¹, Pascal Gneisse¹, Juliana Groß¹, Niklas Meyer¹, Simon Wiegert³, Andreas Reiner², Martin Fuhrmann⁴, Olivia Andrea Masseck¹

¹Universität Bremen, Synthetische Biologie, Leobener Str. 5, 28359 Bremen, Germany

²Cellular Neurobiology, Department of Biology and Biotechnology, Ruhr University Bochum, Bochum, Germany

³Synaptic Wiring and Information Processing, Center for Molecular Neurobiology (ZMNH), UKE, Germany

⁴Neuroimmunology and Imaging Group, German Center for Neurodegenerative Diseases (DZNE), Bonn, Germany

The molecule serotonin sparks the interest of scientists for over half a century. Still the direct measurement of serotonin release in the brain is challenging. Here, we report the development of a family of genetically encoded serotonin (5-HT) sensors (sDarkens), which are promising tools to overcome that challenge.

The initial sDarken was created by substitution of a large portion of the third intracellular loop of the 5-HT_{1A} receptor with circular permuted GFP and mutations of specific linker regions flanking the cpGFP. When expressing sDarken in cells, it shows a bright fluorescent signal in the membrane portions in its unbound state. Upon binding of 5-HT, sDarken shows a strong decrease of the fluorescence signal. Based on the initial version, different sensor variants were engineered capable of measuring serotonin within different ranges of concentrations.

Different experiments using sDarken in vitro and in vivo showed the feasibility of imaging serotonin dynamics with high temporal and spatial resolution.

For example, sDarken showed a high specificity for serotonin and ligands of the 5-HT_{1A} receptor. Also, measurements of sDarken revealed fast kinetics for the binding and dissociation of serotonin. The sensor showed excellent membrane expression.

Additionally measurements of serotonin release within the PFC of anesthetized mice using two photon microscopy and simultaneous electrical stimulation of the dorsal raphe were carried out. Furthermore, sDarken was used to detect serotonin dynamics of awake and moving mice using a reward paradigm which suggest that sDarken is sensitive enough to detect natural occurring serotonin dynamics.

Poster Topic

T5: G Protein-linked and other Receptors

- [T5-1A](#) Heterodimerization and interaction of the serotonin-receptors 5-HT1A and 5-HT2C
Imandra Laura Kempe, Michael Koch, Olivia A. Masseck
- [T5-2A](#) Love on a cellular level: The “love-hormone” oxytocin accelerates tight junction formation in 3D spheroids
Benjamin Jurek, Lucia Denk, Nicole Schäfer, Saied Salehi, Sareh Pandamooz, Silke Haerteis
- [T5-1B](#) Modulation of emotional behavior by HCA2 receptor deficiency in chronic skin inflammation
Hagen Lange, Evelyn Gaffal
- [T5-2B](#) The hyaluronan receptor CD44 modulates serotonin receptor 7 signaling
Saskia Borsdorf, Josephine Labus, Andre Zeug, Evgeni Ponimaskin
- [T5-1C](#) The role of brain endothelial $G\alpha_{q/11}$ signaling in the cognitive function of mice
Dimitrios Spyropoulos, Dorothea Ziemens, Anne-Sophie Gutt, Sonja Binder, Markus Schwaninger, Jan Wenzel
- [T5-2C](#) Using Pluripotent Stem Cells as a model to determining expression, function and pharmacology of GLP-1 receptor in human hypothalamic POMC neurons
Simone Mazzaferro, Hsiao-jou Cortina Chen, Andrian Yang, Iman Mali, Matthew Livesey, Peter Kirwan, Sanya Aggarwal, Venkat Pisupati, Matthew Livesey, Florian Merkle

Heterodimerization and interaction of the serotonin-receptors 5-HT1A and 5-HT2C

Imandra Laura Kempe¹, Michael Koch², Olivia A. Masseck³

¹University of Bremen, Synthetic Biology, Leobener Str. 5, 28359 Bremen, Germany

²University of Bremen, Neuropharmacology, Hochschulring 18, 28359 Bremen, Germany

³University of Bremen, Synthetic Biology, Leobener Str. 5, 28359 Bremen, Germany

G-Protein coupled receptors (GPCRs) are one of the most prominent receptors in the central nervous system. Their dysfunction plays a key role in several neurological and neuropsychiatric disorders, which is also why they are a common target for medical treatment. It is, thus, of high importance to deeply understand the functions and mechanisms of GPCRs, in order to create more effective and more specific medical treatment, with less side effects.

This study investigates the possible interplay of the serotonin-receptors 5-HT1A and 5-HT2C, which play a major role in the pathology of depression. Experiments were performed in transfected HEK-293 cells expressing both receptors.

Our study shows first evidence for heterodimerization between the 5-HT1A and 5-HT2C receptor, since we observed FRET in acceptor photobleaching measurements. A significant increase in fluorescence intensity of the CFP-tagged 5-HT2C receptor by appr. 10 % could be detected, after bleaching the YFP-tagged 5-HT1A receptor.

Possible heterodimerization is further analyzed by FLIM and Co-Immunoprecipitation/ Western-Blot.

Love on a cellular level: The “love-hormone” oxytocin accelerates tight junction formation in 3D spheroids

Benjamin Jurek^{1,2}, Lucia Denk², Nicole Schäfer³, Saied Salehi⁴, Sareh Pandamooz⁵,
Silke Haerteis²

¹Max Planck Institute for Psychiatry, Neurobiology of Stress Resilience, Mathias V Schmidt Group, Munich, Germany

²Institute for Molecular and Cellular Anatomy, University of Regensburg, Regensburg, Germany

³Experimental Orthopaedics, Centre for Medical Biotechnology (ZMB), Bio Park 1, University of Regensburg, Regensburg, Germany

⁴Clinical Neurology Research Center, University of Medical Science, Shiraz, Iran

⁵Stem Cells Technology Research Center, University of Medical Science, Shiraz, Iran

Oxytocin (OXT) is a neuropeptide that is also referred to as the “love- and cuddle-hormone”. Besides its pro-social effects, it has been associated with neurological diseases like autism, but also anxiety and stress-related behavior, physiological effects during pregnancy and parenting, and various cellular effects in neoplastic tissue.

In this study, we aimed to unravel the underlying mechanism that OXT employs to regulate cell-cell contacts, and to test a novel approach to antagonize the OXT receptor (OXTR) via antisense oligos (Gapmers). We have generated a labeled OXTR overexpressing cell line cultivated in spheroids that were treated with the OXTR agonists OXT, Atosiban, and Thr4-Gly7-oxytocin (TGOT). Correct membrane expression of the labeled OXTR was confirmed by correlative light electron microscopy (CLEM).

OXTR agonist treated spheroids were analyzed with or without a pre-treatment of Gapmers that induce exon skipping in the human OXTR gene. This exon skipping leads to the exclusion of exon 4 and therefore a receptor that retains its N-terminal ligand binding- and transmembrane domains, but lost its C-terminal intracellular G-protein-binding domain. Sensitive digital PCR (dPCR) provided us with the means to differentiate between wild type and truncated OXTR. As this truncated receptor is unable to transmit signals to the cell, those Gapmers can be used as a novel class of OXTR antagonist with exceptional specificity and efficacy.

OXTR truncation differentially activated intracellular signaling cascades related to cell-cell attachment, cellular migration and proliferation, like Akt, ERK1/2-RSK1/2, HSP27, STAT1/5, and CREB. Digital microscopy and transmission electron microscopy revealed increased tight junction formation and well-organized cellular protrusions into an enlarged extracellular space after OXT treatment, resulting in increased cellular survival. In summary, OXT decreases cellular migration but increases cell-cell contacts and therefore improves nutrient supply. These data reveal a novel cellular effect of OXT that might have implications for degenerating CNS diseases.

Modulation of emotional behavior by HCA2 receptor deficiency in chronic skin inflammation

Hagen Lange¹, Evelyn Gaffal²

¹Institute of Anatomy, Otto-von-Guericke University Magdeburg, Germany

²Department of Dermatology, Otto-von-Guericke-University, Magdeburg, Germany

Chronic inflammatory skin diseases such as atopic dermatitis (AD) and psoriasis are associated with a high co-morbidity with neuropsychiatric disorders like anxiety and depression, suggesting a link between pathophysiological processes in the skin and the brain. G-protein coupled receptors which are expressed on neurons and glial cells in the brain as well as on skin and immune cells, could mitigate such interactions. One such example is the Hydroxy-Carboxylic Acid Receptor (HCA2R). Its main ligands are β -hydroxy-butyrate, a ketone body that is synthesized in the liver in response to fasting/starvation, and the SCFA butyrate, which is the product of bacterial fermentation of dietary fibers in the colon. Activation of the HCA2R has been shown to exert anti-inflammatory effects in the skin, e.g. in the context of treating psoriasis, as well as in the brain for example in the event of acute traumatic brain injury.

In this study, we started by analyzing cytokine expression and neuroinflammation in the prefrontal cortex and the hippocampus of HCA2 $-/-$ mice with and without chronic skin inflammation by qPCR. AD-like skin inflammation was induced by challenging the ear with the hapten DNFB for 14 days and led to the activation of the proinflammatory TH1 pathway. High expression levels of one of the main effector cytokines of this pathway, IFN γ , and its dependent chemokines CCL8 and CXCL10, were observed in the hippocampus of HCA2 $-/-$ mice with a chronic inflammation. While the gene expression levels of glial markers were only marginally regulated by HCA2R deficiency or chronic skin inflammation, the expression of the receptor type 2 of the stress-associated corticotropin-releasing hormone (CRH) was already reduced in the dorsal hippocampal naive HCA2 $-/-$ mice. Moreover, already in HCA2 $-/-$ mice without chronic skin inflammation, the density of the microglia marker Iba1, analyzed by immunohistochemistry, was increased in distinct sublayers of the dorsal hippocampus. We then conducted a variety of behavioral tests to assess general anxiety, social interaction, spatial and fear memory. HCA2 $-/-$ mice showed increased anxiety-like behavior in the open field and in the marble burying test and deficits in contextual fear memory.

Our data suggests, that deficiency of the HCA2 receptor promotes anxiety and disturbs hippocampus-dependent contextual fear memory, putatively by increased hippocampal microinflammation and an altered stress response system. Moreover, the HCA2R also seems to prevent the upregulation of IFN γ and subsequent chemokines in the hippocampus in response to chronic skin inflammation, acting potentially protective against the known to detrimental effects of IFN γ on hippocampal plasticity and cognitive performance. To test this interaction, our study will be continued to investigate the behavioral effects of chronic skin inflammation in HCA2 $-/-$ mice and their impact on neuronal and glial function further. Ultimately, the pharmacological activation of the HCA2 receptor may provide treatment options also for psychiatric co-morbidities of skin inflammation.

The hyaluronan receptor CD44 modulates serotonin receptor 7 signaling

Saskia Borsdorf¹, Josephine Labus¹, Andre Zeug¹, Evgeni Ponimaskin¹

¹Cellular Neurophysiology, Hannover Medical School, Hannover, Germany

The serotonergic system is a key player in the regulation of various brain functions, such as mood, learning, and memory processing. A central mechanism linked to these processes is synaptic plasticity, which involves morphological changes in dendritic spines and reorganization of the extracellular matrix (ECM). Recently, we connected both systems by describing a signaling module involving the serotonin receptor 7 (5-HT₇R) and ECM components. Important physiological consequences of this interplay include dendritic spine remodeling and impairment in synaptic transmission (Bijata et al., Cell Rep, 2017; Bijata et al., Cell Rep, 2022). Interestingly, we discovered not only a co-localization but also a physical interaction between the 5-HT₇R and the hyaluronan receptor CD44, both *in vitro* and *in vivo*.

Here, we investigated whether heteromerization with CD44 influences 5-HT₇R-mediated signaling, including changes in cAMP concentration and activation of downstream effectors. Our analysis revealed that heteromerization results in an increased basal, serotonin-independent activity of the 5-HT₇R whereas the susceptibility to agonist-induced activation is reduced. Unexpectedly, activation of CD44 by hyaluronic acid can further boost the basal activity of the 5-HT₇R in the heteromeric complexes demonstrating that, although CD44 is not able to influence cAMP levels per se, it can modulate 5-HT₇R-mediated cAMP signaling. Finally, we found that expression of 5-HT₇R and CD44 undergoes pronounced developmental changes in different brain areas, suggesting that a regulated and balanced ratio of heteromerization in neurons might be crucial for regulating receptor functions during brain development.

The role of brain endothelial $G\alpha_{q/11}$ signaling in the cognitive function of mice

Dimitrios Spyropoulos¹, Dorothea Ziemens¹, Anne-Sophie Gutt¹, Sonja Binder¹, Markus Schwaninger¹, Jan Wenzel¹

¹University of Lübeck, Institute for Experimental and Clinical Pharmacology and Toxicology, Ratzeburger Allee 160, 23562 Lübeck, Germany

Objective:

Under physiological conditions, cerebral blood flow (CBF) is tightly regulated to meet the energy demands of active brain regions and remove metabolic products like CO₂. In the healthy brain, vessels respond to stimuli like CO₂, with an increase of the brain perfusion, a phenomenon called cerebrovascular reactivity. We have shown recently that the loss of brain endothelial $G\alpha_{q/11}$ signaling in mice leads to impaired cerebrovascular reactivity inducing increased anxiety and reduced respiratory response to CO₂. However, whether this endothelial dysfunction affects memory and learning in mice is not known. In this project, we aimed to investigate the cognitive function during the lifespan of mice lacking brain endothelial $G\alpha_{q/11}$ signaling.

Materials and Methods:

To investigate the role of the brain endothelial $G\alpha_{q/11}$ signaling in cognitive function, we generated a brain endothelial-specific knockout (beKO) mouse model. More specifically, the bacterial artificial chromosome (BAC)-transgenic *Slco1c1-CreERT2* strain, which expresses the tamoxifen-inducible CreER^{T2} recombinase under the control of the mouse *Slco1c1* regulatory sequences in brain endothelial cells was crossed with the *Gna11* knockout, loxP-flanked *Gnaq* alleles strain ($G\alpha_{q/11}^{\text{beKO}}$ mice). The object place recognition test (OPR) and the Barne's Maze were used to assess the cognitive function of the mice at different time points in their lives. Immunofluorescence stainings and Western blotting from brain samples were used to detect structural and functional differences between genotypes.

Results:

The OPR test of different time points between the age of 2 and 18 months old did not show any differences between the control and the knockout group, although $G\alpha_{q/11}^{\text{beKO}}$ mice did not perform significantly better than chance at 18 months old of age. However, the Barne's Maze on aged mice 20 months old, revealed a significant decrease in cognitive function in the $G\alpha_{q/11}^{\text{beKO}}$ compared to the control group. Immunofluorescence stainings of the cortex on brain sections of 20 months old mice showed no differences between the genotypes regarding the blood-brain barrier integrity, myelination, neuroinflammation markers, and vessel density. However, we found that the knockout group had an increase in empty vascular basement membrane tubes, so-called string vessels, reflecting microvascular pathology. Finally, western blotting from the cortex and the hippocampus showed that the knockout group had increased phosphorylated tau compared to the control group.

Discussion:

In the current project, we found that the specific deletion of the $G\alpha_{q/11}$ signaling in brain endothelium, induces mild cognitive deficits in aged mice but not in younger mice as revealed by behavioral tests.

Moreover, looking for possible mechanisms that underlie these changes we found increased rarefaction and phosphorylated tau protein on the knockout group compared to control group. Ongoing investigation on brain sections from younger mice as well as immunofluorescence staining on the hippocampus of older mice will shed more light on the role of $G\alpha_{q/11}$ signaling in the cognitive function of mice. Overall, our data point towards the significant role of brain endothelial $G\alpha_{q/11}$ signalling in the cognitive function of mice and which could be an important pharmacological target for the age dependent cognitive decline.

Using Pluripotent Stem Cells as a model to determining expression, function and pharmacology of GLP-1 receptor in human hypothalamic POMC neurons

Simone Mazzaferro¹, Hsiao-jou Cortina Chen¹, Andrian Yang^{1,2}, Iman Mali¹, Matthew Livesey³, Peter Kirwan¹, Sanya Aggarwal¹, Venkat Pisupati¹, Matthew Livesey², Florian Merkle¹

¹Wellcome-MRC Institute of Metabolic Science, University of Cambridge, Cambridge, UK.

²European Molecular Biology Laboratory, European Bioinformatics Institute, Wellcome Genome Campus, Cambridge, UK.

³Department of Neuroscience, Sheffield Institute for Translational Neuroscience, University of Sheffield, Sheffield, UK

Glucagon-like peptide (GLP-1) and other incretins play an important biological role in regulating metabolism, in part by acting on neuron populations in the hypothalamus. This circuitry has been well described in mice, where activation of hypothalamic pro-opiomelanocortin (POMC) neurons by GLP-1 receptor agonists promote weight loss by reducing food intake. However, the molecular mechanisms that lead to POMC neuron activation are not fully understood. To address this issue, we generated a knock-in induced Pluripotent Stem Cell (iPSC) line where green fluorescent protein (GFP) is expressed under control of the endogenous POMC promoter, and differentiated this cell line into hypothalamic neurons. We found that GFP was appropriately expressed in human POMC neurons, enabling these cells to be isolated for bulk RNA sequencing and functional studies. This analysis revealed that human POMC neurons are enriched in GLP-1 receptor and express downstream effectors and channels that may mediate its action. We are now profiling the transcriptional responses of these POMC neurons to GLP-1 receptor agonists, and using single-cell patch clamp and calcium Imaging quantify the effect of GLP-1 receptor agonists on the excitability of human POMC neuron and to determine the molecular mechanisms underlying this effect. These studies may reveal molecular targets for further enhancing the appetite-reducing action of GLP-1 receptor agonists.

Poster Topic

T6: Ligand-gated, Voltage-dependent Ion Channels and Transporters

- [T6-1A](#) Characterization of a *Kcna2* loss of function mouse model
Peter Müller, Nikolas Layer, Ahmed Elthoki, Thomas Ott, Holger Lerche, Thomas Wuttke, Ulrike B S Hedrich
- [T6-2A](#) Characterization of the interaction between gephyrin and the full-length glycine receptor
Nele Marie Burdina, Theresa Schneider, Elmar Behrmann, Günter Schwarz
- [T6-3A](#) Effects of increased $\text{Ca}_v1.3 \text{ Ca}^{2+}$ currents in inner hair cells of $\text{Ca}_v1.3\text{-DCRD}^{\text{HA/HA}}$ mice on pre- and postsynapses, hearing, and the consequences of an acoustic trauma
Philipp Maximilian Fischer, Kerstin Blum, Fahmi Nasri, Simone Kurt, Jutta Engel
- [T6-4A](#) Putative roles of NBCe1-KCC2 interaction on KCC2 activity in distinct neuronal maturation stages.
Abhishek Pethe, Anna-Maria Hartmann, Bernd Heimrich, Eleni Roussa
- [T6-5A](#) Investigating putative pacemaker currents in the *Drosophila melanogaster* central nervous system
Anatoli Ender, Davide Raccuglia, David Oswald
- [T6-1B](#) Leptin deficiency leads to functional dysregulation of pacemaker currents in the somatosensory thalamus of the mouse.
Paula Patricia Perissinotti, Florencia Correa, Francisco Urbano
- [T6-2B](#) Localization and function of mutually exclusive exons of the Cav2 channel cacophony in the *Drosophila* visual system
Veronica Pampanin, Tobias Rinas, Lukas Kilo, Carsten Duch, Stefanie Ryglewski
- [T6-3B](#) Probing the role of ion channel degeneracy for robust neuronal excitability
Selina Hilgert, Lion Huthmacher, Silvan Hürkey, Carsten Duch, Stefanie Ryglewski
- [T6-4B](#) Resurrected from obscurity: the forgotten Goldman-Hodgkin-Katz (GHK) current equation: stable spike firing in ultrathin axons.

Oron David Kotler, Michael Gutnick, Ilya Fleidervish
- [T6-1C](#) Reelin-induced modulation of cholinergic signal transmission and posttranscriptional protein

modification

Marie-Luise Kümmel, Eckart Förster

[T6-2C](#) Regulation of the electrogenic $\text{Na}^+/\text{HCO}_3^-$ cotransporter 1 (NBCe1) and the vacuolar H^+ -ATPase (V-ATPase) by hypoxia and acidosis in glioblastoma

Marina Giannaki, Katharina Everaerts, Christine R. Rose, Eleni Roussa

[T6-3C](#) Simulated ion channel variants explain conflicting effects on firing rates depending on neuron type

Lukas Sonnenberg, Jan Benda

[T6-4C](#) TGF- β 2 regulates expression and thr1007 phosphorylation of the K^+ - Cl^- cotransporter 2 in a neuronal maturation-dependent manner

Anastasia Rigkou, Eleni Roussa

[T6-5C](#) Exon specific properties of voltage gated calcium channels

Lukas Kilo, Christopher Bell, Veronica Pampanin, Stefanie Ryglewski

Characterization of a *Kcna2* loss of function mouse model

Peter Müller¹, Nikolas Layer¹, Ahmed Elthoki^{1,2}, Thomas Ott³, Holger Lerche¹, Thomas Wuttke¹, Ulrike B S Hedrich¹

¹Hertie Institute for clinical brain science, Dept. Of Neurology And Epileptology, Tuebingen, Germany

²University of Washington, Department Of Pharmacology, Seattle, United States of America

³University Clinics Tuebingen, Core Facility
Transgenic Animals, Tuebingen, Germany

Monogenetic developmental and epileptic encephalopathies (DEE) are rare diseases that combine behavioural, cognitive and movement abnormalities with often severe epilepsies, thus placing an immense burden on patients. In 2015, our group described several DEE causing de novo variants in the *KCNA2* gene encoding the voltage-gated potassium channel subunit $K_v1.2$, one of them being p.Pro405Leu (P405L). This variant exhibited a dominant negative loss-of-function phenotype due to a dramatic reduction in current amplitude. To study the effect of this variant on neuronal properties and networks as well as possible compensatory and disease-specific mechanisms, we generated a *Kcna2*^{+/^{P405L}} knock-in mouse model.

We combined metabolic and behavioral phenotyping, intracranial video EEG monitoring, immunohistochemistry, whole-cell patch-clamp recordings of excitatory neurons in acute slices of wildtype and heterozygous mice at postnatal day P12-15 as well as transcriptomic analysis via single nuclei RNA sequencing of cortical and hippocampal tissue to understand both epileptogenesis and compensatory changes in this model.

Heterozygous *Kcna2*^{+/^{P405L}} mice exhibited seizures and some died prematurely between one and two months of age. In addition, *Kcna2*^{+/^{P405L}} mice were hyperactive and males displayed underweight. Surprisingly, we found that at P14 the firing frequency of cortical pyramidal cells was similar to wildtype, and the only difference in intrinsic properties was a significant increase in the afterhyperpolarization amplitude. Our transcriptomic data revealed that at P14 epileptogenesis is limited to only excitatory neurons in the entorhinal cortex (EC): Neither cells in the hippocampus nor the cortex exhibited differential expressed genes, although the mutant was missing one cortical cell population all together. Strikingly, we saw an upregulation of non K_v1 potassium channel subunits in the affected cell populations of the EC. This spacially limited change was consistent with data acquired in the video-EEG recordings, implying a focal seizure type.

In conclusion, we established a new mouse model for a loss-of-function variant in *KCNA2*. Our model explains the focal nature of the epilepsy these patients develop and also mimicks some of the behavioral abnormalities found in humans. For the first time we are thus able to pinpoint cellular changes in a specific region, namely the excitatory neurons of the EC, as a transcriptomic correlate for epileptogenesis.

Characterization of the interaction between gephyrin and the full-length glycine receptor

Nele Marie Burdina¹, Theresa Schneider¹, Elmar Behrmann¹, Günter Schwarz^{1,2}

¹Institute of Biochemistry, Department of Chemistry, University of Cologne, Cologne, 50674, Germany

²Center for Molecular Medicine Cologne (CMMC), University of Cologne, 50931 Cologne, Germany

In mature spinal cord and brainstem, fast inhibitory transmission is primarily mediated via glycine receptors (GlyRs). Efficient glycinergic transmission is dependent on the scaffolding protein gephyrin, which anchors GlyRs at the postsynaptic membrane. GlyRs assemble either as homopentamers of α subunits ($\alpha 1 - \alpha 4$) or as heteropentamers of α and β subunits. Synaptic localization of GlyRs critically depends on the incorporation of the β -subunit, as the intracellular cytosolic domain (ICD) of this subunit drives the interaction with gephyrin. However, interaction studies between the GlyR and gephyrin were so far only based on isolated GlyR β -ICD peptides, ignoring the extracellular ligand binding domain and the lipid environment as well as the conformation of the full-length receptor ICDs within the pentameric assembly of the receptor.

Within this study, we characterize the interaction between the heteropentameric full-length GlyR and gephyrin to gain further insight into the complex formation between both full-length proteins. Therefore, we established a purification protocol for the heteropentameric full-length GlyR consisting of $\alpha 1$ and β subunits (GlyR $\alpha 1/\beta$) from insect cells (Sf9). To mimic the lipid environment at the postsynaptic membrane, the receptor was reconstituted into a lipid nanodisc after purification. Surprisingly, the purified GlyR $\alpha 1/\beta$ did not show an interaction with recombinant *E. coli* gephyrin using size exclusion chromatography (SEC). Attempts to pull-down the native GlyR from mouse spinal cord tissue lysates using recombinant *E. coli* gephyrin were also not successful. In contrast, native gephyrin from mouse spinal cord tissue was able to pull-down the recombinant Sf9 GlyR $\alpha 1/\beta$, suggesting that post-translational modifications of gephyrin might play a role for the interaction with the full-length GlyR. Indeed, pull-down as well as SEC studies using in vitro modified recombinant *E. coli* gephyrin variants revealed that cysteine modifications of gephyrin can promote the interaction with the GlyR.

In summary, our data suggest that gephyrin requires post-translational modifications to interact with the full-length GlyR $\alpha 1/\beta$, although its affinity towards isolated GlyR β -ICD peptides was shown to be within the nanomolar range. This leads to the hypothesis that the GlyR ICDs within the full-length receptor adopt a different conformation compared to isolated GlyR ICD-peptides and that additional modifications of gephyrin are required for the interaction.

Effects of increased $\text{Ca}_v1.3 \text{ Ca}^{2+}$ currents in inner hair cells of $\text{Ca}_v1.3\text{-DCRD}^{\text{HA/HA}}$ mice on pre- and postsynapses, hearing, and the consequences of an acoustic trauma

Philipp Maximilian Fischer¹, Kerstin Blum¹, Fahmi Nasri¹, Simone Kurt¹, Jutta Engel¹

¹Saarland University, Department of Biophysics and CIPMM, Buildg. 48, Saarland University, Kirrberger Str. 100, 66424 Homburg, Germany, Kelterstraße 72, 75417 Mühlacker, Germany

$\text{Ca}_v1.3$ channels with a disrupted C-terminal modulatory domain ($\text{Ca}_v1.3\text{DCRD}^{\text{HA/HA}}$) show altered gating behavior in mouse inner hair cells (IHCs), where $\text{Ca}_v1.3$ currents contribute to >90% of the total Ca^{2+} current. IHC Ca^{2+} currents of mice carrying this disruption (HA mice) were 30% larger compared with wildtype (WT) (Scharinger et al., 2015). We hypothesized that the increased Ca^{2+} influx into IHCs of HA mice would cause Ca^{2+} excitotoxicity in IHCs/type I afferents, and that a noise trauma would increase the damage.

Mice aged 7-8 weeks were subjected to white noise (8 – 16 kHz, 106 dB SPL) for 2 h. ABR recordings were performed 2 days before trauma (day -2), directly after the trauma (day 0), and on day 28. Thereafter mice were sacrificed for immunohistochemistry. Ribbons and postsynaptic scaffold proteins of AMPA receptors were labeled with anti-CtBP2 and anti-Homer1, respectively.

ABR hearing thresholds of HA mice were unaltered compared with WT mice at 7 – 12 weeks indicating that subtype Ia (threshold-determining) spiral ganglion neurons innervating part of IHC ribbons were not affected. Ribbon numbers of HA mice were not different compared with WT mice in the apical, medial and midbasal cochlear region but ribbon sizes were reduced by ~30%. In the basal region, the average ribbon number/IHC of HA mice was reduced to ~50% of the WT value suggesting loss of ribbons due to Ca^{2+} excitotoxicity. The number of postsynapses was similar between WT and HA but a reduction by 20 % was found in the basal region. The median number of unpaired postsynapses/IHC amounted to about 1 for all cochlear regions and both genotypes except the basal region of HA mice, where it was as large as 8.

Four weeks after trauma, ribbon numbers were reduced in the mid-to-high frequency regions compared with unexposed control groups of both genotypes. However, trauma did not further reduce the low number of ribbons in HA IHCs in the basal region. Noise trauma led to orphan postsynapses per IHC in the range of 1 - 2 (medial); 4 - 6 (midbasal), and 3 - 5 (basal) in either genotype underlining once more that in our experimental settings postsynapses are more stable to noise trauma than ribbons.

Altered gating of $\text{Ca}_v1.3$ channels in HA mice did not affect synapses of threshold-determining (Ia) fibers. In the basal (>32 kHz) region of HA mice, degeneration of ribbons was observed even without acoustic trauma, yet postsynapses were hardly affected. The noise trauma did not further reduce ribbons in basal HA IHCs suggesting that in our experimental settings ribbons susceptible to a Ca^{2+} overdose were already degenerated by Ca^{2+} excitotoxicity before the trauma was applied.

Supported by DFG SFB 894 (A8 to JE).

Putative roles of NBCe1-KCC2 interaction on KCC2 activity in distinct neuronal maturation stages.

Abhishek Pethe¹, Anna-Maria Hartmann², Bernd Heimrich³, Eleni Roussa¹

¹Department of Molecular Embryology, Institute of Anatomy and Cell Biology, Medical Faculty, Albert-Ludwigs-Universität Freiburg, Albertstrasse 17, 79106, Freiburg, Germany.

²Division of Neurogenetics, School of Medicine and Health Sciences, Carl von Ossietzky University Oldenburg, Oldenburg, Germany.

³Department of Neuroanatomy, Institute of Anatomy and Cell Biology, Medical Faculty, Albert-Ludwigs-Universität Freiburg, Albertstrasse 17, 79106, Freiburg, Germany.

The K⁺/Cl⁻ cotransporter 2 (KCC2), a protein exclusively expressed in neurons, mediates the extrusion of K⁺ and Cl⁻ from the cell. The developmental shift of GABA from excitatory in immature neurons to inhibitory in mature neurons is mainly due to a developmental upregulation of KCC2. The electrogenic Na⁺/HCO₃⁻ cotransporter 1 (NBCe1) is a protein encoded by the *Slc4a4* gene and responsible for transporting Na⁺ and HCO₃⁻ across the cell membrane, and is a major contributor to the regulation of intra- and extracellular pH. NBCe1 has been hinted at as a putative interaction partner of KCC2 in plasma membranes of adult mouse forebrain. The aim of the present study was to investigate a putative functional role of KCC2-NBCe1 interaction.

Primary mouse hippocampal immature neurons at day *in vitro* (DIV) 4, isolated from E17.5 mouse embryos, organotypic hippocampal slice cultures from postnatal day 2 *Slc4a4* knockout and wildtype mouse pups at DIV17 and DIV35, crude membranes isolated from adult mouse brain slices, and HEK233 cells transfected with KCC2_{WT} (HEK_{KCC2}) were used. Staurosporine (STP; 10μM, 15 minutes), 4-aminopyridine (4AP; 100μM, 60 minutes) and S0859 (50μM, 30 minutes), an NBC inhibitor, were used for treatments.

Co-immunoprecipitation revealed an interaction between KCC2 and NBCe1 in both immature neurons as well as in adult mouse brains. This interaction was significantly less in brain slices treated with 4AP, compared to untreated controls. Immunoblotting (IB) revealed that STP treatment in immature neurons leads to a significant downregulation of pKCC2-S940 and pKCC2-T1007, while not affecting KCC2 whole protein expression. There was also a significant decrease of pKCC2-S940 in neurons treated with STP in the presence of S0859, compared to neurons treated only with S0859, but not in the expression of pKCC2-T1007. STP treatment caused an increase in KCC2 activity in HEK_{KCC2} cells, an effect prevented in the presence of S0859. Treatment of DIV17 mouse organotypic hippocampal slice cultures with 4AP did not have any effect on KCC2 protein expression. However, at DIV35, in wildtype, 4AP treatment led to a significant downregulation of KCC2 protein expression, compared to untreated controls, but not in *Slc4a4* knockout. Moreover, the baseline KCC2 protein expression was also significantly less in *Slc4a4* knockout compared to wildtype.

The above observations suggest a context-dependent and neuronal maturation-dependent differential significance of KCC2-NBCe1 interaction on KCC2 activity.

Investigating putative pacemaker currents in the *Drosophila melanogaster* central nervous system

Anatoli Ender^{1,2}, Davide Raccuglia¹, David Oswald^{1,2}

¹Charité - Universitätsmedizin, corporate member of Freie Universität Berlin and Humboldt - Universität zu Berlin, Institute of Neurophysiology, Charitéplatz 1, 10117 Berlin, Germany

²NeuroCure, Charité - Universitätsmedizin, corporate member of Freie Universität Berlin and Humboldt - Universität zu Berlin

Sleep behavior is highly conserved across the animal kingdom and can be observed in vertebrates as well as in invertebrates. In *Drosophila melanogaster* sleep manifests in sustained periods of quiescence and an increased arousal threshold. Recently, we discovered slow wave oscillations that can be associated with sleep need. These oscillations can be measured in the R5 network of the ellipsoid body, a set of 10-12 cells per hemisphere, which encodes sleep drive. The power of the network oscillations increases with sleep need and exhibits diurnal variations. We find that at a single cell level R5 neurons discharge slow rhythmic bursts of action potentials at frequencies at around 1 Hz.

Periodic activity patterns of cells are often generated by intrinsic membrane currents. In the present study we aim to identify putative pacemaker currents in the R5 system.

We use *in vivo* patch clamp recordings to characterize the neuronal intrinsic properties and the mechanisms underlying the rhythmic firing pattern of R5 neurons. Furthermore, we utilize ion channel specific RNAi lines and pharmacological approaches to identify the channels which are critical for local spontaneous oscillations.

First recordings showed network independent activity in R5 neurons which correlates to the animals' sleep need. Furthermore, our results indicate that the *Drosophila* T-type Cav3 channel is involved in the cell intrinsic pacemaking mechanism of R5 neurons. Eventually, we aim to understand the role of the identified ion channels and their pacemaking function on the behavior of the animals.

Leptin deficiency leads to functional dysregulation of pacemaker currents in the somatosensory thalamus of the mouse.

Paula Patricia Perissinotti¹, Florencia Correa¹, Francisco Urbano¹

¹IFIBYNE - CONICET, Universidad de Buenos Aires, Ciudad Universitaria, C1428 Buenos Aires, Argentina

The ventrobasal (VB) is the main somatosensory relay nucleus in the thalamus. The hypothalamus has been described as the key site of leptin signaling in the brain, promoting satiety and controlling energy homeostasis. However, the heterogeneous distribution of leptin receptors in the central nervous system suggests a role for leptin as a neuromodulator that goes beyond the control of food intake and body weight. Our group reported trophic effects of leptin on the murine thalamocortical somatosensory circuit: alterations in the inhibition/excitation balance on neurons of the VB nucleus, trophic effects during the development of the thalamocortical circuitry and deficits in GABAergic neurotransmission from the thalamic reticular nucleus in the ob/ob mouse (obese, leptin-deficient mouse) (Perissinotti et al., 2018; Brain Structure and Function, DOI:10.1007/S00429-018-1645-X). Here, we studied the electrophysiological expression of pacemaker currents in ventrobasal (VB) neurons in brain slices from wildtype (WT) and the leptin-deficient mouse (ob/ob). The Hyperpolarization-activated Cyclic Nucleotide-gated (HCN) and KV7 (M) are voltage-gated ion channels that carry H and M currents, respectively. The expression of HCN1-4, Kv7.2 and Kv7.3 isoforms is abundant in the thalamus. Both channels are activated at subthreshold potentials and have biophysical properties that mirror each other. Because of their opposite voltage dependencies and directions, they both function similarly as intrinsic, slow 'voltage clamps', tending to stabilize the resting membrane potential (RMP) by opposing depolarizing or hyperpolarizing inputs. Subtle modifications of RMP impact on T-type calcium channels, and this has profound consequences for action potential (AP) generation. We found that development of the thalamocortical system in the absence of endogenous leptin alters the functional expression of HCN, t-type and M-type channels in the VB nucleus. HCN current density decreased by 22% (WT, n=23; ob/ob=22) and its time constant of deactivation was increased in the ob/ob mouse (WT, n=14; ob/ob, n=20). T-type current density decreased by 37% in the ob/ob mouse ((WT, n=9; ob/ob=13). In addition, the steady state activation curve of the T-type current was shifted towards depolarized values, whereas the steady state inactivation curve was shifted towards hyperpolarized ones. At RMP the fraction of T-type channels which do not fully inactivate and therefore remain open approximately decreased by 30% in leptin-deficient VB neurons. On the other hand, the M-type channel blocker XE991 increased the firing frequency of VB neurons from the WT, whereas no effects were observed in the ob/ob mouse. A fine balance between HCN, M-type and T-type channels could regulate neuronal intrinsic excitability. In fact, we observed that the tonic firing mode (transmission mode) was favored in VB neurons from the ob/ob mouse.

Localization and function of mutually exclusive exons of the Cav2 channel cacophony in the *Drosophila* visual system

Veronica Pampanin¹, Tobias Rinas¹, Lukas Kilo², Carsten Duch¹, Stefanie Ryglewski¹

¹Johannes Gutenberg-University of Mainz, Institute of Developmental Biology and Neurobiology, 55128 Mainz, Germany

²University of Bonn, German Center for Neurodegenerative Diseases, 53115 Bonn, Germany

Voltage-gated calcium channels fulfil numerous important functions in different neuronal compartments, ranging from SV release from axon terminals, to shaping the action potential in axons, and affecting dendritic computations of synaptic input, and many more. Consequently, the VGCCs functions largely outnumber the genes encoding these channels. In vertebrate 10 genes encoding $\alpha 1$ subunits of VGCCs are categorized into three families (Cav1-Cav3). In *Drosophila melanogaster* only one gene per family is present. Moreover, the *Drosophila* Cav2 homolog cacophony, mediates distinctly different functions in the soma, the dendrites, the axon, and the axon terminal of the same neuron (Heinrich, Ryglewski, Sci Rep, 2020) and mediates Cav2 currents with different properties (Ryglewski et al., J Physiol, 2012). Thus, the same gene gives rise to channels with different properties that are targeted to different subcellular compartments to take on different functions. Here, we address the role of alternative Cav2 channel splicing in this process. Cacophony is heavily spliced resulting in at least 18 transcripts. By the excision of single exons of mutually exclusive exon pairs with CRISPR/Cas9 we reduce the isoform variability and analyze the localization and function in an isoform specific manner in the *Drosophila* visual system.

Immunohistochemistry reveals localization of cacophony to all major visual neuropils but differential localizations of specific cacophony exon-out variants especially in the lamina. These findings match our electrophysiological data where photoreceptor potentials are reduced and lamina responses are abolished upon excision of specific cacophony exons, thus indicating a role in both photoreceptor excitability and synaptic transmission. We currently combine double labeling of specific identified cell types and fluorophore tagged cacophony exon out variants with high resolution microscopy to determine both, cell type and subcellular compartment specific expression of different cacophony exons. Together with physiological analysis we expect to unravel the role of alternative Cav2 channel splicing for specific aspects of information processing in the *Drosophila* visual system.

Probing the role of ion channel degeneracy for robust neuronal excitability

Selina Hilgert¹, Lion Huthmacher¹, Silvan Hürkey¹, Carsten Duch¹, Stefanie Ryglewski¹

¹Institute of Developmental Biology and Neurobiology (iDN), Hanns-Dieter-Hüsch-Weg 15, 55128 Mainz, Germany

Correct neural circuit function relies on the synaptic connections between and the intrinsic membrane properties of the participating neurons. This project addresses the mechanisms that robustly tune the membrane properties to the specific function of a neuron. As model we use the five identified flight motoneurons, MN1-5, that innervate the dorsal longitudinal flight muscle in *Drosophila melanogaster*. We have previously studied the ion channel complements and excitability profiles of these neurons. MN1-5 all exhibit typical type 1 firing properties, they fire tonically with smoothly increasing frequencies with input strength. In fact, the linear part of the I/F curves precisely covers the tonic MN firing frequencies relevant for wingbeat power control during flight. MN1-5 always show nearly identical input-output properties within and across animals, but the expression levels of single ion channels can vary by up to 400% (e.g. A-type potassium current amplitudes). We hypothesize that the imprecise expression of many ion channels renders excitability more robust to perturbation than the precise expression of few ion channels.

We started with genetic and acute manipulation of Kv2 homolog Shab delayed rectifier potassium channel. Both, acute blockade with quinidine and Shab-RNAi-knock down targeted to MN1-5 decrease action potential repolarization and broaden the spike, and both increase overall MN excitability. Only negligible differences are observed between acute and permanent genetic manipulation, indicating the absence of compensatory upregulation of other channels. Importantly, despite effects on spike shape and maximum firing frequencies, the typical type 1 excitability profile and the input-output operations in the range relevant to flight (2-20 Hz) are not affected by decreasing Shab current. Therefore, the neurons exhibit functional robustness to reductions of Shab channels by ~70% (knock down efficacy). Similarly, the I-F relationships of MN1-5 remain unaltered upon Shab overexpression, although this increases Shab current on average by 50 % and has significant effects on network function (see poster Hürkey et al.). Functional robustness of MN1-5 input output computations is aided by ion channel degeneracy. Theory based on computational modeling proposes ion channel degeneracy as a possible mechanism to render neuronal excitability robust to fluctuation in the expression levels of single channels (Drion et al., 2015). Our system now allows testing these modeling results by reducing ion channel degeneracy in MN1-5 in vivo. One approach will be to reduce ion channel isoform diversity, and another one to reduce the number of different channels encoding A-type current without changing total A-type current amplitude. Ion channel degeneracy as a means to render neuronal excitability robust would likely also reduce developmental cost, as the imprecise regulation of the expression levels of multiple channels is likely less costly than the precise regulation of few specific channels.

Resurrected from obscurity: the forgotten Goldman-Hodgkin-Katz (GHK) current equation: stable spike firing in ultrathin axons.

Oron David Kotler¹, Michael Gutnick², Ilya Fleidervish¹

¹Department of Physiology and Cell Biology, Faculty of Health Sciences and Zlotowski Center for Neuroscience, Ben-Gurion University, Beer-Sheva 84015, Israel

²Koret School of Veterinary Medicine, The Hebrew University of Jerusalem, Rehovot 76100, Israel

In the 1940's and 1950's, two equations emerged that describe the relationships between current and voltage across a membrane. They assumed a constant electric field ¹, and recognized the fact that current flows both ways through the membrane, in accordance with the ionic concentration gradient and the voltage drop. The more famous equation, the GHK voltage equation, reconciled the Nernst potentials of the various ion species with their partial permeability ². The other, the GHK current equation, described the non-linear relationship between current and voltage for different concentration gradients. This equation is only the equivalent of Ohm's law if there is no concentration gradient ^{3,4}. Hodgkin and Huxley, who did not have the benefit of modern computers, used a simplified linear model for their equations, and this estimation fit their data well ⁴. However, under conditions in which the Na concentration gradient changes drastically, such as high frequency repetitive firing in very thin axons, the linear model predicts dire consequences for the fidelity of spike initiation and propagation. Most computational studies have used the linear estimations of the HH equation to determine the effect of changing the Na concentration gradient, and thus have concluded that in compartments with small volumes, spike activity may lead to a rapid increase in intracellular Na concentration and thereby severely compromise spike propagation ^{5,6}. Of course, the current voltage relationship must be affected to some extent by a decreased Na gradient. However, we now show that when the relationship is described using the GHK current equation, the non-linear curve is barely affected in the voltage range relevant to the action potential. Thus, whereas the linear model predicts that a 10-fold increase in intracellular Na concentration leads to an 80% decrease in inward current at 0 mV and an equivalent slowing of the rate of rise of an action potential, the non-linear GHK current equation predicts only about a 20% change. This dramatic difference is significant, because so much of the recurrent activity in many brain areas is via axons with diameters smaller than .5 microns. Since experimental access to these compartments is very limited, we must rely on computational models for insight. In summary, by placing the voltage range of the action potential in a region that is relatively resistant to changes in Na concentration gradient, evolution has ensured stable interaction of neurons in highly active complex local networks.

1. Goldman, D. E. POTENTIAL, IMPEDANCE, AND RECTIFICATION IN MEMBRANES. *Journal of General Physiology* 27, (1943).

2. Hodgkin, A. L. & Huxley, A. F. A quantitative description of membrane current and its application to conduction and excitation in nerve. 1952. *Bulletin of mathematical biology* 52, 25–71; discussion 5-23 (1990).
3. HODGKIN, A. L. & KATZ, B. The effect of sodium ions on the electrical activity of giant axon of the squid. *The Journal of physiology* 108, (1949).
4. HODGKIN, A. L. & HUXLEY, A. F. Currents carried by sodium and potassium ions through the membrane of the giant axon of *Loligo*. *The Journal of physiology* 116, (1952).
5. Zang, Y. & Marder, E. Interactions among diameter, myelination, and the Na/K pump affect axonal resilience to high-frequency spiking. *Proceedings of the National Academy of Sciences* 118, (2021).
6. Coggan, J. S., Sejnowski, T. J. & Prescott, S. A. Cooperativity between remote sites of ectopic spiking allows afterdischarge to be initiated and maintained at different locations. *Journal of Computational Neuroscience* 39, (2015).

Reelin-induced modulation of cholinergic signal transmission and posttranscriptional protein modification

Marie-Luise Kümmel¹, Eckart Förster¹

¹Ruhr-University Bochum, Department of Neuroanatomy and Molecular Brain Research, Universitätsstraße 150, 44801 Bochum, Germany

Reelin, an extracellular matrix protein named after the *reeler*-mutant mouse, exerts key functions in both the developing and the adult brain. During early cortical development, reelin is secreted by Cajal-Retzius cells and acts as a central regulator of neuronal migration, while in the postnatal brain it is expressed by interneurons and modulates synaptic transmission. Previous work on reelin-induced changes of neuronal signaling has shown that reelin signaling interferes with both excitatory glutamatergic and inhibitory GABAergic signaling, for instance by modulating neurotransmitter receptor phosphorylation and the intracellular crosstalk between the synapses and the nucleus. These previous findings give rise to the idea that reelin regulates neuronal signaling by triggering intracellular regulatory processes via modulations on a transcriptional and posttranslational level.

In our project we want to investigate reelin-modulated neuronal signaling by focusing on the cholinergic system. Although projections of the cholinergic system modulate neurons in several different brain regions including the hippocampus, the impact of reelin on the cholinergic signal transmission in the cortex has so far not been examined. Our preliminary results using the calcium imaging of single neurons show a reduction of acetylcholine-induced calcium signals in the presence of reelin when compared to control. We will now analyze this effect in more detail by using proteomics, western blotting and immunofluorescent staining. Our goal is to identify the underlying molecular mechanisms and signaling pathways and to answer the question whether the modulation of acetylcholine-induced calcium signals by reelin also depends on altered posttranscriptional protein modifications. With this project, we want to explore and elucidate the role of reelin in modulating neuronal signal transmission in the postnatal brain. Our findings will contribute to a better understanding of the interplay between neuronal signaling and posttranslational protein modifications, in particular in the context of cholinergic signal transmission.

Regulation of the electrogenic $\text{Na}^+/\text{HCO}_3^-$ cotransporter 1 (NBCe1) and the vacuolar H^+ -ATPase (V-ATPase) by hypoxia and acidosis in glioblastoma

Marina Giannaki¹, Katharina Everaerts², Christine R. Rose², Eleni Roussa¹

¹Institute of Anatomy and Cell Biology, Department of Molecular Embryology, Albert-Ludwigs-University Freiburg, D-79104 Freiburg, Germany

²Institute of Neurobiology, Heinrich Heine University Düsseldorf, D-40225 Düsseldorf, Germany

Glioblastoma multiforme (GBM), also known as grade IV astrocytoma, is the most aggressive and highly invasive variant of malignant glioma. GBM is highly heterogeneous and contains glioma stem-like cells. Due to increased metabolism, cancer cells exhibit pH gradient reversal between extracellular and intracellular space compared to healthy tissue. In tumors, intracellular pH is mildly alkaline, which results in increased cell proliferation and reduced apoptosis, whereas extracellular pH is acidic supporting tumor cell migration and invasion. Based on these observations, expression and activity of key pH regulatory proteins, such as the electrogenic sodium bicarbonate cotransporter 1 or 2 (NBCe1 or NBCe2), the electroneutral sodium bicarbonate cotransporter (NBCn1) and the vacuolar H^+ -ATPase (V-ATPase) might be altered. The aim of the present study is to investigate the effect of hypoxia and extracellular acidosis on the protein expression of different subunits (ATP6V1A, ATP6V1G1, ATP6V1E1 and ATP6V1B2) of V-ATPase as well as the expression and activity of NBCe1 in different glioblastoma stem cell types and elucidate the underlying molecular pathways.

Therefore, cells from two different glioblastoma stem cell lines, classified as mesenchymal-like (MES), hypoxia-dependent and hypoxia-independent were exposed to chemical hypoxia and extracellular acidosis. Hypoxic conditions were established by the use of 200 μM CoCl_2 for 24 hours. For the induction of acidosis additionally to chemical hypoxia, cells were cultured in medium with low bicarbonate concentration (6.1 mM NaHCO_3 and pH 6.8). Immunoblotting and intracellular pH recordings with the H^+ -sensitive dye 2',7'-bis-(carboxyethyl)-5-(and-6)-carboxyfluorescein (BCECF) were applied.

The results showed that in MES-like hypoxia-dependent cells, exposure to hypoxia did not alter protein expression of NBCn1 and NBCe2, but significantly increased NBCe1 protein and activity. This effect was prevented by extracellular acidification, was positively correlated with HIF-1 α protein levels and mediated by TGF- β signaling. Moreover, in MES-like hypoxia-independent GBM cells, acidosis together with hypoxia, but not hypoxia alone significantly decreased NBCe1 activity in an HIF-1 α -independent manner, although the protein expression of the transporter was unaffected. In both MES-like GBM cell lines, chemical hypoxia did not regulate protein abundance of V-ATPase subunits investigated. In contrast, in response to chemical hypoxia accompanied by extracellular acidosis, the V-ATPase subunits showed different regulation patterns between the two MES-like GBM cell lines: during acidosis, in MES-like hypoxia-dependent GBM cells, ATP6V1A and ATP6V1G1 protein abundance was significantly reduced, compared to untreated controls while, in MES-like hypoxia-independent GBM cells only the expression of ATP6V1E1 was significantly decreased, compared to untreated controls.

These results suggest a cell-specific regulation of NBCe1 and V-ATPase subunits in response to hypoxia and acidosis. Based on the above observations, differences in pH-regulatory protein expression in response

to changes of extracellular microenvironment reflect the heterogeneous transcriptional landscapes of cell populations in glioblastoma.

Simulated ion channel variants explain conflicting effects on firing rates depending on neuron type

Lukas Sonnenberg¹, Jan Benda^{1,2}

¹University of Tübingen, Neuroethology Lab, Institute for Neurobiology, Tübingen, Germany

²Bernstein Centre for Computational Neuroscience, Tübingen, Germany

A variety of neurological diseases like epilepsy, pain disorders, ataxia or intellectual disorders are caused by variant ion channels.

The effects of these variants on ionic current kinetics can be readily assessed in heterologous expression systems. The observed changes in gating kinetics are then interpreted to either increase or decrease neuronal excitability and are accordingly classified as gain (GOF) or loss of function (LOF). When measured in real neurons, however, variants may cause increased firing in some types of neurons and decreased firing in others. In other cases, the same changes in channel kinetics cause epilepsy in some patients and autism in others, each associated with opposing changes of neuronal excitability.

In this work, we simulated two cases in which such conflicting behaviours were observed. We identified different mechanisms that explain opposing effects on neural excitability based on other, unaffected ionic currents expressed in a neuron.

In the first case we simulated a variant with a right-shifted sodium activation curve and a faster sodium inactivation. When regarded separately, the first change leads to a LOF while the second causes a GOF. Whether the one or the other dominates neuronal excitability when both changes are applied depends on the conductivity of other, unaffected subthreshold currents. In the second case, the variant had a GOF at low currents, but went into a depolarization block at higher currents. The current needed for the depolarization block was also dependent on other neuronal background parameters.

These examples demonstrate the importance of the ionic current composition of different neuron types in assessing the effects of ion channel variants on neuronal excitability.

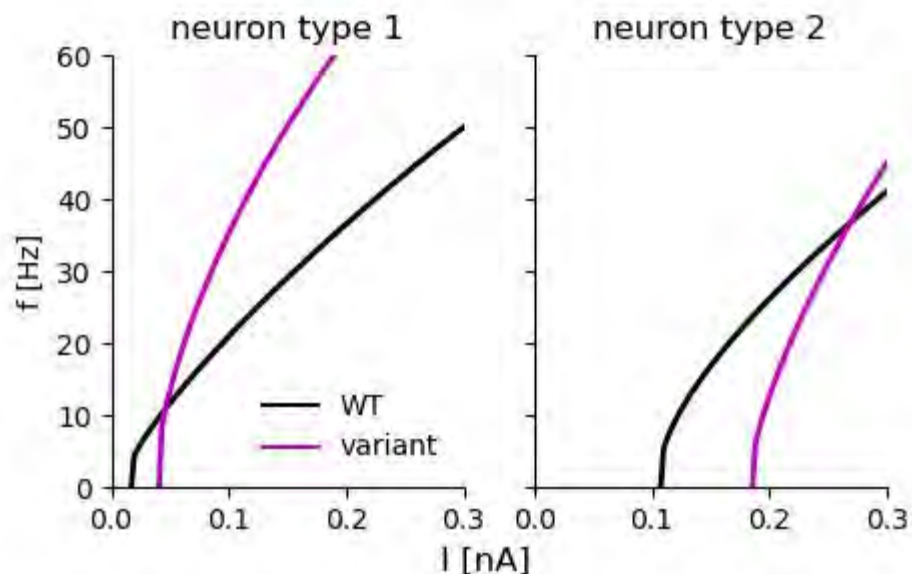

Neuron type determines the effect of the same variant on firing behaviour

TGF- β 2 regulates expression and thr1007 phosphorylation of the K⁺-Cl⁻ cotransporter 2 in a neuronal maturation-dependent manner

Anastasia Rigkou¹, Eleni Roussa¹

¹Institute for Anatomy and Cell Biology, Department of Molecular Embryology, Faculty of Medicine, Albert-Ludwigs-Universität Freiburg, Albertstr. 17, 79104 Freiburg im Breisgau, Germany

Neuron-specific K⁺-Cl⁻ cotransporter 2 (KCC2) mediates potassium and chloride extrusion in mature central nervous system and determines the developmental switch of GABAergic transmission from excitatory to inhibitory. Impairments in KCC2 expression and function are linked to the pathogenesis of several neurological disorders, such as epilepsy. Although plethora of studies have made progress in understanding transcriptional and post-translational control of KCC2, the molecular mechanisms underlying KCC2 regulation are not thoroughly elucidated. We have previously reported that transforming growth factor beta 2 (TGF- β 2) regulates membrane trafficking and functionality of KCC2 in developing and mature hippocampal neurons via CREB-Rab11b signaling.

In the present study, we sought to investigate different levels of KCC2 regulation (transcriptional and post-translational) by TGF- β 2 during neuronal maturation. We performed quantitative PCR, immunoblotting, immunofluorescence, chromatin immunoprecipitation and biotinylation of surface proteins in primary mouse hippocampal neurons, forebrain and hindbrain/brainstem tissue and slices from *Tgf- β 2* deficient mice at embryonic day 17.5. At this developmental stage, these brain areas reveal distinct timetables for neuronal development. Brainstem neurons show the earliest maturation, whereas, in forebrain neuronal development is largely delayed.

The results showed that *Kcc2* expression was downregulated by pharmacological inhibition of TGF- β /activin signaling in immature hippocampal neurons *in vitro*. Moreover, blocking of TGF- β /activin signaling resulted in decreased expression of transcription factors with putative binding sites on *Kcc2* promoter, such as *Ap2 β* , *Sp1*, *Egr4* and the Ap1 subunit *c-Fos*. In forebrain of *Tgf- β 2* null embryos, *Kcc2* transcript and protein were downregulated compared to wildtype littermates, and a decrease in transcription factor *Ap2 β* transcript was observed as well. Chromatin immunoprecipitation revealed binding of AP2 β on *Kcc2* promoter in *wildtype* forebrains which was not present in *Tgf- β 2* null embryos. Hindbrain/brainstem of *Tgf- β 2* null embryos displayed increased phosphorylation of KCC2 at threonine 1007, whereas total KCC2 protein was similar to *wildtype* littermates. In *wildtype* embryos, neurons of the pre-Bötzing complex, a nucleus responsible for respiratory rhythm generation, KCC2 was present on the plasma membrane, as shown by confocal microscopy. In *Tgf- β 2* deficient embryos the number of pre-Bötzing complex neurons expressing membrane KCC2 was reduced by 50% compared to *wildtype* littermates. Increased KCC2 phosphorylation at thr1007 and impaired membrane abundance were abolished after treatment of acute brainstem slices with recombinant human TGF- β 2.

Taken together, these results demonstrate numerous and differential effects of TGF- β 2 on KCC2 in neurons of different maturation stages. In immature neurons, TGF- β 2 contributes to *Kcc2* transcription possibly via AP2 β , whereas in early differentiated neurons in the brainstem, it exerts post-translational control on KCC2 by modulating thr1007 phosphorylation and its membrane abundance. Our data provide novel insight in KCC2 regulation by TGF- β 2. We, therefore, propose TGF- β 2 as a major regulator of KCC2 with putative implications during pathophysiological conditions.

Exon specific properties of voltage gated calcium channels

Lukas Kilo¹, Christopher Bell², Veronica Pampanin², Stefanie Ryglewski²

¹Deutsches Zentrum für Neurodegenerative Erkrankungen e. V. (DZNE) (Bonn), Venusberg-Campus 1/99, 53127 Bonn, Germany

²Institute of Developmental Biology and Neurobiology, Johannes Gutenberg University of Mainz, Hanns-Dieter-Hüsch-Weg 15, 55128 Mainz, Germany

Voltage gated calcium channels (VGCCs) fill many different roles throughout the nervous system, e.g. vesicle release at the synapse, modulating synaptic input in the dendrites or affect gene transcription to name but a few. In vertebrates, the pore-forming α_1 -subunits of VGCCs are mediated by three gene families (Ca_v1 - Ca_v3) with a total of 10 genes. The functional requirements for VGCCs vastly exceed the raw gene number. This is even more pronounced in the *Drosophila* genetic model system, which contains only one homologous gene to each vertebrate VGCC family. One mechanism to resolve this discrepancy is alternative splicing. To explore this possibility, we designed a CRISPR/Cas9 mediated exclusion approach, thereby removing a single exon at a time. In this study, we focus on the Ca_v2 homolog *Dmca1A*, also named *cacophony*. Our approach reduces *cacophony* isoform variability and thus enables isoform specific analysis. We focused on one exon pair that is spliced mutually exclusively and encodes the fourth transmembrane domain (S4) of the first homologous repeat (IS4a/b), which is part of the voltage sensor. We found that the correct expression of either IS4A or IS4B were necessary for proper locomotor function and survival. Animals lacking the A variant for the IS4 locus showed a severely reduced lifespan as well as strongly impaired locomotor behaviors, such as climbing, courtship and flight. By imaging endogenously tagged *cacophony*, across several different tissues of the adult *Drosophila* nervous system, we could show that these defects do not stem from an overall lack of *cacophony* expression.

In contrast, the loss of the B exon of the IS4 locus resulted in homozygous lethal animals. Here the expression patterns were very sparse throughout the animal when examined in heterozygous animals. Expression of *cacophony* lacking the IS4B exon over a *cacophony* null mutation in identified flight motoneurons in an otherwise heterozygous background revealed a loss of synaptic transmission. This indicates that lethality may be caused by the absence of the relevant *cacophony* channels from the pre-synapse. Trans-heterozygous animals, carrying both isoform-reduced variants, were able to rescue the behavioral phenotypes and life span. Upon further investigation of these isoform reduced animals using electrophysiology and calcium imaging in pupal and adult motoneurons, we could show that *cacophony* channels incorporating IS4B activate at ~ 20 mV more hyperpolarized potentials. This coincides with a relative increase in calcium influx upon stimulation in identified motoneurons.

In conclusion, these findings suggest a division of labor across *cacophony* isoforms, with the *cacophony* channels incorporating IS4B mediating the majority of current, while channels incorporating IS4A are needed to fine tune the activation potential of the total *cacophony* mediated current by acting as a throttle. Thus, channels incorporating these two alternatively spliced exons possibly cooperate to ensure proper neuronal function and life span.

Poster Topic

T7: Synaptic Transmission, Pre- and Postsynaptic organization

- [T7-1A](#) A novel player in shaping synapses, the coxsackievirus and adenovirus receptor
Jacobo López Carballo, Rene Jüttner, Michael Götthardt
- [T7-2A](#) Alternative splicing of a voltage-gated calcium channel increases synaptic function in *Drosophila melanogaster*
Christopher Bell, Lukas Kilo, Jashar Arian, Carsten Duch, Stefanie Ryglewski
- [T7-3A](#) Astrocytes regulate network activity in the developing somatosensory cortex of the glutamic acid decarboxylase 67 (GAD67)-GFP mouse
Timo Ueberbach, Clara Simacek, Sergei Kirischuk, Thomas Mittmann
- [T7-4A](#) Characterizing the role of the presynaptic protein CAPS in serotonin release from enterochromaffin cells
Sudeeksha Tyagi, Ahmed Shaaban, Sabine Beuermann, Frederike Maaß, Benjamin H. Cooper, Cordelia Imig
- [T7-5A](#) Cooperative presynaptic functions of synaptotagmin 7 and Cav1 channels at the *Drosophila* neuromuscular junction
Jashar Arian, Selina Hilgert, Carsten Duch
- [T7-6A](#) Determining the number and organization of active zone proteins at the rod ribbon synapse with 3D-MINFLUX
Chad Grabner, Isabella Jansen, Christian Wurm, Tobias Moser
- [T7-7A](#) Developmental Changes in Function of Vasoactive Intestinal Peptide (Vip)- positive GABAergic Interneurons of the Somatosensory Cortex in Mice
Clara Anna Simacek, Thomas Mittmann
- [T7-8A](#) Differential contribution of mEC and dCA1 to spatial and velocity coding of subicular pyramidal neurons
Hiroshi Kaneko, Dennis Dalügge, Stefan Remy
- [T7-9A](#) Disease-related variations in the UNC13A gene cause presynaptic dysfunction
Siqi Sun, Aisha Ahmad, Mareike Lohse, Jonas D. Sommer, Judith J. Jans, Mišo Mitkovski, Holger Taschenberger, Nils Brose, Anita Rauch, Reza Asadollahi, Jeremy S. Dittman, Noa Lipstein
- [T7-10A](#) Dynamic interplay between Cav2 channels and the presynaptic cytomatrix in mechanisms of

neurotransmission

Michela Borghi, Stephan Weissbach, Anna Fejtova, Martin Heine

- [T7-11A](#) Effects of activin A and enriched environment on GABAergic inhibition in dorsal vs. ventral hippocampus
Maria Jesus Valero Aracama, Fang Zheng, Christian Alzheimer
- [T7-12A](#) Effects of activin on intrinsic excitability and synaptic plasticity of CA1 pyramidal cells differ between dorsal and ventral hippocampus
Marc Dahlmanns, Maria Jesus Valero-Aracama, Fang Zheng, Christian Alzheimer
- [T7-13A](#) Exploration of Mechanisms Governing Formation of Postsynaptic Density Using the PyRID Simulator
Nahid Safari, Christian Tetzlaff
- [T7-14A](#) Gut-to-brain signaling - enterochromaffin cell communication with vagal sensory neurons
Esmira Mamedova, Ahmed Shaaban, Cordelia Imig
- [T7-15A](#) HCN-channel mediated functional changes in Parvalbumin-positive interneurons in the somatosensory cortex of mice following traumatic brain injury
Qiang Wang, Thomas Mittmann
- [T7-16A](#) Investigating nanoscale molecular organisation at cerebellar synapses with superresolution microscopy
Maureen McFadden, Gael Moneron, David DiGregorio, David DiGregorio
- [T7-1B](#) Investigating presynaptic nanoarchitecture using proximity labeling approaches
Mareike Lohse, Siqi Sun, Sofia Elizarova, Olaf Jahn, Nils Brose, Noa Lipstein
- [T7-2B](#) ~~ÁÁÁÁÁÁ~~
- [T7-3B](#) Mapping the orientation of synaptic proteins in mammalian synapses and *Drosophila* NMJs by two-photon polarization microscopy
Maksim Galkov, Komal Patil, Gaia Tavosanis, Martin Fuhrmann, Dirk Dietrich, Susanne Schoch
- [T7-4B](#) Maturation of activity-dependent endocytosis during terminal differentiation of cochlear inner hair cells
Guobin Huang, Stefan Münkner, Jutta Engel, Stephanie Eckrich
- [T7-5B](#) Molecular mechanisms of synaptic vesicle release in Dorsal Root Ganglion neurons
Lucia Rojas, Chungku Lee, JeonSeop Rhee
- [T7-6B](#) Molecular subgroups of mouse cortical VIP neurons – laminar distribution, firing pattern and optical stimulation
Mirko Witte, Flore Schork, Felicita Fischer, Philipp Kolligs, Jenifer Rachel, Felix Preuss, Sandra

Heinzl, Martin Möck, Jochen Staiger

- [T7-7B](#) Nanoscale architecture of the synaptic release site
Sofia Elizarova, Siqi Sun, Noa Lipstein
- [T7-8B](#) Neuronal alternative splicing of gephyrin C4 cassettes modulates condensate formation in vitro and synaptic scaffolding in cultured neurons
Filip Liebsch, Anne Bodenhausen, Fynn Eggersmann, Anna Lütz, Peter Kloppenburg, Günter Schwarz
- [T7-9B](#) Novel mechanisms underlying SynGAP syndrome and new strategies toward therapeutic intervention
Judith von Sivers, Benno Kuroпка, Dietmar Schmitz, Sarah Shoichet, Nils Rademacher
- [T7-10B](#) N-type calcium channels sustain vesicle recruitment at a mature glutamatergic synapse
Magdalena Wender, Grit Bornschein, Simone Brachtendorf, Stefan Hallermann, Jens Eilers, Hartmut Schmidt
- [T7-11B](#) Pentameric assembly of glycine receptor intracellular domains provides insights into gephyrin clustering
Guenter Schwarz
- [T7-12B](#) Presynaptic precursor vesicles originate from the trans-Golgi, promoted by the small GTPase Rab2
Astrid G. Petzoldt, Torsten W. B. Götz, Dmytro Puchkov, Veronika Lysiuk, Stephan J. Sigrist
- [T7-13B](#) Quantifying the synaptic Ca²⁺-binding kinetics of Synaptotagmin-1, the Ca²⁺ sensor for transmitter release in the forebrain
Grit Bornschein, Simone Brachtendorf, Abdelmoneim Eshra, Jens Eilers, Stefan Hallermann, Hartmut Schmidt
- [T7-14B](#) Receptor diversity in cholinergic and GABAergic synapses in *Drosophila*
Eleni Samara, Alexander Borst
- [T7-15B](#) Regulation of presynaptic membrane homeostasis by BAR domain proteins
Agata Witkowska, Tim Berneiser, Volker Haucke
- [T7-16B](#) Regulatory Functions of Extracellular-Signal Regulated Kinases (ERK) in the Contralateral Hemisphere of the Mouse Somatosensory Cortex One-Week after Traumatic Brain Injury
Celine Gallagher, Natascha Ihbe, Thomas Mittmann
- [T7-1C](#) Relaxin' cortical circuits: understanding the effect of relaxin on synaptic transmission within cortical circuits
Sadat Hodzic, Therese Riedemann

- [T7-2C](#) Role of activin signaling in GABAergic inhibition in hippocampal granule cells and its implications in depression
Sriity Melley Sadanandan, Fang Zheng, Liubov S Kalinichenko, Christian P Müller, Christian Alzheimer
- [T7-3C](#) Role of synaptic vesicle refilling on robust synaptic transmission in the auditory system
Erika Pizzi, Jennifer Winkelhoff, Eckhard Friauf
- [T7-4C](#) Sex-dependent BDNF-mediated effects of Fingolimod on the architecture of mouse hippocampal neurons
Aiswaria Lekshmi Kannan, Martin Korte, Marta Zagrebelsky
- [T7-5C](#) Short-term plasticity of non-calyceal inputs in the medial nucleus of the trapezoid body
Laura Console-Meyer, Felix Felmy
- [T7-6C](#) Single-molecule imaging of synaptic vesicle condensates
Christian Hoffmann, Jakob Rentsch, Taka Tsunoyama, Akshita Chhabra, Gerard Aguilar Perez, Franziska Trnka, Marcelo Ganzella, Akihiro Kusumi, Helge Ewers, Dragomir Milovanovic
- [T7-7C](#) Species-specific adaptation for ongoing high-frequency action potential generation in MNTB neurons
Nikolaos Kladisios, Kathrin D. Wicke, Christina Pätz, Felix Felmy
- [T7-8C](#) S-SCAM/MAGI2 is essential for synapse formation
Nina Wittenmayer, Sebastian Kügler, Jeong Seop Rhee, Julio S. Viotti, Thomas Dresbach
- [T7-9C](#) Human iPSC-derived neurons have large presynaptic action potentials
Torsten Bullmann, Andreas Ritzau-Jost, Thomas Kaas, Anne Wöhner, Toni Kirmann, Sila Rizalar, Max Holzer, Jana Nerlich, Christian Geis, Jens-Karl Eilers, Robert Joahannes Kittel, Thomas Arendt, Volker Hauke, Stefan Hallermann
- [T7-10C](#) Synaptic Cleft Proteins Form an Outer Enclosure of the Trans-Synaptic Nanocolumn
Paulina Nemcova, Hannes Beckert, Julia Wolf, Susanne Schoch, Dirk Dietrich
- [T7-11C](#) Synaptic transmission is affected by the lack of plasmalogens
Bárbara Catarina Correia, Jaqueline Zortéa, Pedro Brites
- [T7-12C](#) The alanine-serine-cysteine-transporter 1 provides glycine for inhibitory glycinergic transmission in an auditory brainstem synapse
Lina Hofmann, Eckhard Friauf
- [T7-13C](#) The alternative splicing of P/Q-type calcium channels fine tunes presynaptic properties and neurotransmitter release
Ana Carolina Palmeira do Amaral, Abderazzaq El Khallouqi, Jennifer Heck, Arthur Bikbaev, Melanie Mark, Stefan Herlitze, Martin Heine

- [T7-14C](#) The regulation and impact of microtubule abundance at the *Drosophila* neuromuscular junction.
Dario Andrea Lasser, Hannes Euler, Zeeshan Mushtaq, Jan Pielage
- [T7-15C](#) The secretory pathway protein Sec31 controls composition and function of the presynaptic active zone
Marius A. Lamberty, Kerstin Reim, Jutta Meyer, Olaf Jahn, Robert J. Kittel
- [T7-16C](#) Transcriptional profiling of two nuclei in the mouse auditory brainstem reveals gene sets important for auditory processing
Mirjam Montag, Ayse Maraslioglu-Sperber, Kathrin Kattler, Eckhard Friauf
- [T7-17C](#) Understanding the synaptic basis of dystonia pathogenesis triggered by RIMBP1 mutations
Chiara Olmeo, Joaquin Campos, Niccolò Mencacci, Claudio Acuna

A novel player in shaping synapses, the coxsackievirus and adenovirus receptor

Jacobo López Carballo^{1,2,3}, Rene Jüttner¹, Michael Götthardt^{1,2}

¹Max-Delbrück-Center for Molecular Medicine in the Helmholtz Association (MDC), Berlin, Germany

²Charité – Universitätsmedizin Berlin, Germany

³Neurowissenschaftliche Gesellschaft, Berlin, Germany

The coxsackievirus and adenovirus receptor (CAR) is a cell adhesion protein expressed in the brain with a peak of expression during pre- and perinatal development. CAR has been shown to be localized to dendrites and axons in hippocampal neurons. Furthermore, it interacts with synaptic proteins (PSD-95) as well as proteins of the extracellular matrix (fibronectin, tenascin-R and agrin). Despite these findings, the precise function of CAR in the complex machinery of the synapse has yet to be determined. Here we use scRNA-seq analysis in combination with proteomics and histological techniques to characterize wildtype and CAR knockout (KO) mice. In CAR KO mice, the mature neuronal populations of the perinatal hippocampus are increased and this change is preserved in the adult hippocampal layers. Specifically, the number of pyramidal neurons of the CA1 region as well as the thickness of the stratum pyramidale are raised. Globally, the number of interneurons in the perinatal hippocampus is increased while the number of oligodendrocytes, microglia and astrocytes is reduced. Moreover, the absence of CAR increases the protein levels of the synaptotagmin family and NMDA receptors. The proportions of the NMDA receptor subunits are shifted with an increase of the NMDAR-2B that mediates long-term potentiation (LTP) and long-term depression (LDP). Hence, CAR may play an important role in synaptic plasticity. These findings are in line with published data suggesting that synaptic transmission and plasticity were increased in the absence of CAR and could lead to a better understanding of neurological disorders that affects memory formation.

Alternative splicing of a voltage-gated calcium channel increases synaptic function in *Drosophila melanogaster*

Christopher Bell¹, Lukas Kilo², Jashar Arian¹, Carsten Duch¹, Stefanie Ryglewski¹

¹Johannes Gutenberg University Mainz, Institute of Developmental Biology and Neurobiology (iDN), Hanns-Dieter-Hüsch-Weg 15, 55128 Mainz, Germany

²Deutsches Zentrum für Neurodegenerative Erkrankungen e.V. (DZNE) (Bonn)

Cav2 voltage gated calcium channels (VGCCs) play a key role in synaptic vesicle (SV) exocytosis at presynaptic terminals. Functional synapse diversity and the fine-tuning of release probability are aided by modulating the precise localization, kinetic properties, and Cav2 subtype composition (mainly Cav2.1 and Cav2.2 in vertebrates) at the presynapse. The *Drosophila* genome contains only one Cav2 homolog, also named cacophony, that is subject to alternative splicing. We address the role of alternative *Drosophila* Cav2 channel splicing for synapse function. Two mutually exclusive alternative exon pairs encode the fourth transmembrane segment (S4) of the first homologous repeat (IS4a/b) that is part of the voltage sensor, or the intracellular linker between homologous repeats I and II (I-IIa/b), respectively. We employed CRISPR/cas9 mediated excision of one of the alternative exons at a time to reduce cacophony isoform variability. At the *Drosophila* larval neuromuscular junction (NMJ), knock out of the IS4b exon but not of IS4a abolishes synaptic transmission. This indicates that cacophony variants containing IS4b are essential for synaptic expression and function, while IS4a is not expressed. This is supported by immunohistochemical stainings showing no label if exon IS4b is knocked out. These data indicate that IS4b is imperative for action potential triggered fast synaptic transmission. Furthermore, Ca β accessory subunits (Ca β) play a part in channel targeting and surfacing as well as channel kinetics, while G-protein $\beta\gamma$ -subunits (G $\beta\gamma$) are important for calcium-independent channel inactivation. The binding sites for Ca β and G $\beta\gamma$ reside close to each other in the intracellular linker between homologous repeats I and II. The two alternative and mutually exclusive exons encoding this linker in cacophony channels differ with respect to their ability of binding G $\beta\gamma$: while I-IIb has the respective binding site, I-IIa does not, suggesting differences in channel opening times and thus calcium influx. Excision of I-IIa results in increased EPSC amplitudes as recorded with TEVC. By contrast, excision of I-IIb reduces EPSC amplitude by 50%, the latter being in accord with a reduction of channel expression in the active zones at the NMJ after I-IIb removal. Moreover, excision of I-IIb coincides with a loss of the ability to initiate compensatory presynaptic homeostatic compensation after acute blockage of post-synaptic glutamate receptors. This indicates that G $\beta\gamma$ -interaction with cacophony is important for normal synaptic function and for compensatory increases of release probability upon perturbation. Taken together, our results suggest that precise control of alternative splicing of mutually exclusive Cav2 exons is essential for fast synaptic transmission and homeostatic plasticity at the *Drosophila* NMJ.

Astrocytes regulate network activity in the developing somatosensory cortex of the glutamic acid decarboxylase 67 (GAD67)-GFP mouse

Timo Ueberbach¹, Clara Simacek¹, Sergei Kirischuk¹, Thomas Mittmann¹

¹Universitätsmedizin Mainz, Institut für Physiologie, Duesbergweg 6, 55128 Mainz, Germany

An imbalance in the ratio of the glutamatergic excitation vs. GABAergic inhibition (E/I-ratio) can affect the neuronal activity in cortical networks, thereby for example promoting hyperexcitability or even epileptogenesis. Such imbalance has been observed in models of brain injury and during development. In a balanced network activation of ionotropic and metabotropic GABA-receptors with its subsequent neuronal hyperpolarization plays an important role to stabilize the level of excitation.

Here we used a transgenic mouse line expressing the Green Fluorescent Protein (GFP) under the control of the glutamic acid decarboxylase 67 (GAD67) promotor (Tamamaki et al., 2003), which is known to cause impaired GABA synthesis. Our aim was to investigate the effects of this impaired GABA synthesis on the cortical network activity during development. We performed electrophysiological multi-electrode array recordings (MEA, Multichannel Systems) and whole-cell patch-clamp experiments in acute slices of the somatosensory cortex in vitro from GAD67-GFP mice and their wildtype littermates at two age groups of P14/15 and P21/22.

We observed a decreased spontaneous activity in the acute slices of the somatosensory cortex, as revealed by the number of spikes recorded from a 60 electrodes MEA chip, in GAD67-GFP mice at P14/15, but not at P21/22 tissue as compared to age-matched WT-littermate controls. Whole-cell patch clamp recordings from layers II/III pyramidal neurons revealed a decreased frequency and but not amplitude of mIPSCs in GAD67-GFP mice. To our surprise, the frequency of glutamate mediated mEPSCs was also reduced indicating a potentially compensatory downregulation of the glutamatergic transmission. Both effects lead to a temporarily increased E/I Ratio at P14/15, which is fully compensated at P21/22.

Furthermore, we disclosed that the decreased frequency of mEPSCs, but not mIPSCs, is mediated by tonic GABA-B-receptor activation. This tonic activation of GABA-B-receptors in GAD67-GFP mice is promoted by astrocytes, which regulate the extra synaptic GABA concentration through astrocytic GAT-3 transporters.

These data indicate that in this mouse model of an impaired GABAergic system the initial unbalanced E/I-ratio does not automatically lead to a hyperexcitable cortical network during development, but it rather triggers homeostatic synaptic processes to keep the E/I-ratio balanced.

This work was supported by a grant to TM (DFG, CRC 1080, C02).

Characterizing the role of the presynaptic protein CAPS in serotonin release from enterochromaffin cells

Sudeeksha Tyagi¹, Ahmed Shaaban¹, Sabine Beuermann^{2,3}, Frederike Maaß^{2,4}, Benjamin H. Cooper^{2,3}, Cordelia Imig¹

¹University of Copenhagen, Department of Neuroscience, Blegdamsvej 3B, 2200 København N, Denmark

²Department of Molecular Neurobiology, Max Planck Institute of Experimental Medicine, Göttingen, Germany;

³Present Affiliation: Department of Molecular Neurobiology, Max Planck Institute for Multidisciplinary Sciences, Göttingen, Germany;

⁴Present Affiliation: Department of NanoBiophotonics, Max Planck Institute for Multidisciplinary Sciences, Göttingen, Germany and Clinic of Neurology, University of Göttingen, Göttingen, Germany

Enterochromaffin (EC) cells are endocrine cells in the intestinal epithelium characterized by their secretion of serotonin. Enterochromaffin cells have sensory functions and can transduce physical and metabolic information obtained not only from nutrients, but also from noxious irritants or microbial factors in the gut lumen. Through an increasing number of studies, there has been a growing understanding of their sensory modalities, which are mediated by different receptors and intracellular signalling cascades. Nevertheless, many mechanistic aspects of 5-HT release from EC cells remain to be determined and the molecular underpinnings of vesicle exocytosis and release in these cells are yet to be described. To gain a better understanding of the serotonin release machinery in the gut, we investigated the two paralogs of the presynaptic protein Calcium-dependent activator protein for secretion (CAPS)- 1 and 2. CAPS proteins are important components of the presynaptic release machinery with an established role in vesicle secretion in various neurosecretory cell types. CAPS proteins have been demonstrated to mediate the fusion of both synaptic vesicles and large dense-core vesicles. To establish the expression of CAPS1 at the proteomic level in mouse and human enterochromaffin cells, we performed immunocytochemistry and biochemical assays. Adult mouse intestinal epithelial stem cells were used to generate CAPS knock-out organoids to study the functional role of the proteins. The characterisation of the CAPS deletion was achieved using single-cell carbon fibre amperometry to detect 5-HT release from individual fusing granules. We present here an experimental workflow to study, on the single-cell level, the role of individual molecular components of the presynaptic vesicle fusion machinery in the regulation of 5-HT secretion from EC cells in the gut.

Cooperative presynaptic functions of synaptotagmin 7 and Cav1 channels at the *Drosophila* neuromuscular junction

Jashar Arian¹, Selina Hilgert¹, Carsten Duch¹

¹Institut of Developmental Biology and Neurobiology, Research Team Prof. Dr. Carsten Duch, Hanns-Dieter-Hüsch-Weg 15, 55128 Mainz, Germany

Multiple vital aspects of presynaptic function are affected by calcium influx into the axon terminal, including synaptic vesicle (SV) release, recycling, replenishment of the readily releasable pool (RRP) of SVs, and synaptic plasticity. For the proper coordination of these processes presynaptic calcium signals must be read out by calcium sensing proteins, such as the family of synaptotagmin proteins. While the fast and low affinity synaptotagmin 1 is well known to ensure synchronous SV release, in mammalian synapses the slower but higher affinity synaptotagmin 7 (Syt7) is thought to be involved in asynchronous release, synaptic facilitation, and RRP replenishment, but many questions on the precise function of Syt7 remain open (Huson, Regehr, *Curr Opin Neurobiol*, 2020). Moreover, a recent study at the *Drosophila* larval neuromuscular junction has suggested that many of the Syt7 functions proposed for mammalian synapses are not conserved in flies (Guan et al., *eLife*, 2020). Here we propose a model in which Syt7 acts in concert with calcium influx through the voltage gated calcium channel Dmca1D (Cav1 homolog) to regulate SV replenishment, asynchronous release, and short-term facilitation in *Drosophila melanogaster*.

We found that Syt7 localizes outside presynaptic active zones and is required for the fast phase of recovery of RRP replenishment after synaptic depression as induced by high frequency stimulation. Moreover, this function of Syt7 is inhibited by calcium influx through Cav1 channels. Given that calcium through Cav1 also augments SV recycling (Krick et al., *PNAS*, 2021), we propose that both mechanisms cooperate to maintain synaptic function during periods of high synaptic activity. Cav1 channel activation promotes faster SV recycling rates and decreases RRP replenishment, so that synapse function at lower transmission amplitudes can be maintained at high rates for prolonged times. Furthermore, short-term facilitation as observed upon Cav1 channel knock down (Krick et al, *PNAS*, 2021) is abolished upon concomitant Syt7 knockout. These findings suggest an interplay of Syt7 and presynaptic Cav1 in the orchestration of short-term plasticity, SV recycling, and RRP replenishment that cooperatively tunes these presynaptic mechanisms to behaviorally relevant activity patterns.

Determining the number and organization of active zone proteins at the rod ribbon synapse with 3D-MINFLUX

Chad Grabner, Isabella Jansen⁴, Christian Wurm⁴, Tobias Moser^{1,2,3,5}

¹ Institute for Auditory Neuroscience, University Medical Center Göttingen, 37075 Göttingen, Germany

² Auditory Neuroscience and Synaptic Nanophysiology Group, Max Planck Institute for Multidisciplinary Sciences, Göttingen, Germany

³ Collaborative Research Center 1286, University of Göttingen, Göttingen, Germany

⁴ Abberior Instruments, Hans-Adolf-Krebs-Weg 1, 37077 Göttingen, Germany

⁵ Cluster of Excellence "Multiscale Bioimaging: from molecular machines to networks of excitable cells", University of Göttingen, 37075 Göttingen, Germany

Background. Presynaptic active zones (AZ) are designed to trigger synaptic vesicle (SV) fusion with a temporal and spatial precision that elevates synaptic glutamate concentrations to levels sufficient to activate postsynaptic targets. Sensory neurons in the eye and ear are characterized by a large presynaptic, cytosolic AZ structure called the synaptic ribbon, which is built in part from a unique protein called Ribeye that is expressed exclusively in hair cells (HCs), photoreceptors (PRs), and retinal bipolar cells (BCs). It is generally believed that the ribbon performs two important functions. First, it is proposed to regulate the traffic of SVs, either passively or actively, to the base of the ribbon where a host of conventional AZ proteins are assembled into SV release sites, and second it is hypothesized to provide a scaffolding that organizes AZs into linear arrays of release sites. In recent years, results from studies on ribbonless cochlear inner HCs (Jean et al, 2018; Becker et al., 2018), rod PRs (Grabner and Moser, 2021) and rod BCs (Maxeiner et al, 2016) have found a stronger functional phenotype in the retina than in the inner ear, and in particular the presynaptic AZ of rod PRs exhibit significant structural alterations that should contribute to the observed loss of function. For instance, ribbonless rods show a 60 % decrease in SV density and reduction in the overall territory of the AZ (Maxeiner et al, 2016; Dembla et al., 2020), which correlates with the observation that exocytosis measured from ribbonless rods was reduced by 80 % (Grabner and Moser, 2021). These findings support the idea that the rod ribbon promotes the assembly of a large number of SV release sites, and recently, using 3D-MINFLUX imaging, we showed that AZ proteins are positioned in two parallel rows on either side of the rod ribbon, and for the length of the ribbon (Grabner et al., 2022). Interestingly, Cav channels and SV priming protein ubiquitous-Munc13-2 are positioned close to one another at the plasma membrane where SVs at the base of the ribbon are presumed to dock for fusion, while epitopes on scaffolding proteins bassoon and RIM2 where positioned more medial at the base of the ribbon. In ongoing work, we are comparing different antibody labeling schemes to more precisely localize individual proteins using 3D-MINFLUX. Moreover, we are also testing new procedures for simultaneous (multicolor) and sequential (dna-paint) imaging of different AZ proteins, which will allow us to illustrate the relative 3D spatial orientations of different AZ proteins about the ribbon AZ. Together, this structural work will allow us to better understand how the AZ is assembled at the level of individual release sites, with single molecule precision.

Developmental Changes in Function of Vasoactive Intestinal Peptide (Vip)- positive GABAergic Interneurons of the Somatosensory Cortex in Mice

Clara Anna Simacek¹, Thomas Mittmann¹

¹Institute for Physiology, University Medical Center of the Johannes Gutenberg University, 55128 Mainz, Germany

Inhibitory interneurons (INs) fundamentally shape neuronal activity in cortical networks by releasing gamma-aminobutyric acid (GABA). GABAergic INs highly impact the developing brain, and dysfunctions can lead to neurodevelopmental disorders that underlie psychiatric conditions like schizophrenia or autism (Allene et al., 2008 and Rossignol 2011). A subclass of GABAergic interneurons coexpressing vasoactive intestinal peptide (Vip) play a key role in developing cortical circuits and their dysregulation leads to impairments in sensory processing and learning as well as other behaviors (Batista-Brito et al., 2017).

So far, a profound cell-type specific functional characterization of Vip-INs across different postnatal stages is lacking. For this, we performed investigations in transgenic mice, expressing the fluorescent protein tdTomato in Vip-INs, which is mediated by the loxP- cre system. Experiments were conducted at three different postnatal stages: P8 – P10 (neonatal), P14 – P16 (juvenile) and P34 – P36 (adult). In each age group we performed whole-cell patch clamp recordings to examine the passive and active membrane properties of Vip-INs in L2/3 of the somatosensory cortex.

The analysis revealed that the majority of passive and active membrane properties mature between the second and third postnatal week. Regarding passive membrane properties, the resting membrane potential, membrane resistance as well as the firing threshold show a significant decrease between the neonatal and juvenile age group. In the same time window, action potentials of Vip-INs increase in their amplitudes and in their rising slope while they decrease in their halfwidth. This suggests that Vip-INs exhibit a facilitated action potential generation from the third postnatal week on.

Our data gives new insights in the so far relatively poorly investigated class of Vip-INs in the developing neocortex. It would be interesting to link these results to excitatory and inhibitory synaptic inputs that are received by Vip-INs at the three different age groups. In this way, we can examine putative changes of the subunit composition of ion channels and neurotransmitter receptors. We hereby contribute to a better understanding of the highly heterogeneous world of GABAergic interneurons, which strongly impact brain functions from embryonic to adult stages.

This work is supported by a grant to TM (DFG, CRC 1080, C02)

Differential contribution of mEC and dCA1 to spatial and velocity coding of subicular pyramidal neurons

Hiroshi Kaneko¹, Dennis Dalügge¹, Stefan Remy^{1,2,3}

¹Leibniz Institute for Neurobiology (LIN), Department Cellular Neuroscience, Magdeburg, Germany

²German Center for Neurodegenerative Diseases (DZNE), Magdeburg, Germany

³Center for Behavioral Brain Sciences (CBBS), Magdeburg, Germany

The subiculum is the major output structure of the hippocampal formation and plays an important role in learning and memory and spatial navigation. Subicular pyramidal neurons receive excitatory synaptic input from entorhinal cortex and CA1.

It is not known, how this layered input from mEC and CA1 is integrated by individual neurons and converted into spatially tuned output.

To address this question, first, we recorded excitatory postsynaptic currents (EPSCs) in subicular neurons in freely moving mice using the whole cell patch clamp configuration during spatial navigation. Second, in order to investigate how CA1 and mEC inputs influence the spatial tuning of subicular neurons, we performed Chronos-assisted circuit mapping (CRACM) with patch clamp recordings in acute hippocampal slices and 2-photon calcium imaging in subiculum by silencing axon fibers from either CA1 or mEC with DREADDs while mice were running on a linear track.

In whole-cell voltage clamp recordings combined with behavioral observation, we observed speed- and place-tuning of cumulative synaptic input (EPSCs). However, considerable fraction of neurons showed no spatial and behavioral tuning in the somatic voltage-clamp recordings. Our CRACM data showed that mEC input is integrated more distally than CA1 input, which is integrated in the perisomatic region. Inactivation of CA1 input resulted in a degradation of both place and velocity tuning. In contrast, inactivation of mEC input exclusively reduced place tuning. Taken together, we provide experimental evidence for differential contribution of mEC and CA1 input to spatially tuned output of subicular pyramidal neurons.

Disease-related variations in the UNC13A gene cause presynaptic dysfunction

Siqi Sun¹, Aisha Ahmad¹, Mareike Lohse¹, Jonas D. Sommer¹, Judith J. Jans², Mišo Mitkovski³, Holger Taschenberger³, Nils Brose³, Anita Rauch⁴, Reza Asadollahi⁴, Jeremy S. Dittman⁵, Noa Lipstein^{1,3}

¹Leibniz-Forschungsinstitut für Molekulare Pharmakologie, Department of Molecular Physiology and Cell Biology, Berlin, Germany.

²Department of Genetics, University Medical Center Utrecht, Utrecht, Netherlands.

³Department of Molecular Neurobiology, Max Planck Institute of Experimental Medicine, Goettingen, Germany.

⁴Institute of Medical Genetics, University of Zurich, Schlieren, Switzerland.

⁵Department of Biochemistry, Weill Cornell Medicine, New York, NY, United States.

Intact communication between neurons occurs at synapses and is absolutely essential for information processing in neuronal networks. A massive body of work draws a link between genetic variations in synaptic proteins and complex brain disorders, but the mechanisms by which synaptic transmission is altered to product disease are not well-understood. At the presynaptic compartment, hundreds of proteins act together to determine the strength, timing, and plasticity of neurotransmitter release, thus shaping the properties of synaptic transmission. Of those, Munc13 proteins are key regulators of neurotransmitter release, as they mediate the priming step that renders synaptic vesicles fusion-competent. Here, we describe a novel congenital brain disorder of the synaptic vesicle priming step, characterized by autism-spectrum disorder, a dyskinetic movement disorder, and intellectual disability. We identified an array of disease-related variations in all Munc13-1 protein domains, and carried an electrophysiological characterization that identified both loss- and gain of function mechanisms leading to synaptic transmission dysfunction. Our study underscores the critical importance of fine-tuned presynaptic control in normal brain function, and adds the neuronal Munc13 proteins and the synaptic vesicle priming process to the known etiological mechanisms of psychiatric and neurological disease.

Dynamic interplay between Cav2 channels and the presynaptic cytomatrix in mechanisms of neurotransmission

Michela Borghi¹, Stephan Weissbach¹, Anna Fejtova², Martin Heine¹

¹Johannes Gutenberg University Mainz, Institute for Developmental Biology and Neurobiology, Mainz, Germany

²Department of Psychiatry and Psychotherapy, University Hospital Erlangen, Friedrich-Alexander Universität Erlangen-Nürnberg, Erlangen, Germany

In the presynaptic active zone (AZ), voltage-gated calcium channels' (VGCC) proximity to docked SV is fundamental for fast neurotransmitter release. Scaffold proteins RIM, RBP, ELKS and Bassoon were shown to mediate tethering of Cav2.1 and Cav2.2 channels close to synaptic vesicles (~20 nm). Indeed, scaffolding proteins present peculiar binding domains that can be specific for individual channel subtypes. Interestingly, deletion of these binding domains results in decreased channel abundance and impaired vesicle release. However, the mechanisms by which individual VGCC subtypes enter and/or escape AZs are still elusive. Particularly, VGCC synaptic localization could be mediated by direct interaction with scaffolding proteins or through a general trapping in a phase-separated compartment. Here, we deliver cell-penetrating peptides that mimic known binding sites between VGCC and scaffold proteins to cultured hippocampal neurons, acutely disturbing the affinity landscape of VGCC/scaffold interactions. In parallel, we use computational analyses and HEK293T cells-based assays to predict unknown phase-separation properties of selected scaffolding proteins. Our functional glutamate imaging results indicated time-dependent alterations in synaptic transmission following incubation with interfering peptides, that translated in local rearrangement of VGCC observed through single-particle tracking. Additionally, single molecule tracking and confocal imaging of VGCC confirmed their differential distribution in AZs following acute interference with scaffold interactions. Thus, the ability of the presynapse to quickly rearrange its channel composition lays the foundation for further investigations on how this property is exploited in terms of synaptic remodeling following plasticity events.

Effects of activin A and enriched environment on GABAergic inhibition in dorsal vs. ventral hippocampus

Maria Jesus Valero Aracama¹, Fang Zheng¹, Christian Alzheimer¹

¹Friedrich-Alexander-Universität Erlangen-Nürnberg, Institute of Physiology and Pathophysiology, Universitätsstraße 17, 91054 Erlangen, Germany

Activin A, a member of the transforming growth factor-beta; family, is a homodimeric protein with multiple regulatory effects throughout the body. In the CNS, activin A has been long recognized as a neurotrophic and neuroprotective factor during development and after brain injury, respectively. More recent evidence implicates activin A also in the regulation of the strength of excitation and inhibition in behaviorally relevant neuronal circuits of the healthy and diseased brain. For example, it has been shown that GABAergic inhibition of the dorsal hippocampus, a region functionally important for learning and memory, is modulated by activin signaling. Since the hippocampus is known to be functionally and neurophysiologically segregated along its dorso-ventral axis, we investigated here, if the GABAergic system of ventral hippocampal regions, which are predominantly involved in affective behavior, differs from that of dorsal regions, and if activin tunes GABAergic inhibition in a region-specific fashion.

To address these issues, we performed whole-cell voltage-clamp recordings from CA1 pyramidal cells in hippocampal mouse slices. We found that compared to their dorsal counterparts, ventral CA1 pyramidal cells display a more dynamic and effective response to evoked inhibitory impulses. Consistent with our finding that the level of activin A protein is higher in dorsal than in ventral hippocampus, disruption of activin receptor signaling (using slices from transgenic mice expressing a dominant-negative mutant of activin receptor IB, dnActRIB), produced an increase in inhibitory transmission only in dorsal CA1 neurons. We next asked how a rise in endogenous activin A would affect GABAergic inhibition along the longitudinal axis of the hippocampus. For this purpose, we performed *ex vivo* recordings from wild type and dnActRIB mice after overnight exposure to an enriched environment (EE), a behavioral experience that we have previously shown to engender a robust increase in activin A levels in both dorsal and ventral hippocampus. Compared to control mice from standard cages, the behaviorally induced surge in activin A produced a decline in ventral inhibition, an effect that was absent in slices from dnActRIB mice. Underscoring the essential role of activin in the EE-associated modulation of ventral inhibition, this effect was mimicked by acute application of recombinant activin A in control slices. In summary, both genetic and behavioral manipulations of activin receptor signaling affected the given dorso-ventral difference in synaptic inhibition, suggesting that activin A is a key player in tuning the strength of GABAergic inputs along the longitudinal axis of the hippocampus.

Effects of activin on intrinsic excitability and synaptic plasticity of CA1 pyramidal cells differ between dorsal and ventral hippocampus

Marc Dahlmanns¹, Maria Jesus Valero-Aracama¹, Fang Zheng¹, Christian Alzheimer¹

¹Friedrich-Alexander-Universität Erlangen-Nürnberg, Institute for Physiology and Pathophysiology, Universitätsstraße 17, 91054 Erlangen, Germany

It becomes increasingly recognized that the hippocampus displays considerable structural and functional diversity along its dorsoventral axis. Thus, findings from dorsal hippocampus (DH), which has been mostly studied in the past, do not necessarily apply to ventral hippocampus (VH). Extending previous work obtained from DH, we report here a dorsoventral gradient in the level of activin A protein and demonstrate how this gradient differentially affects the neurophysiological effects of this factor in DH vs. VH. Activin A is a member of the transforming growth factor β (TGF- β) family, which we have previously identified as a regulator of intrinsic firing and synaptic transmission in dorsal CA1.

We performed whole-cell recordings from visually identified CA1 pyramidal cells and field potential recordings in CA1 stratum radiatum, using dorsal and ventral hippocampal slices from wild type (wt) mice and from transgenic mice expressing a dominant-negative mutant of activin receptor IB (dnActRIB), which disrupts activin receptor signaling in a forebrain-specific fashion.

We found that the level of activin A protein is substantially higher in DH than in VH, in both wt and mutant preparations. Consistent with the pronounced dorsoventral gradient of activin A, disruption of its downstream signaling enhanced intrinsic excitability only in dorsal CA1 pyramidal cells, whereas their ventral counterparts remained unaffected. In field potential recordings, synaptic responses to single pulse stimulation of Schaffer collaterals in dnActRIB hippocampi displayed a dorsal>ventral increase in facilitation, each compared to wt responses. Unlike LTP, LTD and depotentiation in DH, their VH equivalents were not altered in the mutant preparation.

In summary, our study suggests that owing to its preferential impact on DH properties, activin signaling contributes to the neurophysiological segregation of the hippocampus along its longitudinal axis.

Exploration of Mechanisms Governing Formation of Postsynaptic Density Using the PyRID Simulator

Nahid Safari¹, Christian Tetzlaff¹

¹University Medicine Göttingen, Center for Biostructural Imaging of Neurodegeneration (BIN), Von-Siebold-Straße 3a, 37075 Göttingen, Germany

The postsynaptic density (PSD) is found beneath the membrane of the postsynaptic spine and forms a membraneless, protein-rich cellular compartment. The internal organization of the postsynaptic density is identified by postsynaptic scaffolding molecules, adhesion molecules, receptors, and actin cytoskeleton components. This organization is crucial in receiving, interpreting, and storage of transmitted signals. The PSD is an incredibly dynamic structure with continuous component exchanges and repositioning. How the PSD remains functionally stable to reliably implement synaptic transmission and plasticity, despite the underlying dynamic molecular substrate, remains unknown. Liquid-liquid phase separation (LLPS) has been postulated in recent studies as a mechanism to account for how PSDs are formed [1,2]. A fairly recent study, however, suggests that the LLPS mechanism may only partially, not entirely, control the positioning of the PSD components as they appear to be organized in a quasi-regular lattice [3].

To unravel the mechanism regulating PSD organization, we conducted two steps: i) we developed a new simulation framework named PyRID and ii) we developed a minimal coarse-grained patchy model of the PSD, comprising interacting multivalent PSD95 and Shank proteins.

PyRID is a particle-based reaction diffusion simulation tool based on the well-known simulators ReaDDy, MCell, and Sarkas. Comparing PyRID to previous cell biological process simulators reveals clear advantages: PyRID includes several essential functions in addition to simulating particle-reaction interactions. It can support triangulated mesh geometries, which enables us to study narrow escape qualities and the impact of membrane shapes on molecular dynamics. Additionally, PyRID offers molecular rigid bead models. Precise descriptions of the diffusive motion of molecules can be produced using experimentally or theoretically calculated diffusion tensors. Last but not least, anyone with skills in Python programming can modify and extend PyRID with relative ease.

Using PyRID, we developed coarse-grained models of PSD95 and Shank, which are the two most abundant scaffold proteins at the PSD. Coarse-grained models simplify the atomic structure of a molecule without significantly altering its biophysical- and -chemical properties [4]. This enabled us to investigate the phase behavior of the PSD as a whole and, in parallel, the positioning of each molecule of interest. Furthermore, our model enables us to investigate how neuroligin1, which is a synaptic cell-adhesion molecule that is an essential part of the postsynaptic complex enhancing the synaptic localization of PSD95 proteins, may influence how postsynaptic assemblies are organized. In addition, we can explore the role of the actin cytoskeleton in PSD organization, because the scaffolding complexes anchor the membrane to the cytoskeleton through the interaction of Shank proteins with actin. We systematically look into how various parameters affect the system dynamics. We vary these parameters and assess their effect on experimentally observable nanocluster characteristics and their spatiotemporal dynamics [5,6].

To the best of our knowledge, the resulting model of self-organizing PSD components is the first model to study the PSD organization on a single molecule basis.

Gut-to-brain signaling - enterochromaffin cell communication with vagal sensory neurons

Esmira Mamedova¹, Ahmed Shaaban¹, Cordelia Imig¹

¹University of Copenhagen, Department of Neuroscience, Blegdamsvej 3B, 2200 Copenhagen, Denmark

Gut-to-brain signaling is an essential process in the human body that controls metabolic homeostasis. In particular, vagal sensory nodose ganglion (NG) neurons express multiple types of mechano-, volume- and chemosensory- receptors, and their activation is involved in the regulation of gut motility, digestion, and satiety signaling. Vagal sensory afferents additionally receive inputs from different enteroendocrine cells (EEC) of the gut epithelium that respond to changes in the gut lumen by releasing classical neurotransmitters and peptide hormones. Enterochromaffin (EC) cells represent more than 50% of the total EEC cells and are the major producer of peripheral serotonin. It has been demonstrated that EC cells are electrically excitable, express components of the neuronal neurotransmitter release machinery, and come into close proximity to vagal afferents, raising the intriguing hypothesis that EC cells form functional synaptic contacts with nodose neurons [1]. To investigate how signaling occurs between EC cells and vagal NG neurons, we established a co-culture system of gut epithelial monolayers including EECs and isolated NG neurons. To visualize and characterize potential synaptic contact points between serotonergic EC cells and nodose ganglion neurons expressing ionotropic 5-HT₃ receptors, we used transgenic mouse lines expressing cyan fluorescent protein (CFP) under the control of the tryptophan hydroxylase promoter 1 (Tph1-CFP) and GFP under the control of the 5-HT₃ receptor (5HT₃R-GFP), respectively. By recapitulating the gut-brain axis in vitro, we anticipate that it will become possible to dissect the fundamental cell biological and molecular mechanisms that determine fast, synapse-like signaling between EC cells and nodose neurons. Ultimately, expanding our knowledge of gut-brain communication will allow us to develop new treatments for targeting gut-related diseases.

1. Bellono, N.W., et al., Enterochromaffin Cells Are Gut Chemosensors that Couple to Sensory Neural Pathways. *Cell*, 2017. 170(1): p. 185-198 e16.

HCN-channel mediated functional changes in Parvalbumin-positive interneurons in the somatosensory cortex of mice following traumatic brain injury

Qiang Wang¹, Thomas Mittmann¹

¹Institute of Physiology, University Medical Center of the Johannes Gutenberg University, Mainz, Germany

Traumatic Brain Injury (TBI) is known to impair motor coordination and affect cognitive functions chronically leading to neurodegenerative disorders and/or epileptogenesis. Parvalbumin-positive (PV) interneurons are one subpopulation of GABAergic interneurons, which can balance the excitatory output of connected pyramidal neurons and thereby significantly influence cortical network excitability. Here we investigated traumatic brain injury (TBI) induced functional changes of surviving PV-interneurons in the ipsilateral hemisphere of the somatosensory cortex in mice.

We induced our established TBI model (Ihbe et al. 2022) and applied a controlled cortical impact in the motor and partially somatosensory cortex of PV-cre x tdTomato mice at the age of 21 days. After survival times of 24 – 48 h we performed immunohistochemistry and electrophysiological recordings on cortical brain slice tissue containing the ipsilateral hemisphere. Sham-operated littermates served as controls. Using antibodies against Parvalbumin and NeuN we observed a 40% loss in the total number of PV interneurons in the vicinity of the injury 24 – 48 h after TBI. Interestingly, we could not detect morphological changes in the surviving and biocytin filled PV-interneurons as investigated by Sholl analysis. Next, we investigated functional properties of hyperpolarization-activated cyclic nucleotide-gated cation (HCN) channels at PV-interneurons early after TBI. Here, the ZD7288 sensitive, HCN-channel mediated sag voltage component as well as HCN-channel mediated currents (-109.28 ± 60.43 pA, $n=16$) were significantly increased ($p<0.005$) after TBI as compared to sham-operated controls (-34.67 ± 29.24 pA, $n=13$). We observed no changes in the activation and deactivation curves of HCN-channel mediated currents after TBI, which indicates an unaltered subunit composition of HCN-channels at PV-interneurons early after TBI. Interestingly, the focal brain injury led to a significantly reduced ($p<0.005$) maximal firing frequency of evoked action potentials in PV-interneurons. These data suggest that the observed alterations in the functional properties of HCN-channels at PV-interneurons can contribute to our previously reported imbalance of glutamatergic excitation vs. GABAergic inhibition in the cortical network early after TBI.

This work was supported by the German Research Foundation to TM (DFG, CRC1080, C02)

Investigating nanoscale molecular organisation at cerebellar synapses with superresolution microscopy

Maureen McFadden¹, Gael Moneron², David DiGregorio³, David DiGregorio³

¹Unit of Synapse and Circuit Dynamics, CNRS UMR 3571, Institut Pasteur, Paris, France¹

Cerebellar mossy fibers are one of the major input types to the cerebellar cortex (CC) and provide multi-modal information to be integrated by the CC to fine-tune behaviour. Although mossy fibers are often considered as a single synapse type, functional synaptic diversity between different mossy fibers has been well characterized and found to be computationally relevant for circuit function. However, the molecular underpinnings of this functional diversity remain unknown.

We previously showed that nanoscale molecular organisation at presynaptic terminals dictates synaptic strength and dynamics at different synapse types. Notably, the nanoscale organisation of voltage-gated calcium channels (VGCCs) and synaptic vesicle (SV) release sites has been shown to differ between facilitating, low release probability (pr) synapses and depressing, high pr synapses, like the excitatory parallel fiber (PF) to Purkinje cell synapse and inhibitory molecular layer interneuron (MLI) to MLI synapse, respectively. We hypothesize that differences in molecular organisation could also potentially explain the differences in release probability and short-term plasticity observed between different mossy fibers. We then set out to use stimulation emission depletion microscopy (STED) to examine whether the functional diversity correlates with macromolecular topography differences. Superresolution microscopy techniques such as STED provide an advantage over electron microscopy in throughput, allowing for the imaging of hundreds of synapses within a single field of view at subsynaptic resolution.

We first investigated whether it is possible to use STED superresolution microscopy to differentiate nanoscopic topographies of calcium channels and synaptic vesicles, by examining spatial signatures at excitatory and inhibitory synapses in the molecular layer, where we know the molecular topographies. Indeed, we found qualitative differences in the staining of SV release sites and Cav2.1 subunits between PF and MLI terminals, seemingly confirming what has been previously observed with EM, and are currently quantifying these differences. In order to control for synapse orientation in the observed differences in protein distribution, we are also optimising a workflow to identify and image in high resolution, both in 2D and 3D, synapses that are oriented parallel to the imaging plane in a synaptically dense brain region. This method will then be used to assess the topology of VGCCs and SV release sites at mossy fiber synapses, where the topology is unknown. Comparing these topologies at different mossy fiber input types will provide some insights as to the role of SV release site and VGCC distribution in the diversity in synaptic dynamics observed between distinct mossy fibers.

Investigating presynaptic nanoarchitecture using proximity labeling approaches

Mareike Lohse^{1,2}, Siqi Sun², Sofia Elizarova², Olaf Jahn¹, Nils Brose¹, Noa Lipstein²

¹ Max Planck Institute for Multidisciplinary Sciences, Dept. Molecular Neurobiologie, Göttingen, Germany.

² Leibniz-Forschungsinstitut fuer Molekulare Pharmakologie, Dept. of Molecular Physiology and Cell Biology, Berlin, Germany.

Synaptic transmission, the process of information transfer between neurons, occurs at synapses and is controlled by the coordinated activity of different protein complexes. Unraveling the mechanisms of synaptic transmission and the functional differences between synapse subtypes, therefore, requires knowledge of protein composition and organization. I use proximity labeling, an unbiased, mass-spectrometric-based approach, to elucidate the proteomic composition and organization of molecular complexes at presynaptic subcompartments. Our protocol produces highly specific readouts of presynaptic cytosolic and membranous compartments. I propose that monitoring the molecular composition and organization of the presynapse will help in understanding synaptic transmission mechanisms and how synaptic function and dysfunction are defined.

Mapping the orientation of synaptic proteins in mammalian synapses and *Drosophila* NMJs by two-photon polarization microscopy

Maksim Galkov¹, Komal Patil², Gaia Tavosanis², Martin Fuhrmann³, Dirk Dietrich⁴,
Susanne Schoch¹

¹University Hospital Bonn, Department of Neuropathology, Venusberg-Campus 1, 53127 Bonn, Germany

²German Center for Neurodegenerative Diseases (DZNE), Dynamics of Neuronal Circuits, Venusberg-Campus 1, 53127 Bonn, Germany

³German Center for Neurodegenerative Diseases (DZNE), Neuroimmunology and Imaging Group, Venusberg-Campus 1, 53127 Bonn, Germany

⁴University Hospital Bonn, Department of Neurosurgery, Venusberg-Campus 1, 53127 Bonn, Germany

The synaptic conversion of an electrical to a chemical signal is mediated by the multi-component pre- and postsynaptic cytomatrix. In recent years, the composition of these cytomatrixes has been resolved and progress has been made in resolving the ultrastructural organization on both sides of the synapse. However, we still lack a detailed understanding of the 3-D organization of individual cytomatrix components. In this study we aimed to investigate synapse geometry using the effect of linear dichroism (LD) and two-photon polarization microscopy. To this end, we calculated the proportion of uniformly oriented molecules (LD-fraction) and compared it with the theoretical fraction generated by image noise to estimate the reliability of the registered LD. The angle of laser beam polarization providing maximal fluorophore emission (β angle) was also analyzed.

We validated our approach by demonstrating high LD in methoxy-X04 stained amyloid plaques and in a membrane-bound eGFP variant expressed in HEK293T cells and primary neurons. We next inserted the membrane-bound eGFP in neurexin1 α to target the construct to synapses and showed that the reliable LD-fraction can be registered in the presynaptic membrane as well. Moreover, we fused the actin filament reporter LifeAct to eGFP via several linkers and found that non-structured linkers provide LD: regular and robust β angle values in filopodia of HeLa cells were observed.

Then LD was measured in synapses of cultured mouse primary neurons and *Drosophila* larval NMJs expressing key active zone proteins fused with eGFP via non-structured linkers. We did not observe LD of active zone proteins indicating that their regular spatial orientation in synapses can be excluded. However, certain linear regularities of their arrangements with radial symmetry would remain undetected. Our data form the basis for further analyses aiming at resolving the spatial orientation of components of the presynaptic cytomatrix at the active zone.

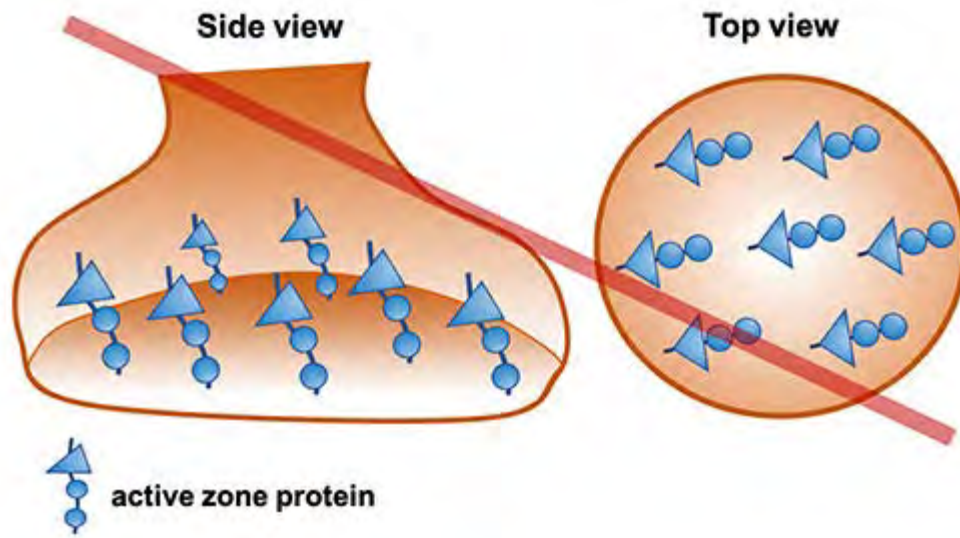

Regular spatial organization of protein molecules in a synapse that can be excluded since no LD was found.

Maturation of activity-dependent endocytosis during terminal differentiation of cochlear inner hair cells

Guobin Huang¹, Stefan Münkner¹, Jutta Engel¹, Stephanie Eckrich¹

¹Saarland University, Department of Biophysics and Center for Integrative Physiology and Molecular Medicine (CIPMM), D-66421 Homburg/Saar, Germany

Cochlear inner hair cells, the primary sensory cells of the auditory system, reliably transmit sound to the auditory pathway via the indefatigable release of synaptic vesicles. Equally efficient retrieval of the vesicle membrane and active zone clearance via endocytosis and associated efficient replenishment of the synaptic vesicle pool are decisive factors for stable sound encoding.

Prior to the onset of hearing IHCs and their synaptic release machinery undergo terminal differentiation. So far it is unknown whether endocytosis experiences a comparable maturation process. Using quantitative fluorescence in situ hybridization complemented by immunohistochemical protein labeling, we recently showed a developmental up-regulation of several endocytic proteins including dynamin-1 suggesting that activity-dependent endocytosis undergoes terminal differentiation in IHCs (Huang & Eckrich (2021) *Front Cell Neurosci*; 15:643517).

Here, we assessed activity-dependent endocytosis of IHCs via electrophysiological patch clamp recordings of membrane capacitance (C_m) changes (ΔC_m) as a measure of exo- and endocytosis during terminal differentiation and after the onset of hearing at ambient or near-physiological temperature. The capacity to replenish the synaptic vesicle pool was tested by challenging the IHCs with long-term repetitive stimulation. The function of dynamin-1 was assessed at both ages using the highly potent dynamin inhibitor dyngo-4a. For IHCs of both age groups, we found that depolarization-induced exocytosis was increased at higher temperatures. Thereafter, a linear decline of C_m representing endocytosis was observed at ambient temperature, whereas an additional fast declining endocytosis component appeared near physiological temperature. The depolarization-induced increase and subsequent decline of C_m were more pronounced in mature than in pre-mature IHCs. In both age groups, ΔC_m reached a steady-state at higher temperature following repetitive intense stimulation reflecting a balance between exo- and endocytosis. In mature IHCs, this state was reached faster indicating more efficient endocytic mechanisms than in pre-mature IHCs. When blocking dynamin function, we found evidence of slowed endocytosis in pre-mature IHCs, which were no longer able to counterbalance exocytosis upon long-term stimulation. In contrast, mature IHCs were much less affected by dyngo-4a.

Together our data indicate increased endocytosis efficiency in mature than in pre-mature IHCs. The higher sensitivity of pre-mature IHCs to dyngo-4a despite the lower abundance of dynamin-1 indicates that additional dynamin-independent endocytic mechanisms might ensure maintenance of efficient endocytosis in functionally mature IHCs that are not yet present during terminal differentiation.

Funded by DFG-project EC488/1-1 (to S.E.), and Saarland University.

Molecular mechanisms of synaptic vesicle release in Dorsal Root Ganglion neurons

Lucia Rojas¹, Chungku Lee¹, JeonSeop Rhee¹

¹Max-Planck-Institut for Multidisciplinary Sciences, Department of Molecular Neurobiology, Synaptic Physiology Group, Hermann-Rein-Strasse 3, 37075 Goettingen, Germany

Action Potential – triggered neurotransmitter release depends on Ca²⁺ dependent molecular pathways that converge on and control the availability, fusogenicity and recycling of Synaptic vesicles. As such, the proteins involved in those pathways have been a central focal point of molecular neuroscience. Their study in CNS synapses has not been matched with an equally careful characterization of synapses in the peripheral nervous system. Therefore, the sequence of events and the key molecular players that regulate PNS neurotransmitter release and SV exocytosis are still, largely not understood.

Dorsal root ganglion (DRG) neurons are primary sensory receptors from the PNS. From the soma a single process called the stem axon bifurcates into a peripheral and a central axon. Sensory information is transduced and transmitted by the peripheral axon to the central one reaching the central terminals which synapse with dorsal horn spinal cord neurons. Accurate interpretation of a particular sensory stimulus relies on timely synaptic transmission between DRGs and their postsynaptic partners. In this way, the timing, intensity and class of the stimulus perceived are encoded in micro circuits residing at the dorsal horn of the spinal cord, ensuring that sensory input is correctly processed and integrated throughout the ascending sensory tracts and respective nuclei.

To provide mechanistic insights into the molecular mechanism of synaptic release in DRG neurons, we assessed their electrophysiological properties. Using co-cultures and dual patch whole-cell recordings, DRG neurons were stimulated and eEPSCs were recorded from 1: hippocampal neurons and 2: spinal cord neurons. Initially, we assessed the synaptic release using Munc13-1 and -2 double knock out (Munc13 DKO) DRG neurons to find out how Munc13s affect glutamate release.

Many studies postulate that Munc13 is a master-regulator of docking, priming, RRP maintenance and synaptic function at large. Surprisingly, however, in this study, DRG neurons still show eEPSC in the absence of Munc13-1 and -2, albeit with slower release kinetics. The observed relative contributions of DRG neuron subtypes to the heterogeneous pool of STP pattern was altered in the DKO. Namely, depressing synapses were less frequently observed. In addition, eEPSC amplitudes were decreased by about 30% when DRG were cocultured with hippocampal neurons and by 80% when cocultured with spinal cord neurons, suggesting the presynaptic neurotransmitter release could be modulated in a target-dependent manner.

It's been suggested that DRG neurons can release synaptic vesicles in a calcium-independent manner. To test this hypothesis, we exposed DRG – spinal cord co cultures to different calcium concentrations and found that DRG neurons have higher calcium sensitivity. Taken together, these results suggest that in primary afferent sensory neurons, neurotransmitter release relies on a different molecular landscape in order to comply with the physiological needs specific to the somatosensory system. These results also allow us to bridge and understand synaptic transmission and heterogeneity in the context of DRG fiber diversity and probe molecular mechanisms underlying neuropathic pain.

Molecular subgroups of mouse cortical VIP neurons – laminar distribution, firing pattern and optical stimulation

Mirko Witte¹, Flore Schork¹, Felicita Fischer¹, Philipp Kolligs¹, Jenifer Rachel¹, Felix Preuss¹, Sandra Heinzl¹, Martin Möck¹, Jochen Staiger¹

¹University Medical Center Göttingen, Institute of Neuroanatomy, Kreuzberggring 36, 37075 Göttingen, Germany

Vasoactive intestinal polypeptide (VIP)-expressing neurons belong to the class of GABAergic interneurons in the mouse neocortex and are predominantly located in layer II/III. VIP neurons are integrated in different neuronal networks and were previously considered to be predominantly inhibitors of other GABAergic interneurons (called as disinhibitors). Recent studies demonstrate that they can also directly inhibit excitatory principal neurons. Molecular analyses have further differentiated VIP interneurons based on their co-expression of cholecystinin (CCK), calretinin (CR), and choline acetyltransferase (ChAT). In our study we want to investigate the laminar distribution and the target cells of these subsets of VIP neurons in the mouse barrel cortex.

We used different intersectional mouse lines for VIP interneurons in fluorescent-insitu-hybridization (FISH). Sections of the barrel cortex was analyzed for the markers VIP, CCK, CR and ChAT. In acute brain slices of a new optogenetic mouse (Ai211) we performed whole-cell patch-clamp recordings.

VIP- and CR-expressing cells (VIP/CR) are predominantly located in the deeper portion of layer II/III whereas VIP- and CCK-expressing cells (VIP/CCK) preferred the region close to layer I. We found a overlap between VIP/CCK and VIP/CR neurons, accounting for around 20% and 40% of the total VIP cell population, respectively. Optogenetic stimulation of VIP/CR and VIP/CCK neurons in the Ai211 mouse lead to cell body limited generation of action potentials, but no synaptic inputs on pyramidal neurons were found. Our results will contribute to the distribution of VIP interneurons and their subgroups in the cortex, and test the sensitivity and specificity of intersectional mouse models for VIP neurons. In subsequent paired patch-clamp-recordings we will focus on the targets of these VIP interneuron subgroups.

Nanoscale architecture of the synaptic release site

Sofia Elizarova¹, Siqi Sun¹, Noa Lipstein¹

¹Leibniz-Forschungsinstitut für Molekulare Pharmakologie, Synapse Biology, Robert-Rössle-Str. 10 , 13125 Berlin, Germany

Neuronal communication in the central nervous system relies on a highly organized protein machinery that controls neurotransmitter secretion. The properties of the transmitted signal differ between synapse subtypes, and increasing evidence suggests that this synaptic diversity is based on differences in the nanoscale architecture of the synaptic vesicle release site. To systematically investigate how presynaptic proteins are spatially arranged at the release site in diverse synapse subtypes, we developed and validated a new knock-in mouse line that expresses UNC13A (Munc13-1) with a c-terminally fused SNAP-tag. This enables reliable and fast fluorescence tagging of endogenous UNC13A nanoclusters, that act as synaptic vesicle release sites, in the intact mouse brain. We combine super resolution microscopy techniques such as the recently established 10x expansion microscopy protocol and Stimulated emission depletion (STED) microscopy, to facilitate a detailed analysis of morphological release site parameters, which are necessary for understanding the functional diversity of synaptic function.

Neuronal alternative splicing of gephyrin C4 cassettes modulates condensate formation in vitro and synaptic scaffolding in cultured neurons

Filip Liebsch¹, Anne Bodenhausen¹, Fynn Eggersmann², Anna Lütz¹, Peter Kloppenburg², Günter Schwarz¹

¹University of Cologne, Institute of Biochemistry, Cologne, Germany

²University of Cologne, Biocenter, Institute for Zoology, and Cologne Excellence Cluster On Cellular Stress Responses in Aging-Associated Diseases (CECAD), Cologne, Germany

Gephyrin is the key postsynaptic scaffolding protein at glycinergic and a subset of gamma aminobutyric acid (GABA)-ergic inhibitory synapses. Neurons express different gephyrin splice variants; however, it is unknown whether all isoform act to the same extent as synaptic organizers. To characterize the scaffolding properties of neuronal gephyrin splice variants, specifically those differing in the incorporation of C4 cassettes, we studied the biophysical properties of recombinantly produced isoforms and assessed synaptic scaffolding as well as functional implications of fluorophore-tagged variants in dissociated neurons. Recombinantly produced isoforms, namely gephyrin P1 (without additional splice cassette), - C4a, - C4c, or - C4d, displayed similar binding affinities with a soluble pentameric model of the glycine receptor intracellular loops, as measured by isothermal titration calorimetry. Biomolecular condensate formation is a process that has been implicated in inhibitory postsynaptic density sheet formation. Interestingly, purified isoforms containing either C4a or C4d cassettes displayed more rapid phase separation with the model interaction partner than the other variants, as determined by time-resolved microscopy and turbidity kinetic assays. For the synaptic scaffolding analysis, the formation of cytosolic aggregates that are commonly observed upon exogenous gephyrin expression in neuronal and non-neuronal cells was circumvented by using adeno-associated virus-mediated expression of C4 isoforms in individual dissociated hippocampal CamKII-expressing neurons. An automated and quantitative analysis revealed that while P1 did not show any localization preference, C4a was enriched in the neuron's soma and distal localizations, while C4c and C4d localized mainly to distal inhibitory synapses. Since differences between P1 and C4c were observed, we focussed our functional analysis on these two variants by analyzing miniature inhibitory postsynaptic currents (mIPSCs) from cultured neurons expressing either of these isoforms. Our results suggest that inhibitory synapse heterogeneity may be influenced – at least in part – by mechanisms relating to C4 cassette splicing. Taken together, the alternative splicing of gephyrin could be one of the factors influencing the organization of molecules at diverse synapse populations.

Novel mechanisms underlying SynGAP syndrome and new strategies toward therapeutic intervention

Judith von Sivers^{1,2}, Benno Kuroopka³, Dietmar Schmitz^{1,2,4}, Sarah Shoichet^{1,2}, Nils Rademacher⁴

¹Charité - Universitätsmedizin Berlin, Neuroscience Research Center, Berlin, Germany

²Einstein Center for Neurosciences, Berlin, Germany

³Institute of Chemistry and Biochemistry, Freie Universität Berlin, Germany

⁴German Center for Neurodegenerative Diseases (DZNE), Berlin, Germany

SynGAP is a post-synaptic GTPase-activating protein, which negatively regulates the small GTPase Ras (Kim, et al. 1998). SynGAP is an essential inhibitor of synaptic strength and long-term potentiation (LTP) in dendritic spines (Komiyama, et al. 2002). De novo mutations in the SYNGAP1 gene cause a severe neurodevelopmental disease called SynGAP Syndrome, which is characterized by symptoms like intellectual disability, epilepsy, and autism spectrum disorder (Hamdan, et al. 2009). The current hypothesis to explain the disease mechanism focusses mainly on the overactive Ras-mediated exocytosis pathway of AMPA receptors, resulting in LTP occlusion (Gamache, et al. 2020). Nonetheless, current literature suggests the exocytosis of AMPA receptors cannot explain the phenotype completely.

We aim to get an unbiased understanding of synaptic Ras function beyond the current AMPA receptor hypothesis. We intend to identify novel dysregulated Ras targets in dendritic spines, that contribute to the molecular pathomechanism underlying SynGAP syndrome. By using liquid chromatography mass spectrometry, we sought out to identify novel synaptic interactors of Ras. Interestingly, we found that Ras is likely to interact with voltage gated ion channels. Additionally, we identified several heterotrimeric G protein subunits and a GPCR which suggests a role for Ras in synaptic GPCR signaling. The current focus of our research is the development of functional assays to explore the role of selected targets in the context of synaptic Ras and SynGAP function. For these purposes we have established a dimerization-dependent fluorescent Ras sensor, which enables us to monitor Ras activity in in vitro assays as well as in the context of living primary neurons (Kim, et al. 2019). We have combined live-cell-imaging of the Ras sensor with Ca-imaging in wild type and SynGAP knock down neurons, which allows for deeply dynamic analysis of Ras dynamics in the context of neuronal transmission in healthy and diseased neurons. Furthermore, we have established a human induced stem cell (hiPSC) line from a patient with SynGAP-Syndrome, serving as an additional model for analyzing Ras/SynGAP pathway regulation. Ultimately, we aim to use the Ras sensor system to screen for small modulators of the SynGAP/Ras pathway in a high throughput context in primary rodent neurons as well as iPSC-derived neurons. By using a library of FDA-approved drugs on a patient cell line, we will have a personalized and translational approach. Our results so far suggest new and unexpected roles for synaptic Ras, which might shed light on the mechanistical understanding of disease pathologies of neurodevelopmental disorders such as SynGAP Syndrome.

Gamache, T.R., Araki, Y., and Huganir, R.L. (2020). Twenty Years of SynGAP Research: From Synapses to Cognition. *J Neurosci* 40, 1596-1605. 10.1523/JNEUROSCI.0420-19.2020.

Hamdan, F.F., Gauthier, J., Spiegelman, D., Noreau, A., Yang, Y., Pellerin, S., Dobrzeniecka, S., Cote, M., Perreau-Linck, E., Carmant, L., et al. (2009). Mutations in SYNGAP1 in autosomal nonsyndromic mental retardation. *N Engl J Med* 360, 599-605. 10.1056/NEJMoa0805392.

Kim, J., Lee, S., Jung, K., Oh, W.C., Kim, N., Son, S., Jo, Y., Kwon, H.B., and Heo, W.D. (2019). Intensiometric biosensors visualize the activity of multiple small GTPases in vivo. *Nat Commun* 10, 211. 10.1038/s41467-018-08217-3.

Kim, J.H., Liao, D., Lau, L.-F., and Huganir, R.L. (1998). SynGAP: a Synaptic RasGAP that Associates with the PSD-95/SAP90 Protein Family. *Neuron* 20, 683-691. 10.1016/s0896-6273(00)81008-9.

Komiyama, N.H., Watabe, A.M., Carlisle, H.J., Porter, K., Charlesworth, P., Monti, J., Strathdee, D.J., O'Carroll, C.M., Martin, S.J., Morris, R.G., et al. (2002). SynGAP regulates ERK/MAPK signaling, synaptic plasticity, and learning in the complex with postsynaptic density 95 and NMDA receptor. *J Neurosci* 22, 9721-9732.

N-type calcium channels sustain vesicle recruitment at a mature glutamatergic synapse

Magdalena Wender¹, Grit Bornschein¹, Simone Brachtendorf¹, Stefan Hallermann¹, Jens Eilers¹, Hartmut Schmidt¹

¹Carl-Ludwig-Institut für Physiologie, Abteilung 2, Liebigstraße 27, 04103 Leipzig, Germany

Parallel fiber (PF) to Purkinje cell (PC) synapses in the mature cerebellum show pronounced and persistent facilitation during high-frequency activity, although they harbor only a single active zone with 2-3 release sites. Ultra-fast vesicle recruitment on the millisecond time-scale results in a temporary increase in vesicle-filled release sites (overfilling). This overfilling has been identified as the main mechanism of facilitation at PF synapses (Miki et al., 2016; Doussau et al., 2017). This process was found to be a least partially Ca^{2+} -dependent. The Ca^{2+} sources driving overfilling, however, remained elusive to date.

The composition of voltage-dependent Ca^{2+} channel (Ca_v) subtypes that gate action potential-evoked transmitter release changes during development at this synapse. N- and R-type Ca_v s lose their function in gating evoked release during postnatal maturation. In mature boutons, P/Q-type currents provide the almost exclusive trigger for evoked release. However, the N- and R-type Ca_v s remain present at active zones and continue contributing to presynaptic Ca^{2+} influx (Kusch et al., 2018). R-type currents were found to be required for the induction of presynaptic long term potentiation (Myoga and Regehr, 2011). However, the functional significance of N-type Ca_v s remained elusive in mature boutons. Here, we addressed the hypothesis that N- and R-type Ca_v s are engaged in ultra-fast vesicle recruitment during high-frequency PF-activity.

We stimulated PFs in the molecular layer and recorded excitatory postsynaptic potentials (EPSCs) from whole-cell patch-clamped PCs. We applied the subtype-specific blockers ω -Agatoxin (AgTx, P/Q-type), ω -Conotoxin (CTx, N-type) or SNX-482 (SNX, R-type).

During brief bursts of 5 APs we found that neither CTx nor SNX significantly affected the amplitudes of EPSCs nor the corresponding paired-pulse ratios (PPRs). To investigate vesicle recruitment during sustained activity, we analyzed cumulative EPSC amplitude plots of trains of 50 APs. We found that application of CTx but not SNX significantly reduced the slope of the line fits to the cumulative plots. This indicates that N-type but not R-type currents contribute to sustaining release during trains of APs.

As an additional measure of vesicle recruitment, we analyzed the recovery from steady-state following the train of APs. This analysis indicated that next to Ca^{2+} -dependent mechanisms, also Ca^{2+} -independent processes contribute to vesicle recruitment. In summary, our data combined with numerical computer simulations suggest that vesicle recruitment during brief bursts of APs is independent of Ca^{2+} influx through N- and R-type Ca_v s. However, N-type but not R-type currents significantly boosted steady-state vesicle recruitment during sustained high-frequency synaptic activity. Thus, in mature boutons N-type Ca_v s are significant for sustaining synaptic efficacy during periods of heavy use.

Miki T, Malagon G, Pulido C, Llano I, Neher E, Marty A (2016) Actin- and myosin-dependent vesicle loading of presynaptic docking sites prior to exocytosis. *Neuron* 91:808-823.

Doussau F, Schmidt H, Dorgans K, Valera AM, Poulain B, Isope P (2017) Frequency-dependent

mobilization of heterogeneous pools of synaptic vesicles shapes presynaptic plasticity. *Elife* 6:e28935.

Kusch V, Bornschein G, Loreth D, Bank J, Jordan J, Baur D, Watanabe M, Kulik A, Heckmann M, Eilers J, Schmidt H (2018) Munc13-3 is required for the developmental localization of Ca²⁺ channels to active zones and the nanopositioning of Cav2.1 near release sensors. *Cell Rep* 22:1965-1973.

Myoga MH, Regehr WG (2011) Calcium microdomains near R-type calcium channels control the induction of presynaptic long-term potentiation at parallel fiber to Purkinje cell synapses. *J Neurosci* 31:5235-5243.

Pentameric assembly of glycine receptor intracellular domains provides insights into gephyrin clustering

Guenter Schwarz¹

¹Universität zu Köln, Institut für Biochemie, Zulpicher Str. 47, 50674 Köln, Germany

Pentameric ligand-gated ion channels represent a large family of receptors comprising an extracellular domain, four transmembrane helices and a cytosolic intracellular domain (ICD). ICDs play important roles in receptor localization and trafficking, thus regulating synaptic activity and plasticity. Glycine and GABA type A receptor ICDs bind to the scaffolding protein gephyrin, a master regulator of inhibitory synapses. Here we report the use of yeast lumazine synthase as soluble pentameric protein scaffold for the study of receptor ICDs derived from GlyR α and β -subunits. We were able to create ICDs assemblies in a homo- (LS- β ICD) and hetero-pentameric state (LS- $\alpha\beta$ ICD) and provide first-in-class structural insights on their high structural flexibility using small angle X-ray scattering. We report a high-affinity interaction between the LS- $\alpha\beta$ ICD and gephyrin leading to the in vitro formation of high-molecular mega-Dalton complexes composed of three gephyrin trimers and three pentamers as basic building block. Depending on the stoichiometric ratios between gephyrin and LS-ICDs the formed complexes grow or shrink in size. In cells, LS-ICDs efficiently recruited gephyrin and were able to accumulate gephyrin at GABAergic synapses in neurons. Our findings collectively propose a new, potentially general, mechanistic concept for a gephyrin-dependent bridging of GlyRs at the inhibitory synapse.

Presynaptic precursor vesicles originate from the trans-Golgi, promoted by the small GTPase Rab2

Astrid G. Petzoldt¹, Torsten W. B. Götz¹, Dmytro Puchkov², Veronika Lysiuk¹, Stephan J. Sigrist¹

¹Freie Universität Berlin, Institut für Biologie, Takustr. 6, 14195 Berlin, Germany

² Leibniz-Forschungsinstitut für Molekulare Pharmakologie im Forschungsverbund Berlin e.V. (FMP), Campus Berlin-Buch, Robert-Roessle-Str. 10, 13125 Berlin, Germany

Reliable delivery of presynaptic material, including active zone and synaptic vesicle proteins from neuronal somata to synaptic terminals, is prerequisite for successful synaptogenesis and neurotransmission. However, molecular mechanisms controlling the somatic assembly of presynaptic precursors remain insufficiently understood. We show here that in mutants of the small GTPase Rab2 both active zone and synaptic vesicle proteins accumulated in the neuronal cell body at the trans-Golgi and were, consequently, depleted at synaptic terminals, provoking neurotransmission deficits. Ectopic presynaptic material accumulations consisted of heterogeneous vesicles and short tubules of 40x60 nm and segregated in subfractions either positive for active zone proteins or synaptic vesicle proteins and LAMP1, a lysosomal membrane protein. Genetically, Rab2 behaved epistatically over Arl8, a lysosomal adaptor controlling the axonal export of precursors. Collectively, we here identified a Golgi-associated assembly sequence for presynaptic precursor vesicle biogenesis controlled by Rab2-dependent protein export and sorting at the trans-Golgi.

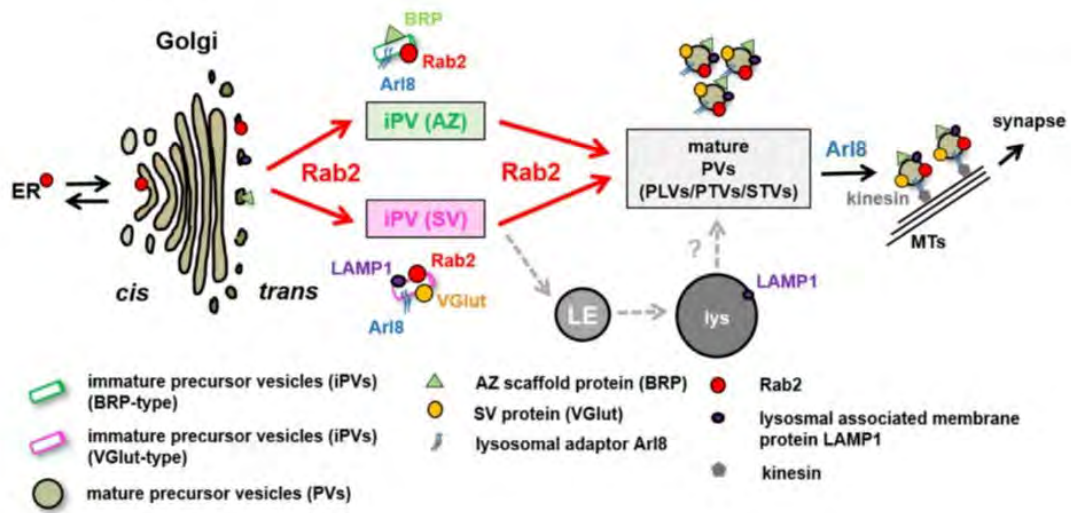

Quantifying the synaptic Ca^{2+} -binding kinetics of Synaptotagmin-1, the Ca^{2+} sensor for transmitter release in the forebrain

Grit Bornschein¹, Simone Brachtendorf¹, Abdelmoneim Eshra¹, Jens Eilers¹, Stefan Hallermann¹, Hartmut Schmidt¹

¹University of Leipzig, Medical Faculty, Carl-Ludwig-Institute for Physiology, Liebigstrasse 27a, 04103 Leipzig, Germany

The Ca^{2+} sensitivity of transmitter release is a major determinant of synaptic fidelity and plasticity. Two synaptotagmin (Syt) isoforms, Syt1 and Syt2, are the main Ca^{2+} sensors triggering action potential-mediated release in the brain; however, only Ca^{2+} binding to Syt2, the dominant isoform in the hindbrain, has been studied in detail ^{1,2}. For Syt1, the dominating sensor in the forebrain, similar quantitative detail from brain synapses is not currently available.

To quantify the Ca^{2+} -binding kinetics of Syt1 in the context of the intact release machinery we adapted a method combining Ca^{2+} -uncaging ¹⁻³, two-photon G/R Ca^{2+} -imaging and patch-clamp electrophysiology for pairs of connected layer 5 pyramidal neurons in the S1 somatosensory cortex of mature mice. To define the local intracellular free Ca^{2+} concentration ($[\text{Ca}^{2+}]_i$) at the release sensor, $[\text{Ca}^{2+}]_i$ was uniformly elevated in the presynaptic terminal from a caged Ca^{2+} compound by brief UV-flashes. Changes in the presynaptic G/R fluorescence were measured at individual boutons by point-mode two-photon imaging and converted to $\Delta[\text{Ca}^{2+}]_i$ based on cuvette calibrations. The corresponding EPSCs were recorded and synaptic delays and deconvolution-based release rates were quantified.

Release typically started at $\Delta[\text{Ca}^{2+}]_i$ above $\sim 4 \mu\text{M}$ and peak release rates increased until $\Delta[\text{Ca}^{2+}]_i$ of $\sim 25 \mu\text{M}$, saturating thereafter with no substantial further increase up to $\Delta[\text{Ca}^{2+}]_i$ of $\sim 100 \mu\text{M}$. Synaptic delays decreased concomitantly. In comparison to Syt2 ^{1,2}, the cooperativity of the $[\text{Ca}^{2+}]_i$ -dependency of Syt1-triggered release was similar (Hill coefficient of 4.2). However, the affinity of Syt1-triggered release was two-fold lower (KD of $20 \mu\text{M}$) than the affinity of Syt2-triggered release. These findings have implications for the reliability of cortical synaptic transmission and indicate that the Ca^{2+} influx-to-release coupling might be limited to smaller distances than previously thought.

References

1. Bollmann, J. H., Sakmann, B. & Borst, J. G. Calcium sensitivity of glutamate release in a calyx-type terminal. *Science* 289, 953–957 (2000).
2. Schneggenburger, R. & Neher, E. Intracellular calcium dependence of transmitter release rates at a fast central synapse. *Nature* 406, 889–893 (2000).
3. Eshra, A., Schmidt, H., Eilers, J. & Hallermann, S. Calcium dependence of neurotransmitter release at a high fidelity synapse. *eLife* 10; 10.7554/eLife.70408 (2021).

Receptor diversity in cholinergic and GABAergic synapses in *Drosophila*

Eleni Samara^{1,2}, Alexander Borst¹

¹Max Planck Institute for Biological Intelligence (In foundation), Germany

²Graduate School of Systemic Neurosciences, LMU Munich, Germany

Chemical synapses are juxtapositions that allow structural connection and functional communication between neurons. A key molecular element for the synaptic information processing is the neurotransmitter receptors, which can control the kinetics of signal transduction and hence postsynaptic activity by diversifying in fast ionotropic and slow metabotropic receptors. In the visual system of *Drosophila melanogaster*, motion sensing neurons receive input from a set of cholinergic and GABAergic neurons. In addition to the inputs' unique activity profiles, the post-synaptic receptors could influence the computation based on their temporal response properties. In order to investigate this, we try to allocate receptor types along the different cholinergic and GABAergic synapses by employing the vast genetic toolbox of *Drosophila*. To create a synaptic receptor map, we use pan-presynaptic markers and contact-based synaptic markers for visualizing the synaptic compartments. We tag receptor candidates with fluorescent proteins or affinity tags and visualize them with nanobodies for minimized linkage error. Ultimately, our work will help us understand visual information processing at the molecular level.

Regulation of presynaptic membrane homeostasis by BAR domain proteins

Agata Witkowska¹, Tim Berneiser¹, Volker Haucke¹

¹Leibniz-Forschungsinstitut für Molekulare Pharmakologie (FMP), Molecular Pharmacology and Cell Biology, Robert-Roessler-Strasse 10, 13125 Berlin, Germany

Efficient neuronal communication relies on the activity-dependent exo- and endocytosis of synaptic vesicles (SVs) at the active zone (AZ). To sustain neurotransmission exocytosed material (proteins and lipids incorporated into the plasma membrane during fusion of SVs) needs to be cleared from AZ release sites by endocytosis, followed by reformation of SVs that refill the SV pool. Various modes of SV endocytosis depend on the activity of bin-amphiphysin-rvs (BAR) domain proteins, many of which are found to be highly expressed in the brain and enriched at synapses. BAR proteins sense and stabilize membrane curvature and often act as hubs connecting various machineries (such as actin or dynamin) facilitating membrane internalization. There are early-acting F-BAR domain proteins for example syndapin 1, as well as late acting N-BAR domain proteins such as endophilins that couple endocytic membrane constriction to membrane fission by dynamin. Work over decades has established that SV exo- and endocytosis are homeostatically balanced, i.e. for each SV that fuses the equivalent membrane complement of one SV is internalized. How this close coupling of SV exo- and endocytosis is achieved in molecular terms and how exo-endocytic membrane homeostasis is controlled are critical, yet still not fully solved questions. In this work we screen the ability of F-BAR domain proteins for coupling synaptic vesicle exo- and endocytosis by combining experiments in cultured neurons, with reconstitution experiments with model membranes and purified proteins. We find that members of the CIP4 (Cdc42-interacting protein 4) subfamily of F-BAR proteins are presynaptically enriched and their removal slows down SV endocytosis. It was suggested in the past that exo-/endocytic coupling at the synapses could be mediated by changes in the physical properties of the plasma membrane such as membrane tension. Here we established an in vitro assay coupling membrane fusion-driven membrane alteration with induction of remodeling by F-BAR domain proteins. We observe membrane tension-driven protein clustering that is dependent on the disordered region. Finally, we propose a model of endocytosis induction involving structural rearrangements within F-BAR proteins leading to membrane remodeling as well as recruitment of the downstream factors such as dynamin.

Regulatory Functions of Extracellular-Signal Regulated Kinases (ERK) in the Contralateral Hemisphere of the Mouse Somatosensory Cortex One-Week after Traumatic Brain Injury

Celine Gallagher¹, Natascha Ihbe¹, Thomas Mittmann¹

¹Institute of Physiology, University Medical Centre of the Johannes Gutenberg University, 55128 Mainz, Germany

Despite decades of research that has been dedicated to understanding the underlying pathophysiology of traumatic brain injury (TBI), it remains one of the leading causes of death in developed countries worldwide. It has been found that following a unilateral injury to the brain, neurons in the functionally connected region of the hemisphere contralateral to that of the initial lesion site undergo adaptive functional alterations. In this context, our lab recently disclosed a TBI-induced contralateral hyperexcitability at an acute timepoint post-TBI (Ihbe et al. 2022). This phenomenon is termed 'transhemispheric diaschisis', and has been of growing interest in our lab. Quantitative mass spectrometry analysis of the contralateral cortical GABAergic interneurons at one-week post-TBI showed a significant upregulation of extracellular-regulated kinase (ERK)1 and a significant downregulation in the scaffolding protein IQGAP1. While investigating whether this effect was seen in the entire cortex or exclusively in cortical GABAergic-interneurons, we evaluated the expression level of ERK and IQGAP1 in whole cortical lysates. Our well established controlled cortical impact (CCI) model of TBI in one hemisphere of the somatosensory cortex was applied in GAD67-GFP knock-in mice at the age of 21 days under anaesthesia. After a survival time of one week, the animals were decapitated under anaesthesia and we performed Western Blots from whole cortical lysates. To our surprise, both ERK1 and ERK2 were not upregulated, but rather were significantly downregulated in whole cortical lysates. To investigate if this regulation in expression of ERK can affect cortical network activity, we mimicked the downregulation of ERK during electrophysiological experiments in acute coronal slices by pharmacological inhibition of ERK through bath application of the specific ERK-inhibitor FR180204 (25µM). We performed extracellular recordings on a 60 electrode multielectrode array (MEA) system (Multichannel Systems) and recorded spontaneous as well as evoked synaptic signals in layers II/III of the somatosensory cortex. Two different age groups were analyzed. The results showed a significant hyperexcitability in presence of the ERK inhibitor in the somatosensory cortex in both age groups in terms of spontaneous activity, as measured by the spike frequency. Furthermore, electrical stimulation of ascending or horizontal cortical fibers led to an increased amplitude of fEPSPs in both age groups (P14-P16 and P27-29) in presence of FR180204. Taken together, these data reveal a neuron-type specific upregulation of ERK selectively in GABAergic interneurons one-week after TBI, while overall in the somatosensory cortex ERK is rather downregulated in the contralateral hemisphere. Importantly, pharmacological downregulation of ERK mimicked our previously observed phenotype of a cortical hyperexcitability under conditions of a unilateral TBI.

This work is supported by a grant to TM (DFG, CRC 1080, C02)

Relaxin' cortical circuits: understanding the effect of relaxin on synaptic transmission within cortical circuits

Sadat Hodzic¹, Therese Riedemann¹

¹Ludwigs-Maximilians-Universität, München, Biomedizinisches Centrum, Physiologische Genomik, Großhadener Straße, 9, 82152 Planegg-Martinsried, Germany

The peptide relaxin is a heterodimeric peptide whose biological effect is mediated via the family of G-protein coupled receptor Relaxin Family Peptide Receptor 1 (RXFP1). Relaxin was initially described as facilitator of parturition in reproductive endocrinology in the late 20s of the last century. However, the actions of relaxin are not limited to reproductive organs but also affect cardiovascular and renal physiology. Although studies suggest a wide distribution of RXFP1 in different brain areas, little is known about the biological actions of the peptide on the brain. Given the RXFP1 expression pattern within the brain, it has been implicated in emotional memory.

Single-cell sequencing data show robust mRNA levels of relaxin-1 in a subgroup of GABAergic interneurons, namely somatostatin-expressing interneurons, suggesting that relaxin-1 might act as a neuropeptide inside the brain. This hypothesis is supported by the finding that intracerebroventricular injection of the synthetic peptide human relaxin-2 (H2-relaxin) has analgesic effects on thermic and mechanic pain perception in mice. The anterior cingulate cortex is at the core of the pain matrix and plays a prominent role in nociception and pain processing. Interestingly, RXFP1 is expressed by around 80% of all excitatory neurons of the cingulate cortex suggesting that H2-relaxin might well act as a neuromodulator of cortical circuits.

Therefore, we studied the effect of H2-relaxin on synaptic transmission within the anterior cingulate cortex using in vitro whole-cell patch clamp recordings. Recordings were either obtained from infragranular pyramidal neurons or fast-spiking interneurons or from supra- or infragranular SOM-INs in 300 µm-thick acute coronal brain of adult animals (postnatal day 28 and older). Experiments were performed on wild-type mice and on the following transgenic mouse lines: 1) the GIN mouse line where a subset of somatostatin-expressing interneurons (SOM-INs) expresses the enhanced green fluorescent protein (eGFP) or 2) the Nos-1 CreERT2; Sst-Flp-Ai65 mouse line where NOS-1 expressing SOM-INs express td-tomato.

In pyramidal cells, we found that exposure to H2-relaxin caused a sustained and reversible inward current suggesting a direct postsynaptic effect. In agreement with that, we found that H2-relaxin resulted in a depolarization of the resting membrane potential and an increase in the action potential discharge frequency. In contrast, no such inward current was observed in either SOM-IN subtype. Nonetheless, H2-relaxin exposure resulted in a robust increase in the firing frequency of SOM-INs and a small but significant decrease of the resting membrane potential. Interestingly, we did not detect a postsynaptic H2-relaxin effect on fast-spiking interneurons.

In addition, we found that RXFP1 activation caused a significant increase in the frequency of spontaneous inhibitory postsynaptic currents (sIPSCs) onto pyramidal cells whereas no such effect was visible in SOM-INs. However, the frequency of spontaneous excitatory postsynaptic currents was significantly increased in SOM-INs upon H2-relaxin exposure.

Altogether, these data suggest that H2-relaxin acts as a powerful neuromodulator of cortical circuits.

Role of activin signaling in GABAergic inhibition in hippocampal granule cells and its implications in depression

Sriity Melley Sadanandan¹, Fang Zheng¹, Liubov S Kalinichenko², Christian P Müller²,
Christian Alzheimer¹

¹Friedrich-Alexander-Universität Erlangen-Nürnberg, Institute of Physiology and Pathophysiology, Universitätstrasse 17, 91054, Erlangen, Germany

²Department of Psychiatry and Psychotherapy, Universitätsklinikum, Friedrich-Alexander-Universität Erlangen-Nürnberg, Schwabachanlage 6, 91054 Erlangen, Germany

Adolescence is a critical period associated with behavioral and emotional changes. Aversive challenges like chronic stress during this period may increase the likelihood of neuropsychiatric disorders later in life. However, the pathophysiological mechanisms rendering the adult brain susceptible remain largely unknown. Studies have indicated an increase in GABA_A receptors during this late developmental stage. Our previous work showed that activin, a member of the TGF- β family, modulates hippocampal GABAergic inhibition and impacts anxiety-like behavior, as indicated by a comparison between wild type mice and transgenic mice expressing a dominant-negative mutant of activin receptor IB (dnActRIB). To compare the neuronal circuitry during adolescence (P30-45) and in adulthood (P90-P120), we first systemically examined GABAergic inhibition onto granule cells in dentate gyrus, a hippocampal region closely linked to the antidepressant effect of activin signaling. Whole-cell voltage-clamp recordings from hippocampal slices showed a significant increase in GABAergic inhibitory postsynaptic currents (IPSCs) in granule cells from adolescent mice, compared to those from adult mice. Interestingly, acutely applied corticosterone produced mixed responses of IPSCs in adult dorsal slices, but a uniform suppression in ventral ones, indicating differential effects of the stress hormone along the hippocampal longitudinal axis. To elucidate the mechanisms involved in adolescent stress and its later effects in adulthood, we established a behavioral model by administering corticosterone during adolescence (P30-P45). A depression-like phenotype in adulthood was manifested in forced swim test with higher immobility in wild type mice, but not in dnActRIB mice. Preliminary electrophysiological evidence suggests that in the dentate gyrus network, activin signaling modulates the long-term impact of adolescent stress on GABAergic inhibition.

Role of synaptic vesicle refilling on robust synaptic transmission in the auditory system

Erika Pizzi¹, Jennifer Winkelhoff¹, Eckhard Friauf¹

¹University of Kaiserslautern, Animal Physiology Group, Department of Biology, Erwin-Schroedinger Straße-13, 67663 Kaiserslautern, Germany

Inhibitory glycinergic connections from the medial nucleus of the trapezoid body (MNTB) to the lateral superior olive (LSO) are tuned for synaptic reliability and temporal precision, even during sustained high-frequency stimulation (60 s; >100 Hz). Reliability, precision and resilience are achieved by a high quantal content and efficient replenishment of the readily releasable pool (RRP) in MNTB axon terminals (Müller et al., 2022; DOI 10.1113/JP280403). During sustained neurotransmission, the RRP is continuously replenished with preformed or recycled synaptic vesicles (SVs), whereby the latter need to be refilled with neurotransmitter. The refilling process is driven by an electrochemical gradient generated by the vacuolar H⁺-ATPase (V-ATPase) and maintained by the Na⁺/H⁺ exchanger (NHE) (Farsi et al., 2017; DOI 10.1002/bies.201600240). The molecular bases of the RRP replenishment at MNTB-LSO synapses are still poorly understood. Here, we investigated the role of SV recycling at these robust inhibitory synapses upon pharmacological inhibition of SV refilling during sustained high-frequency stimulation.

Whole-cell recordings were performed on LSO neurons in acute slices from juvenile mice at physiological temperature. Evoked inhibitory postsynaptic currents (eIPSCs) were recorded while electrically stimulating MNTB fibers at 10-200 Hz in 60-s trains. Each train was followed by a recovery period (60 s|1 Hz). SV refilling was inhibited by blocking V-ATPase and NHE with folimycin/bafilomycin and EIPA, respectively (1-5 µM, 30-60 min wash-in; 100 µM, 10 min).

Controls maintained stable steady-state amplitudes at 40 % of the baseline at 50 Hz. Upon inhibiting V-ATPase, short-term depression (STD) was more pronounced, indicated by steady-state eIPSC amplitudes of 10 %. Despite a significant decline in the RRP (3-fold vs control), MNTB-LSO synapses could still recover considerably from STD, although only partially (30-50 % of baseline level at 10-200 Hz). In controls, fractional recovery was total (100 %), whereas it was significantly smaller upon V-ATPase inhibition (70 %). We also stimulated MNTB-LSO synapses with 24'000 stimuli for 4-min|100-Hz. At the train's end, eIPSC amplitudes had declined to 5 % in controls, whereas the level was as low as 1 % after V-ATPase inhibition. Remarkably, recovery from STD (3-min|1-Hz) still occurred, reaching 30 % of the baseline.

Simultaneous inhibition of both V-ATPase and NHE caused a decrease in the steady-state amplitudes at 0 % and recovery from STD was 3-fold lower compared to blocking the V-ATPase alone.

Collectively, our results shed light on the synaptic performance of MNTB-LSO synapses under exhausting activity, in particular the role of SV refilling during prolonged high-frequency stimulation. Only a simultaneous inhibition of V-ATPase and NHE together leads to a collapse of synaptic transmission. We are not aware of any other synapse type that is as fatigue-resilient as MNTB-LSO synapses. We conclude that preformed SVs enable the remarkably reliable and temporally precise performance of MNTB-LSO inputs only at the beginning of the stimulation train, thus for tens of seconds. Consequently, RRP replenishment through recycled SVs becomes crucial only when sustained high-frequency stimulation exhausts the reserve pool.

Sex-dependent BDNF-mediated effects of Fingolimod on the architecture of mouse hippocampal neurons

Aiswaria Lekshmi Kannan¹, Martin Korte², Marta Zagrebelsky¹

¹TU Braunschweig, Zoological Institute, Division of Cellular Neurobiology, Spielmannstr. 7, 38106 Braunschweig, Germany

²Helmholtz Center for Infection research, Braunschweig, Germany

Brain derived neurotrophic factor (BDNF) is one of the most extensively studied neurotrophins in the mammalian brain. The effects of BDNF on the brain synapses and neuronal architecture stem from complex downstream signalling cascades mediated via its receptor TrkB. Impaired BDNF/TrkB signalling has been associated with several neurological disorders. Among the therapeutic strategies developed to promote the synthesis of endogenous BDNF is the use of the BDNF-inducing drugs. Among them, a treatment with Fingolimod has been shown both in vitro and in vivo to promote BDNF synthesis and release and exert BDNF-dependant neuroprotection. Estrogens are a group of steroid sex hormones synthesised by neurons and astrocytes predominantly in females. In the hippocampus, estradiol plays a crucial role in synaptic plasticity and regulates the expression of several crucial genes, including BDNF. Some studies show that in the hippocampus, BDNF levels are higher during the proestrous and estrous phase, when the amount of estradiol is high. Moreover, differences in the amount of BDNF mRNA were shown in male and female mice. Taken together the above suggests the possibility of a sex-specific response to the BDNF-inducing drug Fingolimod. Addressing this question is highly relevant in view of possible differences in the therapeutic outcome following a Fingolimod treatment.

Here, we investigated the BDNF-dependent effects of Fingolimod on the neuronal architecture in both male- and female-derived mouse primary hippocampal neurons. A 24-hour application of Fingolimod to organotypic hippocampal cultures (DIV 20-21), shows an increase in dendritic spine density for the pyramidal neurons both in male and female hippocampal cultures compared to the control condition. However female-derived neurons show a significantly higher increase in dendritic spine density after Fingolimod treatment as compared to males. In addition, sex-specific differences in the dendritic spine dynamics could be observed in response to Fingolimod. Female neurons show a lower amount of lost and gained dendritic spines after Fingolimod treatment as compared to male neurons. These results indicate that mouse neurons respond differently to the BDNF inducing drug Fingolimod in a sex-specific manner, with female neurons showing a higher sensitivity to it. Whether these effects are BDNF-dependant and result in sex-specific functional alterations is currently investigated by co-application of Fingolimod and TrkB-receptor bodies (TrkB-Fc).

This work is supported by a grant from the Deutsche Forschungsgemeinschaft to Martin Korte and Marta Zagrebelsky

Short-term plasticity of non-calyceal inputs in the medial nucleus of the trapezoid body

Laura Console-Meyer¹, Felix Felmy¹

¹Institute for Zoology, University of Veterinary Medicine Hannover, Germany

The calyx of Held synapses dominate the excitation at neurons in the medial nucleus of the trapezoid body (MNTB). This large glutamatergic, somatic synapse is considered to generate faithful one-to-one transmission, converting presynaptic into postsynaptic action potentials. Next to a single calyx of Held input, MNTB neurons receive excitatory synapses on their elaborated dendrites. These non-calyceal synapses generate small EPSCs that are slower compared to the calyx of Held input. Functionally the summed action of these non-calyceal synapses appears capable of generating temporally imprecise action potentials. The short-term dynamics of these non-calyceal inputs are unexplored and therefore their functional interpretation remains largely unclear.

We used in vitro whole-cell patch clamp recordings from MNTB neurons combined with afferent fibre stimulation in acute brain slices of postnatal day ~30 gerbils to determine the synaptic short-term plasticity of summed non-calyceal inputs. Under conditions of near physiological temperature and extracellular calcium concentration non-calyceal inputs showed a transient facilitation followed by a minor depression. At stimulation frequencies above 50 Hz these inputs facilitated up to two fold over the first five stimulation pulses before dropping to initial or sub-initial values. Below 50 Hz stimulation frequency, the non-calyceal inputs increased facilitation over several stimulation pulses. This increased EPSC size maintained until the end of our 30 stimulation pulses within the train. At 200 Hz stimulation frequency facilitation was calcium dependent, as elevating external calcium to 2.5 mM abolished the transient EPSC increase. During the train stimulation, the fraction of asynchronous release seemed to increase. Analysing the charge transfer showed that the released amount of vesicles during the stimulation train appeared to be invariant between the external calcium conditions at 200 Hz stimulation frequency. Under elevated calcium concentrations, the recovery from the depression was biphasic and completed after 15 s.

Taken together, the excitatory non-calyceal inputs facilitate and lose temporal precision during stimulation trains. Their vesicular replenishment appears largely insensitive to alterations in calcium concentrations at physiological levels. Thus, non-calyceal inputs are suited to generate a continuous depolarisation level during ongoing activity.

Single-molecule imaging of synaptic vesicle condensates

Christian Hoffmann¹, Jakob Rentsch², Taka Tsunoyama³, Akshita Chhabra¹, Gerard Aguilar Perez¹, Franziska Trnka¹, Marcelo Ganzella⁴, Akihiro Kusumi³, Helge Ewers², Dragomir Milovanovic¹

¹DZNE - Deutsches Zentrum für Neurodegenerative Erkrankungen, Molecular Neuroscience, Charitéplatz 1, 10117 Berlin, Germany

²Institute for Chemistry and Biochemistry, Freie Universität Berlin, 14195 Berlin, Germany.

³Okinawa Institute of Science and Technology Graduate University (OIST), 904-0495 Okinawa, Japan

⁴Department of Neurobiology, Max Planck Institute for Biophysical Chemistry, 37077 Göttingen, Germany

Neuronal transmission relies on the regulated secretion of neurotransmitters, which are packed in synaptic vesicles (SVs). Hundreds of SVs accumulate at synaptic boutons. Despite being held together, SVs are highly mobile, so that they can be recruited to the plasma membrane for their rapid release during neuronal activity. However, how such confinement of SVs corroborates with their motility remains unclear. To bridge this gap, we employ ultrafast single-molecule tracking (SMT) in the reconstituted system of native SVs and in living neurons. Synapsin 1/SVs form condensates with liquid-like properties in which synapsin 1, despite pronounced confinement, maintains its ultrafast diffusion at short time and length scales. We further use two-color SMT in living axons to demonstrate that synapsin 1 drives the accumulation of SVs in presynaptic compartments. Even the short intrinsically-disordered fragment of synapsin 1 was sufficient to rescue the stereotypic diffusion pattern of SVs. Together our data show that synapsin 1 condensation is sufficient to guarantee reliable confinement and the formation of mesoscale domains of SVs at synapses *in vivo*.

Species-specific adaptation for ongoing high-frequency action potential generation in MNTB neurons

Nikolaos Kladisios^{1,2}, Kathrin D. Wicke^{1,2}, Christina Pätz¹, Felix Felmy¹

¹University of Veterinary Medicine Hannover Foundation, Institute of Zoology, Bünteweg 17, 30559 Hannover, Germany

²Hannover Graduate School for Neurosciences, Infection Medicine and Veterinary Sciences (HGNI)

Comparative analysis of evolutionary conserved neuronal circuits between phylogenetically distant mammals highlights the relevant mechanisms and their specific adaptations to information processing. The medial nucleus of the trapezoid body (MNTB) is a conserved mammalian auditory brainstem nucleus and important for temporal processing. While MNTB neurons have been extensively investigated, an electrophysiological comparative analysis between phylogenetically distant mammals concerning input-output functions and spike generation is missing.

We used whole-cell patch clamp recordings from visually identifiable MNTB neurons in acute brain slices of *Meriones unguiculatus* (gerbil) and *Phyllostomus discolor* (bat) to determine the membrane biophysics of synaptically evoked input-output functions. Employing dynamic clamp recordings allowed us to disentangle the contribution of short-term plasticity in the adaptive behavior of this nuclei for each species. To understand the supra-threshold output rate and precision we examined the membrane, synaptic and sodium current inactivation properties in bat and in gerbil.

Between the two species, the membrane properties of MNTB principal cells were similar. Calyx of Held mediated EPSCs were smaller and slightly slower and the frequency dependence of short-term plasticity (STP) less pronounced in bats. Simulating synaptic train stimulations in dynamic clamp revealed that MNTB neurons fired reliably, with decreasing success rate near conductance threshold and at increasing stimulation frequency. Driven by STP-dependent conductance decrease, the latency of evoked action potentials increased during the train stimulations. The spike generator showed a temporal adaptation at the beginning of train stimulations that can be explained by sodium current inactivation. Compared to gerbils, the spike generator of bats sustained higher frequency input-output functions independent of input conductance. Therefore, calyceal inputs promote information transfer with high fidelity, but with unexpected susceptibility to temporal variance, and bat MNTB neurons are especially suited to sustain high-frequency input-output functions, as an adaptation to sensory processing.

S-SCAM/MAGI2 is essential for synapse formation

Nina Wittenmayer^{1,2}, Sebastian Kügler³, Jeong Seop Rhee⁴, Julio S. Viotti^{2,5}, Thomas Dresbach²

¹Institute for Translational Medicine, Am Sandtorkai 76, 20457 Hamburg, Germany

²Institute for Anatomy and Embryology, University of Goettingen Medical Center, Goettingen, Germany

³Department of Neurology, Viral Vectors Lab, University Medicine Göttingen, Göttingen, Germany

⁴Neurophysiology Group, Max Planck Institute for Multidisciplinary Sciences, Göttingen, Germany

⁵Interdisciplinary Institute for Neuroscience, CNRS UMR 5297, University of Bordeaux, Bordeaux, France

Synapse formation is critical for the wiring of neural circuits in the developing brain. The synaptic scaffolding protein S-SCAM/MAGI2 has important roles in the assembly of signaling complexes at postsynaptic densities. However, the role of S-SCAM for the establishment of the entire synapse is not known. Here, we report massive effects of S-SCAM knockdown on the number of synapses in early stages of network development. In vivo knockdown during the first three postnatal weeks reduced the number of dendritic spines in the rat brain neocortex. Knockdown of S-SCAM at the onset of synaptogenesis in cultured hippocampal neurons severely reduced the clustering of both pre- and postsynaptic components. This included synaptic vesicle proteins, pre- and postsynaptic scaffolding proteins, and cell adhesion molecules, suggesting that entire synapses fail to form. Correspondingly, functional and morphological characteristics of developing neurons were affected by reducing S-SCAM protein levels: neurons displayed severely impaired synaptic transmission and reduced dendritic arborization. A next generation sequencing approach showed normal expression of housekeeping genes and genes encoding for cytoskeletal proteins, but changes of expression levels in 39 synaptic signaling molecules. These results indicate that S-SCAM mediates the recruitment of all key classes of synaptic molecules during synapse assembly and is critical for the development of neural circuits in the developing brain.

Human iPSC-derived neurons have large presynaptic action potentials

Torsten Bullmann¹, Andreas Ritzau-Jost¹, Thomas Kaas¹, Anne Wöhner¹, Toni Kirmann¹, Sila Rizalar^{2,3}, Max Holzer⁴, Jana Nerlich¹, Christian Geis⁵, Jens-Karl Eilers¹, Robert Joahannes Kittel⁶, Thomas Arendt⁴, Volker Hauke^{2,3}, Stefan Hallermann¹

¹Leipzig University, Carl-Ludwig-Institute for Physiology, Liebigstraße 27, 04103 Leipzig, Germany

²Leibniz-Forschungsinstitut für Molekulare Pharmakologie (FMP), Berlin, Germany

³Freie Universität Berlin, Faculty of Biology, Chemistry, Pharmacy, Berlin, Germany

⁴Leipzig University, Paul Flechsig Institute for Brain Research, Medical Faculty, Leipzig, Germany

⁵Jena University Hospital, Section Translational Neuroimmunology, Department of Neurology, Jena, Germany

⁶Leipzig University, Institute of Biology, Department of Animal Physiology, Leipzig, Germany

The amplitude and the duration of presynaptic action potentials critically control neurotransmitter release. The properties of presynaptic action potentials remain poorly understood because measurements with high temporal resolution are technically challenging. Presynaptic action potentials have so far only been measured at a limited number of vertebrate but not human neurons. We therefore performed patch-clamp recordings from presynaptic boutons of cultured neurogenin2-induced human iPSC-derived neurons. We first measured basic morphological, molecular, and functional parameters of the soma, axon, and synapses after 3 to 9 weeks of cultivation in four different established media. Surprisingly, the medium had little impact on the studied parameters. On the morphological level, cell size continuously increased and the proportion of cells with more than one axon initial segment decreased from approximately 1/3 to 1/10 during maturation from 3 to 9 weeks. On the molecular level, the amount of tau protein in the axon strongly increased. On the functional level, the resting membrane potential decreased and plateaued after 6 weeks. Somatic action potentials were reliably elicited, with decreasing width and increasing frequency throughout maturation. Spontaneous and evoked postsynaptic excitatory currents occurred more reliably in cells older than 6 weeks. High-frequency synaptic transmission between 6 to 9 weeks old cells exhibited comparable little short-term depression up to a frequency of 100 Hz. Finally, we performed current-clamp recordings with high temporal resolution from axons of 6 to 9 weeks old neurons. The presynaptic action potentials had large amplitudes of approximately 100 mV and short durations of 0.5 ms at 37°C. These parameters are similar to presynaptic action potentials of cortical pyramidal neurons in mature mice and argue, together with the high-fidelity synaptic transmission, for well-matured presynaptic mechanisms in the here-studied 6 to 9 weeks old human neurons. Our results establish iPSC-derived cells as a model for high-resolution biophysical analyses of presynaptic function of human neurons.

Synaptic Cleft Proteins Form an Outer Enclosure of the Trans-Synaptic Nanocolumn

Paulina Nemcova^{1,2}, Hannes Beckert³, Julia Wolf^{1,2}, Susanne Schoch², Dirk Dietrich¹

¹Department of Neurosurgery, University Hospital Bonn, Bonn, Germany

²Department of Neuropathology, University Hospital Bonn, Bonn, Germany

³Microscopy Core Facility, Medical Faculty, University of Bonn, Bonn, Germany

The efficiency of synaptic transmission is shaped by the non-uniform distribution of vesicle-release proteins at the presynapse, scaffolding, and receptor proteins at the postsynapse. Non-uniform protein distribution across the synaptic subcompartments was shown to form functional nanodomains in which the high local density of presynaptic Rab3-interacting molecule (RIM) proteins aligns with regions of the high local density of postsynaptic and scaffolding molecules. Given the low affinity of AMPA receptors to glutamate, the receptor activation diminishes the further the receptor is located from the vesicle release site. Nanoscale alignment, therefore, exposes the receptors to a high concentration of released neurotransmitters, resulting in a facilitation of neurotransmission. However, while previously-applied superresolution microscopy allowed to map of the distribution and alignment of specific protein types, the picture of overall cluster distribution within the synapse and the characteristic of the cluster as a whole, including the network of diverse synaptic proteins, not a single protein type, is missing. Of outstanding interest to characterize the nanoscale synaptic distribution is the distribution of cleft proteins. It is of utmost importance to complete the view on the functional synaptic nanodomains by mapping the pathways of neurotransmitter diffusion and possible high-density obstacles, slowing or even completely hindering the neurotransmitter diffusion. In this work, we described the distribution and density profile of the protein milieu of the synapse, with a particular focus on the hypothesized barrier machinery of the cleft. We used volume electron microscopy (FIB-SEM) on brain slices stained with PTA, a metal with a particular affinity for protein groups, and second-moment spatial statistics to address these hypotheses. Our results suggest novel views on presynaptic and cleft proteins. The distribution of presynaptic high-density regions is bimodal, reminiscent of a combination of line- and grid-like architecture. High-density regions of the cleft preferentially accumulate at the outer rim of the trans-synaptic nanocolumn. The outer enclosure of the trans-synaptic nanocolumn by cleft proteins is characterized by the relative increase of protein density up to 40%. This finding implies possible roles of cleft proteins in limiting the neurotransmitter diffusion from the receptor cluster or limiting the mobility of AMPA receptors away from the cluster, thus regulating their aligned position with the presynaptic release site.

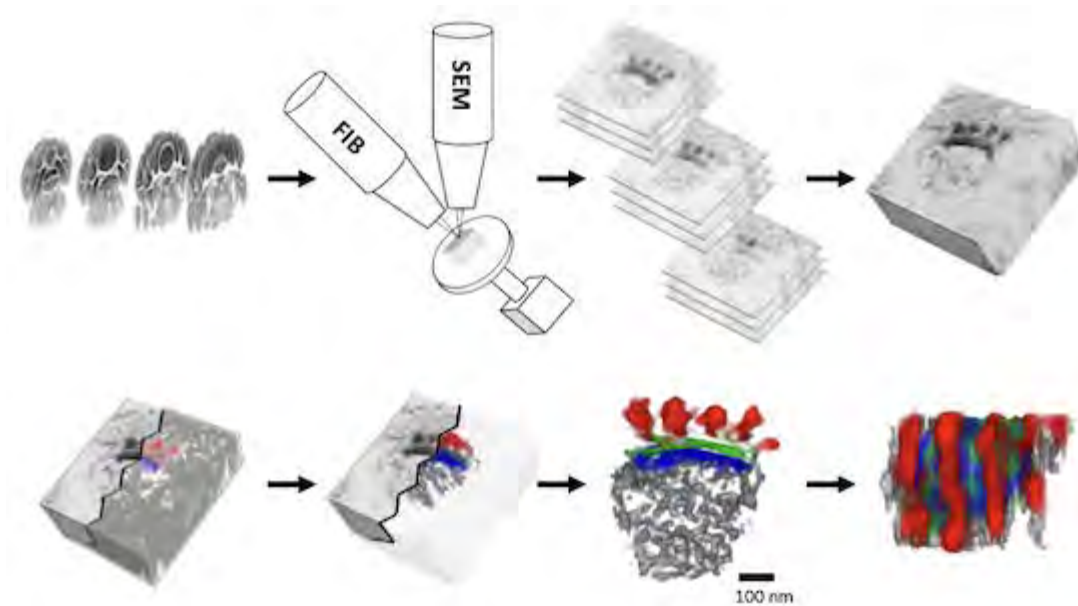

Acquisition and processing of 3D electron microscopy data for characterization of protein clusters and trans-synaptic nanocolumns. Cerebellar brain slices are stained with phosphotungstic acid, embedded in resin, and subjected to dual-beam (FIB for milling; SEM for imaging) 3D electron microscopy leading to a stack of 2D SEM images. Synaptic subcompartments are classified using Ilastik Pixel Classification routines from drift-corrected SEM image stacks. The following pseudocolors illustrate presynaptic proteins (in red), cleft proteins (in green), postsynaptic proteins (in blue), and spine elements (in gray). The pixel-classified synaptic subcompartments are transformed to cross- or top-views for downstream analysis.

Synaptic transmission is affected by the lack of plasmalogens

Bárbara Catarina Correia^{1,2}, Jaqueline Zortéa², Pedro Brites²

¹ICBAS - Instituto de Ciências Biomédicas Abel Salazar, Neurolipid Biology, R. Jorge de Viterbo Ferreira 228, 4050-313 Porto, Portugal

²Instituto de Investigação e Inovação em Saúde - i3S, Neurolipid Biology, Rua Alfredo Allen, 208, 4200-135 Porto, Portugal

Plasmalogens are a class of ether-phospholipids highly enriched in the nervous tissue, and their deficiency leads to a developmental disorder known as Rhizomelic Chondrodysplasia Punctata (RCDP). RCDP patients display neurologic alterations, with severe psychomotor impairment, epilepsy, and progressive impairments of visual-evoked and brain-evoked potentials, highlighting the relevance of plasmalogens in the nervous tissue. Neurons are specialized cells capable of communicating with other neurons and with other cells through synapses. Synaptic dysfunction has been shown to underlie many brain disorders. Therefore, understanding the consequences and mechanisms of plasmalogen loss to synapses will provide a better understanding of RCDP and other neurological disorders that have plasmalogen deficits. To investigate plasmalogens' function and the consequences of their deficiency, we use the Gnpat knockout (KO) mouse, with a generalized plasmalogen defect and a conditional Gnpat allele (Gnpat floxed mice), in which neuronal expression of cre recombinase causes plasmalogen-specific defects in neurons. For this work, we performed the analysis of the cortical proteome of WT and Gnpat KO mice. The analysis identified a set of proteins that are either up- or downregulated in Gnpat KO mice and highlighted that many of them are involved in synaptic transmission and synaptogenesis. Furthermore, a subset of these proteins was validated using western blot and immunohistochemistry, demonstrating a dysregulation in several processes necessary for correct synaptic function. *In vitro* analysis of cortical neurons from Gnpat KO mice shows decreased synaptic densities using a battery of pre and post-synaptic components. Combined with a decrease in dendritic spine density in the cortex of the neuron-specific Gnpat mutant, our results support an essential role of plasmalogens in regulating synaptogenesis and synaptic transmission.

The alanine-serine-cysteine-transporter 1 provides glycine for inhibitory glycinergic transmission in an auditory brainstem synapse

Lina Hofmann¹, Eckhard Friauf¹

¹Technische Universität Kaiserslautern, Animal Physiology, Erwin-Schrödinger-Straße 13, 67663 Kaiserslautern, Germany

Inhibitory glycinergic transmission plays an important role in sound source localization in the auditory brainstem. Glycinergic inputs from the medial nucleus of the trapezoid body (MNTB) to the lateral superior olive (LSO) are involved in processing interaural level differences. Recycling of synaptically released glycine is crucial for reliable inhibitory transmission at MNTB LSO inputs. This is ensured by glycine transporter 2 (GlyT2), and glycine is then refilled into synaptic vesicles. Knockout (KO) of GlyT2 severely impairs transmission but does not lead to complete failure. The residual function implies another glycine source. These sources can be proteins involved in glycine syntheses or other glycine uptake systems. The alanine-serine-cysteine-1 transporter (Asc-1) has a high glycine affinity and is expressed in glycinergic synapses. Pharmacological blockade or KOs of Asc-1 showed a reduction in spontaneous glycinergic transmission in spinal cord and brainstem (Safory et al., 2015 DOI: 10.15252/embr.201439561; Mesuret et al., 2018 DOI: 10.1038/s41598-018-26868-6).

We investigate whether the residual transmission at MNTB-LSO synapses, despite the loss of GlyT2, is due to glycine provided by Asc-1. Furthermore, we tested whether Asc-1 is involved in transmission of wildtype (WT) mice. We performed whole-cell patch-clamp recordings on LSO principal neurons in acute slices from postnatal day 11 WTs and GlyT2 KOs. Inhibitory postsynaptic currents (eIPSC) were evoked via stimulation of MNTB fibers at 10 Hz, followed by a recovery period at 0.1 Hz, each for 60 s. Asc-1 was blocked by perfusion of an inhibitor (BMS-466442, 50 μ M). eIPSCs were recorded in control and drug treatment conditions.

Short-term depression (STD) was unaltered upon inhibition of Asc-1 in both WTs and KOs. eIPSC amplitudes maintained stable transmission of 50 % and were able to recover back to baseline from STD. The amplitudes and frequency of spontaneous IPSCs remained unchanged in BMS compared to the control solution. However, transmission was unaffected in WTs and KOs in BMS. To deplete preformed synaptic vesicles in KOs, we applied harsher stimulation during perfusion of BMS. Performance was 2.5 fold reduced in BMS. eIPSC amplitudes recovered to 75 % from STD in control solution but were unable to recover in BMS. In an attempt to exhaust the WT inputs, we performed 'marathon experiments' (50 Hz followed by 1 Hz recovery, each 60 s, 10 repetitions, Brill et al., 2021 DOI: 10.3389/fnsyn.2020.560008). In controls, STD remained at a constant level of 29 % throughout all 10 repetitions. eIPSC amplitudes recovered back to 100 % compared to baseline. Upon pharmacological GlyT2 blockade (ALX, 2 μ M), STD decreased to 20 % in the 10th repetition. Nevertheless, synapses recovered sufficiently. In ALX and BMS together, eIPSC amplitudes ended up at 7 % and recovered to 50 % in the 10th repetition.

Collectively, our results demonstrate that Asc-1 is involved in glycinergic transmission and is, like GlyT2, an additional glycine source and essential for the import of glycine into MNTB presynaptic terminals in both KOs and WTs.

The alternative splicing of P/Q-type calcium channels fine tunes presynaptic properties and neurotransmitter release

Ana Carolina Palmeira do Amaral¹, Abderazzaq El Khallouqi¹, Jennifer Heck², Arthur Bikbaev¹, Melanie Mark³, Stefan Herlitze⁴, Martin Heine¹

¹Johannes Gutenberg University Mainz, Institute for Developmental Biology and Neurobiology, Mainz, Germany

²European Molecular Biology Laboratory (EMBL), Genome Biology Unit, Heidelberg, Germany

³Ruhr University Bochum, Behavioral Neurobiology, Bochum, Germany

⁴Ruhr University Bochum, Department of Zoology and Neurobiology, Bochum, Germany

Many synaptic proteins undergo alternative splicing (AS) to expand their diversity and possibly to allow synapse specification. Here, we focus on presynaptic voltage-gated P/Q-type calcium ($Ca_v2.1$) channels that are essential to trigger neurotransmitter release in central synapses. Two important splice sites have been identified in the C-terminus of $Ca_v2.1$ channels. Exon 47 was shown to modulate the channel's synaptic association with scaffold proteins and exon 37 is responsible for the channel's tuning of calcium-induced facilitation. It has been previously reported that splicing of each exon alone can influence synaptic short-term plasticity. However, it remains unclear how a simultaneous AS of both exons affects the information processing within the presynaptic compartment and synaptic transmission.

To examine this, we generated Halo-tagged $Ca_v2.1$ constructs with 4 possible C-terminal combinations ([37a/+47], [37a/ Δ 47], [37b/+47], and [37b/ Δ 47]). Expression of these splice variants in hippocampal neurons from a knock-in mouse with N-terminal citrine-tagged $Ca_v2.1$ channels allowed us to evaluate the replacement of the endogenous $Ca_v2.1$ channel population by the Halo-tagged $Ca_v2.1$ channels. Furthermore, we estimated the relative number of Halo-tagged channels in the synapse as well as their mobility and confinement within the presynaptic compartment. Additionally, we assessed functional parameters such as presynaptic calcium signals and glutamate release to reveal the impact of individual splice variants on neurotransmitter release. We found that the combination of exons 37a/+47 is associated with the strongest channel's confinement, the steepest increase in calcium influx and the highest release probability. In contrast, the expression of the 37b/ Δ 47 variant resulted in the weakest confinement within the synapse and a considerably smaller calcium signal while the release probability was comparable to that of $Ca_v2.1$ (37a/+47). For both 37a/ Δ 47 and 37b/+47 variants we found a decreased release probability. These effects were similarly observed in neurons with knocked-down $Ca_v2.1$ endogenous channels therefore, their contribution can be ruled out.

Recorded calcium responses from non-transfected neurons revealed a wide-range variability between individual synapses that was reduced when individual splice variants were expressed. This suggests a heterogeneity among $Ca_v2.1$ channel population due to the expression of different splice variants within synapses. Moreover, reanalysis of an available sequencing dataset revealed different usage of exon 37 and 47 across various neuron types. Additionally, western blotting experiments on synaptosomes confirmed that $Ca_v2.1$ +47 and Δ 47 channels are expressed in synapses and their abundance changes in an age-dependent manner.

In conclusion, our work suggests that the synaptic recruitment of different C-terminal populations of Ca_v2.1 channels can enable a fine tuning of presynaptic calcium signaling and glutamate release.

The regulation and impact of microtubule abundance at the *Drosophila* neuromuscular junction.

Dario Andrea Lasser¹, Hannes Euler¹, Zeeshan Mushtaq¹, Jan Pielage¹

¹Department of Zoology-Neurobiology, TU Kaiserslautern, Kaiserslautern, Germany

Microtubules (MTs) are essential protein polymers with a far-reaching spectrum of tasks throughout neuronal development. Malfunction of MTs or of interacting proteins and regulators can lead to severe diseases like lissencephaly or progressive neurodegeneration. To identify the molecular mechanisms controlling stabilization and organization of MTs in neurons, we performed an *UAS-Gal4* mediated RNAi screen in *Drosophila melanogaster*, combined with immunohistochemical assays for neuromuscular junction (NMJ) phenotypes. In this screen, we uncovered a yet unknown role of the Ubiquitin-proteasome system (UPS) for the control of synaptic microtubule abundance.

Impairing specific steps of the UPS pathway led to a severe increase of MTs and microtubule-associated proteins like Futsch/Map1B at the NMJ. As a consequence, several growth parameters and synaptic bouton organization were perturbed at these NMJs. All phenotypes could be successfully rescued by the expression of wild type variants of affected UPS proteins in mutant animals. Our results highlight the importance of MT organization and function at the *Drosophila* NMJ and provide insights into the role of the UPS system for MT regulation. We now aim to further clarify the mechanisms involved in MT regulation via genetic interaction screens and proteomic approaches and by applying super-resolution microscopy.

The secretory pathway protein Sec31 controls composition and function of the presynaptic active zone

Marius A. Lamberty¹, Kerstin Reim², Jutta Meyer², Olaf Jahn^{2,3,4}, Robert J. Kittel¹

¹Department of Animal Physiology, Faculty of Life Sciences, Universität Leipzig, 04103 Leipzig, Germany

²Department of Molecular Neurobiology, Max Planck Institute of Multidisciplinary Sciences, 37075 Göttingen, Germany

³Neuroproteomics, Max Planck Institute of Multidisciplinary Sciences, 37075 Göttingen, Germany

⁴Translational Neuroproteomics, Department of Psychiatry and Psychotherapy, University Medical Center Göttingen, 37075 Göttingen, Germany

Information processing in the nervous system is shaped by neurotransmitter release from synaptic vesicles (SVs) at the presynaptic active zone. The cytomatrix at the active zone (CAZ) controls exocytosis by physically coupling SVs to release-sites. Correspondingly, the protein composition of the CAZ is functionally highly relevant and disrupting its molecular organization impairs synaptic transmission. However, the molecular mechanisms governing CAZ assembly are incompletely understood. The ELKS/CAST homolog Bruchpilot (Brp) is a core CAZ component in *Drosophila melanogaster*, which supports neurotransmitter release by tethering SVs and clustering voltage-gated calcium channels at the active zone. Using a short C-terminal Brp fragment as bait we found a strong enrichment of the secretory pathway protein Sec31 in affinity purification assays. Here, we further investigated this interaction by combining super-resolution microscopy and electrophysiology. Consistent with the biochemical results, Sec31 and Brp colocalize within the neuronal endoplasmic reticulum. RNA interference mediated knock-down and mosaic knock-out of *sec31* in motoneurons reduces Brp expression at neuromuscular CAZs. This is accompanied by decreased active zone levels of voltage-gated calcium channels and the priming protein Unc13A. As a result, neurotransmitter release probability drops and synaptic efficacy is reduced. We conclude that Sec31 activity influences CAZ assembly and thereby impacts presynaptic function.

Transcriptional profiling of two nuclei in the mouse auditory brainstem reveals gene sets important for auditory processing

Mirjam Montag¹, Ayse Maraslioglu-Sperber¹, Kathrin Kattler², Eckhard Friauf¹

¹TU Kaiserslautern, AG Tierphysiologie, Fachbereich Biologie, Erwin-Schrödinger Str. 13, 67663 Kaiserslautern, Germany

²Universität des Saarlandes, Fachbereich Biowissenschaften, Institut für Genetik/Epigenetik, 66041 Saarbrücken, Germany

In the mammalian auditory brainstem, the medial nucleus of the trapezoid body and the lateral superior olive (MNTB, LSO) are involved in sound source localization. MNTB neurons convert monaural excitatory and contralateral input into inhibition, whereas LSO neurons integrate binaural excitatory and inhibitory inputs (Friauf et al. 2019; DOI: 10.1093/oxfordhb/9780190849061.013.10). Each nucleus fulfils distinct functions in this convergent and integrating pathway. In both nuclei, gene expression patterns depend on age and sensory experience. We aim to extract the molecular differences and similarities between both nuclei and compare the results to functional differences and similarities. Our goal is to gain insight in the gene products that enable MNTB and LSO to perform their specific tasks.

Therefore, we generated whole transcriptome profiles by sequencing RNA of MNTB and LSO tissue isolated via laser capture microdissection at three ages (pre-hearing, hearing onset (P12), young adult. Here we focus on P12) (Nichterwitz et al. 2016; DOI: 10.1038/ncomms12139). At each age, we analysed ≥ 3 biological replicates. To assess auditory brainstem-specific transcripts involved in the robust and highly precise transmission of signals in MNTB and LSO neurons, we compared both auditory nuclei with the trigeminal motor nucleus (Mo5), a non-auditory brainstem nucleus.

Principal component analysis revealed that global gene expression patterns were clustered by age and nucleus. More than 16,000 transcripts were identified, in the P12 data set for the comparisons MNTB-vs-LSO and MNTB&LSO-vs-Mo5. Differentially expressed gene (DEG) analysis showed distinct transcripts for MNTB and LSO at all ages. Comparing LSO-vs-MNTB at P12, 466 DEGs were found in the LSO and 156 DEGs in MNTB. Top-ranked DEGs included known markers for LSO and MNTB, like *VGluT2* and *Calb1*, respectively. Our analysis also revealed expression of novel genes e.g., *Cea10* and *Cryaa* in LSO and *Doc2g* and *Kcnmb2* in MNTB. Marker genes were obtained from pairwise comparisons between LSO, MNTB and Mo5. Gene ontology (GO) analysis for MNTB marker genes revealed DEGs involved in “potassium ion transport”. A deeper look into these genes revealed different subsets and members of K⁺ channels. Some of these channels or transporters were described earlier in MNTB (*Kir2.3*, *Kcc4*), thus validating our data, yet novel candidates were also identified (*Kcnmb2*, *Kcnmb4*). Conserved genes, which are DEGs expressed throughout development, for MNTB reflected these findings, as they included known genes for several ion channels and neurotransmitter transport. In the LSO, conserved genes were mostly transcription factors with different downstream targets in neuronal cells. These were represented by the GO-term “positive regulation of neuron differentiation”.

Taken together, our study shows high numbers of DEGs, from all ages, for MNTB (\varnothing 187) and LSO (\varnothing 370), including transcripts relevant for neuronal signalling, membrane potential and neuron development. On the other hand, MNTB and LSO share a high number of expressed genes known in auditory processing, in comparison to Mo5 (\varnothing 262). The results emphasize that the distinct physiological functions of these two auditory brainstem nuclei in sound localization are mirrored on the transcript level.

Understanding the synaptic basis of dystonia pathogenesis triggered by RIMBP1 mutations

Chiara Olmeo¹, Joaquin Campos¹, Niccolò Mencacci², Claudio Acuna¹

¹University of Heidelberg , Institut for Anatomy and Cell Biology , Im Neuenheimer Feld 307, 69120 Heidelberg , Germany

²Department of Neurology, Northwestern University, USA

Dystonia is a debilitating movement disorder characterized by abnormal movements and postures. After Parkinson's disease and essential tremor, dystonia is the third most common movement disorder but the precise cellular and molecular events responsible for its genesis are not yet understood. Given the absence of structural lesions in the brain of most dystonic patients, disruption of synaptic function has been long hypothesized to play a pivotal role in dystonia pathogenesis. Indeed, we recently identified homozygous frameshift, nonsense, and missense variants in *TSPOAP1*, the gene encoding active zone RIM-binding protein 1 (RIMBP1), as a novel genetic cause of autosomal recessive dystonia (Mencacci et al., JCI, 2021), RIMBP1 is a presynaptic protein that localizes voltage-gated Ca²⁺ channels (VGCCs) and Ca²⁺ activated potassium channels (BKs) to the active zone, ensuring tight coupling between presynaptic spikes and vesicle exocytosis. How RIMBP1 pathogenic variants impact synaptic transmission and cause dystonia is unknown. To address this question, we first reprogrammed fibroblasts from patients with dystonia carrying bi-allelic *TSPOAP1* homozygous variants into induced pluripotent stem-cells (iPSCs), and then used CRISPR/Cas9 homology-directed repair technology to correct these variants, generating isogenic control lines. Then, we derived isogenic mutant and control iPSCs into functional neurons using forced expression of Ngn2, and assessed in detail their morphology and function using advanced microscopy, micro-electrode array technology, patch clamp electrophysiology, and calcium imaging. Using this approach, we are studying synaptic abnormalities triggered by all currently described dystonia-causing *TSPOAP1* variants. Our immediate goal is to define convergent pathogenic mechanisms that affect presynaptic function to contribute to dystonia pathogenesis. In the near future, we will also attempt to correct these synaptic abnormalities using genetic and/or pharmacological approaches, which we hope can be eventually used to treat patient with dystonia based on RIMBP1 dysfunction.

Poster Topic

T8: Synaptic Plasticity, LTP, LTD

- [T8-1A](#) A biophysical model for synaptic tagging
Michael Fauth, Francesco Negri, Christian Tetzlaff
- [T8-2A](#) Activity-dependent changes of the synaptic nanoarchitecture revealed by STED microscopy
Katrin Ina Willig, Valérie Clavet-Fournier, Waja Wegner
- [T8-3A](#) All-optical interrogation of Schaffer collaterals synapses *in vivo*
Cynthia Rais, J. Simon Wiegert
- [T8-4A](#) All-optical investigation of long-term plasticity in the hippocampus.
Rui Wang, Margarita Anisimova, Michaela Schweizer, Thomas G Oertner, Christine E Gee
- [T8-5A](#) Analysing the synaptic plasticity in the progressive phenotype of murine tauopathy
Jennifer Just, S. Ludewig, C. Bold, D. Baltissen, U. Müller, M. Korte
- [T8-6A](#) Calcium mediated presynaptic homeostatic plasticity at the *Drosophila* NMJ
Lea Deneke, Jashar Arian, Niklas Krick, Carsten Duch
- [T8-7A](#) Cell-autonomous cAMP signaling is not a plasticity and immediate early gene expression trigger at Schaffer collateral synapses
Oana-Maria Constantin, Daniel Udvari, Paul Lamothe-Molina, Lennart Beck, Christine Gee, Thomas Oertner
- [T8-8A](#) C-terminal Binding Protein 1 (CtBP1) regulates synaptic plasticity and energy metabolism in hippocampus
Enes Yagiz Akdas
- [T8-1B](#)
GABAergic regulation of timing-dependent LTP in mouse CA1 pyramidal neurons along the longitudinal axis of the hippocampus
Babak Khodaie, Elke Edelmann, Volkmar Leßmann
- [T8-2B](#) *Drosophila* Rab3 mediates cyclic AMP-dependent presynaptic plasticity
Divya Sachidanandan, Aishwarya Aravamudhan, Isabella Maiellaro, Stefan Hallermann, Robert J. Kittel

- [T8-3B](#) Elucidating the role of STIM proteins in mediating PM-ER contacts and their role in synaptic plasticity and synaptic architecture
Arun Chhikara, Filip Maciag, Karin Ruban, Martin Heine, Kay Grünewald
- [T8-4B](#) Environmental enrichment increases sparse coding in adult hippocampus
Ekaterina Verdiyana, Meredith Lodge, Jan Michael Schulz, Josef Bischofberger
- [T8-5B](#) Fully-primed slowly-recovering vesicles mediate LTP at neocortical neurons
Jana Nerlich, Iron Weichard, Holger Taschenberger, Grit Bornschein, Andreas Ritzau-Jost, Hartmut Schmidt, Robert J. Kittel, Jens Eilers, Erwin Neher, Stefan Hallermann
- [T8-6B](#) Homeostatic synaptic plasticity recruits coordinated structural and functional changes in superficial pyramidal neurons of the human neocortex
Maximilian Lenz, Pia Kruse, Amelie Eichler, Phyllis Stöhr, Jakob Straehle, Paul Turko, Imre Vida, Jürgen Beck, Andreas Vlachos
- [T8-7B](#) Homeostatic synaptic plasticity rescues neural coding reliability
Nadine Ehmman, Eyal Rozenfeld, Julia E. Maniom, Robert J. Kittel, Moshe Parnas
- [T8-1C](#) Inactivity induced homeostatic synaptic plasticity requires ECM remodeling
Bartomeu Perello Amoros, Fabian Zmiskol, Rahul Kaushik, Constanze Seidenbecher, Alexander Dityatev, Renato Frischknecht
- [T8-2C](#) Intermittent theta burst repetitive transcranial magnetic stimulation (rTMS) induces excitatory synaptic plasticity in human neocortical slices
Christos Galanis, Jakob Straehle, Elli Anna Balta, Dieter Henrik Heiland, Jürgen Beck, Andreas Vlachos
- [T8-3C](#) Light-induced ultrastructural synaptic plasticity in the mushroom body calyces of honeybees using STEM tomography
Nadine Kraft, Christian Stigloher, Wolfgang Rössler, Claudia Groh
- [T8-4C](#) Longitudinal imaging of individual hippocampal synaptic sub-groups
Alessandro Francesco Ulivi, Hannah Klimmt, Bhargavi K.B. Murthy, Rosa Eva Huettl, Jinhyun Kim, Alon Chen, Stefan Remy, Alessio Attardo
- [T8-5C](#) LTP-induced dynamics of actin and spine geometry
Mitha Thomas, Michael Fauth
- [T8-6C](#) Optogenetic activation of mGluR1 signaling induces synaptic plasticity in Purkinje cells
Lennard Rohr, Tatjana Surdin, Bianca Preissing
- [T8-7C](#) The molecular communication between synapses influences synaptic plasticity
Shirin Shafiee, Christian Tetzlaff

A biophysical model for synaptic tagging

Michael Fauth¹, Francesco Negri¹, Christian Tetzlaff²

¹Georg-August University Göttingen, 3rd Institute for Physics, Friedrich Hund Platz 1, 37077 Göttingen, Germany

²University Medical Center, Göttingen, Institute for Neuro- and Sensory Physiology, Von-Siebold-Str. 3a, 37075 Göttingen, Germany

Dendritic spines form the morphological basis of most excitatory synapses. During synaptic plasticity, these structures undergo remodelling of their shape (structural plasticity) and their receptor content (functional plasticity).

These alterations typically have a quickly decaying early phase and a late phase, which only emerges when (i) a so-called synaptic tag is set at the specific synapse and (ii) the synapse captures newly synthesized plasticity related proteins. This mechanism has so far been mostly modeled phenomenologically, such that models could not be readily mapped to biology.

Here, we present a simple model capturing the complex biophysical processes that give rise to late-phase plasticity. Particularly, we consider the dynamics of cytoskeletal actin filaments in the spine, which occur in two distinct pools: a dynamic one with a fast molecule turnover rate, and a more static one, in which filaments are stabilized by cross-linking proteins. During plasticity, there are various phases in which the dynamics of actin filaments is modulated, for example through crosslinker unbinding. As a result the spine can undergo dramatic changes in volume and the postsynaptic density hosting the receptors can undergo size changes, which ultimately lead to changes in the receptor content and thus functional LTP or LTD.

Using a coarse grained approach we reduced these complex interactions to three fundamental biological variables of spine dynamics: the two actin pools and the PSD size, which serves as a proxy for the synaptic transmission efficacy. Their dynamics is captured by simple differential equations, which are temporally modulated during plasticity according to experimental observations.

When analyzing this model, we find that it can reproduce not only standard plasticity events like LTP and LTD, but also a number of experimental findings associated with the STC mechanism -- from conversion of early-LTP into late-LTP, to the transient property of the synaptic tag, and also more complex mechanisms such as tag resetting through the use of low frequency stimuli after strong tetanization.

Hence, we present the first biophysically interpretable model for synaptic tagging and capture that, on the one hand, can reproduce various experiments on functional plasticity and, on the other hand, is simple enough to be analyzed analytically and used in network simulation.

Activity-dependent changes of the synaptic nanoarchitecture revealed by STED microscopy

Katrin Ina Willig¹, Valérie Clavet-Fournier¹, Waja Wegner¹

¹Max Planck Institute for Multidisciplinary Sciences, Group of Optical Nanoscopy in Neuroscience, Hermann-Rein-Str. 3, 37075 Göttingen, Germany

Synaptic plasticity is at the center of the formation, storage and retrieval of memory, and the emergence of cognitive functions in neuronal networks. Several lines of evidence suggest a tight link between synaptic strength and the morphology of the synapse and associated dendritic spines. Recently, it was shown that synaptic proteins are often assembled in a complex nanopattern and that pre- and post-synaptic elements are aligned in the so-called nanocolumns. A detailed assessment of the nanoplasticity of these structures in the living environment, however, requires super-resolution light microscopy techniques. We utilize STED microscopy, a super-resolution microscopy technique suitable for imaging of living tissue and mouse cortex *in vivo* with a resolution below the diffraction-limit of light microscopy to study activity-dependent changes of the post-synaptic scaffolding protein PSD95 and the spine morphology. We employ environmental enrichment where a mouse is provided with multi-sensory stimulation, cognitive activity, social interactions, and physical exercise, which is associated with increased activity. We were able to map temporal changes *in vivo* and showed that mice, which were housed under such enhanced activity settings display a sharper size distribution of spine heads and PSD95 nanoorganization. The pattern of the PSD95 nanoorganization was more dynamic after environmental enrichment, but the changes in size were smaller than in mice housed in standard cages. These results demonstrate that experience influences the synaptic nanopattern and its plasticity.

In parallel, we studied the remodeling of the PSD95 nanoorganization in living organotypic hippocampal brain slices after induction of long-term potentiation (LTP). This enabled us to track the transformation of the PSD95 nanoorganization over the persistent strengthening of the synapse. We found that the size of the PSD95 nanoorganization increases with a delay of ~1 h after LTP induction, which indicates a temporal imbalance between changes of the spine head and synaptic organization. The size increase is accompanied by a more complex patterning of the PSD95 nanoorganization; LTP stimulation increases the percentage of perforated or segmented PSD95 assemblies significantly. These results suggest that the structural plasticity of PSD95 is an important feature involved in the adaptation of the synaptic strength.

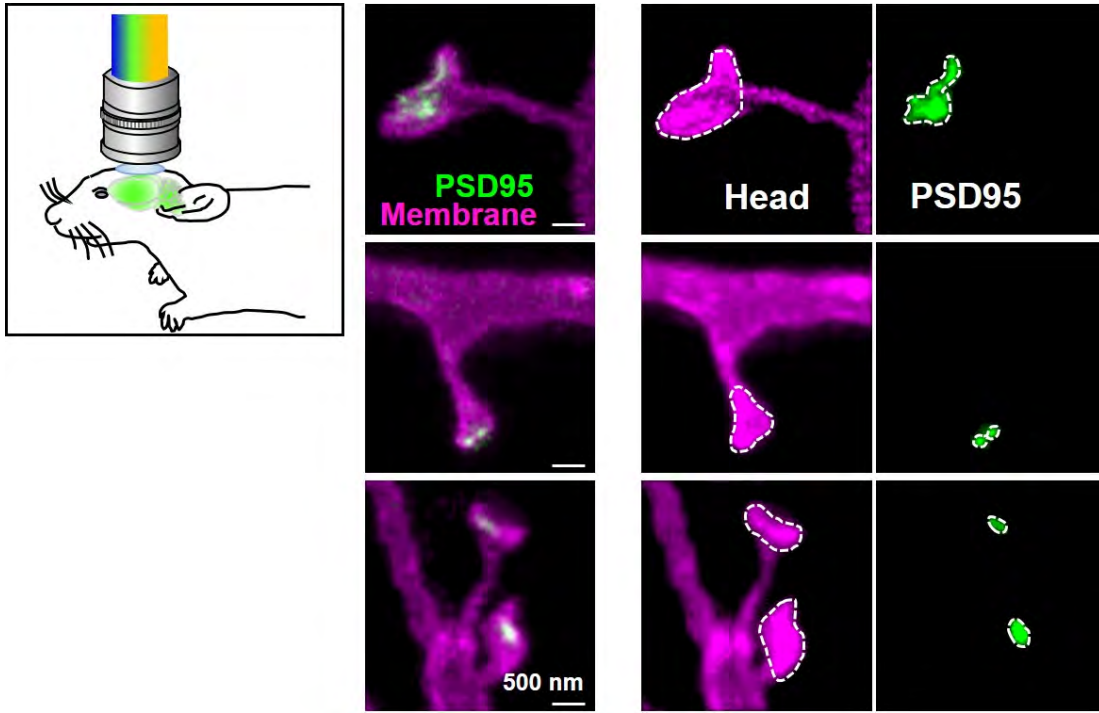

In vivo STED microscopy of PSD95 and the spine morphology

All-optical interrogation of Schaffer collaterals synapses *in vivo*

Cynthia Rais¹, J. Simon Wiegert^{1,2}

¹Center for Molecular Neurobiology Hamburg (ZMNH) - UKE, Synaptic Wiring and Information Processing, Falkenried 94, 20251 Hamburg, Germany

²Medical Faculty Mannheim - Heidelberg University, Neurophysiology, Ludolf-Krehl-Straße 13-17, 68167 Mannheim, Germany

The hippocampus encodes information about an animal's position in space, integrating internal representations about the environment with sensory inputs, including tactile, auditory and visual stimuli. Most prominently, spatial information is encoded in CA1 place cells. However, while spatial memories can be retained over long time periods, place cell ensembles reorganize over days. While the cellular dynamics of hippocampal coding are well-described, less is known about functional and structural dynamics of individual Schaffer collateral synapses. There is no consensus with regard to the stability of synapses over time. While some studies suggest high turnover of spines, others found high stability. Moreover, a link between synaptic function and structural plasticity is missing. While shown *in vitro* that spine survival is influenced by functional plasticity, it is not known to what extent this link between synapse stability and activity *in vivo* is preserved. Thus, to better understand how dynamic remapping of cellular ensembles is related to synapse dynamics, we need to establish a link between functional and structural synaptic plasticity *in vivo*. In this study, we chronically imaged dendritic spines on CA1 cells in the awake mouse, monitoring their synaptic responses by optogenetically stimulating presynaptic CA3 cells. Using this approach, we were able to induce local, synaptic calcium responses at individual spines and to assess the stability of these functionally identified synapses over a time period of two weeks.

All-optical investigation of long-term plasticity in the hippocampus.

Rui Wang¹, Margarita Anisimova¹, Michaela Schweizer², Thomas G Oertner¹, Christine E Gee¹

¹Institute for Synaptic Physiology, Center for Molecular Neurobiology Hamburg, University Medical Center Hamburg-Eppendorf, Hamburg, Germany

²Core Facility Morphology and Electron Microscopy, Center for Molecular Neurobiology Hamburg, University Medical Center Hamburg-Eppendorf, Hamburg, Germany

Synaptic plasticity, inducing long-lasting changes in synaptic efficacy and structure, is a major mechanism of information storage in the brain. Such dynamic modulation of synaptic strength is realized by a multitude of signaling pathways. We took advantage of optogenetic tools to induce synaptic plasticity and manipulate specific signaling pathways at the same time. We induced spike-timing-dependent plasticity (STDP) at Schaffer collateral synapses in rat hippocampal slice culture by optogenetic stimulation of two neuronal populations expressing spectrally separated channelrhodopsins. We found that optically induced timing-dependent long-term potentiation (tLTP) facilitates synaptic strength minutes to hours after stimulation. Even 3 days later, we could detect strengthened synaptic input onto tLTP neurons.

Calcium–calmodulin-dependent protein kinase II (CaMKII) is one of the most important memory molecules that transform transient synaptic activity events into long-lasting synaptic plasticity through its autophosphorylation feature. Whether CaMKII is essential to induce and/or maintain synaptic plasticity is yet unanswered. When we optically inhibited the activity of CaMKII α , a complete blockade of the acute LTP was observed. Unexpectedly, 3 days later, stimulated neurons received significantly stronger input than their neighbors, a delayed potentiation that appears to be independent of CaMKII α activity. We then tested the direct effects of CaMKII α activation with a photoactivatable CaMKII. We found that optical activation of CaMKII α is sufficient for inducing acute functional and structural LTP as well as immediate early gene expression through a cellular communication-independent manner. By combining the optogenetic tools with an enhanced ascorbate peroxidase-based genetic tag, we also observed the acute spine morphology alteration on the ultrastructural level. However, this CaMKII α -activation-induced LTP returns to baseline after a couple of days. Together, these data suggest that activity-dependent potentiation of synaptic inputs has two phases: CaMKII α is necessary and sufficient for the induction of early LTP. A second, CaMKII α independent mechanism is responsible for the selective strengthening of inputs days later.

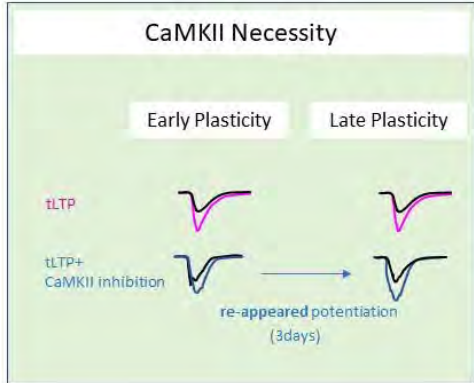
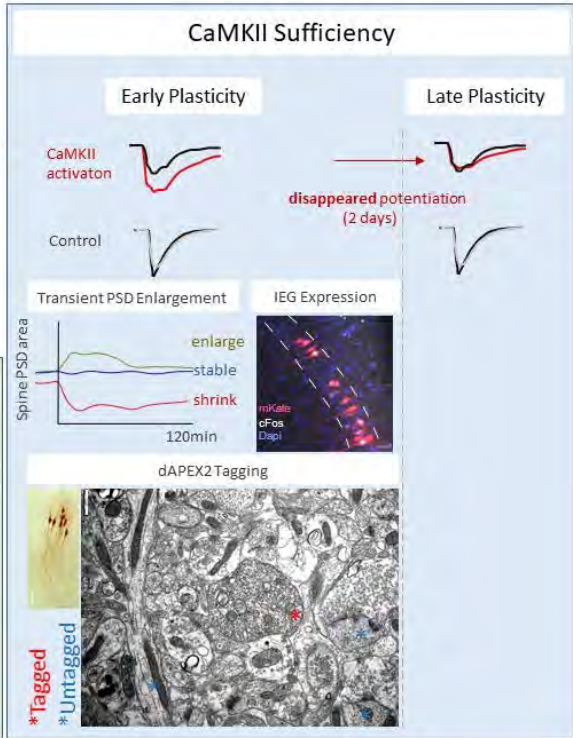
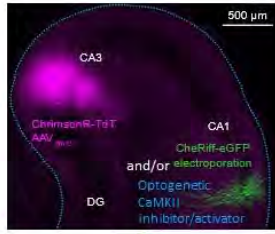

Analysing the synaptic plasticity in the progressive phenotype of murine tauopathy

Jennifer Just¹, S. Ludewig^{1,2}, C. Bold³, D. Baltissen³, U. Müller³, M. Korte^{1,2}

¹Division of Cellular Neurobiology, Zoological Institute, TU Braunschweig, Germany; ²Helmholtz Centre for Infection Research, Neuroinflammation and Neurodegeneration Group, Germany; ³Institute for Pharmacy and Molecular Biotechnology, University of Heidelberg, Germany

Alzheimer's disease (AD) is a common neurodegenerative disease in the aging population. One of its major histopathological hallmarks, in addition to A β plaques, is the hyperphosphorylation of the Tau protein, which later on accumulates and forms neurofibrillary tangles (NFTs). Focusing on this tauopathy, we used the transgenic mouse model hTau.P301S and could demonstrate a progressive phenotype in hippocampal synaptic plasticity, including an aberrant long-term potentiation (LTP) and reduced basal synaptic transmission after stimulation at the Schaffer collaterals in aged mice, while the long-term depression (LTD) was unaltered at the investigated ages (10-13/16-18 weeks).

Previously, we could demonstrate the neuroprotective effect of the neurotrophic peptide APPs α , which is produced by the processing of the Amyloid precursor protein (APP) via α -secretases in the non-amyloidogenic pathway. In contrast to the neurodegenerative effect of A β ; accumulation, the APPs α ; molecule was shown to rescue phenotypes of various AD pathology models. In our approach the treatment of P301S hippocampal acute slices with a nanomolar concentration of recombinant APPs α ; (recAPPs α) was able to restore the increased LTP to control level. To further investigate the altered synaptic plasticity in the P301S mouse model and its possibly missing inhibitory input, which is also supported by the observed loss of interneurons, we used the γ -aminobutyric acid type A receptor (GABA_AR) agonists muscimol and zolpidem before stimulation. Additionally, we applied recAPPs α ; to wild-type acute slices to support the hypothesis of a neuro- and synaptoprotective effect of APPs α ;

Taken together, we demonstrate the potential of APPs α ; as a therapeutic for tauopathies, in addition to its previously shown positive effect on A β -dependent AD phenotypes, as well as the disturbed neuronal circuits resulting in altered synaptic plasticity in the hTau.P301S model (supported by the DFG, MU1457/14-1; KO 1674/28-1 to MK).

Calcium mediated presynaptic homeostatic plasticity at the *Drosophila* NMJ

Lea Deneke¹, Jashar Arian¹, Niklas Krick², Carsten Duch¹

¹Johannes Gutenberg-University of Mainz, Institute of Developmental Biology and Neurobiology, Hanns-Dieter-Hüsch-Weg 15, 55128 Mainz, Germany

² University of Cambridge, Department of Zoology, Downing Street, CB2 3EY Cambridge, United Kingdom

At the presynaptic terminal of chemical synapses numerous calcium-dependent processes like synaptic vesicle (SV) release, SV recycling and adaptive as well as homeostatic synaptic plasticity occur side by side and must be dynamically adapted to ensure synapse function. These mechanisms operate in parallel but have different though partially overlapping spatial and temporal requirements.

We recently showed that at the *Drosophila* NMJ, an established model for glutamatergic synapse function, a separate regulation of different Ca²⁺-dependent processes is achieved through division of labor between two voltage-gated calcium channels (VGCCs). The Ca_v2 homolog cacophony localizes to active zones and mediates evoked SV release, while the Ca_v1 homolog DmCa1D localizes outside active zones and augments SV recycling and short-term plasticity. The calcium extrusion pump PMCA isolates these functions and ensures stable release probability by protecting the active zone from other presynaptic calcium signals (Krick et al., PNAS, 2021).

In order to counter destabilizing perturbations and stabilize synaptic transmission, perturbations of synaptic strength are precisely compensated for by homeostatic plasticity. At the *Drosophila* NMJ presynaptic homeostatic plasticity (PHP) includes mechanisms that adjust the release probability and is temporally and functionally separated into an initiation and maintenance phase.

We show that Ca_v1 and PMCA are crucial for the initiation of PHP. The activity of PMCA regulates the functional coupling distance of Ca_v1 channels to SVs and thus also determines the impact of Ca_v1 mediated Ca²⁺ influx on synaptic transmission. However, to maintain PHP, Ca²⁺-signaling must outlast VGCC-mediated Ca²⁺-signals. Combining *Drosophila* genetics, electrophysiology and imaging techniques we are currently investigating whether signaling downstream of Ca_v1 and PMCA is necessary for the PHP maintenance phase. Here we focus on the role of interactions with ER Ca²⁺-signaling and the regulation of plasma membrane ER interactions. Tuning of both store operated calcium entry (SOCE) via STIM-Orai channels and calcium induced calcium release (CICR) via RyR activation may play a crucial role in the maintenance of increased release probability via increased intracellular Ca²⁺ and restore the adaptive potential of PMCA and Ca_v1 to compensate for additional future perturbations.

Cell-autonomous cAMP signaling is not a plasticity and immediate early gene expression trigger at Schaffer collateral synapses

Oana-Maria Constantin¹, Daniel Udvari¹, Paul Lamothe-Molina¹, Lennart Beck¹, Christine Gee¹, Thomas Oertner¹

¹Zentrum für Molekulare Neurobiologie Hamburg (ZMNH), Institute for Synaptic Physiology, Falkenried 94, 20251 Hamburg, Germany

Cyclic adenosine monophosphate (cAMP) is a ubiquitous second messenger that, when raised by forskolin, usually together with picrotoxin and rolipram to block GABA_A and phosphodiesterases, induces long-term potentiation (LTP) of synaptic transmission and expression of immediate early genes such as FOS by activating the postsynaptic PKA-CREB pathway. However, most studies of neuronal cAMP have relied on pharmacological tools whose actions are not confined to specific cells or synaptic compartments. Here, we take advantage of recent developments in photoactivatable adenylyl cyclases to raise cAMP in single postsynaptic hippocampal CA1 neurons, in many presynaptic CA3 neurons, many postsynaptic CA1 neurons or in all excitatory neurons to investigate cell-autonomous and synaptic compartment-specific effects of cAMP at Schaffer collateral synapses.

Surprisingly, optogenetically raising cAMP in single postsynaptic CA1 neurons induced neither LTP nor FOS expression despite PKA activation. However, similarly to the effects of forskolin, optogenetically increasing cAMP in excitatory neurons throughout the whole hippocampal slice did induce LTP and strong FOS expression. Interestingly, raising cAMP in only presynaptic or only postsynaptic neurons induced weaker LTP in comparison to raising cAMP in neurons throughout the whole slice, while increasing the intensity of FOS labeling to similar levels as when cAMP is stimulated throughout the whole hippocampal slice. Furthermore, blocking the activity of typical cAMP downstream effectors such as PKA, EPAC and HCN channels only partially reduced the intensity of FOS labeling.

In conclusion, in contrast to current models of intracellular signaling cascades, there is no direct pathway leading from cAMP to FOS induction in individual neurons not to LTP. Rather cAMP increases excitability and transmitter release and these are required for FOS and LTP. The function of neuronal cAMP as a plasticity trigger thus requires an intact, synaptically connected network.

C-terminal Binding Protein 1 (CtBP1) regulates synaptic plasticity and energy metabolism in hippocampus

Enes Yagiz Akdas¹

¹Department of Psychiatry and Psychotherapy, Universitätsklinikum Erlangen, Friedrich-Alexander Universität Erlangen-Nürnberg, Erlangen, Germany

C-terminal Binding Protein 1 (CtBP1) is a ubiquitously expressed, metabolic status- and neuronal activity-dependent transcriptional co-repressor protein that shuttles between the nucleus and the presynapse in neurons. CtBP1 regulates synaptic plasticity- and neurodevelopment-associated genes in the nucleus. In conditions of high neuronal activity, it shuttles to the presynapse, where it regulates synaptic vesicle recycling and maintains neuronal transmission. The de novo C991T human mutation in CtBP1 gene was previously linked to decreased mitochondrial respiratory chain activities in skeletal muscles indicating its role via the regulation of energy metabolism. This function of CtBP1 has not been addressed in brain. To elucidate the role of CtBP1 in the resistance to cellular energetic stress, we performed extracellular fEPSP recordings and molecular characterization of energy metabolism in the Schaffer collaterals to CA1 region of hippocampus in CtBP1 knock-out mice. fEPSP recordings revealed impaired LTP and increased sensitivity to metabolic stresses induced by 2-DG or oligomycin. Interestingly, we detected a differential effect of glycolytic and mitochondrial deprivation on paired-pulse ratio, indicating CtBP1-linked impairment of presynaptic mechanisms during metabolic stress. The Seahorse analyses showed that loss of CtBP1 decreases glycolysis and OXPHOS rates in the hippocampal tissue, which was connected with a downregulation of glycolytic genes and abnormal expression of mitochondria-linked genes. Taken together, we demonstrate that CtBP1 provides resilience to cellular stress in the hippocampus via regulation of cellular energy metabolism. Our future aim is to dissect the specific neuronal-cell type contribution to this phenotype using cell type specific conditional CtBP1 KO model.

GABAergic regulation of timing-dependent LTP in mouse CA1 pyramidal neurons along the longitudinal axis of the hippocampus

Babak Khodaie^{1,3}, Elke Edelmann^{1,2,3}, Volkmar Leßmann^{1,2,3}

¹ Institute of Physiology, Otto-von-Guericke University Magdeburg

² Center for Behavioral Brain Sciences (CBBS), Magdeburg

³ OVGU ESF-funded International Graduate School ABINEP, 39120, Magdeburg, Germany

The hippocampus and its associated medial temporal lobe structures develop as a complex micro-network of excitatory and inhibitory synapses to process learning and memory formation. Despite previous concepts, which considered the hippocampus as a homogenous structure, recent studies revealed a genetical, morphological and functional diversity along the dorso-ventral axis of the hippocampus. The longitudinal hippocampal axis are differentially involved in spatial and emotional learning. Along this axis GABA, glutamate, and neuromodulatory receptors are differentially expressed, providing diverse synaptic regulation mechanisms. GABAergic inhibition balances excitatory responses and neuromodulatory transmitter release. Due to the non-uniform expression of GABA_A and GABA_B receptors along the longitudinal axis synaptic plasticity might be differently modulated by this diverse GABAergic inhibition.

Spike timing-dependent plasticity (STDP, a technique based on precise timing of action potentials in pre- and postsynaptic neurons) protocols (e.g., canonical (1:1) and burst t-LTP protocols (1:4) repeated for 6 times at 0.5 Hz used in an acute hippocampal slice taken from dorsal (DH), intermediate (IH) or ventral (VH) hippocampus to test timing-dependent LTP (t-LTP) induction under diverse GABAergic modulation. To test GABAergic signaling regulation of t-LTP induction, we used either intact GABAergic inhibition (physiological condition) or fully blocked inhibition using co-applied GABA_A (picrotoxin; 100 µM) and GABA_BR blocker (CGP 55845 hydrochloride; 10 µM), added to recording ACSF or a single application of a GABA_AR blocker.

Our results indicate that, basal electrophysiological and firing properties of CA1 PCs differ along the dorso-ventral axis, showing a more negative resting membrane potential in dorsal CA1 PCs compared to VH and IH, as well as higher glutamate release probability in VH CA1 PCs compared to DH. This followed by a more robust t-LTP induced by the 6x 1:1 t-LTP paradigm in PCs of the DH in the presence of only picrotoxin. Moreover, we found a complex association of excitatory and inhibitory responses depending on stimulation protocols (canonical or burst) and studied regions (DH or VH). While the 6x 1:1 protocol lost its dependency on GABAergic signaling to induce robust t-LTP from DH to VH pole, our 6x 1:4 protocol mainly depended on active GABA_BR signaling during t-LTP induction.

***Drosophila* Rab3 mediates cyclic AMP-dependent presynaptic plasticity**

Divya Sachidanandan¹, Aishwarya Aravamudhan¹, Isabella Maiellaro², Stefan Hallermann³, Robert J. Kittel¹

¹Department of Animal Physiology, Faculty of Life Sciences, Leipzig University, 04103 Leipzig, Germany

²School of Life Sciences, University of Nottingham Medical School, Queen's Medical Centre, Nottingham NG7 2UH

³Carl-Ludwig Institute of Physiology, Leipzig University, 04103 Leipzig, Germany

The molecular and cellular mechanisms underlying presynaptic plasticity are in general poorly understood. Much attention has been paid to the second messenger cyclic AMP (cAMP) as early work in *Aplysia* and *Drosophila* uncovered the importance of cAMP-dependent forms of presynaptic modulation for learning and memory processes. Studies at both invertebrate and vertebrate synapses have revealed some of the pathways through which cAMP modifies functional properties of the active zone (AZ), the presynaptic site of neurotransmitter release. Despite intense efforts, however, fundamental questions regarding the molecular mechanisms of cAMP-mediated presynaptic plasticity remain unanswered. Here we show that the small GTPase Rab3 is required for cAMP-dependent synaptic plasticity. We performed electrophysiological recordings at the glutamatergic *Drosophila* neuromuscular junction (NMJ) while manipulating cAMP levels via pharmacological means and optogenetic tools. Whereas the frequency of spontaneous synaptic vesicle fusion (minis) increased with elevated cAMP concentrations, action potential-evoked neurotransmitter release displayed more complex dynamics. By utilizing different variants of the photoactivated adenylyl-cyclase bPAC, we found that increasing cAMP levels triggers an initial facilitation of evoked release followed by pronounced presynaptic depression. Strikingly, elevating cAMP concentrations neither changed the mini frequency nor evoked neurotransmitter release in rab3 null mutants. Our results uncover an essential role of Rab3 in translating presynaptic cAMP dynamics into changes in synaptic vesicle exocytosis at the AZ. Thereby, this study helps to fill the gaps in our understanding of the molecular mechanisms underlying a classic form of synaptic plasticity.

Elucidating the role of STIM proteins in mediating PM-ER contacts and their role in synaptic plasticity and synaptic architecture

Arun Chhikara¹, Filip Maciag¹, Karin Ruban², Martin Heine¹, Kay Grünewald²

¹Johannes-Gutenberg-Universität Mainz, Institut für Entwicklungsbiologie und Neurobiologie (IDN), Hanns-Dieter-Hüsch-Weg 15, 55128 Mainz, Germany

²University of Hamburg, Center for Structural Systems Biology (CSSB), Notkestraße 85, Building 15 D-22607 Hamburg, Germany

The presence of endoplasmic reticulum (ER) - plasma membrane (PM) junctions (ER PM junctions) enables ER and PM proteins to interact directly. These junctions perform vital functions like store-operated Ca²⁺ entry (SOCE) and lipid transfer. The functional and structural roles of proteins present in neuronal ER-PM junctions are not well understood. One of these proteins are STIMs (Stromal Interaction Molecule), sensors of Ca²⁺ in the ER that activate in response to a drop in ER Ca²⁺ concentration. Activated STIMs open CRAC and TRPC channels in the PM to allow Ca²⁺ influx from the extracellular space and contribute to intracellular calcium homeostasis. Accumulating evidence suggests essential functions of STIMs in neuronal physiology, e.g., in neurotransmitter release, spine maintenance and synaptic plasticity.

We aim to understand the role of STIMs in regulating the activity-dependent structural architecture at the ER-PM junctions using TIRF microscopy. We perform single-particle tracking experiments to uncover individual STIM molecules' organization with a high temporal and spatial resolution. Our data indicate differential mobility for STIM1 and STIM2 in different neuronal compartments. Diffusion kinetics of both STIM1 and STIM2 in dendrites changes in response to upscaling and downscaling of neuronal activity, while axonal STIMs show less to no changes in their dynamics.

We hypothesize an interplay of STIMs with non-conducting Kv2.1 channels that perform a structural role in forming a type of ER-PM junction. Neurons expressing large Kv2.1 clusters often express less STIM2 and vice versa. Application of glutamate that causes de-clustering of non-conducting KV2.1 promotes clustering of STIMs at ER-PM junctions even more robustly than ER store depletion by thapsigargin. This effect seems to depend on the C-terminal polybasic domain of STIMs and its binding to PM. Temperature is a critical factor that impacts the spatial organization of Kv2.1 and STIM proteins: Kv2.1 clusters are absent at room temperature. At the same time, STIMs localization is more confined at 24°C compared with 37°C.

To assess the impact of STIM molecules on the functional properties of neurons, we perform Ca²⁺ and glutamate imaging on hippocampal cultures from STIM1 and STIM2 Cre-LoxP mice. Knocking down STIM2, the dominant isoform in the murine hippocampus, had little impact on glutamate release and cytosolic Ca²⁺ signals. However, activity-dependent uptake of Ca²⁺ to the ER was significantly increased in STIM2 KD neurons, confirming their impact on the regulation of intracellular calcium homeostasis. Our current experiments focus on identifying STIMs' partners on the PM and possibly ER responsible for this effect.

Environmental enrichment increases sparse coding in adult hippocampus

Ekaterina Verdiyan¹, Meredith Lodge¹, Jan Michael Schulz¹, Josef Bischofberger¹

¹University of Basel, Department of Biomedicine, Pestalozzistrasse, 4056 Basel, Switzerland

Sparse activity and sparse coding in dentate gyrus (DG) of the hippocampus has been considered to play a key role in memory processing. Environmental enrichment, which includes larger housing and the presence of enrichment toys and running wheels, has been shown to improve hippocampus-dependent spatial learning and memory. However, how different housing conditions influence hippocampal network activity remains still largely unclear. Here we used cFos labeling to study the effect of prolonged environmental enrichment onto hippocampal network activity during exploration of a novel environment. First, we showed that exploration leads to increased activity in DG and CA1 in animals housed under both standard and enrichment conditions. However, cFos activity during exploration was lower in enriched animals in both, granule cells and CA1 pyramidal cells. Remarkably, the number of cFos-labeled cell assemblies in home cage was even more strongly decreased with enriched housing. This indicates that continuous enrichment does not increase overall hippocampal activity but improves sparse coding in DG as well as in CA1. To understand the underlying mechanisms, we explored the possibilities that inhibitory interneurons are involved. Previous data indicate that interneurons contribute to sparse coding partially via $\alpha 5$ -subunit-containing GABA_A receptors (Lodge et al. 2021, Cell Reports 37:109768). After we have blocked these receptors by applying a highly selective negative allosteric modulator $\alpha 5$ -NAM, the number of active cells was strongly increased in enriched animals. Taken together, environmental enrichment decreases the size of hippocampal cell assemblies during spatial exploration. This might be partially mediated by increased inhibition via dendrite-targeting interneurons.

Fully-primed slowly-recovering vesicles mediate LTP at neocortical neurons

Jana Nerlich¹, Iron Weichard¹, Holger Taschenberger², Grit Bornschein¹, Andreas Ritzau-Jost¹, Hartmut Schmidt¹, Robert J. Kittel³, Jens Eilers¹, Erwin Neher^{4,5}, Stefan Hallermann¹

¹Leipzig University, Carl-Ludwig-Institute for Physiology, Leipzig, Germany

²Max Planck Institute for Multidisciplinary Sciences, Department of Molecular Neurobiology, Göttingen, Germany

³Leipzig University, Institute of Biology, Department of Animal Physiology, Leipzig, Germany

⁴Max Planck Institute for Multidisciplinary Sciences, Emeritus Laboratory of Membrane Biophysics, Göttingen, Germany

⁵Georg August University, Cluster of Excellence 'Multiscale Bioimaging', Göttingen, Germany

Pre- and postsynaptic forms of long-term potentiation (LTP) are candidate synaptic mechanisms underlying learning and memory. A classical form of presynaptic LTP, referred to as synaptic redistribution, has been described for layer 5 pyramidal neurons. However, how this apparent increase in the release probability relates to recent advances in the understanding of priming of synaptic vesicles remains unclear. We therefore performed whole-cell recordings from layer 5 pyramidal neurons in acute cortical slices of rats in combination with extracellular stimulation of local excitatory inputs and analyzed the presynaptic function before and after the induction of LTP. LTP increased the EPSC amplitude by a median factor of 1.5 in half of the synapses. In these responder synapses, LTP increased synaptic depression during high-frequency transmission and slowed the recovery from depression by adding a second slow component to the time course of recovery. Analysis with a recently established two-step vesicle priming model indicates an increase in the number of fully-primed vesicles that recover slowly following stimulation. To further test this hypothesis, we pharmacologically stimulated the cyclic adenosine monophosphate (cAMP) and diacylglycerol (DAG) pathways, which are both known to promote synaptic vesicle priming. Both pharmacological manipulations indeed mimicked all features of electrically-induced LTP. Comparing presynaptic plasticity at various synapses revealed a general correlation that stronger synapses recover slower from synaptic depression, indicating that fully-primed vesicles rely on a slowly maturing release machinery. Our data show that LTP at layer 5 pyramidal neurons increases the synaptic strength primarily by enlarging a subpool of fully-primed slowly-recovering vesicles.

Homeostatic synaptic plasticity recruits coordinated structural and functional changes in superficial pyramidal neurons of the human neocortex

Maximilian Lenz¹, Pia Kruse¹, Amelie Eichler¹, Phyllis Stöhr¹, Jakob Straehle², Paul Turko³, Imre Vida³, Jürgen Beck^{2,4,5}, Andreas Vlachos^{1,4,5,6}

¹Department of Neuroanatomy, Institute of Anatomy and Cell Biology, Faculty of Medicine, University of Freiburg, Germany

²Department of Neurosurgery, Medical Center and Faculty of Medicine, University of Freiburg, Freiburg, Germany

³Institute of Integrative Neuroanatomy and NeuroCure Cluster of Excellence, Charité-Universitätsmedizin Berlin, Berlin, Germany

⁴CAST Center for Advanced Surgical Tissue analysis, Medical Center and Faculty of Medicine, University of Freiburg, Freiburg, Germany

⁵Center for Basics in Neuromodulation (NeuroModulBasics), Faculty of Medicine, University of Freiburg, Freiburg, Germany

⁶Center BrainLinks-BrainTools, University of Freiburg, Freiburg, Germany

Homeostatic synaptic plasticity aims at compensating for perturbations in network activity, thereby keeping neurons in a functional dynamic range. Among the mechanisms that regulate synaptic plasticity, coordinated structural and functional changes at synaptic sites represent a major hallmark in adaptive processes. Nevertheless, the precise regulatory mechanisms and the relevance of homeostatic plasticity in the human brain remain widely unknown. In this study, we investigated the impact of neuronal network silencing through pharmacological inhibition of voltage-gated sodium channels or glutamatergic neurotransmission (i.e., common targets of anticonvulsant substances) on functional and structural properties of murine and human cortical tissue. Using mouse organotypic tissue cultures and adult human neocortical slices, we demonstrated that network silencing promotes a compensatory functional and structural reorganization of excitatory synapses. Moreover, homeostatic synaptic adjustments were accompanied by distinct transcriptomic changes. These findings provide first experimental evidence for homeostatic synaptic plasticity in the adult human neocortex.

Homeostatic synaptic plasticity rescues neural coding reliability

Nadine Ehmann¹, Eyal Rozenfeld^{2,3}, Julia E. Maniom^{2,3}, Robert J. Kittel¹, Moshe Parnas^{2,3}

¹Department of Animal Physiology, Institute of Biology, Leipzig University, 04103 Leipzig, Germany

²Department of Physiology and Pharmacology, Sackler School of Medicine, Tel Aviv University, Tel Aviv 69978, Israel

³Sagol School of Neuroscience, Tel Aviv University, Tel Aviv 69978, Israel

In order to survive, animals must recognize reoccurring stimuli. A key requirement for the repeated identification of a stimulus is its reliable representation by the neural code on each encounter. Synaptic transmission underlies the propagation of neural codes between brain regions. A hallmark of chemical synapses is their plasticity, which enables signal transfer to be modified in an activity-dependent manner. Despite many decades of intense research on synapses, it remains unclear how the plastic features of synaptic transmission can maintain reliable neural coding. By studying the olfactory system of *Drosophila melanogaster*, we aimed to obtain a deeper mechanistic understanding of how synaptic function shapes neural coding reliability in the live, behaving animal. Here, we show that the properties of the active zone (AZ), the presynaptic site of neurotransmitter release, are critical for generating a reliable neural code. Reducing neurotransmitter release probability specifically at AZs of olfactory sensory neurons disrupted both neural coding and behavioral reliability. Strikingly, however, these defects were rescued within a day by target-specific synaptic plasticity, whereby a homeostatic increase in the number of AZs compensated the drop in release probability. These findings demonstrate an important role for synaptic plasticity in maintaining neural coding reliability and uncover an elegant mechanism through which the neural circuitry can counterbalance perturbations.

Inactivity induced homeostatic synaptic plasticity requires ECM remodeling

Bartomeu Perello Amoros¹, Fabian Zmiskol¹, Rahul Kaushik², Constanze Seidenbecher³,
Alexander Dityatev^{2,4}, Renato Frischknecht¹

¹Friedrich-Alexander-Universität Erlangen-Nürnberg, Department of Biology, Animal Physiology, Erlangen, Germany

²German Center for Neurodegenerative Diseases (DZNE)

³Leibniz Institute for Neurobiology, Department of Behavioral Neurology, Magdeburg, Germany

⁴Otto Von Guericke University, Center for behavioral Brain Sciences, Magdeburg, Germany

Neuronal networks are balanced by mechanisms of homeostatic plasticity, which adjust synaptic strength via molecular and morphological changes in the pre- and post-synapse. The perineuronal extracellular matrix (ECM) of the adult brain, which is mainly composed of chondroitin sulfate proteoglycans such as brevican stabilizes synapses and thereby reduces neuronal plasticity. Previous data indicate that brevican is cleaved during homeostatic plasticity and thereby may facilitate synapse remodeling. The proteases ADAMTS4, -5 and the closely related ADAMTS8, -9 and -15 may share brevican as substrate and are presumably responsible for ECM regulation. In order to elucidate the role of ADAMTS family members in homeostatic plasticity we quantified ADAMTS expression by qPCR in dissociated neuronal cultures after prolonged network silencing. Further, we investigated substrate specificity of ADAMTS family members in vitro. We used siRNAs to knock-down selected ADAMTS in neuronal cultures and quantified abundance of specific synaptic proteins regulated during network silencing. We found ADAMTS4 and -5 mRNA regulated during homeostatic plasticity. In contrast to ADAMTS4 and -5, neither ADAMTS8 nor ADAMTS15 cleaved brevican in vitro. In line with this finding downregulation of ADAMTS4 and -5, but not ADAMTS8 diminished cleavage of brevican in neuronal cultures. Furthermore, homeostatic regulation of synaptic proteins was abolished when interfering with ADAMTS function. In conclusion we found that ECM remodeling via ADAMTS4 and -5 derived cleavage of brevican is necessary for homeostatic regulation of synaptic plasticity and thus adjustment of neuronal networks.

Intermittent theta burst repetitive transcranial magnetic stimulation (rTMS) induces excitatory synaptic plasticity in human neocortical slices

Christos Galanis¹, Jakob Straehle^{1,2,3}, Elli Anna Balta¹, Dieter Henrik Heiland^{2,3,4}, Jürgen Beck^{2,3,5}, Andreas Vlachos^{1,3,5,6}

¹Department of Neuroanatomy, Institute of Anatomy and Cell Biology, Faculty of Medicine, University of Freiburg, Freiburg, Germany.

²Department of Neurosurgery, Medical Center and Faculty of Medicine, University of Freiburg, Freiburg, Germany.

³CAST Center for Advanced Surgical Tissue analysis, Medical Center and Faculty of Medicine, University of Freiburg, Freiburg, Germany.

⁴Microenvironment and Immunology Research Laboratory, Medical Center, University of Freiburg, Freiburg, Germany.

⁵Center for Basics in Neuromodulation (NeuroModulBasics), Faculty of Medicine, University of Freiburg, Freiburg, Germany.

⁶Center BrainLinks-BrainTools, University of Freiburg, Freiburg, Germany.

Repetitive transcranial magnetic stimulation (rTMS) is a non-invasive brain stimulation technique that modulates cortical excitability through the intact skin and skull. While rTMS is widely used in clinical settings for diagnostic and therapeutic interventions, the cellular and molecular mechanisms of rTMS-induced plasticity are not yet described in the human brain. Due to the fact that most of the data on rTMS-induced plasticity come from animal models, in this study we sought to explore the effects of rTMS in human brain tissue. We used neocortical access tissue obtained as part of routine neurosurgical procedures (and usually discarded), and generated acute neocortical slices within 15 minutes of tissue extraction. Using whole-cell patch-clamp recordings, light and electron microscopy and molecular biology techniques we assessed the effects of distinct rTMS parameters on plasticity of excitatory synapses onto layer 2/3 pyramidal neurons in human neocortical slices. Our results provide the first experimental evidence that intermittent theta burst stimulation (iTBS) protocols induce long-term potentiation of excitatory neurotransmission in human cortical tissue. We are currently characterizing the cellular and molecular mechanisms involved in rTMS-induced plasticity and investigate the effects of distinct rTMS parameters in human cortical slices. These studies may support the design of more effective rTMS protocols tailored to the treatment of individuals.

Light-induced ultrastructural synaptic plasticity in the mushroom body calyces of honeybees using STEM tomography

Nadine Kraft¹, Christian Stigloher², Wolfgang Rössler¹, Claudia Groh¹

¹University of Würzburg, Zoology II, Biocenter, Am Hubland, 97074 Würzburg, Germany

²University of Würzburg, Imaging Core Facility, Biocenter, Am Hubland, 97074 Würzburg, Germany

Honeybee (*Apis mellifera*) workers display a remarkable behavioral plasticity throughout adult life which is closely linked to structural changes in higher brain centers such as the multimodal mushroom bodies (MBs). Studies at the structural level revealed a dynamic plasticity of MB synaptic complexes, the microglomeruli (MG), in relation to environmental stimuli and intrinsic factors. Aging and the first exposure to light, for instance, correlate with the prominent behavioral transition from nurse bee to forager bee and are both usually accompanied by a pruning of presynaptic projection neuron (PN) boutons in the MB calyces. At the same time, as shown with serial-section electron microscopy, individual PN boutons increase their connectivity. This is reflected in a larger PN bouton size, an increase in active zones (AZs) as well as the number of postsynaptic partners per AZ indicating an increase of neuronal divergence at MB input synapses. To obtain an estimate of synaptic activity of PN boutons, it is crucial to also assess the density and type of synaptic vesicles within boutons. This, however, proves difficult with conventional transmission electron microscopy due to the small size of vesicles and their spatial overlap. Therefore, we aim to unravel these structural details by using scanning transmission electron microscopy (STEM) tomography. By consecutively tilting the specimen around the electron beam at defined angles and computing a tomogram, we can eliminate artifacts caused by superposition of structures and also acquire a detailed three-dimensional representation of presynaptic components within up to 350 nm thick sections. To investigate the effects of light exposure and age on the presynaptic architecture of PN boutons in a visual MB calyx subcompartment (the collar), we exposed dark-reared honeybee workers of different ages to a four-day light pulse program, while keeping another group in constant darkness. With subsequent STEM tomography of the brain samples, we aim to 3D reconstruct and quantify clear-core and dense-core vesicles as well as AZs within semi-thin sections of visual PN boutons and compare the data to freshly-emerged honeybees.

The work is funded by a DFG Sachbeihilfe to CG (GR 3305/2-1).

Longitudinal imaging of individual hippocampal synaptic sub-groups

Alessandro Francesco Ulivi^{1,2}, Hannah Klimmt^{1,2}, Bhargavi K.B. Murthy^{1,2}, Rosa Eva Huettl², Jinhyun Kim³, Alon Chen^{2,4}, Stefan Remy¹, Alessio Attardo^{1,2}

¹Leibniz Institute for Neurobiology, Department of Cellular Neuroscience, Brenneckestraße 6, 39118 Magdeburg, Germany

²Max Planck Institute of Psychiatry, Kraepelinstraße 2-10, 80804 Munich, Germany

³Korean Institute of Science and Technology, 5 Hwarang-ro 14-gil, 02792 Seongbuk-gu Seoul, Republic of Korea

⁴Weizmann Institute of Science, Herzl Street 234, 7610001 Rehovot, Israel

The two cornerstones of the investigation of the neurobiology of memory are the assumptions that memory formation is corresponded by a biochemical change of brain parenchyma, a trace called engram; and that synaptic plasticity is at the core of this process. The hippocampal formation is the site where synaptic long-term potentiation and depression were characterized, where place cells were discovered, and, finally, where engram cells – neuronal sub-populations which function as substrate for an engram – were first labelled and manipulated, by exploiting the expression of different molecular markers, as c-Fos and Arc. The manipulation of engram cells proved they are critical for processes as memory allocation, encoding, consolidation and expression. Still, many questions remain, especially at a synaptic level, about how an engram is allocated among different engram cells' synaptic sub-populations and how synaptic plasticity of different cellular sub-populations relates to memory acquisition and recall.

Optical deep brain imaging allows for repeated optical access to the hippocampal formation in living mice, thus it enables studying hippocampal engrams and their dynamics. By taking advantage of fluorescent activity reporters, several studies are investigating the activation patterns and codes underlying acquisition, consolidation and memory recall. While the vast majority of these studies focuses on the cellular and ensemble level, only a few attempt to bridge engram and hippocampal network's dynamics at the dendritic and synaptic levels. This is mostly due to technical difficulties, as - even by using state of the art optical imaging techniques - it is impossible to resolve all hippocampal pyramidal neurons' dendritic spines, that are currently used as proxies for excitatory synapses.

To fill this gap and to investigate how learning relates to engram cells' synaptic dynamics, I have established deep brain two-photon optical imaging of CA1 neurons localized in Stratum Oriens and Stratum Pyramidale and their synapses with Schaffer collateral projections from contralateral CA3, in live mice. To label individual synapses, I used the mammalian GFP Reconstitution Across Synaptic Partners (mGRASP) system, which exploits the expression of two GFP fragments, respectively delivered to the pre- and post-synaptic compartments, to visualize synapses after the full protein is reconstituted across the synaptic cleft. This technique offers several advantages over imaging of dendritic spines: 1) it labels true structural synapses. 2) It extends the imaging to aspiny synapses. 3) It labels synapses sparsely, thus ameliorating the limitations due to optical resolution. 4) It enables tracking the dynamics of distinct synaptic sub-groups, as pre- and post- mGRASP markers can be targeted to selective neuronal sub-populations. I will present repeated imaging – for the first time in living mice – of Schaffer collateral projections on either CA1 pyramidal neurons or parvalbumin-expressing inhibitory neurons. In addition, I will share my progress on the use of mGRASP to label synapses between active neurons.

LTP-induced dynamics of actin and spine geometry

Mitha Thomas^{1,2}, Michael Fauth^{1,2}

¹Third Institute of Physics - Biophysics, Georg August University Göttingen

²Bernstein Center for Computational Neuroscience Göttingen

Long-term potentiation of synapses is an important form of synaptic plasticity. It occurs in two phases: an early phase which constitutes a transient increase in synaptic strength, and a late phase which sustains this increase for a longer duration. The synaptic tagging and capture hypothesis states that the late phase is possible if the stimulus leads to a transient 'synaptic tag' in concurrence with the synthesis of plasticity-related proteins, which reorganise the post synaptic density. What acts as a 'tag' remains largely unknown. We follow the hypothesis that actin dynamics in interaction with spine geometry acts as a synaptic tag and test this using computational modelling.

Actin dynamics is assumed to occur in discrete foci of limited lifetimes within the spine. It involves mechanisms for filament branching, capping, uncapping, splitting, depolymerisation and nucleation of new foci.

As a first step to investigate LTP, we first study a single actin focus and introduce time-dependence for the above mechanisms. We observe that an increase in branching and splitting rates entails an increase in the lifetime of the focus and in actin activity. Likewise, increasing the capping rate and depolymerisation brings down actin activity and leads to shorter-lived foci. We then vary multiple processes simultaneously to study the concerted modulation of actin activity during LTP. Also, here we observe enhanced actin activity, which however only persists during the modulation.

Thus, as a next step, we simulate the changes in spine geometry related actin dynamics of multiple foci under LTP conditions. For this, we introduce the foci nucleation rate, a simplified spine area dynamics based on the number of foci as well as an actin crosslinker dynamics, which dictates the transitions between the stable and dynamic actin pools in the spine. We observe increases in spine area that sustain over time-scales similar to the synaptic tag.

Optogenetic activation of mGluR1 signaling induces synaptic plasticity in Purkinje cells

Lennard Rohr¹, Tatjana Surdin¹, Bianca Preissing¹

¹Ruhr-Universität-Bochum, Lehrstuhl für Zoologie und Neurobiologie

Neuronal plasticity underlying cerebellar learning behavior is strongly associated with type 1 metabotropic glutamate receptor (mGluR1) signaling. This receptor is located at perisynaptic sites at cerebellar Purkinje cells (PCs) and detects glutamate spill over. Activation of mGluR1 leads to activation of the Gq/11 pathway, inducing synaptic plasticity at the parallel fiber-Purkinje cell synapse (PF-PC) in form of long-term depression (LTD). To optogenetically modulate mGluR1 signaling, we fused mouse melanopsin (OPN4) that activates the Gq/11 pathway to the C-termini of mGluR1 splice variants (OPN4-mGluR1a and OPN4-mGluR1b). The created chimera increases calcium levels in HEK293 cells very similar to wild type OPN4. Additional PC activation can be observed upon blue light stimulation of OPN4-mGluR1a/b expressing cells in cerebellar slices. We show that light-dependent activation of OPN4-mGluR1a but not OPN4-mGluR1b induces LTD at the PF-PC synapse in vitro and leads to an increase in intrinsic cerebellar activity of PCs in vivo. Moreover, we demonstrate that light activation of mGluR1 signaling pathway by OPN4-mGluR1a in PCs increases cerebellum driven learning behavior.

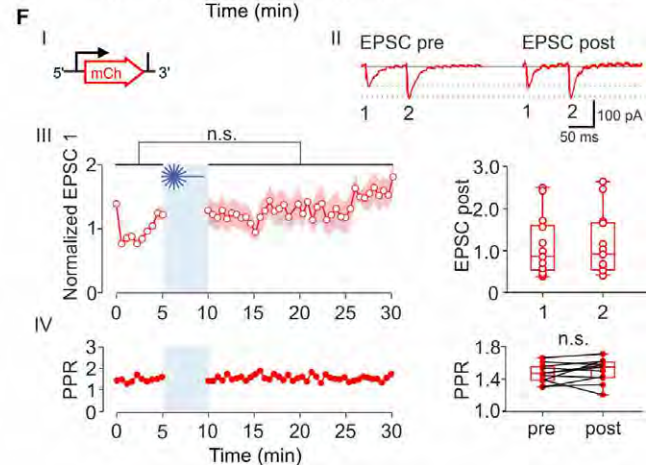
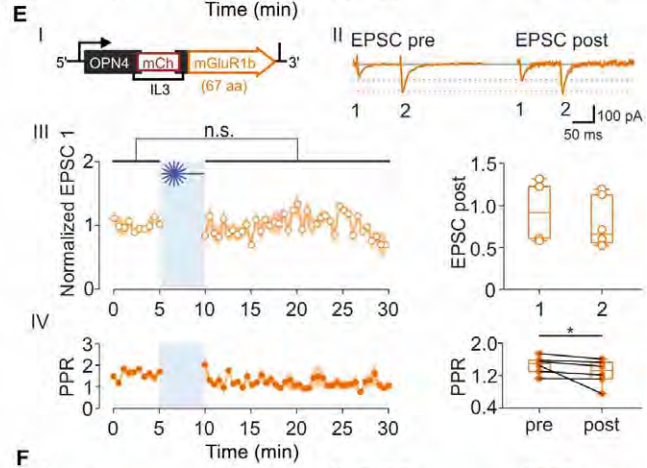
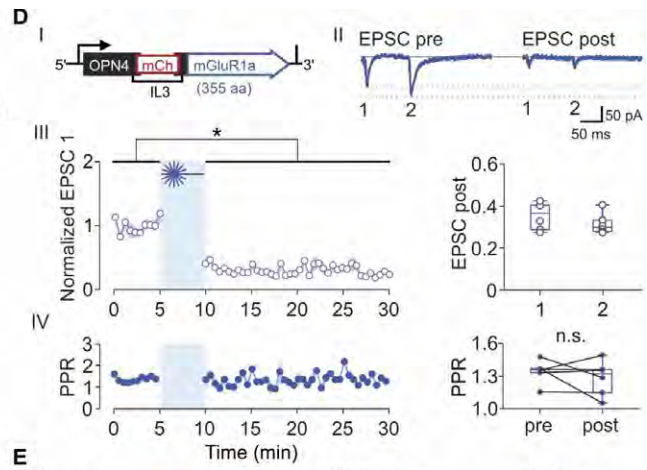
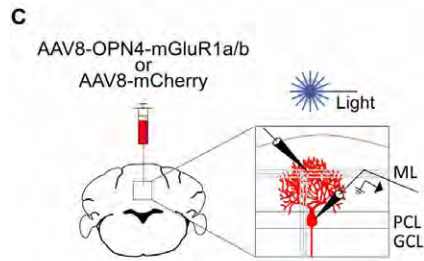
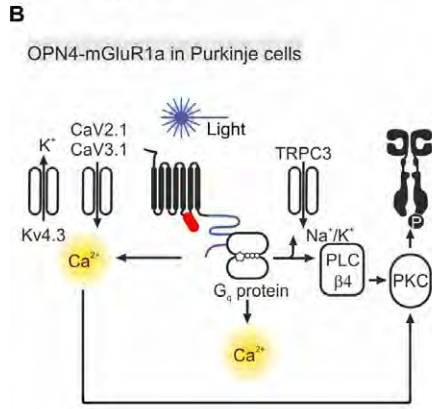
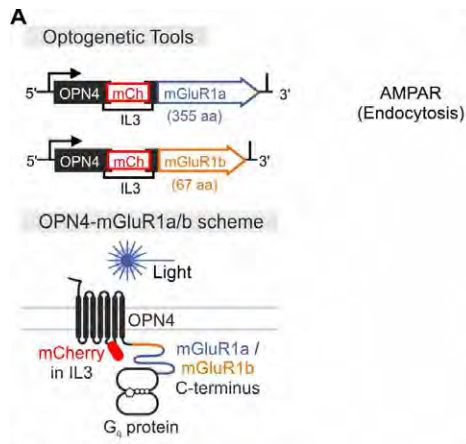

The molecular communication between synapses influences synaptic plasticity

Shirin Shafiee^{1,2}, Christian Tetzlaff²

¹University of Göttingen, III. Institute of Physics – Biophysics, Friedrich-Hund-Platz 1, 37077 Göttingen, Germany

²University Medicine Göttingen, Center for Biostructural Imaging of Neurodegeneration (BIN), Von-Siebold-Straße 3a, 37075 Göttingen, Germany

Synaptic plasticity induces synaptic changes on multiple time scales and is an essential component for learning, memory, and other cognitive functions of the brain. The detailed biophysical and structural properties underlying synaptic plasticity are still under discussion. Numerous modeling studies have focused on the properties of homosynaptic plasticity, while there are few theoretical models that can predict the crucial role of heterosynaptic plasticity – which refers to synaptic changes at inactive spines in response to homosynaptic changes at surrounding, active spines. Although experimental studies confirm the presence of heterosynaptic plasticity, its biophysical properties and functional implications remain unclear [1].

We propose a detailed computational model that describes electrical and chemical signaling along a dendrite. In order to comprise synaptic plasticity, we follow the calcium hypothesis in which the changes of synaptic strength are modulated by the dynamics of intracellular calcium in the dendritic spine according to which, a high level of calcium concentration $[Ca^{2+}]$ triggers induction of long-term potentiation (LTP), whereas moderate levels produce long-term depression (LTD) [2, 3]. We consider a nonlinear mathematical calcium model based on experimental studies that characterizes the convoluted temporal and spatial pattern of distribution of calcium ions in dendritic spines and the dendrite itself. We show that the change in the $[Ca^{2+}]$ level in a spine in response to stimulation can influence neighboring spines due to the diffusion of calcium ions. We show that such a diffusion along a dendrite establishes the well-known competitive and cooperative effects. Moreover, our results indicate a more complex and important role of heterosynaptic plasticity, as the calcium signal from a neighboring spine can strongly affect the implication of spike timing on homosynaptic plasticity by switching LTD to LTP or even LTP to LTD.

Overall, our analyses explain the diversity of heterosynaptic plasticity in a spike timing-dependent manner by considering electrical and chemical interactions between synapses, providing the basis for more complex learning rules to adapt neural networks.

Poster Topic

T9: Glia, Glia-Neuron Interactions

- [T9-1A](#) A subset of OPCs do not express Olig2 during development which can be increased in the adult by brain injuries and complex motor learning
Xianshu Bai, Lipao Fang, Qing Liu, Erika Meyer, Anna Welle, Wenhui Huang, Anja Scheller, Frank Kirchhoff
- [T9-2A](#) Buffering calcium signals in glia and neurons: a new conditional mouse line
Anne-Sophie Brauer, Julia Wolf, Ulrich Boehm, Dirk Dietrich, Susanne Schoch
- [T9-3A](#) cAMP signaling evoked by adenosine and dopamine in mouse olfactory bulb astrocytes
Marina Wendlandt, Levi von Kalben, Kristina Schulz, Daniela Hirnet, Christine Gee, Christian Lohr
- [T9-4A](#) Characterization of macroglia response during wound healing in laser-induced models of retinal degeneration
Laura Jahnke, Souska Zandi, Ahmed Elhelbawi, Nadia Mercader Huber, Federica Maria Conedera, Volker Enzmann
- [T9-5A](#) Deciphering the role of a non-neuronal lncRNA in age-associated cognitive diseases
Sophie Schröder, M. Sadman Sakib, André Fischer
- [T9-6A](#) From indicator to biosensor:
GCaMP for deciphering the complex Ca^{2+} activity of astrocytes
Andre Zeug, Franziska E. Müller, Evgeni Ponimaskin
- [T9-7A](#) Functional characterization of a novel lncRNA in the aging brain
Ranjit Pradhan, M Sadman Sakib, Lalit Kaurani, Deborah Kronenberg-Versteeg, Dennis M Krüger, Sophie Schröder, Andre Fischer
- [T9-8A](#) Role of glial gap junctions in the development and progression of temporal lobe epilepsy
Oussama Kherbouche, Lukas Henning, Gerald Seifert, Pia Niemann, Bernd Fleischmann, Peter Bedner, Christian Steinhäuser
- [T9-1B](#) GABAergic calcium-signals in astrocytes of the mouse medial prefrontal cortex
Alina Kürten, Jennifer Bostel, Dr. Antonia Beiersdorfer
- [T9-2B](#) Glioma and Native CNS Cells in 3D Ultraweak Hydrogels: Cell-Cell and Cell-Matrix Interactions

Mateo Sebastian Andrade Mier, Carmen Villmann, Torsten Blunk

- [T9-3B](#) Impact of 5-HT₄R Signaling on Morphology and Function of hippocampal Astrocytes
Franziska E. Müller, Evgeni Ponimaskin, Andre Zeug
- [T9-4B](#) Impact of AMPA receptors in NG2 glia on signal transmission in the hippocampus and cerebellum
Dario Tascio, Gerald Seifert, Nehal Gebriel, Frank Kirchhoff, Ronald Jabs, Christian Henneberger, Christian Steinhäuser
- [T9-5B](#) Multiscale Correlational Imaging of Sex-Specific Structural Brain Changes During Chronic Pain
Tabea Susanna Kampen, Amrita Das Gupta, Jennifer John, Claudia Falfán-Melgoza, Carlo A. Beretta, Wolfgang Weber-Fahr, Thomas Kuner, Johannes Knabbe
- [T9-6B](#) NG2 glia-specific Kir4.1 knockout as a tool to understand the impact of neuron-glia synaptic signaling
Gerald Seifert, Dario Tascio, Ronald Jabs, Aline Timmermann, Anne Boehlen, Magdalena Skubal, Catia Domingos, Wenhui Huang, Frank Kirchhoff, Christian Henneberger, Andras Bilkei-Gorzo, Christian Steinhäuser
- [T9-7B](#) OPCs shape the medial prefrontal cortical inhibition by regulating interneuron apoptosis and myelination employing GABA_B receptor
Lipao Fang, Na Zhao, Laura C Caudal, Renping Zhao, Ching-Hsin Lin, Hsin-Fang Chang, Nadine Heinz, Carola Meier, Wenhui Huang, Anja Scheller, Frank Kirchhoff, Xianshu Bai
- [T9-8B](#) Quantification of cellular Na⁺ employing rapidFLIM in the mouse hippocampus
Jan Meyer, Karl W. Kafitz, Christine R. Rose
- [T9-2C](#) Role of hevin in drug addiction
Vincent Vialou
- [T9-3C](#) Serotonin_{1A}-Receptor mediated signaling in Astrocytes and its influence on depression-like behavior
Svenja Bremshey, Michael Koch, Olivia A. Masseck
- [T9-4C](#) The axonal vesicle release machinery and myelination
Julia Wolf, Silvia Cases-Cunillera, Susanne Schoch, Dirk Dietrich
- [T9-5C](#) The impact of synaptic signaling activity on hippocampal microglia
Frederieke Sophie Moschref, Nils Brose, Benjamin H. Cooper
- [T9-6C](#) The synaptic vesicle protein Mover/TPRG1L is associated with lipid droplets in astrocytes
Jeremy Krohn, Florelle Domart, Thanh Thao Do, Thomas Dresbach
- [T9-7C](#) Viral approaches to elucidate the function of different tanycytic subpopulations
Vanessa Neve, Helge Müller-Fielitz, Frauke Spiecker, Anke Fähnrich, Ruben Nogueiras, Vincent Prevot, Markus Schwaninger

[T9-8C](#) Wrapping glia influence on larval reorientation
Marit Praetz, Christian Klämbt

A subset of OPCs do not express Olig2 during development which can be increased in the adult by brain injuries and complex motor learning

Xianshu Bai¹, Lipao Fang¹, Qing Liu¹, Erika Meyer¹, Anna Welle², Wenhui Huang¹, Anja Scheller¹, Frank Kirchhoff¹

¹University of Saarland, Molecular Physiology, Kirrbergerstrasse 100, 66421 Homburg, Germany

²University of Saarland, Department of Genetics and EpiGenetics, Saarbrücken, Germany

Oligodendrocyte precursor cells (OPCs) are uniformly distributed in the mammalian brain, however their function is rather heterogeneous in respect to their origin, location, receptor/channel expression and age. The basic helix-loop-helix transcription factor Olig2 is expressed in all OPCs as a pivotal determinant of their differentiation. Here, we identified a subset (2-26%) of OPCs lacking Olig2 in various brain regions including cortex, corpus callosum, CA1 and dentate gyrus. These Olig2 negative (Olig2^{neg}) OPCs were enriched in the juvenile brain and decreased subsequently with age, being rarely detectable in the adult brain. However, the loss of this population was not due to apoptosis or microglia-dependent phagocytosis. Unlike Olig2^{pos} OPCs, these subset cells could not be labelled for the mitotic marker Ki67. And, accordingly, BrdU was incorporated only by a three-day long-term labeling but not by a two-hour short pulse, suggesting these cells do not proliferate any more but were derived from proliferating OPCs. The Olig2^{neg} OPCs exhibited a less complex morphology than Olig2^{pos} ones. Olig2^{neg} OPCs preferentially remain in a precursor stage rather than differentiating into highly branched oligodendrocytes. Changing the adjacent brain environment, e.g. by acute injuries or by complex motor learning tasks, stimulated the transition of Olig2^{pos} OPCs to Olig2^{neg} cells in the adult. Taken together, our results demonstrate that OPCs transiently suppress Olig2 upon changes of the brain activity.

Buffering calcium signals in glia and neurons: a new conditional mouse line

Anne-Sophie Brauer¹, Julia Wolf², Ulrich Boehm³, Dirk Dietrich⁴, Susanne Schoch⁵

¹Department of Neuropathology, Section for Translational Epilepsy Research, University Hospital Bonn, 53127 Bonn, Germany

²Department of Neurosurgery, University Hospital Bonn, 53127 Bonn, Germany

³Center for Molecular Signaling (PZMS), experimental pharmacology, Saarland University School of Medicine, 66421 Homburg, Germany

⁴Department of Neurosurgery, University Hospital Bonn, 53127 Bonn, Germany

⁵Department of Neuropathology, Section for Translational Epilepsy Research, University Hospital Bonn, 53127 Bonn, Germany

Intracellular free calcium functions as an important second messenger for the control of a variety of cellular functions, in particular those that are regulated by external stimuli. This is achieved by maintaining a low cytoplasmic Ca^{2+} concentration in basal conditions and by strongly increasing it in response to a stimulus. A change in the Ca^{2+} concentration underlies synaptic communication between neurons by controlling the release of neurotransmitter-filled vesicles and by driving intracellular pathways that have an effect on gene expression. In order to enable the examination of the influence of calcium in different cell types and regarding different research questions, we have generated a novel conditional transgenic mouse line: Rosa26.CMV.loxPSTOP.mCherry-T2A-Calretinin. In this mouse line the rapid and high affinity calcium binding protein calretinin will be expressed in cells upon Cre-Recombinase activity. The fluorescent reporter mCherry indicates cells that have undergone recombination. To characterize the functionality and specificity of this newly developed line, we have crossed Rosa26.mCherry-T2A-Calretinin mice with two Cre-driver lines: 1.NG2-CreER mice to limit calretinin and mCherry expression specifically to NG2 cells and 2. Prox-Cre mice that express Cre and therefore also mCherry and calretinin specifically in the dentate granule cells of the dentate gyrus. Using immunocytochemistry, we show that Cre-mediated recombination induces expression of mCherry and Calretinin selectively in those cells that contain Cre-Recombinase and analyse the time course and persistence of expression. Taken together, we have developed a novel mouse line that can be used to address the impact of reduced calcium signalling on different intracellular functions, for example in the activity dependent regulation of myelination through synaptic communication between NG2 cells and surrounding neurons.

cAMP signaling evoked by adenosine and dopamine in mouse olfactory bulb astrocytes

Marina Wendlandt¹, Levi von Kalben¹, Kristina Schulz¹, Daniela Hirnet¹, Christine Gee²,
Christian Lohr¹

¹Division of Neurophysiology, University of Hamburg, Hamburg, Germany

²Institute for Synaptic Physiology, Center for Molecular Neurobiology Hamburg, University Clinic Hamburg-Eppendorf, Hamburg, Germany

Astrocytes represent a large proportion of cells in the central nervous system. Calcium signaling has been the focus of astrocytic research for a long time and less is known about cyclic adenosine monophosphate (cAMP) signaling pathways and interactions in this cell type. In this study, adeno-associated viruses (AAV) carrying the fluorescent cAMP indicator Flamindo2 gene under control of the astrocyte-specific GFAP promoter were introduced into mice by retrobulbar injection to allow for visualization of cAMP signals in astrocytes. Astrocytes expressing Flamindo2 were studied by confocal microscopy in acute brain slices of olfactory bulbs. In addition, the expression of Flamindo2 in astrocytes was verified by immunohistological staining.

Adenosine and dopamine are known to be able to induce both an increase and a decrease in cAMP concentration, depending on the receptor subtype activated. In olfactory bulb astrocytes, bath application of adenosine and dopamine evoked transient cAMP signals recorded by Flamindo2 cAMP imaging in the present study. A_{2A} adenosine receptors are known to stimulate adenylate cyclase. They could be induced by adenosine and the A_{2A} agonist PSB 0777 and blocked by the A_{2A} antagonist ZM 241385. In addition, cAMP responses triggered by ATP could also be blocked by ZM 241385, suggesting that ATP is degraded to adenosine that stimulates A_{2A} receptors. In contrast to A_{2A} receptors, A₁ receptors inhibit adenylate cyclase and decrease the cAMP concentration. The A₁ receptor agonist N⁶-CPA and the more specific agonist 2'MeCCPA did not evoke a decrease in resting cAMP concentration. In addition, even when cAMP concentration was raised by forskolin, the A₁ agonists failed to reduce the cAMP concentration.

Increases in the cAMP concentration could also be evoked by ATP release from olfactory receptor neurons excited by electrical stimulation of their axons. Here, too, the antagonist ZM 241385 blocked the cAMP response. In summary, our results indicate that olfactory bulb astrocytes express adenosine and dopamine receptors that stimulate cAMP signaling. Adenosine receptors include A_{2A} receptors that are activated by adenosine derived from synaptically released ATP, while A₁ receptors appear not be involved.

Supported by the DFG (project number 335447717).

Characterization of macroglia response during wound healing in laser-induced models of retinal degeneration

Laura Jahnke^{1,2,3}, Souska Zandi^{1,2}, Ahmed Elhelbawi^{3,4}, Nadia Mercader Huber⁵,
Federica Maria Conedera⁶, Volker Enzmann^{1,2}

¹Dept. of Ophthalmology, Inselspital, Bern University Hospital, University of Bern, Bern Switzerland

²Dept. of BioMedical Research, University of Bern, Bern Switzerland

³Graduate School for Cellular and Biomedical Sciences, University of Bern, Bern Switzerland

⁴Dept. of Chemistry, Biochemistry and Pharmaceutical Sciences, University of Bern, Bern Switzerland

⁵Inst. of Anatomy, University of Bern, Bern, Switzerland

⁶Dept. of Medicine, University of Fribourg, Fribourg, Switzerland

Background

Reactive gliosis is developing during retinal damage and involves homing of macroglia cells. Such process is also associated with chronic degenerative diseases such as age-related macular degeneration (AMD) or retinitis pigmentosa (RP). Here, we investigated the gliotic response to explore the role of S100 β and the intermediate filaments (IF) GFAP, vimentin and nestin during wound healing in a laser-induced model of retinal degeneration and validated the results with human retinal donor samples.

Methods

Experiments were performed in two different animal models, zebrafish (ZF) and mouse. Thereby, a diode laser (532 nm) was used to induce focal lesions (mouse: 300 μ m; ZF: 50 μ m) in the outer retina double the disc diameter of the optic nerve away. At different time points post injury induction, the kinetics of retinal degeneration and regeneration were assessed by H&E. Immunofluorescence was performed to evaluate Müller cell (GS) and astrocyte (GFAP) injury response and to distinguish between both cell types. Additionally, the stainings were also performed in human retinal sections containing drusen.

Results

Focal laser treatment elevated the expression of gliotic markers in the area of the damage. This was associated with increased expression of S100 β , GFAP, vimentin and nestin in mouse and human. In zebrafish, we could detect S100 β at the first time point but no GFAP nor nestin positivity was found over time. Thereby, double positive cells with all selected glia markers were detected in all models. However, in zebrafish no double positive GFAP/GS was detected on days 10 and 17 as were no S100 β /GS double positive cells on day 12.

Conclusions

Macroglia cells showed a different pattern in expression of IFs in regenerative and degenerative models. In particular, S100 β and nestin may prove to be markers to inhibit when it comes to largely suppressing chronic gliosis in retinal dystrophies such as AMD.

Deciphering the role of a non-neuronal lncRNA in age-associated cognitive diseases

Sophie Schröder¹, M. Sadman Sakib¹, André Fischer^{1,2,3}

¹Department for Epigenetics and Systems Medicine in Neurodegenerative Diseases, German Center for Neurodegenerative Diseases (DZNE), Göttingen, Germany

²Department of Psychiatry and Psychotherapy, University Medical Center, Göttingen, Germany

³Cluster of Excellence "Multiscale Bioimaging: from Molecular Machines to Networks of Excitable Cells" (MBExC), University of Göttingen, Germany

Long non-coding RNAs (lncRNAs) are emerging as important regulators of neuronal plasticity and have recently been linked to the onset and progression of neurodegenerative diseases. However, our knowledge about the role of CNS-specific lncRNAs in neuronal and non-neuronal cells is still limited. The aim of this project was to identify cell type-specific expression changes of non-neuronal lncRNAs in the context of age-associated neurodegenerative diseases and to characterize their function. To this end, we performed an RNA sequencing-based screening in the hippocampus of young and cognitively impaired aged mice. We identified multiple candidate lncRNAs for further analysis and studied their role in the relevant cell types via gain and loss of function approaches. Our data reveal that the candidate lncRNAs regulate several key cellular pathways and could serve as biomarker for cognitive decline and therapeutic interventions via RNA-based medicines.

From indicator to biosensor: GCaMP for deciphering the complex Ca^{2+} activity of astrocytes

Andre Zeug¹, Franziska E. Müller¹, Evgeni Ponimaskin¹

¹Hannover Medical School, Cellular Neurophysiology, Carl-Neuberg-Str. 1, 30625 Hannover, Germany

Recent achievements in bio-indicator optimization and imaging techniques promote the exploration of Ca^{2+} activity as useful readout for analysis of the brain functions. With progressing research, astrocytes were identified as important regulators of the brain network. They possess a highly complex morphology and are characterized by spontaneous Ca^{2+} activity. Recently, we presented MTED - a Multi-Threshold-based Event Detection - algorithm (Müller et al., 2021), which enables the analysis of astrocytic Ca^{2+} activity and provides differentiated and in-depth characterization of Ca^{2+} signal complexity. The application of GCaMP-based Ca^{2+} indicators only allows to monitor relative changes in $[\text{Ca}^{2+}]$, since the signal is treated as $\Delta F/F_0$, which relies on the indicator fluorescence signal at basal Ca^{2+} concentration ($[\text{Ca}^{2+}]_{\text{basal}}$). In case of different $[\text{Ca}^{2+}]_{\text{basal}}$, F_0 calculation is biased and $\Delta F/F_0$ can be misinterpreted.

To bring astrocyte Ca^{2+} imaging to a more quantitative level, we covalently linked GCaMP6s to the bright, red fluorescent protein tdTomato, which now can be used as a ratiometric Ca^{2+} biosensor. By treating the biosensor readout as $\Delta F/F_R$, where F_R is the fluorescence signal of the ruler tdTomato, we can identify variations in $[\text{Ca}^{2+}]_{\text{basal}}$ and thus correctly address changes in $\Delta[\text{Ca}^{2+}]$.

With this ratiometric Ca^{2+} biosensor, we identify differences in $[\text{Ca}^{2+}]_{\text{basal}}$ between central and distal regions within astrocytes and, more importantly, substantial differences of astrocytic $[\text{Ca}^{2+}]_{\text{basal}}$ within brain regions. Ultimately, the interpretation of $\Delta F/F_R$ as $\Delta[\text{Ca}^{2+}]$ allows to investigate the functional consequences of astrocytic Ca^{2+} activity in respect to other signaling circuits.

Müller, F. E., Cherkas, V., Stopper, G., Caudal, L. C., Stopper, L., Kirchhoff, F., Henneberger, C., Ponimaskin, E. G., & Zeug, A. (2021). Elucidating regulators of astrocytic Ca^{2+} signaling via multi-threshold event detection (MTED). *Glia*, 69(12), 2798–2811. <https://doi.org/10.1002/glia.24070>

Functional characterization of a novel lncRNA in the aging brain

Ranjit Pradhan¹, M Sadman Sakib¹, Lalit Kaurani¹, Deborah Kronenberg-Versteeg²,
Dennis M Krüger¹, Sophie Schröder¹, Andre Fischer^{1,3,4}

¹Department for Epigenetics and Systems Medicine in Neurodegenerative Diseases, German Center for Neurodegenerative Diseases, Goettingen, Germany

²Hertie Institute for Clinical Brain Research, University of Tuebingen, Germany

³Department of Psychiatry and Psychotherapy, University Medical Center, Göttingen, Germany

⁴Cluster of Excellence "Multiscale Bioimaging: from Molecular Machines to Networks of Excitable Cells" (MBExC), University of Göttingen, Germany

Long non-coding RNAs (lncRNAs) are non-protein coding transcripts that have emerged as major regulators of cellular and molecular function in the central nervous system (CNS). In this study, we aimed to identify and characterize lncRNA that are de-regulated in the aging brain. We employed FANS to sort neuronal and non-neuronal nuclei from the hippocampus of 3- and 16-month-old mice and performed total RNA sequencing. Computational analysis of the sequencing results revealed several candidate lncRNAs. Further expression analysis identified a novel candidate lncRNA enriched in microglia, the resident immune cells of the CNS that play a central role in age-related CNS disorders. Knock down of this candidate lncRNA in primary mouse microglia and in human iPSC-derived microglia led to an upregulation of inflammatory pathways and increased phagocytic activity. In conclusion, we identify a novel lncRNA that is deregulated in the aging brain and orchestrates microglia function.

Role of glial gap junctions in the development and progression of temporal lobe epilepsy

Oussama Kherbouche¹, Lukas Henning¹, Gerald Seifert¹, Pia Niemann², Bernd Fleischmann², Peter Bedner¹, Christian Steinhäuser¹

¹Institute of Cellular Neurosciences and ²Institute of Physiology 1, Medical Faculty, University of Bonn, Bonn, Germany

The gap junction-connected astroglial network plays a central role in the regulation of synaptic transmission and synchronization of neuronal networks. Dysregulations in astrocytic communication have been associated with various neurological disorders, including epilepsy (1,2,3). To further elucidate the role of interastrocytic coupling in the healthy and diseased brain, we generated a mouse line with inducible astrocyte-specific over-expression of the gap junction protein connexin43 (Cx43). The aim of this project is to investigate the consequences of Cx43 over-expression on astrocytic morphology, synaptic plasticity, learning and memory, adult neurogenesis, as well as on the development and progression of temporal lobe epilepsy (TLE). Characterization of Cx43 over-expressing mice revealed a high recombination efficiency and astrocyte specificity in the hippocampus. Western blot analysis and biocytin diffusion studies demonstrated that in the hippocampus of over-expressing mice, Cx43 protein levels as well as the coupling efficiency of astrocytes was increased. Whole-cell patch-clamp recordings showed that over-expression did not affect the membrane properties of astrocytes. Preliminary immunohistochemistry indicates that astrocyte number and morphology were also unaffected in Cx43 overexpressing mice while adult neurogenesis in the dentate gyrus is slightly decreased. Currently, we are investigating consequences of enhanced interastrocytic coupling on synaptic plasticity and epileptogenesis.

Supported by EU (H2020-MSCA-ITN, project 722053 EU-GliaPhD), BMBF (01DN20001 CONNEX) and Bonn University (BONFOR 2022-4-05).

1. Bedner, P. et al. *Brain* 138, 1208 (2015).
2. Deshpande, T. et al. *Glia* 68, 2136 (2020).
3. Pannasch, U. et al. *PNAS* 108, 8467(2011).

GABAergic calcium-signals in astrocytes of the mouse medial prefrontal cortex

Alina Kürten¹, Jennifer Bostel¹, Dr. Antonia Beiersdorfer²

¹University of Hamburg, Division of Neurophysiology, Martin-Luther-King-Platz 3, 20146 Hamburg , Germany

The medial prefrontal cortex (mPFC) is a cortical brain region whose multifaceted functions are based on a complex interplay between excitatory pyramidal neurons, inhibitory GABAergic interneurons and astrocytes. Astrocytes express specific GABA receptors that mediate intracellular astrocytic Ca²⁺ signaling upon stimulation by the inhibitory neurotransmitter γ -aminobutyric acid (GABA). It has already been shown that those GABA-induced Ca²⁺ signals in mPFC astrocytes are mediated mainly via the metabotropic GABAB receptor. However, the precise molecular basis leading to the generation of GABA-induced Ca²⁺ signals in mPFC astrocytes and the exact reciprocal communication mechanisms between GABAergic parvalbumin positive interneurons and astrocytes within the mPFC remain largely unsolved.

In this study, it was to determine whether the GABAB receptor-mediated increase in intracellular Ca²⁺ concentration in astrocytes of the mPFC is based on Ca²⁺ release from intracellular Ca²⁺ stores such as the endoplasmic reticulum or is due to Ca²⁺ influx from the extracellular space. In addition, the signaling cascade that induces Ca²⁺ release from intracellular Ca²⁺ stores should be deciphered. It could be shown that a GABAB receptor-mediated increase in intracellular Ca²⁺ concentration in the astrocytes of the mPFC is mainly based on an IP₃ receptor-mediated Ca²⁺ release from intracellular Ca²⁺ stores. In addition, it was shown that an influx of extracellular Ca²⁺ seems to be involved in the increase of intracellular Ca²⁺ concentration.

Glioma and Native CNS Cells in 3D Ultraweak Hydrogels: Cell-Cell and Cell-Matrix Interactions

Mateo Sebastian Andrade Mier¹, Carmen Villmann¹, Torsten Blunk²

¹University Clinic Würzburg, Institute for Clinical Neurobiology, Verbacherstr. 5, 97078 Würzburg, Germany

²University Clinic Würzburg, Department of Trauma, Hand, Plastic and Reconstructive Surgery, Oberdürrbacher Str. 6, 97080 Würzburg, Germany

Glioblastoma multiforme is the most malignant brain tumor. Glioma cells interact in distinct ways with their surrounding microenvironment. Cell-cell interaction as well as extracellular matrix (ECM) remodeling are essential components of the tumor pathophysiology. Glioma cells are able to interact with surrounding cells through a myriad of mechanisms. These interactions include gap junctions, extracellular vesicles, nano- and microtubes that are able to send molecules and factors and thus manipulating native brain cells. Moreover, the ECM is either directly remodeled by glioma cells or indirectly by native CNS cells that have been manipulated.

It has been previously shown that a hyaluronic acid-based hydrogel (around 100 Pa) when reinforced with melt-electro written scaffolds represents an optimal composite for the co-culture of primary cortical neurons and astrocytes. Within such composites, neurons are able to mature and develop synapses and functional neuronal networks. Astrocytes on the other hand are able to migrate into the gel and distribute evenly (1). Similar results have been reported with the use of Matrigel (2), which is ECM extracted from mouse sarcoma. Developing our own hydrogel formulation further, we have designed co-cultures with the use of ultra-soft hydrogels that mimic native brain ECM.

It is possible to determine the distribution and organization of ECM proteins in hydrogels such as Matrigel when neurons are cultured (Fig.1). Additionally, hyaluronic acid-based hydrogels allow the detection of autonomously produced ECM proteins by neurons or astrocytes. Determining the composition and distribution of ECM proteins in these *in vitro* models, will help to understand fundamental mechanisms for neuronal maturation and growth as well as ECM remodeling under pathological conditions, e.g. in the presence of tumor cells.

Co-cultures of astrocytes together with U87 glioma cells in Matrigel allow growth of both cell types. It is possible to estimate contact points between these cells (Fig.1, lower right). It seems that cell-cell contacts are promoted by the 3D environment when compared to similar 2D *in vitro* models.

Altogether, the aim of the project is to further characterize the cell-cell interactions as well as the cell-matrix interactions for glioblastoma multiforme.

References:

1. Janzen D, Bakirci E, Faber J, Mier MA, Hauptstein J, Pal A, et al. Reinforced Hyaluronic acid-based Matrices promote 3D Neuronal Network Formation. *Adv Healthc Mater.* 2022:e2201826.
2. Janzen D, Bakirci E, Wieland A, Martin C, Dalton PD, Villmann C. Cortical Neurons form a Functional Neuronal Network in a 3D Printed Reinforced Matrix. *Adv Healthc Mater.* 2020;9(9):e1901630.

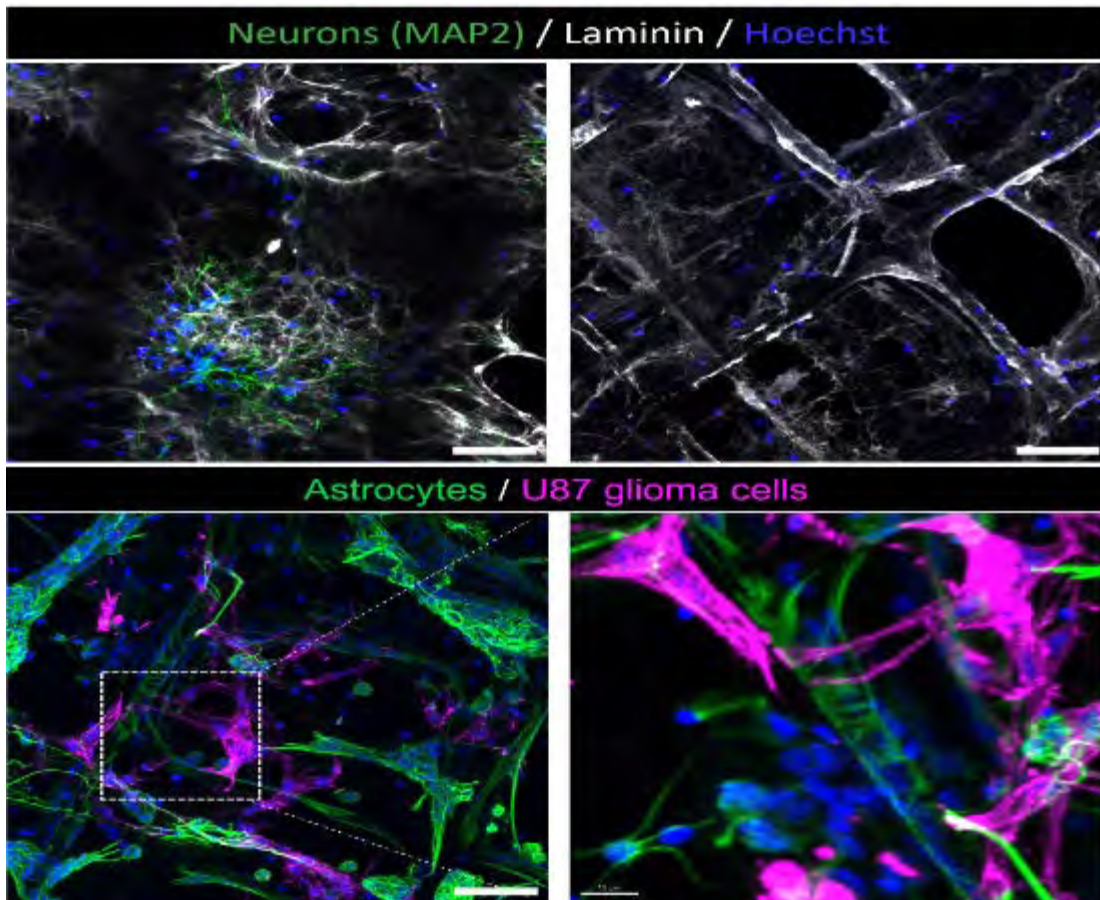

Figure 1. Upper images show cortical neurons in 3D cultures using scaffold reinforced Matrigel (14 days). Neurons can be seen already forming networks (MAP2, green). Laminin (white) seems to be highly organized. Lower images demonstrate a co-culture of astrocytes (green) and U87 glioma cells (magenta) in scaffolds reinforced Matrigel. Contact points between cell types as highlighted (lower right).

Impact of 5-HT4R Signaling on Morphology and Function of hippocampal Astrocytes

Franziska E. Müller¹, Evgeni Ponimaskin¹, Andre Zeug¹

¹Hanover Medical School, Cellular Neurophysiology, Carl-Neuberg-Str.1, 30625 Hannover, Germany

Serotonin is an important neurotransmitter regulating numerous brain functions via activation of specific serotonin receptors (5-HTRs), known to be expressed by neurons but also by astrocytes. The unique morphology of these glia cells allows single astrocytes to modulate thousands of synapses over distinct anatomical regions. We have recently shown that the serotonin receptor 4 (5-HT4R) can shape astrocyte morphology (Müller, Schade, et al., 2021). This is mediated by the Gα13-RhoA signaling axis, which also regulates excitatory synaptic circuits.

Astrocytes show fluctuations of intracellular Ca²⁺, which are regarded to be a special way of signaling and may allow communication between astrocytes, orchestrating an astrocyte network. We now investigate how astrocyte morphology correlates with their Ca²⁺ dynamics, and how these can be shaped by 5-HT4R signaling. We apply our multi-threshold event detection (MTED) approach (Müller, Cherkas, et al., 2021) combined with morphology recordings and pharmacological manipulation of 5-HT4R signaling. By stimulating primary astrocytes with 5-HT receptor subtype specific agonists, we receive distinct responses of astrocytic Ca²⁺ event patterns, which indicates a direct implication of the 5-HT signaling pathway. Thus, 5-HT4R activation in astrocytes may not only affect their morphology and the activity of nearby neurons, but may also be involved into inter-astrocyte communication.

Müller, F. E., Cherkas, V., Stopper, G., Caudal, L. C., Stopper, L., Kirchhoff, F., Henneberger, C., Ponimaskin, E. G., & Zeug, A. (2021). Elucidating regulators of astrocytic Ca²⁺ signaling via multi-threshold event detection (MTED). *Glia*, 69(12), 2798–2811. <https://doi.org/10.1002/glia.24070>

Müller, F. E., Schade, S. K., Cherkas, V., Stopper, L., Breithausen, B., Minge, D., Varbanov, H., Wahl-Schott, C., Antoniuk, S., Domingos, C., Compan, V., Kirchhoff, F., Henneberger, C., Ponimaskin, E., & Zeug, A. (2021). Serotonin receptor 4 regulates hippocampal astrocyte morphology and function. *Glia*, 69(4), 872–889. <https://doi.org/10.1002/glia.23933>

Impact of AMPA receptors in NG2 glia on signal transmission in the hippocampus and cerebellum

Dario Tascio¹, Gerald Seifert¹, Nehal Gebril¹, Frank Kirchhoff², Ronald Jabs¹, Christian Henneberger³, Christian Steinhäuser¹

¹Institute of Cellular Neurosciences, Medical Faculty, University of Bonn, Bonn, Germany

²Center for Integrative Physiology and Molecular Medicine, University of Saarland, Homburg, Germany

³German Center for Neurodegenerative Diseases (DZNE), Bonn, Germany

Grey matter NG2 glia constitute a heterogeneous glial population whose functions remain incompletely understood. In the hippocampus, Schaffer collaterals activate AMPA receptors (AMPA receptors) in NG2 glia, giving rise to small post-synaptic currents (PSCs) (1, 2). Cerebellar climbing fibers can also form synapses with NG2 glia, producing much larger PSCs (3). We aim to assess mechanisms underlying these regional differences and better understand the role of NG2 glia AMPARs in influencing the activity of neuronal networks.

Combined patch-clamp and RT-PCR analyses allowed for determining properties and functions of AMPARs expressed by cerebellar NG2 glia, and comparing them with their hippocampal counterpart. Field potential recordings (fEPSPs) were conducted in slices from mice with inducible deletion of AMPARs GluA1-4 in NG2 glia (GluA1-4^{-/-}).

RT-PCR data suggested selective expression of the auxiliary AMPAR subunit TARPs in cerebellar NG2 glia, which is required for translocation of Ca²⁺-permeable (CP) AMPARs to the plasma membrane. Comparing excitatory PSCs in NG2 glia of both regions while applying CP-AMPA antagonists revealed a higher expression of those receptors in the cerebellum. fEPSPs recordings in slices from GluA1-4^{-/-} mice unraveled impaired long term potentiation (LTP) in both regions. These findings help explaining divergent properties of NG2 glia AMPARs in the hippocampus and cerebellum. Currently, we are investigating whether the impaired plasticity in GluA1-4^{-/-} mice can be rescued pharmacologically, to identify potential mechanisms by which NG2 glia influence neuronal networks.

Supported by DFG SPP1757 (STE 552/5, SE 774/6)

1. D. E. Bergles et al., Nature 405, 187 (2000).
2. R. Jabs et al. J. Cell Sci. 118, 3791 (2005).
3. S. C. Lin et al., Neuron 46, 773 (2005).

Multiscale Correlational Imaging of Sex-Specific Structural Brain Changes During Chronic Pain

Tabea Susanna Kampen¹, Amrita Das Gupta¹, Jennifer John¹, Claudia Falfán-Melgoza², Carlo A. Beretta¹, Wolfgang Weber-Fahr², Thomas Kuner¹, Johannes Knabbe^{1,3}

Department of Functional Neuroanatomy, Institute for Anatomy and Cell Biology, Heidelberg University, Im Neuenheimer Feld 307, 69120, Heidelberg, Germany.¹

Translational Imaging Research Group, Central Institute of Mental Health, Medical Faculty of Mannheim, Heidelberg University, J5, 68159, Mannheim, Germany.²

Center for Psychosocial Medicine, Department of General Psychiatry, Heidelberg University Hospital, Voßstraße 4, 69120, Heidelberg, Germany.³

Chronic pathological pain, persistent beyond the expected healing time, lacks the vital necessity as a warning symptom for acute danger and affects mostly women¹. It is reportedly accompanied by altered brain gray matter volume (GMV). GMV changes are believed to play a role in the pathophysiology of chronic pain, especially, as magnetic resonance imaging (MRI) studies of humans and rodent models have shown reversibility after successful treatment of chronic pain^{2,3,4}. Still, the physical and cellular basis of structural alterations in chronic pain states and the causal link have largely remained elusive.

At large, the project aims to investigate the cellular mechanisms of GMV changes triggered by chronic pain by correlating MRI with two-photon in vivo imaging (2Pii) in female mice. By comparing the data with a previous study using male mice, the study intends to examine sex-specific differences in pain perception.

The longitudinal study design allowed us to observe the whole chronic pain development. In addition, we were able to validate behavioral changes after induction of chronic pain by showing allodynia, which we correlated with cellular changes. To detect cytoarchitectonic alterations, we performed automated image analysis to segment nuclei and classify cell types based on morphological characteristics gained from 2Pii data⁵. Then, we correlated the cytoarchitectonic parameters with alterations of GMV, measured by voxel-based morphometry⁶. By three-dimensional registration, we mapped cellular volumes from 2Pii stacks onto the respective MRI space. This cross-modal registration enabled us to investigate how defined neocortical volume changes are reflected on a cellular scale.

With this, the study aims to contribute to understanding key mechanisms of structural brain alterations during chronic pain and sex-specific influences.

1. Ruau, D., Liu, L. Y., Clark, J. D., Angst, M. S., & Butte, A. J. Sex differences in reported pain across 11,000 patients captured in electronic medical records. *J Pain*, 13, 228–234, doi: 10.1016/j.jpain.2011.11.002 (2012).
- 2.

- Seminowicz D. A., Wideman T. H., Naso L., et al. Effective treatment of chronic low back pain in humans reverses abnormal brain anatomy and function. *J Neurosci* 31, 7540-7550, doi: 10.1523/JNEUROSCI.5280-10.2011 (2011).
3. Seminowicz, D. A., Laferriere, A. L., Millicamps, M., Yu, J. S., Coderre, T. J., & Bushnell, M. C. MRI structural brain changes associated with sensory and emotional function in a rat model of long-term neuropathic pain. *NeuroImage* 47, 1007–1014, doi: 10.1016/j.neuroimage.2009.05.068 (2009).
 4. Bilbao, A., Falfán-Melgoza, C., Leixner, S., Becker, R., Singaravelu, S. K., Sack, M., Sartorius, A., Spanagel, R., & Weber-Fahr, W. Longitudinal Structural and Functional Brain Network Alterations in a Mouse Model of Neuropathic Pain. *Neuroscience*, 387, 104–115, doi: /10.1016/j.neuroscience.2018.04.020 (2018).
 5. Das Gupta, A., Asan, L., John, J., Beretta, C. A., Kuner, T., & Knabbe, J. Comprehensive monitoring of tissue composition using in vivo imaging of cell nuclei and deep learning. *BioRxiv*, 2022.10.03.510670, doi: <https://doi.org/10.1101/2022.10.03.510670> (2022 preprint).
 6. Asan, L., Falfán-Melgoza, C., Beretta, C. A., Sack, M., Zheng, L., Weber-Fahr, W., Kuner, T., & Knabbe, J. Cellular correlates of gray matter volume changes in magnetic resonance morphometry identified by two-photon microscopy. *Scientific reports*, 11, 4234, doi: 10.1038/s41598-021-83491-8 (2021).

NG2 glia-specific Kir4.1 knockout as a tool to understand the impact of neuron-glia synaptic signaling

Gerald Seifert¹, Dario Tascio¹, Ronald Jabs¹, Aline Timmermann¹, Anne Boehlen¹, Magdalena Skubal¹, Catia Domingos¹, Wenhui Huang³, Frank Kirchhoff³, Christian Henneberger^{1,2}, Andras Bilkei-Gorzo⁴, Christian Steinhäuser¹

¹University of Bonn, Institute of Cellular Neurosciences, Venusberg-Campus 1, 53127 Bonn, Germany

²German Center for Neurodegenerative Diseases (DZNE), Bonn, Germany

³University of Saarland, Molecular Physiology, CIPMM, Homburg, Germany

⁴University of Bonn, Institute of Molecular Psychiatry, Bonn, Germany

NG2 glia in grey matter receive direct synaptic input from glutamatergic and GABAergic neurons, but the functional consequences of this input are not yet understood. During development, NG2 glia upregulate Kir4.1 channels, leading to a low membrane resistance and a resting potential close to the K⁺ equilibrium potential. To test if Kir currents regulate the efficiency of synaptic activation of NG2 glia, we used NG2-CreERT2 knock-in mice to selectively ablate the Kir4.1 gene upon tamoxifen administration. Electrophysiological, molecular, morphological and behavioral consequences were subsequently characterized.

In tamoxifen-treated mice, semi-quantitative RT-PCR of FAC sorted hippocampal NG2 glia revealed a downregulation of Kir4.1 mRNA by 87%. NG2 glia with deleted Kir4.1 lacked Kir currents, were depolarized and displayed an increased membrane resistance compared to the controls. Moreover, the ko cells showed enhanced mPSP amplitudes with delayed activation and inactivation kinetics. Similarly, rise and decay time of mPSCs were prolonged while mPSC amplitudes remained unchanged in Kir4.1 ko vs. control cells. In the novel object location recognition test, an approach testing spatial memory, Kir4.1 ko mice performed better than the controls while no differences were found regarding spatial and social memory. These results led us to investigate the impact of Kir4.1 deletion in NG2 glia on neural signaling. Field potentials were recorded in the hippocampus after stimulation of Schaffer collaterals. Long term potentiation (LTP), induced by theta-burst stimulation, was significantly impaired in the hippocampal CA1 region of mice with NG2 glia-targeted Kir4.1-deficiency. Application of a BDNF analogue activating TrkB receptors rescued LTP, hinting at a role of NG2 glia in the regulation of BDNF-TrkB receptor mediated LTP induction. Expansion microscopy uncovered increased MBP levels in the hippocampus of mice with NG2 glia-targeted deletion of Kir4.1. These findings show that Kir4.1 channels in NG2 glia not only regulate their excitability, but also influence myelination and are important for proper hippocampal synaptic plasticity and behavior.

Supported by DFG (Priority Program 1757, STE 552/5, SE 774/6)

OPCs shape the medial prefrontal cortical inhibition by regulating interneuron apoptosis and myelination employing GABA_B receptor

Lipao Fang¹, Na Zhao¹, Laura C Caudal¹, Renping Zhao², Ching-Hsin Lin³, Hsin-Fang Chang³, Nadine Heinz⁴, Carola Meier⁴, Wenhui Huang¹, Anja Scheller¹, Frank Kirchhoff¹, Xianshu Bai¹

¹Molecular Physiology, CIPMM, University of Saarland, 66421 Homburg, Germany

²Biophysics, CIPMM, University of Saarland, 66421 Homburg, Germany

³Cellular Physiology, CIPMM, University of Saarland, 66421 Homburg, Germany

⁴Department of Anatomy and Cell biology, University of Saarland, 66421 Homburg, Germany

Cortical neural circuits are complex but very precise networks of balanced excitation and inhibition (E/I). Yet, the molecular and cellular mechanisms that form the E/I balance are just beginning to emerge. Stimulated by the large body of evidence on the inhibitory transmitter GABA and myelination for proper neural circuit function, we investigated the role of the metabotropic GABA_B receptor (GABA_BR) in oligodendrocyte precursor cells (OPCs). Using NG2-CreERT2 knock-in mice we selectively ablated the floxed *gabbr1* gene specifically in OPCs and their progeny (cKO), i.e. oligodendrocytes. In the mPFC of cKO mice, the myelination of PV+ interneurons was decreased, and associated with a suppressed firing rate, as shown by vGAT, cFos immunostaining and electrophysiological analysis of the cKO mPFC. Surprisingly, we found an interneuron hypoactivity also we detected a surplus of this celltype. This observation we could explain by a reduced TWEAK (TNF-like weak inducer of apoptosis, Apo3l) release from cKO OPCs during development. Concomitantly, the physiological and morphological changes caused a severe deficit in social cognitive behavior of mutant mice. In summary, our findings uncover a bidirectional communication pathway between interneurons and OPCs. During development, OPCs sense GABA via GABA_BR and release TWEAK to optimize interneuron density and function, which is pivotal for proper interneuron myelination and network function in mPFC.

Quantification of cellular Na⁺ employing rapidFLIM in the mouse hippocampus

Jan Meyer¹, Karl W. Kafitz¹, Christine R. Rose¹

¹ Institute of Neurobiology, Heinrich Heine University Düsseldorf, Universitätsstraße 1, 40225 Duesseldorf, Germany

Excitatory brain activity induces intracellular Na⁺ transients which are especially large in fine cellular processes. Up to now, changes in intracellular Na⁺ concentration ([Na⁺]_i) were usually evaluated using intensity-based imaging with fluorescent Na⁺ indicator dyes. Intensity-based imaging, however, is prone to artifacts induced by differences and/or changes in dye concentration. This might be problematic when comparing different cellular compartments and can interfere with a proper quantitative analysis of ion concentrations and transients. Employing fluorescence lifetime imaging microscopy (FLIM) circumvents this pitfall because of its independence of the concentration of the fluorophore. Up to now however, the analysis of fluorescent lifetime images often required long collection times (many tens of seconds to around one minute) to yield enough photons for stable fitting conditions. This is especially critical for fluorophores with low quantum yields such as the available chemical indicators for intracellular Na⁺ and Cl⁻. The recent introduction of rapidFLIM has overcome this limitation, enabling much higher possible photon counts and a more sensitive detection of available photons. Compared to previously utilized techniques, rapidFLIM thereby greatly improves temporal resolution. The latter is particularly important for recording of rapid and often spatially constrained transient intracellular changes that are of interest in a typical neurobiological experiment.

In this study, we utilized rapidFLIM for imaging of [Na⁺]_i in the mouse hippocampus using the chemical indicator dye ION-NaTRIUM-Green-2 (ING2). We show that rapidFLIM enables quantitative imaging of [Na⁺]_i in astrocytes and pyramidal neurons in tissue slice preparations. Application of glutamatergic agonists like D-Aspartate or perfusion of slices with altered extracellular K⁺ evoke changes in [Na⁺]_i in both cell types that can be dynamically recorded using rapid FLIM. We conclude that rapidFLIM permits the spatiotemporal quantification of ion transients using dim fluorophores independent from differences in intra- and intercellular dye concentration. Furthermore, it will enable a more sensitive detection of a wide range of dynamic signals with other fluorescent probes, most notably those with intrinsic low photon emission.

Supported by the DFG (FOR2795 “Synapses under stress”, Ro2327/13-2).

Role of hevin in drug addiction

Vincent Vialou¹

¹INSERM, Neuroscience Paris Seine - Sorbonne Université, 9 quai saint bernard, Sorbonne Université, Bat. B, p429, 75005 Paris, France

Astrocytic-secreted matricellular proteins have been shown to influence various aspects of synaptic function and more recently in animal models of psychiatric disorders such as drug addiction. Hevin, a matricellular protein highly expressed in the adult brain, has been implicated in resilience to stress and antidepressant treatment suggesting a role in motivated behaviors.

To address the possible role of hevin in drug addiction, we used RNA interference strategy to downregulate hevin, chemogenetics to manipulate the activity of astrocytes, and calcium signals fiber photometry in mouse experiencing drugs of abuse and in vitro models to study the mechanism of action of hevin.

These complementary approaches give a comprehensive understanding of the role of hevin in the adult brain.

Serotonin1A-Receptor mediated signaling in Astrocytes and its influence on depression-like behavior

Svenja Bremshey^{1,2}, Michael Koch², Olivia A. Masseck¹

¹Synthetic Biology, University of Bremen, Leobener Str. 5, 28359 Bremen, Germany

²Neuropharmacology, University of Bremen, Hochschulring 18, 28359 Bremen, Germany

Worldwide Depression is one of the most common psychiatric disease with more than 200 million affected people. Most of the research on depression is focused on the interaction between neurons. However recent studies suggest a greater role of non-neural cells within the nervous system, such as astrocytes, than previously thought. To date there is much evidence of a bidirectional communication between astrocytes and neurons, especially at the synapse. Astrocytes by itself are capable to release gliotransmitter and in turn modulate neurons.

Although the involvement of serotonin (5-HT) in the development and manifestation of depression is hypothesized since many decades, the exact mechanism which lead to the manifestation of depression are poorly understood. Several studies point to an involvement of astrocytes in depression and other affective disorders.

Astrocytes express different 5-HT-Receptors, among other also the 5-HT1A-R, which is a treatment target for anxiety and depressive disorders. Our study investigates the influence of 5-HT1A-Receptor mediated signaling in astrocytes on depressive-like symptoms. In neurons, the 5-HT1A-Receptor is coupled to the Gi pathway. Interestingly, in astrocytes Gi coupled Receptors can induce internal calcium elevation. To test if this applies also to the 5-HT1A-Receptor we first preformed Calcium Imaging in acute brain slices in the mouse medial prefrontal cortex (mPFC). Pharmacological activation of the 5-HT1A-Receptor led to an significant increase of Calcium Events in astrocytes. We hypothesize that 5-HT1A mediated calcium increase in astrocytes of the mPFC will release gliotransmitter and could mediate antidepressant effects. To proof our hypothesis we preformed optogenetic behavioral tests with a light activatable 5HT1A-Receptorchimera (Masseck et al. 2014). To investigate the social component of depression the chronic social defeat stress test was used. The 5-HT1A-Receptor signalling pathways were activated during acute stress exposure. To examine anhedonia a second model, the chronic mild stress test was used. Here, 5-HT1A signaling pathways in astrocytes were activated during the second half of the chronic stress paradigm. Our behavioral data indicate antidepressant effects mediated by the specific activation of 5-HT1A signaling pathways in medial prefrontal cortex astrocytes.

The axonal vesicle release machinery and myelination

Julia Wolf¹, Silvia Cases-Cunillera², Susanne Schoch², Dirk Dietrich¹

¹Department of Neurosurgery, University Hospital Bonn, 53127 Bonn, Germany

²Department of Neuropathology, University Hospital Bonn, 53127 Bonn, Germany

Myelination of axons, necessary for saltatory conduction of action potentials, requires the development of mature oligodendrocytes from oligodendrocyte precursor cells, also called NG2 cells, which can be newly generated at any stage of the central nervous system (CNS) development. It has been suggested that myelin formation is plastic and might be regulated by neuronal activity, for example during learning and memory. Neurons directly communicate with NG2 cells via synapses which are functionally and structurally similar to classical synapses between neurons. NG2 cells express glutamate receptors and voltage-gated ion channels and are able to transform synaptic input into intracellular calcium signals. However, whereas several studies have addressed the relevance of postsynaptic signal processing in NG2 cells, the role of neuronal glutamate release on myelination is still not fully elucidated.

Here, we bi-directionally manipulated axonal neurotransmitter release by targeting, components of the presynaptic release machinery. To this end, we introduced plasmids expressing specific shRNAs, mutated proteins and Tetanus toxin into excitatory neurons in layer II/III of the cortex WT mice at E14.5 by in utero electroporation. These mice were then perfused at distinct postnatal time points and coronal brain slices were prepared for analysis of myelination by electron microscopy via immunogold labelling against the aforementioned DNA.

At an early postnatal timepoint of preparation various parameters of myelination, such as myelin thickness, g-ratios, axon diameter and number of myelinated axons, seem not to be affected by the first set of introduced plasmids. However, at this timepoint only a small number of axons is myelinated. Effects might differ at a later developmental timepoint, at which myelination in the corpus callosum reaches its peak. This possibility as well as potential effects of targeting other components of the presynaptic release machinery are still being investigated.

The impact of synaptic signaling activity on hippocampal microglia

Frederieke Sophie Moschref¹, Nils Brose¹, Benjamin H. Cooper¹

¹Max Planck Institute for Multidisciplinary Sciences, Department of Molecular Neurobiology, Hermann-Rein-Strasse 3, 37075 Göttingen, Germany

Dynamic changes in synaptic connectivity are essential for brain development, for the developmental establishment of neuronal circuits, and for circuit plasticity in the mature brain. Key aspects of synaptic plasticity are linked to microglia, which are well known as the brain-resident immune cells. Aside from their role in pathology, MG were recently identified to be able to sense and respond to neuronal activity in a physiological state of the brain¹. Our research is aimed at understanding the as yet poorly understood modes of neuron-microglia communication during activity-dependent circuit plasticity.

Our working hypothesis is that microglia are regulated by presynaptic release of neurotransmitters and other signalling molecules, and act, in response, upon neuronal circuits. To address this hypothesis, we are using hippocampal organotypic slice cultures from synaptic secretion-deficient Munc13-1/2 DKO² and control mice, combined with pharmacological manipulations, to examine microglial responses to global ablation, or hyperactivation, of synaptic neurotransmission. The hippocampal organotypic slice culture preparation³ is well suited for this purpose as it reproduces in vivo-like microglial characteristics⁴ and is compatible with the analysis of perinatally lethal mutant phenotypes. We focus our analyses initially on microglial morphology, which changes from a ramified surveying to an amoeboid phagocytic phenotype upon activation⁵, by visualizing enhanced green fluorescent protein (EGFP) expressed under microglial-specific promoter. To this end we have bred CX3CR1-EGFP⁶ mice into a Munc13-deficient background. Microglial morphology is reconstructed at the cellular level using confocal light microscopy, and quantified via systematic automatic image analyses⁷. Ultimately, we aim to extend our findings beyond the perturbation of neurotransmission, by conducting complementary experiments using Rab3ABCD QKO mice⁸, to study the influence of neuronal factors (e.g., neuropeptides, growth factors) secreted from large dense-core vesicles on microglial activity states.

¹Li and Barres (2017) Nat Rev Immunol 18, 225. ²Sigler et al (2017) Neuron 94, 304. ³Stoppini et al (1991) J Neurosci Methods 37, 173. ⁴Delbridge et al (2020) Front Cell Neurosci 14, 592005. ⁵Nimmerjahn et al (2005) Neuroforum 11, 95. ⁶Jung et al (2000) Mol Cell Biol 20, 4106. Science. ⁷Heindl et al (2018) Front Cell Neurosci 12, 106. ⁸Persoon et al (2019) Neuron 104, 1065.

The synaptic vesicle protein Mover/TPRG1L is associated with lipid droplets in astrocytes

Jeremy Krohn¹, Florelle Domart², Thanh Thao Do², Thomas Dresbach²

¹German Center for Neurodegenerative Diseases (DZNE), Charité Campus Mitte, 10117 Berlin, Germany

²Institute of Anatomy and Embryology, University Medical Center Göttingen, Georg-August University of Göttingen, 37075 Göttingen, Germany

Crucial brain functions such as neurotransmission, myelination, and signaling pose a high demand for lipids. Lipid dysregulation is associated with neuroinflammation and neurodegeneration. Astrocytes protect neurons from lipid induced damage by accumulating and metabolizing toxic lipids in organelles called lipid droplets (LDs). LDs have long been considered as lipid storage compartments in adipocytes, but less is known about their biogenesis and composition in the brain. In particular, proteins covering the LD surface are not yet fully identified.

Here, we report that the synaptic vesicle protein Mover/TPRG1L, which regulates the probability of neurotransmitter release in neurons, is a component of the LD coat in astrocytes. Using conventional and super resolution microscopy, we demonstrate that Mover surrounds naive and oleic acid induced astrocytic LDs. We confirm the identity of astrocytic LDs using the neutral lipid stains Bodipy and LipidTox, as well as immunofluorescence for perilipin-2, a known component of the LD coat. In astrocytes, recombinant Mover was sufficient to induce an accumulation of LDs. Furthermore, we identified point mutations that abolish targeting to LDs and show similarities in the required binding sequences for association to the presynapse and LDs.

Our results show that Mover is not only a presynaptic protein but also a candidate for LD regulation. This highlights the dual role of Mover in synaptic transmission and regulation of astrocytic LDs, which may be particularly important in the context of lipid-related neurological disorders.

Viral approaches to elucidate the function of different tanycytic subpopulations

Vanessa Neve¹, Helge Müller-Fielitz¹, Frauke Spiecker¹, Anke Fähnrich², Ruben Nogueiras³, Vincent Prevot⁴, Markus Schwaninger¹

¹University of Lübeck, Institute for Experimental and Clinical Pharmacology and Toxicology, Ratzeburger Allee 160, 23562 Lübeck, Germany

²University of Lübeck, Group for Medical Systems Biology, Ratzeburger Allee 160, 23562 Lübeck, Germany

³University of Santiago de Compostela, Center for Research in Molecular Medicine and Chronic Diseases, Av. Barcelona, 15782 Santiago de Compostela, Spain

⁴University of Lille, Development & Plasticity of the Neuroendocrine Brain, 1 Place de Verdun, 59045 Lille cedex, France

The third ventricle in the region of the hypothalamus is lined by specialised glia-like cells called tanycytes. Their processes reach into different nuclei of the mediobasal hypothalamus and median eminence (ME) responsible for energy homeostasis, food intake, hormone release, and other vital functions. Historically tanycytes are distinguished by their morphology and location along the ventricle. The classical beta-tanycytes, located in the median eminence (ME) and the lateral protrusions, have projections into the arcuate nucleus (ARH) and the ME. Characteristic of the ME are the fenestrated vessels, which means that the blood-brain-barrier is open. It has already been shown, that tanycytes take over the barrier-function by tight junctions and control thereby the exchange of substances between brain and periphery and regulating the hormone release. On the other hand, it is discussed that the alpha-tanycytes, extending from the ARH to the ventromedial- (VMH) as well as dorsomedial (DMH) nucleus, regulate feeding behaviour. However, the classification according to localisation alone does not provide information about the function of subpopulations. In the past, we have used an adeno-associated virus (AAV)-based approach to target all tanycytes. To target specific subpopulations, we have now used small promoter fragments of differentially expressed genes driving a Cre-recombinase combined with a green fluorescent marker (GFP). These AAVs were injected into the lateral ventricle of Ai14 reporter mice by stereotactic surgery. By immunofluorescence staining we analysed the transduction pattern of vectors harbouring up to 19 different promoter sequences. Using this approach, we were able to identify promoters that are very specific for tanycytic subpopulations. With this new tool we were able to further investigate the function and connectivity of subpopulations. Neurons from specific brain areas like the paraventricular nucleus extend axons through the mediobasal hypothalamus and the ME and are therefore in close proximity to tanycytes. It has already been shown by electron microscopy that the endfeet of the tanycytic processes are in contact with neurons. However, with our subpopulation specific AAVs and additional viral tools we found evidence that neurons have synaptoid contacts with tanycytes. Specific neurons appear to be in contact only with individual subpopulations of tanycytes. To support the functionality of the synaptoid contacts we detected intracellular calcium or cAMP levels in living slices using GCaMP and Flammindo2, respectively. With these viral approaches, we are able to further breakup the historical classification and unveil the function of individual tanycytes.

Wrapping glia influence on larval reorientation

Marit Praetz¹, Christian Klämbt¹

¹University of Muenster, Institute for Neuro- and Behavioral Biology, Badestraße 9, 48149 Muenster, Germany

Proper neuronal function requires extensive glial contributions. To decipher how peripheral wrapping glial cells contribute to the motor program underlying locomotion we study larval locomotion in *Drosophila*. The crawling trajectory of *Drosophila* larvae is characterized by two distinct states. During larval locomotion, go phases are interrupted by reorientation phases characterized by reduced locomotion velocity and intensive head sweeping. During this phase sensory organs probe local information to determine the direction of the successive run. We observed different strategies of reorientation. Firstly, a straight crawl - stop - head sweep - reorientation followed by a straight crawl. Secondly, a clockwise or counter clockwise circling of the area. In addition, we have previously defined an extreme state within the reorientation phase called coiling. Here, the larvae perform a body bending with an angle of more than 120°. This body posture is detected in a low frequency in wild type larvae but occurs frequently in the absence of wrapping glial cells, suggesting that posture is induced by ephaptic coupling. Further characterization shows that the coiling phenotype represents a neuronally hard-wired reorientation locomotor feature. Thus, glial cells are normally in place to reduce the signalling threshold inducing coiling. Interestingly, we find differences in the reorientation phases of different wild type strains as well as within different individual larvae of one isogenic background. Further mutant and wild type strains will be tested in behavioural assays to dissect the individual strategies larvae use to reorient.

Poster Topic

T10: Aging and Developmental Disorders

- [T10-1A](#) Characterisation of murine L6b and its role in manifestation of ASD associated behaviour.
Aasha Meenakshisundaram, Timothy Zolnik, Britta Eickholt, Zoltán Molnár
- [T10-2A](#) Cognitive flexibility and frontal theta: effects of ageing
Margarita Darna, Christopher Stolz, Constanze I. Seidenbecher, Björn H. Schott, Anni Richter
- [T10-4A](#) Dietary spermidine protects from age-related synaptic alterations while inducing neuronal autophagy and NPY in the aging brain
Marta Maglione, Gaga Kochlamazashvili, David Toppe, Giovanna Cazzolla, Volker Haucke, Stephan Sigrist
- [T10-5A](#) EphrinA5 regulates neuronal migration by repressing the long non-coding RNA *Snhg15* and perturbing its interactions with DNA methyltransferase 1
Can Bora Yildiz, Jannis Koesling, Julia Reichard, Philip Wolff, Julia Gehrman, Ivan G. Costa, Mira Jakovcevski, Daniel Pensold, Geraldine Zimmer-Bensch
- [T10-1B](#) Gene therapy targeting brain endothelial cells improves neurological symptoms in a model of genetic MCT8 deficiency
Adriana Arrulo Pereira, Sivaraj M. Sundaram, Helge Müller-Fielitz, Hannes Köpke, Meri De Angelis, Timo D. Müller, Heike Heuer, Jakob Körbelin, Markus Krohn, Jens Mittag, Ruben Nogueiras, Vincent Prevot, Markus Schwaninger
- [T10-2B](#) In vivo optogenetic inhibition of striatal parvalbumin-reactive interneurons induced genotype-specific changes in neuronal activity without dystonic signs in DYT1 knock-in mice
Anja Schulz, Franziska Richter, Angelika Richter
- [T10-3B](#) Increase in Vascular Bag Numbers in the White Matter of the Human Brain with Aging but not in Alzheimer's Disease
Deniz Yilmazer-Hanke, Kameliya S. Georgieva, Najwa Ouali Alami
- [T10-4B](#) Inhibitory temporo-parietal effective connectivity is associated with explicit memory performance in older adults
Björn Hendrik Schott, Joram Soch, Jasmin Kizilirmak, Anni Richter
- [T10-5B](#) Is Rett syndrome associated with brain regional alterations in mitochondrial density and neuronal redox status?
Laura van Agen, Michael Müller

- [T10-6B](#) Developmental changes in the electrophysiological properties of pyramidal neurons in the auditory cortex of the *Cntnap2* KO rat model of Autism Spectrum Disorder.
Rajkamalpreet S. Mann, Brian L. Allman, Susanne Schmid
- [T10-1C](#) Multi-modal epigenetic changes and altered NEUROD1 chromatin binding in the mouse hippocampus underlie FOXP1 syndrome
Ipek Akol, Annalisa Izzo, Thomas Manke, Tanja Vogel
- [T10-2C](#) Multiple facets of heterozygous FOXP1 loss on neural development and FOXP1 syndrome outcome in different patient-specific backgrounds
Fabian Gather, Ipek Akol, Analia Rojas Caballero, Christos Galanis, Andreas Vlachos, Tanja Vogel
- [T10-3C](#) Pathophysiological and structural consequences of novel mutations in the asparagine synthetase gene (ASNS) associated with microcephaly
Dorit John, Ulrike Winkler, Tabea Junge, Maximilian Liebmann, Anja Reinert, Susanne Köhler, Johannes Hirrlinger
- [T10-4C](#) TOGARAM1 mutation in spina bifida highlights alternative mechanisms in neural tube closure defects
YANYAN WANG, Nadine Krämer, Olaf Ninnemann, Joanna Schneider, Li Na, Hao Hu, Shyamala Mani, Angela Kaindl
- T10-5C Retracted
- [T10-6C](#) Cell type - specific functions of the DNA methyltransferase 1 in cortical interneuron development
Julia Reichard, Jenice Reimara Nicola Linde, Can Bora Yildiz, Georg Pitschelatow, Geraldine Zimmer-Bensch

Characterisation of murine L6b and its role in manifestation of ASD associated behaviour.

Aasha Meenakshisundaram^{1,2}, Timothy Zolnik³, Britta Eickholt^{1,2}, Zoltán Molnár⁴

¹Institute for Biochemistry, Charite – Universitätsmedizin Berlin, 10117 Berlin, Germany

²Charite – Universitätsmedizin Berlin, Einstein Center for Neurosciences, 10117 Berlin, Germany

³Institute for Biology, Humbolt-Universität zu Berlin, Germany

⁴Department of Physiology, Anatomy and Genetics, University of Oxford, Oxford OX1 3QX, UK

Layer 6b (L6b) is the deepest layer of cortex, which arises during development from the cortical subplate. The subplate consists of specific subpopulations of neurons, which contribute to the establishment of thalamocortical and corticocortical networks early in neocortical development. L6b drives cortical activity via its projections to the higher order thalamus, cortical layers 1 and 5. Aberrant development of L6b may alter the cortical circuitry and activity, resulting in manifestation of Autism Spectrum Disorder (ASD) associated behavioural phenotypes. Autistic individuals have been observed to possess a higher number of persistent L6b neurons. These neurons also show increased dendritic arborization and spine density, a morphological feature observed on the modulation of PTEN. PTEN is a tumor suppressor gene, which regulates neuronal survival and morphology by modulation of growth factor/ PI3K signalling. Here, we studied a mouse line carrying the conditional deletion of PTEN in L6b specific *Drd1* neurons. Confocal microscopy of coronal sections of these mouse brains indicate a distinct increase in the number of *Drd1* neurons persisting into adulthood in the PTEN deficient condition. There is also a PTEN dependent variation in the cell size and dendritic arborisation of pyramidal *Drd1* neurons. Whole-cell patch clamp recordings show a dose-dependent difference in the excitability of these neurons. Given the potential association of subplate in autism, we hypothesised that the change in the morphology and physiology of *Drd1* neurons would result in ASD-associated behavioural deficits. We therefore examined several autism-associated behaviours in PTEN deficient mice. We found that the PTEN deficient mice did not express abnormal behaviours in any of our tests evaluating for sociability, sensitivity to various sensory stimuli, anxiety, learning and memory. We speculate that the PTEN deficient *Drd1* neurons either play a role in an untested behavioural phenotype, or in compensatory mechanisms which have re-established a normal behavioural phenotype in these mice.

Cognitive flexibility and frontal theta: effects of ageing

Margarita Darna¹, Christopher Stolz¹, Constanze I. Seidenbecher¹, Björn H. Schott^{1,2,3},
Anni Richter¹

¹Leibniz Institute for Neurobiology (LIN), Magdeburg, Germany

²German Center for Neurodegenerative Diseases (DZNE), Göttingen, Germany

³ Department of Psychiatry and Psychotherapy, University Medical Center Göttingen, Göttingen, Germany

Cognitive flexibility is described as a person's ability to adapt their behaviour in a changing environment. Previous studies showed that frontal theta oscillations recorded with electroencephalography (EEG) are associated with cognitive control processes such as cognitive flexibility and that cognitive flexibility diminishes with age. However, the ageing effects on frontal theta during set-shifting are yet widely unknown. The attentional set-shifting task (ASST) is a prominent task to examine cognitive flexibility in humans, as it includes trials where the rules change from one trial to another (shift trials) or remain the same (control trials). In order to investigate frontal theta responses to set-shifting separated from post-feedback adjustments, we assessed EEG during a modified version of the ASST that excludes feedback information. Our goal was to determine 1) whether frontal theta is associated with set-shifting and 2) whether these effects differ between young and older adults. In total, 20 young (age: 22.5 ± 2.9 years) and 20 older (age: 69.3 ± 5.9 years) adults were evaluated. Time-frequency analyses revealed amplified frontal theta power (4-8 Hz) in young adults with increasing shift difficulty 250 to 500 ms after stimulus presentation. In contrast, frontal theta power was overall decreased in older vs. young adults and we did not find significant set-shifting effects on frontal theta power in older adults. Overall, our study provides novel evidence supporting the notion of frontal theta alterations as a potential biomarker for diminished cognitive flexibility in ageing.

Dietary spermidine protects from age-related synaptic alterations while inducing neuronal autophagy and NPY in the aging brain

Marta Maglione^{1,2}, Gaga Kochlamazashvili³, David Toppe¹, Giovanna Cazzolla¹, Volker Haucke^{1,2,3}, Stephan Sigrist^{1,2}

¹Freie Universität Berlin, Department of Biology, Chemistry, Pharmacy, Takustr. 6, 14195 Berlin, Germany

²NeuroCure Cluster of Excellence, Charité Universitätsmedizin, Charitéplatz 1, 10117 Berlin, Germany

³Department of Molecular Pharmacology and Cell Biology, Leibniz Forschungsinstitut für Molekulare Pharmakologie (FMP), Robert-Rössle-Str. 10, 13125 Berlin, Germany

Aging is a major risk factor driving memory impairment (AMI), often a prelude of severe neurodegenerative diseases. Understanding the cellular and molecular mechanisms underlying cognitive brain aging is thus fundamental for developing protective therapies.

Neurons are long lived, terminally differentiated cells no longer able to undergo cell division. Thereby their functionality and protein composition need to be properly controlled through the whole lifetime of a given organism, in particular during aging. Autophagy, a cellular degradation pathway, is considered to be a major pathway for the removal of defective proteins and organelles in order to maintain proper neuronal function. We previously demonstrated that dietary supplementation with the natural polyamine spermidine, a physiological autophagy inducer, protects from presynaptic alterations and rescues AMI in *Drosophila melanogaster*. Similarly, dietary spermidine supplementation, meant to mimic calorie restriction, protected hippocampal autophagy and prevented age-associated structural and synaptic plasticity changes at murine hippocampal mossy fiber-CA3 synapses, a type of synapse executing plasticity via presynaptic mechanisms as *Drosophila* synapses.

Concerning signaling processes relevant in this context, NPY, the most abundant neuropeptide in the brain, being predominantly produced in the hypothalamus, is a prime candidate a mediator of the anti-aging beneficial effects of caloric restriction. Importantly, impairing autophagy exclusively in the Mushroom Body, *Drosophila* learning center, but not in other brain regions, triggered changes normally restricted to aged brains, resulting in impaired memory as well as a brain-wide presynaptic upscaling in a non-cell autonomous manner via the NPY family peptide sNPF. In the mammalian brain, the hypothalamus seemingly operates as master regulator of whole-body metabolism, in controlling systemic aging, longevity and age-related cognitive decline. However, how the interplay between neuronal autophagy and NPY intersects with neuronal processes mediating brain maintenance and aging remains to be explored.

Our preliminary work presented here suggests that systemic “anti-aging” interventions, such as dietary spermidine, might ultimately act via restoring proper hypothalamic function by increasing NPY and autophagy in aged mice.

EphrinA5 regulates neuronal migration by repressing the long non-coding RNA *Snhg15* and perturbing its interactions with DNA methyltransferase 1

Can Bora Yildiz^{1,2}, Jannis Koesling¹, Julia Reichard^{1,2}, Philip Wolff¹, Julia Gehrman³, Ivan G. Costa³, Mira Jakovcevski¹, Daniel Pensold¹, Geraldine Zimmer-Bensch^{1,2}

¹Department of Neuroepigenetics, Institute for Biology II, RWTH Aachen University, Aachen, Germany

²Research Training Group 2416 MultiSenses-MultiScales, RWTH Aachen University, Aachen, Germany

³Institute for Computational Genomics, Faculty of Medicine, RWTH Aachen University, Aachen, Germany

Intracellular communication is imperative for several processes underlying proper brain development such as neuronal migration. Widely accepted, epigenetic mechanisms are essential in the integration of external stimuli emanating from neighboring cells into the genome by regulating the expression of genes causal for physiological responses. The interaction of membrane-bound Eph receptors with their associated ligands, the ephrins, and the ensuing bidirectional signaling have been reported to regulate neuronal migration via cytoskeletal remodeling. Consequently, abnormal expression or disturbed signaling of members of the Eph/ephrin family, including EphA2 and ephrinA5, have been implicated in several central nervous system diseases, including amyotrophic lateral sclerosis (ALS) and brain tumors such as glioblastoma and medulloblastoma. Albeit having been investigated in many studies throughout the recent years, whether and how Eph/ephrin signaling can alter gene expression, underlying physiological responses, is yet to be deciphered. In our previous work with cerebellar granule (CB) cells, we were able to detect ephrinA5-induced changes in the expression of both protein-coding genes as well as long non-coding RNAs (lncRNAs) such as *Snhg15*. As lncRNAs can function as adapters for epigenetic modifiers, here, we investigated whether ephrinA5 regulates the motility of CB cells by modulating the expression of migration-related genes through a differential expression of *Snhg15* and consequent alterations in epigenetic mechanisms. We found an ephrinA5-induced reduction in the interaction between *Snhg15* and DNMT1, a DNA methyltransferase that catalyzes DNA methylation, an epigenetic mechanism often associated with gene repression. This finding was concomitant with a decreased enrichment of DNMT1 as well as reduced DNA methylation levels in the *Ncam1* promoter, in line with the ephrinA5-triggered increase in *Ncam1* expression and restriction of CB cell motility. Indeed, diminishing the expression of *Ncam1* abolished the ephrinA5-induced motility restriction and restored the migratory capacity of CB cells. Altogether, we propose a potential mechanism of ephrinA5 in the regulation of neuronal migration by interfering with the *Snhg15*-mediated recruitment of DNMT1 to the promoter of *Ncam1*, thus elevating its expression and ultimately reducing CB cell motility. Due to *Snhg15* being termed a driver of tumorigenesis in many cancers and CB cells being a cell line commonly used to model medulloblastoma, these findings might further help to elucidate the role of ephrinA5 as a potential therapeutic against cancer.

Gene therapy targeting brain endothelial cells improves neurological symptoms in a model of genetic MCT8 deficiency

Adriana Arrulo Pereira¹, Sivaraj M. Sundaram¹, Helge Müller-Fielitz¹, Hannes Köpke¹, Meri De Angelis², Timo D. Müller², Heike Heuer³, Jakob Körbelin⁴, Markus Krohn¹, Jens Mittag⁵, Ruben Nogueiras⁶, Vincent Prevot⁷, Markus Schwaninger^{1,8}

¹Universität zu Lübeck, Institut für Experimentelle und Klinische Pharmakologie und Toxikologie, Lübeck, Germany.

²Institute for Diabetes and Obesity, Helmholtz Zentrum Munich, Munich, and German Center for Diabetes Research (DZD), Germany.

³Department of Endocrinology, Diabetes and Metabolism, University Hospital Essen, University Duisburg-Essen, Essen, Germany.

⁴Department of Oncology, Hematology and Bone Marrow Transplantation, UKE Hamburg-Eppendorf, Hamburg, Germany.

⁵Institute for Endocrinology and Diabetes, Center of Brain, Behavior and Metabolism, University of Lübeck, Lübeck, Germany.

⁶Department of Physiology, CIMUS, University of Santiago de Compostela-Instituto de Investigación Sanitaria, Santiago de Compostela, Spain.

⁷Univ. Lille, Inserm, CHU Lille, Laboratory of Development and Plasticity of the Neuroendocrine Brain, Lille Neuroscience & Cognition, UMR-S 1172, European Genomic Institute for Diabetes (EGID), Lille, France.

⁸DZHK (German Research Centre for Cardiovascular Research), Hamburg-Lübeck-Kiel, Germany.

The *solute carrier family 16, member 2 (SLC16A2)* gene is located on the X-chromosome and encodes for the monocarboxylate transporter 8 (MCT8). MCT8 function is to facilitate TH transport across plasma membranes. Inactivating mutations in the gene encoding for MCT8 (*SLC16A2*) results in MCT8 deficiency, clinically described as Allan-Herndon-Dudley syndrome (AHDS). Patients present severe intellectual and motor disabilities, and TH abnormalities. *Mct8/Oatp1c1* DKO mouse model replicates the clinical picture of human MCT8 deficiency and is being used to develop therapeutic strategies for AHDS.

Although thyroid hormone analogues improve peripheral changes of MCT8 deficiency, no treatment of the neurological symptoms is available so far. Therefore, we developed a gene replacement therapy in *Mct8/Oatp1c1* DKO mice. In our study, we show that targeting brain endothelial cells by intravenously injection of AAV-BR1-*Mct8* increased the T3 levels in the brain and ameliorated morphological and functional parameters associated with the disease. This gene replacement therapy also resulted in long-lasting improvement in motor coordination.

Together, our results support the concept that MCT8 mediates the transport of thyroid hormones into the brain and suggests a vascular target that is easily accessible and can help overcome the consequences of the severe disability associated with MCT8 deficiency.

In vivo optogenetic inhibition of striatal parvalbumin-reactive interneurons induced genotype-specific changes in neuronal activity without dystonic signs in DYT1 knock-in mice

Anja Schulz¹, Franziska Richter^{1,2}, Angelika Richter¹

¹Institute of Pharmacology, Pharmacy and Toxicology, Faculty of Veterinary Medicine, University of Leipzig, Germany

²Institute of Pharmacology, Toxicology and Pharmacy, University of Veterinary Medicine Hannover, Germany

Abnormal striatal plasticity in the striatum plays a crucial role in the pathophysiology of dystonia - a movement disorder characterized by sustained or intermittent muscle contractions causing abnormal postures and movements. Evidence from animal models support a loss of inhibition at circuit level and suggest a dysfunction of striatal parvalbumin-reactive interneurons (Parv+) as the main inhibitory input onto striatal projection neurons.

We investigated the effects of a loss of inhibition in the striatum on the development of dystonic signs and changes in neuronal activity in a genetic mouse model of early-onset torsion dystonia (DYT1). Thus, we used *in vivo* optogenetic inhibition of Parv+ in DYT1 knock-in mice (DYT1 KI), which do not show overt dystonia but have subtle sensorimotor deficits and pattern of abnormal synaptic plasticity within the striatal microcircuitry. Optogenetic fibers were bilaterally implanted into the dorsal striatum of DYT1 KI mice and wildtype littermates (wt) expressing halorhodopsin (eNpHR3.0) in Parv+. The chloride ion pump eNpHR3.0 is activated by yellow light, resulting in hyperpolarization of Parv+.

While stimulations with yellow light pulses for up to 60 min did not induce abnormal movements, such as dystonic symptoms, immunohistochemical examinations revealed genotype-related differences in neuronal activity. In contrast to wt mice, stimulated DYT1 KI showed decreased striatal neuronal activity, i.e., less c-Fos reactive neurons, and increased activation of cholinergic interneurons after optogenetic inhibition of Parv+ interneurons.

These findings suggest an involvement of Parv+ interneurons in an impaired striatal network in DYT1 KI mice, but at least optogenetic inhibition of these GABAergic interneurons was not sufficient to trigger a dystonic phenotype.

Increase in Vascular Bag Numbers in the White Matter of the Human Brain with Aging but not in Alzheimer's Disease

Deniz Yilmazer-Hanke¹, Kameliya S. Georgieva¹, Najwa Ouali Alami¹

¹Ulm University, Clinical Neuroanatomy, Neurology, Helmholtzstr. 8/1, 89081 Ulm, Germany

Microvessels in the white matter of the cerebral hemispheres develop vascular bags in the human brain, a novel microvascular pathology discovered in our laboratory, in the presence of cerebrovascular endothelial cell damage. We could previously show that numbers of vascular bags are significantly increased in aging and in subcortical cerebral small vessel disease (sCSVD) with white matter lesions (WML). Interestingly, the so-called normal appearing white matter (NAWM) in sCSVD also exhibits increased vascular bagging compared to control cases. Because patients with Alzheimer's disease (AD) often have mixed vascular pathologies including wide-spread WML leading to mixed dementia, we hypothesized that white matter vascular bagging occurs in the NAWM in AD potentiating retrograde axonal degeneration and contributing to disease pathogenesis.

In the present study, autopsy tissue from a non-selected aged autopsy cohort as well as from age-matched cohort with different stages of Alzheimer-related pathology was used. A mid-hemispheric formalin-fixed tissue block was embedded in polyethylene glycol and 100 µm-thick hemisphere sections were obtained. Vascular bags and endothelial cell recession leading to string vessels were studied by using double-label immunohistochemistry/immunofluorescence for the simultaneous visualization of collagen IV (COLL4)-positive membranous vascular bags and the endothelial cell layer using UEA-I lectin that labels the endothelial glycocalyx. Disturbances of the blood-brain-barrier were studied by assessing leakage of plasma proteins.

Results showed that vascular bagging is a common finding in the white matter of a non-selected aged autopsy cohort and in a second cohort with different stages of Alzheimer-related changes. Quantitative analyses of vascular bagging in the periventricular and deep white matter studied in the temporal and frontoparietal lobes indicated a statistically significant correlation between age and the degree of vascular bagging. Vascular bags in the aged adult human brain also contained leaked plasma proteins as previously shown in sCSVD. Moreover, vascular bagging positively correlated with string vessel formation in the aging cohort suggesting the presence of common mechanisms that trigger the development of both age-related changes. In contrast, vascular bagging studied in the NAWM of the temporal and frontoparietal lobes was not associated with different stages of Alzheimer-related changes.

Our results indicate that age is a risk factor for developing vascular bagging in the periventricular and deep frontoparietal NAWM. However, vascular bagging was not increased in the subcortical NAWM of randomly selected cases with a pathologically confirmed diagnosis of AD. The increase of vascular bagging in aging but not AD suggests that vascular bagging is an independent vascular pathology in the human aged brain.

Inhibitory temporo-parietal effective connectivity is associated with explicit memory performance in older adults

Björn Hendrik Schott^{1,2,3}, Joram Soch², Jasmin Kizilirmak², Anni Richter³

¹University Medical Center Göttingen, Department of Psychiatry and Psychotherapy, von Siebold-Str. 5, 37075 Göttingen, Germany

²DZNE Göttingen, Göttingen, Germany

³Leibniz Institute for Neurobiology, Magdeburg, Germany

In functional magnetic resonance imaging (fMRI) studies, successful encoding of novel information into episodic memory is associated with increased activation of the hippocampus and temporo-occipital cortical structures like the parahippocampal place area (PPA), as well as decreased activations of midline brain structures like the precuneus. Older adults typically exhibit lower memory performance, which is accompanied by attenuated activations and deactivations. It is, however, yet unclear how the hippocampus interacts with temporo-occipital and medial parietal structures to enable successful memory formation and how these interactions are affected by aging. Here, we used Dynamic Causal Modeling (DCM) of fMRI data to elucidate the information flow between the hippocampus, the PPA and the precuneus during episodic memory formation for novel visual scene stimuli. In 117 young, healthy adults, we observed pronounced intrinsic activating input from the PPA to the hippocampus and inhibitory connectivity from the PPA to the precuneus during novelty processing, with both being further up-regulated during successful encoding. This pattern could be replicated in two cohorts of young and older adults (N = 58 young, 83 older; 64 young, 84 older). When testing for age effects on effective connectivity, we found that older adults exhibited attenuated negative PPA-precuneus connectivity, which correlated negatively with behavioral memory performance. Our results provide insight into the network dynamics underlying encoding-related activations and deactivations and further suggest that age-related differences in memory-related network activity manifest in altered temporo-parietal neocortical rather than hippocampal connectivity.

Is Rett syndrome associated with brain regional alterations in mitochondrial density and neuronal redox status?

Laura van Agen¹, Michael Müller¹

¹Universitätsmedizin Göttingen, Neuro- & Sensory Physiology, Humboldtallee , 37073 Göttingen, Germany

Rett syndrome (RTT) is a neurodevelopmental disorder mainly affecting females. It is characterized by an apparently normal development of 6-18 months, followed by a stagnation and eventually a decline in development. Typically, RTT is caused by mutations in the *MECP2* gene that is located on the X-chromosome and the symptoms include breathing abnormalities, motor deficits, loss of language, seizures, anxiety, autism spectrum disorder like features and metabolic alterations. The latter involves increased systemic oxidative damage, decreased brain ATP levels, and alterations in mitochondrial morphology and function. The X-chromosomal location leads to a challenging mosaicism of MeCP2 expression in the female brain. On the one hand this enables some cells to transcribe the intact gene, on the other it complicates diagnostic/mechanistic investigations and well-balanced therapeutic approaches in RTT, since an overexpression of MeCP2 leads to another severe disorder called *MECP2* duplication syndrome. Since mitochondrial alterations are considered an important contributor in RTT, therapies targeting mitochondria may be beneficial. However, to what extent mitochondria are affected in distinct parts of the brain and at the different disease stages, and how exactly this is linked to cellular redox alterations still needs to be discovered. To address potential RTT-related alterations in the density/activity of brain mitochondria, we performed citrate synthase activity assays in the different brain regions of adult mice (~7 weeks old). This revealed highest CSA activity in cortex, somewhat lower activities in hippocampus, midbrain and brainstem, and lowest CSA activities in cerebellum. This brain regional heterogeneity was similar in male and female mice, and did not differ significantly among wildtype and *MECP2*-mutant mice. As the CSA assay is interchangeably being used to rate mitochondrial mass and mitochondrial activity, we also ran confirmatory western blot analyses, focusing on the expression levels of the established mitochondrial marker TOM20 in female WT mice. These protein expression experiments revealed the very same order of mitochondrial mass, as observed in the CSA assay. Accordingly, RTT-related changes in mitochondrial mass were not obvious in the analysed RTT-mouse model. To be able to rate the impact of mitochondria on cellular redox-balance, we also established the quantitative imaging of cellular (cytosolic) redox-balance in living brain tissue slices. In a sophisticated stepwise protocol of live-cell imaging, tissue fixation and immunohistochemistry we are now able to correlate cellular redox-balance in various forebrain neurons with the presence/absence of MeCP2 on the single-cell level. This will reveal the impact on MeCP2 function on cellular redox conditions, potential interactions of neighbouring cells on the tissue level, as well as the extent of redox impairment along disease progression. Likewise, a powerful tool will be available to rate the outcome of mitochondria- and redox-targeted therapeutic concepts in RTT.

Supported by the DFG (Projektnummer 456368804)

Developmental changes in the electrophysiological properties of pyramidal neurons in the auditory cortex of the *Cntnap2* KO rat model of Autism Spectrum Disorder.

Rajkamalpreet S. Mann¹, Brian L. Allman¹, Susanne Schmid¹

¹University of Western Ontario, Anatomy and Cell Biology, 14 Masonvill Crescent, N5X3T2 London, Canada

The contactin-associated protein-like 2 (*Cntnap2*) gene, which codes for the cell-adhesion protein CASPR2, is highly important for brain development, especially in sensory structures and areas central for language development. Disruptions in *Cntnap2* result in neurodevelopment disorder displaying the core symptoms of autism spectrum disorder (ASD) and moderate to severe language impairments in humans. Importantly, the *Cntnap2* gene is not exclusive to humans and is expressed throughout the sensory and cortico-striato-thalamic circuits in other animals. Knocking out this gene in rodents results in ASD-like symptoms that include auditory processing deficits. A homozygous *Cntnap2* gene functional knockout in mice and rats is known to disrupt basic brain functions relying on auditory processing, such as the acoustic startle response and sensorimotor gating. Though it is well established that *Cntnap2* is essential for auditory processing, its mechanisms of action at the cellular level and how it affects neural circuits required for auditory processing have not yet been characterized. This study used in vitro electrophysiology to examine developmental alterations in auditory cortex pyramidal neurons of *Cntnap2*^{-/-} rats, hypothesizing that CNTNAP2 is essential for maintaining intrinsic neuronal properties and synaptic wiring in the developing auditory cortex.

Whole-cell patch-clamp recordings were conducted in wildtype and *Cntnap2*^{-/-} littermates at 3 postnatal age ranges (P8-12, P18-21, and P70-90 days). Consistent and expected changes across age were seen in all measures of intrinsic membrane properties and spontaneous synaptic input. Furthermore, *Cntnap2*^{-/-} rats showed alterations in intrinsic cell properties during the juvenile stage (P18-21) that included smaller action potential half widths, smaller rheobase, and higher action-potential firing frequencies than in wild-type animals, while there were no differences in these measures in the P8-12 and P70-90 groups. *Cntnap2*^{-/-} rats also showed higher spontaneous (sEPSC) and mini excitatory post-synaptic currents (mEPSC) frequencies, with lower sEPSC amplitudes at P70-90. These results indicate that intrinsic cell properties are altered in *Cntnap2*^{-/-} during the juvenile age, leading to a hyperexcitable phenotype during this stage of synaptic remodeling and refinement. While intrinsic properties eventually normalize by reaching adulthood, changes in synaptic input seem to manifest in the adult age and are presumably responsible for the hyperreactive behavioral phenotype. These experiments will provide novel insights into how *Cntnap2* impacts auditory processing networks at a cellular level, and shed light on the neural mechanisms underlying altered auditory processing seen in *Cntnap2*^{-/-} rats.

Multi-modal epigenetic changes and altered NEUROD1 chromatin binding in the mouse hippocampus underlie FOXG1 syndrome

Ipek Akol^{1,2}, Annalisa Izzo¹, Thomas Manke³, Tanja Vogel^{1,4}

¹Institute for Anatomy and Cell Biology, Dept. Molecular Embryology, Medical Faculty, University of Freiburg, 79104 Freiburg, Germany

²Faculty of Biology, University of Freiburg, 79104 Freiburg, Germany

³Max Planck Institute of Immunobiology and Epigenetics, 79108 Freiburg, Germany

⁴Center for Basics in NeuroModulation (NeuroModul Basics), Medical Faculty, Albert-Ludwigs-University Freiburg, 79104 Freiburg, Germany

Development of the central nervous system (CNS) depends on accurate spatiotemporal control of signalling pathways and transcription programs. The transcription factor Forkhead Box G1 (FOXG1) is one of the master regulators that plays fundamental roles in forebrain development, from the timing of neurogenesis to the patterning of the cerebral cortex. Mutations in the *FOXG1* gene cause a rare neurodevelopmental disorder called FOXG1 syndrome. FOXG1 syndrome patients manifest a spectrum of phenotypes ranging from severe cognitive dysfunction and microcephaly to social withdrawal and communication deficits with varying severities. Although there has been steady progress towards understanding the role of FOXG1 in neurodevelopment and linked disorders, the multifaceted functions of FOXG1 and the changes at the molecular level remain largely unexplored.

Using multi-omics data encompassing RNA-, ChIP-, and ATAC-seq datasets, we extensively explored the influence of FOXG1 on neuronal maturation at the chromatin level in the adult mouse hippocampus. Our study revealed that FOXG1 regulates transcription in a varied and context-dependent manner at the chromatin level. FOXG1 both repressed and activated transcription, binding mainly to enhancer regions and affecting the epigenetic landscape bidirectionally. The alterations in the chromatin affected functions such as synaptogenesis and axonogenesis, signifying the role of FOXG1 in the regulation of genes required for proper neuronal function. Notably, FOXG1 interacted with histone deacetylases (HDACs) and inhibition of HDACs partially rescued transcriptional alterations observed upon FOXG1 reduction. We have also identified NEUROD1 as a novel interaction partner of FOXG1, which coordinated with FOXG1 to control neuronal differentiation.

Together, our integrative approach uncovered that FOXG1 acts through different epigenetic mechanisms and in concert with other TFs, one of which is NEUROD1, emphasising the multimodality of FOXG1 at the chromatin level.

Multiple facets of heterozygous FOXP1 loss on neural development and FOXP1 syndrome outcome in different patient-specific backgrounds

Fabian Gather¹, Ipek Akol^{1,2}, Analia Rojas Caballero¹, Christos Galanis³, Andreas Vlachos^{3,4,5}, Tanja Vogel^{1,6}

¹Institute of Anatomy and Cell Biology, University of Freiburg, Department of Molecular Embryology, Developmental Neuroepigenetics Lab, Albertstr. 23, 79104 Freiburg im Breisgau, Germany

²Faculty of Biology, Albert-Ludwigs-University Freiburg, 79104 Freiburg, Germany

³Center for Basics in NeuroModulation (NeuroModul Basics), Medical Faculty, Albert-Ludwigs-University Freiburg, 79104 Freiburg, Germany

⁴Institute for Anatomy and Cell Biology, Department of Neuroanatomy, Faculty of Medicine, Albert-Ludwigs-University Freiburg, 79104 Freiburg, Germany

⁵Center BrainLinks-BrainTools, University of Freiburg, Freiburg, Germany

⁶Freiburg Institute for Advanced Studies (FRIAS), Albert-Ludwigs-University Freiburg, 79104 Freiburg, Germany

Development of the central nervous system (CNS) depends on accurate spatiotemporal control of signaling pathways and transcriptional programs. Forkhead Box G1 (FOXP1) is one of the master regulators that plays fundamental roles in forebrain development. Mutations in the FOXP1 gene cause a rare neurodevelopmental disorder called FOXP1 syndrome. Patients presenting with FOXP1 syndrome manifest a spectrum of phenotypes, ranging from severe cognitive dysfunction and microcephaly to social withdrawal and communication deficits. To develop and improve therapeutic interventions, research to unravel the multi-faceted functions of FOXP1 in neurodevelopment and pathogenesis of FOXP1 syndrome is highly needed.

Previous experiments showed several potential interaction partners and downstream targets of FOXP1 action, like other transcription factors, non-coding RNA and enzymes for example responsible for neurite outgrowth. Since these experiments were done in mouse models, the transferability of the results to individual patients remains to be shown. Especially the genetic background as well as the different variants from heterozygous deletion of FOXP1 to frameshift and truncated FOXP1 variants complicates the transferability and individualize the final manifestation of FOXP1 syndrome symptoms. To investigate the individual impact we analyzed patient derived cells that we generated by differentiation of patient derived human induced pluripotent stem cells (hiPSCs) and could observe differences in gene expression not only between patient and healthy donor but also between different patient derived cells with either loss of one FOXP1 allele or the presence of a truncated FOXP1 variant. In addition to differently expressed genes in general, analyses of RNAseq data of patient hiPSC derived neural stem cells (NSCs) also revealed different isoform usage. To complete the picture of differences between the patients and to take into account the environmental influences of a developing brain, also brain organoids derived from the same patient hiPSCs were analyzed.

All in all, we could show that FOXP1 plays an important role in brain development by transcriptional regulation of genes connected to dendritic complexity. Therapies have to be adapted to the individual outcome of FOXP1 syndrome and therefore to the genetic background and individual FOXP1 mutation, as we could show by the differences in neural development and gene expression after differentiation of patient derived hiPSCs into neural lineages and brain organoids.

Pathophysiological and structural consequences of novel mutations in the asparagine synthetase gene (ASNS) associated with microcephaly

Dorit John¹, Ulrike Winkler¹, Tabea Junge¹, Maximilian Liebmann¹, Anja Reinert¹,
Susanne Köhler¹, Johannes Hirrlinger^{1,2}

¹Carl-Ludwig-Institute for Physiology, Faculty of Medicine, University of Leipzig, Liebigstr. 27, D-04103 Leipzig, Germany

²Department of Neurogenetics, Max-Planck-Institute for Multidisciplinary Sciences, Hermann-Rein-Str. 3, D-37075 Göttingen, Germany

Microcephaly is a devastating condition defined by a small head and small brain compared to the age- and sex-matched population. Mutations in genes involved the synthesis of several non-essential amino acids have been described which cause a severe neurological and/or neurodevelopmental phenotype. This includes the gene encoding the enzyme asparagine synthetase (ASNS), which catalyzes the ATP dependent synthesis of asparagine from aspartate using glutamine or ammonia as nitrogen donor. In a family with two affected girls, we identified two novel compound heterozygous variants in *ASNS* (c.1165G>C, p.E389Q and c.601delA, p.M201Wfs*28). Based on the observation that in patients the central nervous system is strongly affected, while other organs show almost no impairment, we hypothesize a novel, brain-specific function of ASNS. To study the pathophysiological mechanisms linking mutations in the *ASNS* gene to the development of microcephaly, we established a conditional, neuron-specific knockout mouse model. As expected from the neuronal expression of ASNS, these neuron-specific knockout mice almost completely lacked expression of ASNS. Applying different techniques, we investigated the impact of this conditional *Asns* knockout on the structural, molecular, cellular and metabolic level. Importantly, the knockout mice develop a microcephaly as observed in human patients. Our results point towards a complex phenotype including changes of gene expression, regulation of signaling pathways, adaptation of metabolism, as well as subtle microgliosis. These aspects are currently under further investigation which will help to elucidate the pathophysiological consequences of mutations in ASNS.

TOGARAM1 mutation in spina bifida highlights alternative mechanisms in neural tube closure defects

YANYAN WANG¹, Nadine Krämer^{1,2,3}, Olaf Ninnemann¹, Joanna Schneider^{3,4,5}, Li Na⁶, Hao Hu⁶, Shyamala Mani^{1,2,3}, Angela Kaindl^{1,2,3}

¹Charité – Universitätsmedizin Berlin, Institute of Cell- and Neurobiology, Charitéplatz 1, 10117 Berlin, Germany

²Charité – Universitätsmedizin Berlin, Department of Pediatric Neurology, Augustenburger Platz 1, 13353 Berlin, Germany

³Charité – Universitätsmedizin Berlin, Center for Chronically Sick Children (Sozialpädiatrisches Zentrum, SPZ), Augustenburger Platz 1, 13353 Berlin, Germany

⁴Department of Pediatric Neurology, Charité - Universitätsmedizin Berlin, Berlin, Germany.

⁵Berlin Institute of Health, Berlin, Germany

⁶Laboratory of Medical Systems Biology, Guangzhou Women and Children's Medical Center, Guangzhou Medical University, Guangzhou, China

The developmental event of neural tube closure occurs in the mouse between embryonic day 8.5 -10 and in humans between 18 -28 days post fertilization. Incomplete neural tube closure in the spinal cord leads to spina bifida, a common birth defect occurring in 0.5 per 1000 pregnancies in Europe, including live births, pregnancy losses, and terminations. The causes of spina bifida are multifactorial with contribution of genetic and non-genetic factors. In most patients, the underlying pathomechanism remains unresolved. Mouse models have been important in elucidating the cell biological processes and signalling pathways underlying neural tube closure. One important signalling pathway in neural tube patterning involves the sonic hedgehog (SHH), one of three mammalian homologues of the *Drosophila* hedgehog gene. Signalling is initiated by the binding of SHH to the transmembrane receptor patched1 that relieves its inhibition on the associated membrane protein smoothened. This allows the Gli family of proteins to be processed into transcriptional activators of SHH target genes. Normal neurulation is thought to involve the inhibition of this signalling pathway in the dorsolateral neural plate and in line with this, most neural tube closure defects are due to mutations in proteins that inhibit SHH signalling. In contrast, mutations in genes that activate SHH signalling, including SHH itself and smoothened do not produce neural tube defects.

TOGARAM1, also known as FAM179B or crescerin-1, belongs to the crescerin family defined by an array of microtubule binding TOG domains conserved across ciliated/flagellated organisms and mutations in this gene has been linked previously to ciliopathy. We show that mutation of this gene leads to neural tube defects in both human and mouse. We further show that loss of function of *Togaram1* results in decreased number of cilia and reduced SHH signalling in mouse neural stem cells. Our results suggest that while reduction in SHH signalling per se may not result in neural tube closure defects when combined with cilia defects neural tube closure is indeed affected. These results highlight the need to understand the role of cilia in neural tube closure and point to the need for genetic screening of ciliopathy genes as a risk factor for human neural tube closure defects.

Cell type - specific functions of the DNA methyltransferase 1 in cortical interneuron development

Julia Reichard^{1,2}, Jenice Reimara Nicola Linde^{1,2}, Can Bora Yildiz^{1,2}, Georg Pitschelatow^{1,2}, Geraldine Zimmer-Bensch^{1,2}

¹RWTH Aachen University, Institute for Biology 2, Department of Neuroepigenetics, Worringerweg 3, 52074 Aachen, Germany

²Research Training Group 2416 "Multisenses-Multiscales", Institute for Biology 2, Worringerweg 3, 52074 Aachen, Germany

Proper brain function critically relies on tight orchestration of neuronal processes within the cerebral neocortex. For this purpose, a delicate balance between excitation and inhibition depending on defined numbers of excitatory projection neurons and inhibitory gamma-aminobutyric (GABA)-positive interneurons is indispensable. Although contributing to only 20% of the entire neuronal population in the cortex, interneurons are key for cortical processing. Defects during interneuron development are known to be associated with severe neuropsychiatric diseases such as schizophrenia, epilepsy or autism spectrum disorder. In this context, epigenetic mechanisms emerged as crucial regulators of neuronal development including cortical interneurons. In previous studies we found an essential implication of the DNA methyltransferase 1 (DNMT1) in promoting the long-range migration of inhibitory cortical interneurons generated in the embryonic pre-optic area (POA). In these cells, DNMT1 maintains their migratory morphology and survival via transcriptional regulation through crosstalk with histone modifications.

Poster Topic

T11: Alzheimer's, Parkinson's and other Neurodegenerative Diseases

- [T11-1A](#) A multimodal perspective on the dopamine hypothesis in schizophrenia spectrum disorders – preliminary data
Sophie Pauline Fromm, Lara Wieland, Florian Schlagenhaut, Jakob Kaminski
- [T11-2A](#) Alzheimer's disease might be also a failure of inhibitory synapses at early and late stages of pathogenesis that can be rescued by Artemisinin.
Jochen Kuhse, Stefan Kins, Femke Groeneweg, Karin Gorgas, Joachim Kirsch, Eva Kiss
- [T11-3A](#) Analysis of the influence of the glutamate signaling pathway on repair of radiation-induced DNA damage in tumor-initiating neuronal cancer cells.
Dario Macarron Palacios, Henrik Lutz, Bodo Laube
- [T11-4A](#) Antibodies to the low-density lipoprotein-receptor-associated-protein Lrpap-1 are found not in cerebrospinal fluid or blood serum of Alzheimer's disease patients, but in serum of healthy controls
Bernhard Reuss, Niels Hansen, Jens Wiltfang
- [T11-5A](#) APP α rescues kinase dysregulations in Tau transgenic mice
Danny Baltissen, Charlotte Bold, Lena Rehra, Justus Fricke, Jennifer Just, Christian Buchholz, Martin Korte, Ulrike Müller
- [T11-6A](#) Bimodal potentiation of cholinergic neurotransmission in rats transgenic for familial Alzheimer's mutations
Johanna Habermeyer, Fabio Canneva, Stephan von Hörsten
- [T11-7A](#) Cerebellar network in a model of paroxysmal dystonia
Fabiana Santana Kragelund, Denise Franz, Marco Heerdegen, Anika Lüttig, Stefanie Perl, Angelika Richter, Rüdiger Köhling
- [T11-8A](#) Changes in inhibitory glycine receptors function in the nucleus accumbens in an Alzheimer's Disease animal model
Luis Aguayo, Scarlet Gallegos, Anibal Araya, Alejandra Guzmán, Macarena Konar-Nie, Eduardo Fernandez-Perez, Lorena Armijo-Weingart
- [T11-9A](#) Developmental stage-specific analysis of molecular disease mechanisms in genetic epileptic

encephalopathies linked to HCN1 channels

Jacquelin Kasemir, Andrea Merseburg, Bina Santoro, Dirk Isbrandt

- [T11-10A](#) Distribution of the effect of botulinum neurotoxin-A in the rat brain after its experimental unilateral injection into the striatum for experimental Parkinson's disease treatment
Alexander Hawlitschka, Oliver Schmitt, Andreas Wee, Friederike Schümann
- [T11-11A](#) Effects of the Medial Septum electrical stimulation on okadaic acid induced spatial long-term memory impairment: a behavioral and histological evaluation
Mariam Chighladze, Maia Burjanadze, Manana Dashniani, Nino Chkhikvishvili, Lali Kruashvili
- [T11-1B](#) Elucidating early molecular events of human cortical ALS pathophysiology at single cell resolution
Zeynep Irem Gunes, Klara Magdalena Eglseer, Charlene-Annett Hurler, Sarah Jaekel, Eduardo Beltran, Thomas Arzberger, Sabine Liebscher
- [T11-2B](#) Excitability changes in hippocampal neurons in the rodent models of Alzheimer's disease and a way to prevent it
Liudmila Sosulina, Hiroshi Kaneko, Anja M. Oelschlegel, Katarzyna M. Grochowska, Guilherme M. Gomes, Carsten Reissner, Manuel Mittag, Martin Fuhrmann, Anna Karpova, Michael R. Kreutz, Stefan Remy
- [T11-3B](#) Expression profiling and functional characterization of candidate MicroRNA associated with frontotemporal dementia
Lalit Kaurani, Jiayin Zhou, Ranjit Pradhan, Aditi Methi, Susanne Burkhardt, Raquel Pinto, MD Rezaul Islam, Sophie Schröder, Peter Heutink, Farahnaz Sananbenesi, Andre Fischer
- [T11-4B](#) Extracellular matrix changes in subcellular brain fractions and biofluid of Alzheimer's disease patients
Lukas Höhn, Wilhelm Hußler, Anni Richter, Karl-Heinz Smalla, Anna-Maria Birkl-Töglhofer, Christoph Birkl, Stefan Vielhaber, Stefan L. Leber, Eckart D. Gundelfinger, Stefanie Schreiber, Johannes Haybäck, Constanze I. Seidenbecher
- [T11-5B](#) Hippocampal low-frequency stimulation suppresses epileptic activity without affecting learning and memory in a mouse model of epilepsy
Enya Paschen, Piret Kleis, Jessica Link, Diego M Vieira, Katharina Heining, Ute Häussler, Carola A Haas
- [T11-6B](#) Identification of optimal stimulation targets and parameters to suppress seizures in a mouse model of mesial temporal lobe epilepsy
Piret Kleis, Enya Paschen, Jessica Link, Diego M. Vieira, Katharina Heining, Ute Häussler, Carola A. Haas
- [T11-7B](#) Impact of FTY720 on memory performance and hippocampal spines of aged APP/PS1 mice
Lukas Schönwolf, Thomas Endres, Volkmar Leßmann
- [T11-8B](#) Impact of TDP-43 pathology and ER stress on cortical neuronal health *in vivo*

- [T11-9B](#) Investigation of mitochondrial protein-import stress induced neuronal degeneration
Johannes Ebding, Marlene Barth, Maximilian Goy, Adrian Gackstatter, Martin Simon, Johannes Herrmann, Jan Pielage
- [T11-10B](#) Loss of interneurons in the subiculum in a mouse model for mesial temporal lobe epilepsy
Nicole Barheier, Julia Franz, Henrike Wilms, Susanne Tulke, Carola A. Haas, Ute Häussler
- [T11-11B](#) Metabolic and cellular factors determining the therapeutic effect of dimethyl fumarate
Joanna Maria Kosinska, Julian Assmann, Julica Folberth, Markus Schwaninger
- [T11-12B](#) Phosphorylation-state dependent intraneuronal sorting of A β differentially impairs autophagy-endo-lysosomal system and ubiquitin proteasomal machinery
Akshay Kapadia, Sandra Theil, Sabine Opitz, Nàdia Villacampa, Susanne Schoch-McGovern, Michael. T. Heneka, Sathish Kumar, Jochen Walter
- [T11-1C](#) Modulation of periaqueductal grey defense circuitry by locus coeruleus in context of Parkinson's disease
Alexia Lantheaume, Konstantin Kobel, Michael Schellenberger, Dennis Segebarth, Philip Tovote
- [T11-2C](#) Pharmacological Modulation of Serotonin Receptor 7 as a Potential Treatment for Tau-associated Neurodegenerative Diseases
Alina Brùge, Kathrin Jahreis, Sungsu Lim, Yun Kyung Kim, Marcello Leopoldo, Evgeni Ponimaskin, Josephine Labus Labus
- [T11-3C](#) Probing astroglial dysfunction in motor cortex of behaving ALS transgenic mice
XiaoQian Ye, Zeynep Gunes, Sabine Liebscher
- T11-4C Retracted
- [T11-5C](#) Role of Bassoon in the regulation of presynaptic proteostasis
Carolina Montenegro Venegas, Anil Annamneedi, Armand Blondiaux, Judit Ozvár, Yi Lien, Thorsten Trimbuch, Christian Rosenmund, Craig Craig Curtis Garner, Eckart D Gundelfinger
- [T11-6C](#) Serotonin receptors contribute to TDP-43 aggregation in neurodegenerative diseases
Josephine Labus, Anna-Lena Vollbrecht, Julia Kleinert, Tilman Tiss, Sungsu Lim, Yun Kyung Kim, Thomas Gschwendtberger, Susanne Petri, Evgeni Ponimaskin
- [T11-7C](#) Synaptic transmission defects at an early stage in juvenile Batten disease mouse model
Masood Ahmad Wani, Benedikt Grünwald, Jakob von Engelhardt
- [T11-8C](#) The pallidal inhibitory tone on ventrolateral thalamic neurons in dystonic dt^{SZ} mutant hamster after long-term deep brain stimulation
Denise Franz, Marco Heerddegen, Fabiana Santana Kragelund, Anika Lüttig, Angelika Richter, Rüdiger Köhling

- [T11-9C](#) The use of human gastrointestinal organoids to study interactions with the nerve system and the induction of neuroinflammation by pathogens including *Helicobacter pylori*
Marzieh Ehsani, Zeyang Sun, Huo Peng, David Holthaus, Saskia F. Erttmann, Thomas F. Meyer
- [T11-10C](#) Time lapse imaging of single granule cells in the mouse dentate gyrus after entorhinal denervation in vitro – identification of different response types to denervation
Davide Greco, Alexander Drakew, Thomas Deller
- [T11-11C](#) Two-photon imaging identifies blood-brain barrier alterations in a murine Alzheimer's disease model
Amira S. Hanafy, Isabelle Paulußen, Alf Lamprecht, Dirk Dietrich

A multimodal perspective on the dopamine hypothesis in schizophrenia spectrum disorders – preliminary data

Sophie Pauline Fromm^{1,2,3,4}, Lara Wieland^{1,2,3}, Florian Schlagenhaut^{1,2,3}, Jakob Kaminski¹

¹Department of Psychiatry and Neuroscience | CCM, Charité-Universitätsmedizin Berlin, corporate member of Freie Universität Berlin, Humboldt-Universität zu Berlin, and Berlin Institute of Health CCM, Berlin, German

²Charité – Universitätsmedizin Berlin, Einstein Center for Neurosciences Berlin, Berlin, Germany

³Bernstein Center for Computational Neuroscience, Berlin, Germany

⁴Department of Psychology, Humboldt-Universität zu Berlin, Germany

Objective: MRI sequences that are optimized for the magnetic properties of iron could be a readily available proxy for dopamine dysfunction in schizophrenia. Based on prior research, we expect differences in iron-sensitive signal intensity ($R2^*$ contrast) in patients compared to healthy controls, suggesting altered dopamine turnover. We here explore the relationship of signal intensity from iron-sensitive MRI signals with psychotic symptoms and with dopamine synthesis capacity.

Method: In 28 patients with schizophrenia (9f, 19m; $37y \pm 9$) and 25 healthy control participants (12f, 13m; $31y \pm 10$), we collected quantitative MRI data using multi-parameter mapping sequences including longitudinal relaxation rate ($R1 = 1/T1$), effective transverse relaxation rate ($R2^* = 1/T2^*$), magnetization transfer (MT) and proton density sequences (PD, Weiskopf, et al., 2015). Regions of interest (substantia nigra (SN) and striatum) were defined using anatomical masks. We predicted $R2^*$ signal intensity in the SN by group status, while controlling for age. In a subgroup of 16 healthy participants, we collected ^{18}F -dopa PET scans. Psychiatric assessment was conducted using the Positive and Negative Syndrome Scale interview (Kay et al., 1987) and neuropsychological assessment by means of the Brief Assessment for Cognition in Schizophrenia (Keefe et al., 2006). We correlated the striatal PET-signal and psychiatric symptomatology with the $R2^*$ signal intensity. We here present preliminary data as data collection is still ongoing.

Results: $R2^*$ signal intensity in the SN was lower in patients than healthy controls ($\beta=3.1, t(50)=3.29, p=.002$), while controlling for age. We observed no relationship with positive symptoms ($\beta=-.018, t(40)=-.26, p=.793$) and a trend-level relationship with negative symptoms ($\beta=-.16, t(40)=-1.75, p=.088$). ^{18}F Dopa-PET in the whole striatum was not related to striatal $R2^*$ signal intensity ($\beta=302.06, t(12)=1.001, p=.337$). However, we observed a trend-wise positive relationship in the right associative subregion ($r=.47, p=.078$). Healthy participants showed higher SN signal intensity of $R1$ ($\beta=.077, t(50) = 5.56, .001$), of MT ($\beta=.22, t(50) = 4.3, p=.001$) and of PD ($\beta=9.44, t(40)=23.69, p=.001$) in the SN as compared to patients.

Conclusion: One major limitation of the presented findings is that we here analyzed raw data and did not yet control for nuisance parameters with a suitable control region. Our preliminary results show that quantitative susceptibility mapping of the substantia nigra may provide a useful tool to quantify dopamine dysfunction in schizophrenia. We observed lower absolute signal intensity in patients than in controls. Our findings suggest a positive relationship of $R2^*$ with dopamine synthesis capacity in the striatum and negative symptoms. Future analysis with larger sample size may provide more insight into potential relationships of quantitative

iron-sensitive MRI sequences with proxies of dopamine dysfunction and symptomatology in schizophrenia.

Alzheimer's disease might be also a failure of inhibitory synapses at early and late stages of pathogenesis that can be rescued by Artemisininins.

Jochen Kuhse¹, Stefan Kins², Femke Groeneweg³, Karin Gorgas³, Joachim Kirsch³, Eva Kiss⁴

¹Department of Cellular and Molecular Biology, University of Medicine Pharmacy, Science and Technology, Targu Mures, Targu Mures, Romania

²Department of Human Biology and Human Genetics, University of Kaiserslautern, Germany

³Institute of Anatomy and Cell Biology, University of Heidelberg, Heidelberg, Germany

⁴Department of Cellular and Molecular Biology, University of Medicine Pharmacy, Science and Technology, Targu Mures, Targu Mures, Romania

We used the Alzheimer's disease mouse model APP-PS1 to study the expression of proteins related to inhibitory neurotransmission in the hippocampus in conditions of increased amyloidosis. At 12 months of age the $\gamma 2$ subunit of the GABAA receptor was significantly reduced as well as the scaffold protein gephyrin, which anchors GABAA receptors and glycine receptors (GlyRs) at postsynaptic membrane specializations. In addition, specifically the GlyRA3 subunit showed also significantly lower protein expression level in the hippocampus of APP-PS1 mice in comparison to wild type mice. The treatment of the APP-PS1 mice with 10 mg/kg or 100 mg/kg Artemisininins for three month's rescued the expression of these three key-proteins to about wild type levels. Importantly, at the same time the level of A β , APP C-terminal fragments (CTFs) and the plaque load in hippocampus and cortex were reduced by this treatment.

The identification of alterations in brain structure and function in early, pre-symptomatic stages is thought to be of crucial importance for protective interventions. Thus, we analyzed also APP-PS1 mice at 3 months of age, when amyloid plaques start to develop and found that not only the level of gephyrin but also gephyrin and tau phosphorylation are increased already at this early stage of disease. Parallel, elevated CDK5 and p35 protein levels, both involved in tau and gephyrin phosphorylation, were detected. Moreover, we could show that the increased phosphorylation of gephyrin at Ser270, known to be crucially involved in gephyrin- and $\gamma 2$ - protein density at postsynaptic sites, correlated with increased $\gamma 2$ -expression in the hippocampus of APP-PS1 mice and altered features of sharp wave-ripple complexes (SPW-R) in the CA1/CA3 regions. In conclusion, our data strongly support that alterations in the inhibitory neurotransmission, which might be caused by A β , might induce disturbances in brain functions in early and late stages of AD-development that can be modulated by Artemisininins.

Analysis of the influence of the glutamate signaling pathway on repair of radiation-induced DNA damage in tumor-initiating neuronal cancer cells.

Dario Macarron Palacios¹, Henrik Lutz¹, Bodo Laube¹

¹Technical University of Darmstadt, Neurophysiology and neurosensory systems, Schnittspahnstraße 3, 64287 Darmstadt, Germany

Glioblastoma multiforme (GBM) is an incurable cancer of the central nervous system and the most common primary brain tumor in adults. Current therapies are challenged by GBM's invasive growth and chemoradioresistance. Resistance of GBM to ionizing radiation (IR) is promoted by an enhanced DNA damage response of double-strand breaks (DSBs). GBM tumors are highly heterogeneous. Their heterogeneity is due to different characteristics of subpopulations within the tumor with variable expression patterns and resistance. These cells with a highly tumorigenic nature have been termed tumor-initiating cells (TICs). TICs can generate cancer cells with different characteristics and give rise to tumors that faithfully reflect the phenotype of the original tumor. The ability of TICs to proliferate and generate GBM cancer cells with different phenotypes led to the name "glioma stem cells" (GSCs), which are thought to primarily initiate GBM.

Glutamate activates Ca²⁺-permeable N-methyl-D-aspartate receptors (NMDARs), which are important for excitatory synaptic transmission and expression of early response genes (ERGs) in neurons. Remarkably, the expression of NMDAR-induced ERGs depends on topoisomerase2b (Top2β)-activity-generated DSBs at the transcription start site of these genes. It has been shown that activation of NMDARs can contribute to tumor malignancy by promoting growth, survival, migration, and DSB damage repair. A previous study by our research group demonstrated functional NMDAR signaling in LN229 cells. Some NMDAR-induced neuronal ERGs encode proto-oncogenes such as *cFos*, suggesting that GBM cells misuse NMDAR signaling pathways to promote proto-oncogene expression. Immunofluorescence staining of the DSB marker 53BP1 showed that in a CD133⁺ subpopulation of GBM cells, DSBs are formed after activation of NMDARs on the one hand but also the repair of IR-induced DSBs is enhanced. In a clonogenic survival assay, knockdown of Top2β and inhibition of NMDARs reduced the resistance of LN229 cells to X-rays. The results presented demonstrate a functional Top2β-dependent NMDAR signaling pathway in a subpopulation of GBM cells.

TICs represent a subpopulation of cells that play a key role in novel therapeutic strategies. The goal of the current study is to identify in detail this subpopulation of LN229 cells that utilize a functional Top2β-dependent NMDAR signaling pathway. Therefore, stem cell markers such as CD133 or CD44 will be used for immunofluorescence staining and further characterization of this subpopulation. Identification of NMDAR signaling pathways used by these TICs in GBM may help to develop NMDAR-targeted cancer therapies that strongly affect GBM cells but do not disrupt glutamatergic synaptic transmission in the brain.

Antibodies to the low-density lipoprotein-receptor-associated-protein Lrpap-1 are found not in cerebrospinal fluid or blood serum of Alzheimer's disease patients, but in serum of healthy controls

Bernhard Reuss¹, Niels Hansen², Jens Wiltfang²

¹University Medical Center, Institute for Neuroanatomy, Kreuzberggring 36, 37075 Göttingen, Germany

²University Medical Center, Clinic of Psychiatry and Psychotherapy, Von-Siebold-Str. 5, 37075 Göttingen, Germany

In the brains of Alzheimer's disease (AD) patients, β -amyloid ($A\beta$) accumulates in senile plaques, leading to neurodegeneration and cognitive decline. This depends on impaired $A\beta$ -clearance over the blood brain barrier by the LDL-receptor-related-protein-1, and its regulator, the low-density-lipoprotein-receptor-associated-protein-1 (Lrpap1), expression of which is reduced in brain samples of AD-patients. In this context a previous *in-vitro*-finding, that antibodies directed to the Gram positive bacterium *Listeria monocytogenes* can interact with Lrpap-1, and by this increase β -amyloid levels in human neuroblastoma cell lines, seemed to us to be of importance. To further clarify the *in-vivo*-relevance of such a mechanism, we analysed here the presence of antibodies binding to Lrpap1 in cerebrospinal fluid and blood serum samples from either AD-patients or from healthy controls using a commercial multiprotein array and other proteomic methods. In contrast to our expectations antibodies interacting with Lrpap-1 could not be detected in either AD-patients' liquor or serum samples, however were highly abundant in blood serum of healthy controls. Therefore, in conclusion, the results of the present study are contradictory to a direct role of autoantibodies to Lrpap1 in AD-pathogenesis. This suggests also that the previously reported lower levels of Lrpap1 in AD-patients' brains are probably not caused by an antibody dependent mechanism.

APP α rescues kinase dysregulations in Tau transgenic mice

Danny Baltissen¹, Charlotte Bold¹, Lena Rehra¹, Justus Fricke¹, Jennifer Just², Christian Buchholz³, Martin Korte², Ulrike Müller¹

¹University of Heidelberg, Functional Genomics, Im Neuenheimer Feld 364, 69120 Heidelberg, Germany

²TU Braunschweig, Division of Cellular Neurobiology, Spielmannstraße 7, 38106 Braunschweig, Germany

³Paul-Ehrlich-Institut, Molekulare Biotechnologie und Gentherapie, Paul-Ehrlich-Straße 51-59, 63225 Langen, Germany

The Tau protein can be phosphorylated by numerous kinases. In Alzheimer's disease (AD) hyperphosphorylated Tau species accumulate as neurofibrillary tangles that constitute a major hallmark of AD. AD is further characterized by extracellular A β plaques, derived from the β -amyloid precursor protein APP. Whereas A β is produced by amyloidogenic APP processing, APP processing along the competing non-amyloidogenic pathway results in the secretion of neurotrophic and synaptotrophic APP α . Recently, we demonstrated that APP α has therapeutic effects in transgenic AD model mice and rescues A β -dependent impairments.

Here, we examined the potential of APP α to regulate two major tau kinases, GSK3 β and CDK5 in THY-Tau22 mice, a widely used mouse model of tauopathy. Immunohistochemistry revealed a dramatic increase in pathologically phosphorylated (AT8, AT100) or misfolded Tau species (MC1) in the hippocampus of THY-Tau22 mice between 3-12 months of age. Using a highly sensitive radioactive kinase assay with recombinant human tau, we demonstrate an increase in GSK3 β and CDK5 activity in the hippocampus of Thy-Tau22 mice. Interestingly, AAV-mediated intracranial expression of APP α in THY-Tau22 mice efficiently restored normal GSK3 β and CDK5 activity. Western blot analysis revealed upregulation of the CDK5 regulatory proteins p35 and p25, indicating CDK5 hyperactivation in THY-Tau22 mice. Strikingly, AAV-APP α rescued p25 upregulation to wild-type levels even at stages of advanced Tau pathology. Sarkosyl fractionation used to study the abundance of soluble and insoluble phospho-Tau species revealed increased soluble AT8-Tau and decreased insoluble AT100-Tau species upon AAV-APP α injection. Moreover, AAV-APP α reduced misfolded (MC1) Tau species, particularly in somatodendritic compartments of CA1 pyramidal neurons. Finally, we show that AAV-APP α normalized PSD95 expression and deficits in spine density of THY-Tau22 mice.

Together our findings suggest that APP α holds therapeutic potential to mitigate Tau-induced pathology.

Bimodal potentiation of cholinergic neurotransmission in rats transgenic for familial Alzheimer's mutations

Johanna Habermeyer¹, Fabio Canneva¹, Stephan von Hörsten¹

¹Universitätsklinikum Erlangen, Experimental Therapy and Preclinical Experimental Animal Center, Palmsanlage 5, 91054 Erlangen, Germany

Since current treatment strategies for Alzheimer's Disease (AD) show not only limited efficacy but also distinct side effects, new and innovative approaches are needed to provide successful therapy within a worldwide aging population. Previous studies propose the combination of clinically-used acetylcholine esterase inhibitors (AChEIs; e.g. galantamine) with other modulators of the cholinergic neurotransmission, such as positive allosteric modulators (PAMs) of nicotinic acetylcholine receptors (nAChRs) in order to further support cholinergic signaling. Cotinine, the main metabolite of nicotine, acts as a PAM at alpha7nAChRs and has promising effects on cognitive deficits in preclinical AD models. Despite the promising profile of cotinine, it can only exert its full potential in presence of sufficient levels of endogenous ligands. Beneficial co-treatment effects could be achieved by AChEIs in combination with PAMs, which the former increasing the synaptic concentration of ACh and the latter potentiating alpha7nAChR-signalling.

In AD, not only amyloid plaques but also cholinergic deficits and neuroinflammation contribute to the molecular origin of cognitive decline and disease burden. The approach presented here may tackle all three patho-mechanisms by boosting the cholinergic neurotransmission in a synergistic way using cotinine and galantamine, which, in addition, have anti-aggregation as well as immunomodulatory properties. Thus, the aim of this study is to pin down synergistic effects of chronic co-treatment using the PAM cotinine in combination with the AChEI galantamine. Single and combined preclinical therapeutic efficacy of both components is evaluated in APP-transgenic rats with endpoints in (i) information processing, cognition and memory in vivo (see Figure) and (ii) amyloid plaque load and neuroinflammatory markers ex vivo.

The McGill-R-Thy1-APP rat model of AD-like amyloidosis, expressing human APP displays early cognitive deficits and pre-plaque neuroinflammation followed by progressive amyloid plaque deposition starting at 6 months of age. Comprehensive studies showed that the progressive cognitive decline is accompanied by a reduction in cholinergic synaptic boutons, neuronal loss as well as hippocampal shrinkage.

In this study, McGill-R-Thy1-APP rats (5-month-old/pre-plaque stage) receive either the single compounds or a combination of galantamine and cotinine via drinking water for 94 days. Sensorimotor function (information processing), behavioral flexibility, attention (cognition) and object recognition (memory) are assessed in vivo by using both, classical and automated behavioral assays. Amyloid deposition load and markers of neuroinflammation are quantified ex vivo using a 3D reference atlas of the rat brain.

Compared to administration of either cotinine or galantamine alone, we expect potentiated benefits by a combined treatment with both compounds, resulting in improved working- as well as episodic-like memory, attention and information processing. Additionally, we anticipate reduced amyloid plaque burden and neuroinflammation after chronic co-treatment.

Based on this comprehensive study design we assume to present first results describing the effect of a synergistic modulation of the cholinergic system on a behavioral as well as molecular level.

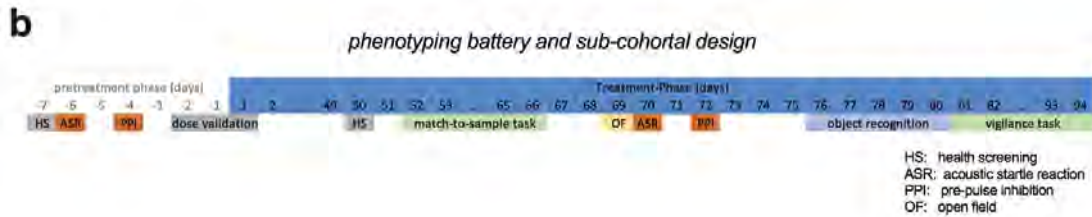
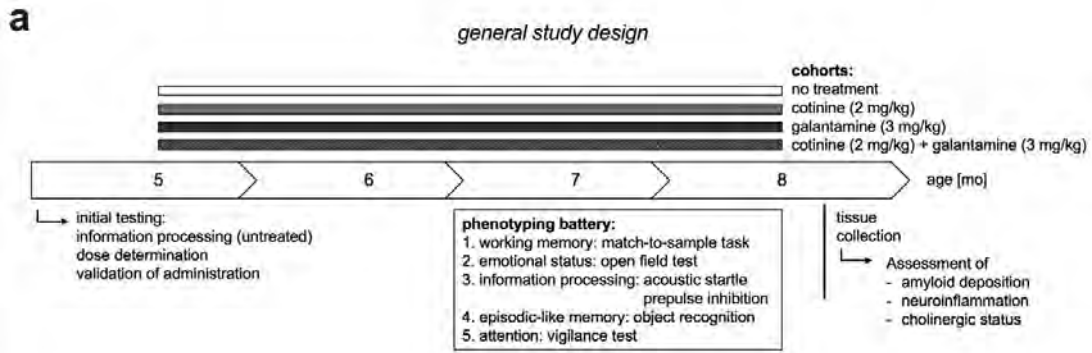

Assessment of information processing, emotional status, memory, amyloid deposition and neuroinflammation after chronic co-treatment with galantamine and cotinine in the McGill-R-Thy1-APP rat model of AD-like amyloidosis. a. General study design including in vivo and ex vivo analysis. b. Phenotyping battery including health screening (HS) and assessment of acoustic startle reaction (ASR), pre-pulse inhibition (PPI), working memory in a match-to-sample-task, behavior in an open field (OF), episodic-like memory using object recognition and attention in a vigilance test during a treatment period of 94 days.

Cerebellar network in a model of paroxysmal dystonia

Fabiana Santana Kragelund¹, Denise Franz¹, Marco Heerdegen¹, Anika Lüttig², Stefanie Perl², Angelika Richter², Rüdiger Köhling¹

¹University of Rostock, Oscar Langendorff Institut für Physiologie, Gertrudenstraße 9, 18057 Rostock, Germany

²University of Leipzig, Institute of Pharmacology, Pharmacy and Toxicology Faculty of Veterinary Medicine (VMF), Leipzig, Saxony, Germany

Dystonia is a neurological syndrome that alters muscle control for voluntary movement and sustained posture. Although the basal ganglia play a role in dystonia, an abnormal cerebellar function is also involved. Deep brain stimulation (DBS) is a standard treatment option for drug-refractory dystonia, and the most promising targets are the Globus Pallidus internus (GPi) or the subthalamic nucleus. The mechanisms of DBS, however, are as yet unclear. In this context, we were interested in the impact of DBS on cerebellar activity and, specifically, the role of glutamatergic transmission in DBS-induced changes.

We explored this question in a genetic animal model of primary paroxysmal dystonia (dtsz mutant hamster) and appropriate controls, bilaterally implanted with bipolar DBS electrodes in the entopeduncular nucleus (homolog to the GPi in humans).

The dtsz hamster is known for alteration in the ganglia–thalamocortical circuit, cortico-striatal circuit, and limbic structures. These further support us in investigating the cerebellum network, especially the synapse plasticity and the expression of NR2A subunits of NMDA since we already know that the NR2A/NR2B ratio is increased in the striatum of dystonic hamsters.

To gauge cerebellar activity, parasagittal slices were recorded with a high-density microelectrode array (200 µm thick) (HD-MEA; 3Brain AG). To analyze the involvement of the glutamatergic system, cerebellar slices were treated with 50 µM of PEAQX, an antagonist selective GluN2A, and their activity compared to baseline recordings in Krebs solution (10 minutes, 2 mL/min, at room temperature).

Our previous results indicate that blocking the NMDA receptor with PEAQX might modulate the Purkinje cell spike firing concerning amplitude and frequency differentially between the DBS and sham-DBS groups.

Acknowledgment This study was supported by the German Research Foundation (DFG) within the Collaborative Research Centre (SFB 1270/1 ELAINE 299150580). We also thank Tina Sellmann and Anna Einsle for all their support.

Changes in inhibitory glycine receptors function in the nucleus accumbens in an Alzheimer's Disease animal model

Luis Aguayo¹, Scarlet Gallegos¹, Anibal Araya¹, Alejandra Guzmán¹, Macarena Konar-Nie¹, Eduardo Fernandez-Perez¹, Lorena Armijo-Weingart¹

¹University of Concepcion, Physiology , Arco Building, room 40, 00001 Concepcion, Chile

It is well known that Alzheimer's disease (AD) is accompanied by alterations in cognitive and non-cognitive cerebral functions. Recent studies have implicated limbic regions, such as the nucleus accumbens (nAc) and the amygdala. Previous studies have shown the presence of inhibitory glycine receptors (GlyRs) in the nAc, whose activation is allosterically modulated by ethanol. Furthermore, in a previous study using the APP/PS1 mice model (6-month-old), we found decreased GlyRs expression and function in the nAc. Our global working hypothesis is that GlyRs alterations in AD affect nAc functions and reward-related behaviors. We examined calcium homeostasis using the calcium fluorescent protein reporter GCaMP. To assay calcium-related signals, we electrically stimulated nAc and measured calcium responses using slice photometry. Increases in fluorescence were observed after adding the GlyRs antagonist (strychnine 1-4 μ M). Interestingly, the effect of strychnine was significantly reduced in the APP/PS1 mice. Using patch clamp technique in brain slices, we compared GlyRs function and the modulation of GlyRs by ethanol, finding that ethanol potentiation was significantly decreased in AD mice. Finally, we performed drinking in the dark (DID) experiments and found that APP/PS1 mice consumed significantly less ethanol on the last day of DID, consistent with lower blood ethanol concentration. We found that APP/PS1 mice also had lower sucrose consumption. Collectively, these data support the important role of GlyRs in nAc neuron excitability; decreased glycinergic activity in the APP/PS1 mice might lead to impairment in reward processing.

Developmental stage-specific analysis of molecular disease mechanisms in genetic epileptic encephalopathies linked to HCN1 channels

Jacquelin Kasemir^{1,2}, Andrea Merseburg^{1,2}, Bina Santoro³, Dirk Isbrandt^{1,2}

¹University and University-Clinic of Cologne, Germany, Institute of Molecular and Behavioral Neuroscience

²German Center for Neurodegenerative Diseases (DZNE), Bonn

³Department of Neuroscience, Mortimer B. Zuckerman Mind Brain Behavior Institute, Columbia University, New York, USA

De novo mutations in voltage- and ligand-gated channels have been associated with an increasing number of cases of developmental and epileptic encephalopathies, which often fail to respond to classic antiseizure medications. Here, we examine two knock-in mouse models replicating de novo sequence variations in the human *HCN1* (hyperpolarization-activated cyclic nucleotide-gated cation channel) gene, p.G391D and p.M153I (*Hcn1*^{G380D/+} and *Hcn1*^{M142I/+} in mouse), associated with severe drug-resistant neonatal- and childhood-onset epilepsy, respectively. Heterozygous mice from both lines displayed spontaneous generalized tonic-clonic seizures. Animals replicating the p.G391D variant had an overall more severe phenotype, with pronounced alterations in the levels and distribution of HCN1 protein, including disrupted targeting to the axon terminals of basket cell interneurons. In line with clinical reports from patients with pathogenic *HCN1* sequence variations, administration of the antiepileptic Na⁺ channel antagonists lamotrigine and phenytoin resulted in the paradoxical induction of seizures in both mouse lines, consistent with an impairment in inhibitory neuron function. We also show that these two variants can render HCN1 channels unresponsive to classic antagonists, indicating the need to screen mutated channels to identify novel compounds with diverse mechanism of action. Additionally, *in vivo* depth recordings of cortical and hippocampal network activity patterns will help us to identify developmental time points and brain regions in which epileptic seizures appear for the first time.

Our results underscore the necessity of tailoring effective therapies for specific channel gene variants, and how strongly validated animal models may provide an invaluable tool toward reaching this objective.

Distribution of the effect of botulinum neurotoxin-A in the rat brain after its experimental unilateral injection into the striatum for experimental Parkinson's disease treatment

Alexander Hawlitschka¹, Oliver Schmitt², Andreas Wee¹, Friederike Schümann³

¹Rostock University Medical Center, Institute of Anatomy, Gertrudenstraße 9, 18057 Rostock, Germany

²Medical School Hamburg, Am Kaiserkai 1, 20457 Hamburg, Germany

³University Hospital for Children and Adolescents, Ernst-Heydemann-Straße 8, 18057 Rostock, Germany

In Parkinson's disease (PD) a degeneration of dopaminergic neurons in the substantia nigra leads to a loss of dopaminergic inhibitory signals to cholinergic interneurons in the striatum. This leads to a striatal hypercholinism, which is responsible for a large part of the motor deficits typical for PD. Pharmacological treatments with centrally acting anticholinergics have very good antiparkinsonian effects, but have many severe side effects too. To avoid these side effects while benefiting from the excellent antiparkinsonian effect of anticholinergic therapy, we are exploring the experimental application of Botulinumneurotoxin-A (BoNT-A) in the striatum using PD animal models.

Here, we aimed to estimate the duration of the enzymatic activity of intrastrially injected BoNT-A and to determine its spread within the brain. Therefore rats were injected unilaterally with 1 ng BoNT-A into the right striatum, and their brains were examined at two weeks, one month, 3 months, 6 months, 9 months and 12 months after treatment. Immunohistochemical stainings for cleaved synaptosomal-associated protein 25 (SNAP-25), the cleavage product of BoNT-A, were performed on 30 µm thick brain sections. These sections were visualized with diaminobenzidine and analysed densitometrically for the distribution of cleaved SNAP-25. The dynamics with which the immune reactivity against cleaved SNAP-25 develops were investigated. We performed correlation analyses of the densitometry data with the connectivity of the brain areas studied and their distance from the treated striatum.

We have obtained clear evidence for axonal transport for BoNT-A to various brain areas after its injection into the striatum. After a single BoNT-A-injection into the striatum an increased immunoreactivity against cleaved SNAP-25 was found in the olfactory bulb, nearly all other parts of the basal ganglia, the medial forebrain bundle, the piriform cortex, the amygdala, the motor cortex and the pons. In some brain regions, immune reactivity was increased even in the contralateral hemisphere, for example in the olfactory bulb and the basolateral amygdala. A linear relationship between the distance of the investigated brain areas from the injection site and the time for achievement the maximal mean immunoreactivity was found. A similar relationship was proven for the distance to the injection site and the maximum immunoreactivity as well as for the connection density and the maximum immunoreactivity. An enzymatic activity of BoNT-A in the brain, especially in the substantia nigra, could still be measured one year after treatment.

Effects of the Medial Septum electrical stimulation on okadaic acid induced spatial long-term memory impairment: a behavioral and histological evaluation

Mariam Chighladze¹, Maia Burjanadze¹, Manana Dashniani¹, Nino Chkhikvishvili¹, Lali Kruashvili¹

¹Ivane Beritashvili Center of Experimental Biomedicine, Laboratory of Behavior and Cognitive Functions, Gotua Street 14, 0160 Tbilisi, Georgia

Purpose: There is growing evidence from laboratory and clinical trials that deep brain stimulation (DBS) at memory associated structures enhances cognitive functions. Best site for memory enhancing-DBS is still unclear. The medial septum (MS), the important modulator of the hippocampal neural network, might be a key target to accomplish therapeutic efficacy in memory impaired patients. In present study we used the rat model of dementia induced by intracerebroventricular (ICV) injection of okadaic acid (OA) to confirm the effects of MS DBS on spatial memory function.

Methods: The male rats - aged 5 months, was randomly assigned to four experimental groups: 1. Control (ICV injected of artificial cerebrospinal fluid - aCSF), 2. OA (ICV injected of OA; OA was dissolved in aCSF and injected ICV 200 ng in a volume of 10 μ l bilaterally), 3. OA/I (ICV injected of OA and implantation of an electrode) and 4. OA/S (ICV injected of OA, implantation of an electrode and electrical stimulation). In the chronic DBS experiment, animals received stimulation (60 Hz, 60 μ s, 50 μ A) 2 hr daily for a period of 2 weeks. Learning process and memory function were assessed using a Morris water maze (MWM). The test consisted of a training phase (days 4–7; four trials per day) and a retrieval phase. At the end of the behavioral experiments, six rats from each group were used by random sampling in the histological studies. Cresyl violet staining was performed to confirm the location of electrode. Statistical analysis was performed using ANOVA.

Results: In behavioral experiments was assessed acquisition of a spatial memory and its subsequent recall in the MWM. The results showed that all rats exhibited a decreased latency to find the hidden platform across the training trials. During the probe test which was performed 24 hours after task acquisition trained rats of Control and OA/S groups showed normal spatial memory abilities, however rats of OA and OA/I groups showed impaired spatial reference memory in the maze. The results suggest that rats of OA and OA/I groups could not remember the information acquired during training 24 h later and DBS of MS restores long-term spatial memory. Using immunohistochemical approaches, we found that OA ICV administration reduced the number of parvalbumin immunoreactive MS neurons by 23% and the number of cholinacetyltransferase immunoreactive neurons by 25% vs. control group. Our results also showed a significant reduced AChE staining in hippocampus in OA and OA(I) groups as compared to sections obtained from Control group. Nissl staining of hippocampal sections showed that the number of pyramidal cells in the CA1 and CA3 regions in the control and OA(S) groups is significantly higher than that in the OA and OA(I) groups. In MS stimulation group number of AChE-sensitive neurons, as well as the total number of pyramidal neurons in the hippocampus was not different from the control group.

In summary, our results revealed that DBS of MS restores OA induced spatial long-term memory impairment. It can be assumed that cholinergic and GABAergic deficits in MS after OA administration are

compensated by stimulation of surviving septo-hippocampal projection neurons and that the effect of MS DBS on memory improvement is associated with the modulation of hippocampal cholinergic activity and prevention of neuronal loss in the hippocampus.

Supported by the funding from the SRNSFG: Grant #-YS-21-1235

Elucidating early molecular events of human cortical ALS pathophysiology at single cell resolution

Zeynep Irem Gunes¹, Klara Magdalena Eglseer^{1,3}, Charlene-Annett Hurler⁵, Sarah Jaekel^{4,5}, Eduardo Beltran^{1,3,4}, Thomas Arzberger^{4,6}, Sabine Liebscher^{1,2,3,4}

¹Institute of Clinical Neuroimmunology, Klinikum der Universität München, Ludwig-Maximilian-University Munich, Emmy Noether Research Group, Grosshaderner Strasse 9, 82152 Martinsried, Germany

²Graduate School of Systemic Neurosciences, Ludwig-Maximilian-University Munich BioCenter, Department Biology II Neurobiology, Großhaderner Str. 2, 82152 Martinsried, Germany

³Biomedical Center, Ludwig-Maximilian-University, Grosshaderner Strasse 9, 82152 Martinsried, Germany

⁴Munich Cluster for Systems Neurology (SyNergy), Feodor-Lynen-Straße 17, 81377 Munich, Germany

⁵Institute for Stroke and Dementia Research, University Hospital, Ludwig-Maximilian-University Munich, Feodor-Lynen-Straße 17, 81377 Munich, Germany

⁶Center for Neuropathology and Prion Research, Ludwig-Maximilian-University Munich, Feodor-Lynen-Straße 23, 81377 Munich, Germany

Amyotrophic lateral sclerosis (ALS) is a fatal neurodegenerative disease, primarily affecting motor neurons in motor cortex and spinal cord. Cytoplasmic mislocalization and aggregation of the TAR DNA binding protein 43 kDa (TDP-43) is a hallmark of the disease and believed to be at the heart of neurodegeneration, triggering a consecutive glial reaction. It, however, is still debated whether TDP-43 aggregates are causal to neuronal death or rather an indicator of the degenerative process per se; and which sequence of cellular and molecular events underly the final neurodegeneration.

Notably, in the brain pTDP-43 is first observed in motor cortex, from where it spreads in a corticofugal manner, allowing for neuropathological staging. To elucidate early cell-type specific events in the disease, we identified sporadic (n=4) and familial (n=5, *C9orf72*) ALS cases (mean age 67 y), with Braak stage 1 neuropathology, characterized by classical pTDP-43 pathology in motor cortex, while the adjacent frontal cortex lacks pTDP-43 inclusions. We obtained postmortem snap-frozen samples from motor and frontal cortex of these ALS cases and age-, sex-matched neurologically unaffected controls (n=5, mean age 72 y) and performed single nuclei RNA sequencing. Unexpectedly, our preliminary analysis revealed a striking reaction of all glial cell types not only in the affected motor cortex, but already within the pTDP-43 lacking frontal cortex. Various DEGs of microglia, astrocytes and oligodendrocytes could be identified, indicating a 'damage-response', that precedes neuronal pTDP-43 pathology. Promising candidates are currently validated and explored for their role in disrupted cell-autonomous function and cell-cell communication in ALS.

Excitability changes in hippocampal neurons in the rodent models of Alzheimer's disease and a way to prevent it

Liudmila Sosulina¹, Hiroshi Kaneko¹, Anja M. Oelschlegel², Katarzyna M. Grochowska^{2,3},
Guilherme M. Gomes^{2,4}, Carsten Reissner⁵, Manuel Mittag⁶, Martin Fuhrmann⁶, Anna
Karpova^{2,4}, Michael R. Kreutz^{2,3,4,7}, Stefan Remy^{1,4,7}

¹Leibniz Institute for Neurobiology (LIN), Department of Cellular Neuroscience, Magdeburg, Germany

²Leibniz Institute for Neurobiology (LIN), RG Neuroplasticity, Magdeburg, Germany

³Center for Molecular Neurobiology (ZMNH), University Medical Center Hamburg-Eppendorf, Leibniz Group 'Dendritic Organelles and Synaptic Function', Hamburg, Germany

⁴Center for Behavioral Brain Sciences (CBBS), Otto von Guericke University, Magdeburg, Germany

⁵Institute of Anatomy and Molecular Neurobiology, Westfälische Wilhelms-University, Muenster, Germany

⁶German Center for Neurodegenerative Diseases (DZNE), Neuroimmunology and Imaging Group, Bonn, Germany

⁷German Center for Neurodegenerative Diseases (DZNE), Magdeburg, Germany

Early hippocampal hyperexcitability is known to be present in patients and different transgenic Alzheimer's models. Cellular and intracellular cascades and processes of this phenomenon are poorly understood. Intrinsic neuronal excitability was investigated in CA1 hippocampal neurons in vitro in McGill-APP-rats and TBA2.1 mice. Additionally, in TBA2.1 mice we performed Nitarsone treatment (50 mg/kg) over a period of six weeks in vivo and compared intrinsic excitability with control groups.

We observed increased intrinsic excitability of pyramidal neurons in McGill-APP-rats and TBA2.1 mice, as well as disruption of positive correlation between input resistance and action potential half width duration in disease conditions. Feeding of transgenic mice with Nitarsone, a small compound which restores CREB transcriptional activity, despite the presence of amyloid pathology, rescues this positive correlation.

Our data suggest that prevention of the CREB shut-off in AD models might be an effective way to slow down early synaptic failure in AD.

Expression profiling and functional characterization of candidate MicroRNA associated with frontotemporal dementia

Lalit Kaurani¹, Jiayin Zhou¹, Ranjit Pradhan¹, Aditi Methi¹, Susanne Burkhardt¹, Raquel Pinto², MD Rezaul Islam¹, Sophie Schröder¹, Peter Heutink³, Farahnaz Sananbenesi¹, Andre Fischer^{1,4,5}

¹Department for Systems Medicine and Epigenetics, German Center for Neurodegenerative Diseases (DZNE), Göttingen, Germany

²GGNB Neurosciences-International Max Planck Research School

³German Center for Neurodegenerative Diseases, Tübingen, Germany

⁴Cluster of Excellence "Multiscale Bioimaging: from Molecular Machines to Networks of Excitable Cells" (MBExC), University of Göttingen, Germany

⁵Department of Psychiatry and Psychotherapy, University Medical Center Göttingen, Göttingen, Germany

Cognitive dysfunction is a key pathological indicator of various psychiatric and neurodegenerative disorders. Consequently, there is an urgent need for biomarkers that can predict the future risk of cognitive impairments. MiRNAs have been identified as being involved in the aging process and as potential biomarkers of neurodegenerative disease progression. Frontotemporal dementia (FTD) is the one of the most prevalent forms of dementia after Alzheimer's disease, and it shares pathophysiological mechanisms and genetic origins with a number of dementia-specific disorders. FTD-linked microRNA mining can be used to differentiate FTD from other dementia-specific disorders. In this study, we performed a comprehensive smallRNAome sequencing analysis of frontal and temporal cortex tissue to identify microRNAs that were dysregulated in a subset of FTD patients. Further investigation was carried out by manipulating one of these candidate microRNAs in vitro to reflect the molecular changes that occur during brain pathology. Manipulation of a candidate microRNA marker resulted in cognitive impairment in animals, suggesting its use as a potent pathogenetic indicator of FTD disorders.

Extracellular matrix changes in subcellular brain fractions and biofluid of Alzheimer's disease patients

Lukas Höhn^{1,2}, Wilhelm Hußler^{1,2}, Anni Richter¹, Karl-Heinz Smalla^{1,3}, Anna-Maria Birkli-Töglhofer⁶, Christoph Birkli⁶, Stefan Vielhaber^{2,3}, Stefan L. Leber⁷, Eckart D. Gundelfinger^{1,3,4}, Stefanie Schreiber^{2,3,5}, Johannes Haybäck⁶, Constanze I. Seidenbecher^{1,3}

¹Leibniz Institute for Neurobiology (LIN) Magdeburg, Brenneckestraße 6, Germany

²Department of Neurology, Otto-von-Guericke University, Magdeburg, Germany

³Center for Behavioral Brain Sciences (CBBS) Magdeburg, Germany

⁴Institute for Pharmacology and Toxicology, Otto-von-Guericke-University Magdeburg, Germany

⁵German Center for Neurodegenerative Disorders (DZNE) Magdeburg, Germany

⁶Institute of Pathology, Neuropathology and Molecular Pathology, Medical University of Innsbruck, Müllerstraße 44, 6020 Innsbruck, Austria

⁷Division of Neuroradiology, vascular and interventional Radiology, Medical University of Graz, Auenbruggerplatz 9, 8036 Graz, Austria

Alzheimer's Disease (AD) is a severe neurological condition characterized by impaired synaptic plasticity, amyloid plaques and neurofibrillary tangles leading to brain atrophy. The neural extracellular matrix (ECM), a macromolecular meshwork of glycoproteins, proteoglycans, link proteins, and hyaluronan, was reported to undergo rearrangements in human AD brains as well as in animal models for AD.

Therefore, in this study, we investigated changes of key components of the neural hyaluronan-based ECM in post mortem brain material and cerebrospinal fluid (CSF) of AD patients and non-demented controls. We prepared soluble and synaptosomal fractions from tissue sample homogenates of the frontal (FC) and temporal cortex (TC) and of the hippocampus (HC) of 19 tissue donors (7 controls, 4 low AD with Braak stages 1-2, 8 high AD with Braak stages 4-6) not significantly differing in age, sex and post mortem interval, and quantified the presence of major ECM components by immunoblot analysis.

We performed group comparisons and Spearman correlation analyses and observed a reduction of brevican in TC soluble fractions and FC synaptosomal fractions in AD. In contrast, neurocan, aggrecan and the link protein HAPLN1 were upregulated in cortical soluble fractions in the patients. RNAseq data from 107 (94 HC, 91 parietal cortex, 99 TC, 93 frontal white matter) subjects from The Aging, Dementia and Traumatic Brain Injury Study (<https://aging.brain-map.org>) showed no correlation between aggrecan and brevican expression levels and Braak or CERAD stages. For HAPLN1 and neurocan expression, however, negative correlations with Braak stages were detected in the HC. These changes in ECM components in various brain areas are seemingly not to be reflected by changes at CSF levels, as neither brevican nor neurocan proteoglycans and their major cleavage products differed between AD and non-demented controls in another cohort of patients (35 AD, 35 controls). Their abundance positively correlated with age, total tau, phospho-tau, neurofilament-L and A β 1-40. Negative correlations were detected with the A β ratio and the IgG index. In accordance with our earlier study in ALS patients (Hußler et al., *Front. Cell. Neurosci.* 2022) CSF concentrations of these lecticans may thus reflect neurodegeneration in general, but are not suitable as AD-specific CSF biomarkers. Taken together, this study reveals spatially segregated molecular rearrangements of the ECM in AD brains at RNA or protein level, which may contribute to the pathogenic

process and, if so, may represent potential new targets for intervention.

This study was supported by the DFG - 362321501/RTG 2413 SynAGE and 425899996/CRC1436. W.H. and L.H. were SynAGE fellows.

Hippocampal low-frequency stimulation suppresses epileptic activity without affecting learning and memory in a mouse model of epilepsy

Enya Paschen^{1,2}, Piret Kleis^{1,2}, Jessica Link¹, Diego M Vieira³, Katharina Heining⁴, Ute Häussler^{1,5}, Carola A Haas^{1,5}

¹Experimental Epilepsy Research, Department of Neurosurgery, Medical Center - University of Freiburg, Faculty of Medicine, Freiburg, Germany ²Faculty of Biology, University of Freiburg, Freiburg, Germany ³Biomicrotechnology, Department of Microsystems Engineering – IMTEK, Faculty of Engineering, University of Freiburg, Freiburg, Germany ⁴Department of Neuroscience, Karolinska Institutet, Stockholm, Sweden ⁵BrainLinks-BrainTools Center Freiburg, University of Freiburg, Freiburg, Germany

Mesial temporal lobe epilepsy (MTLE) is the most common form of focal, pharmacoresistant epilepsy in adults and is often associated with hippocampal sclerosis (HS). For MTLE patients, one alternative to surgical resection of the epileptic focus is electrical deep brain stimulation in the hippocampus. Commonly, high-frequency stimulation is applied for seizure interruption but the efficacy is low in the presence of HS. For these patients, low-frequency stimulation (LFS) represents an alternative treatment option to prevent seizure occurrence.

We showed previously in an in vivo mouse model of MTLE that continuous LFS at 1 Hz in the sclerotic hippocampus interferes with the generation of focal, spontaneous epileptiform activity and evoked generalized seizures (Paschen et al., eLife, 2020). Here, we aimed to implement a novel on-demand stimulation protocol and infer the potential impacts of LFS on hippocampal functions such as learning and memory. To this end, we injected kainate or saline unilaterally into the hippocampus of C57BL/6 mice and implanted one electrode for local field potential (LFP) recordings in each hippocampus and a stimulation electrode in the sclerotic hippocampus. In the chronic stage of epilepsy, we probed on-demand LFS, compared it to open-loop 1 Hz stimulations, and sequentially investigated mobility and anxiety, as well as spatial learning and memory. For on-demand LFS, we implemented the online detection of epileptiform activity that initiates LFS whenever a threshold in the spike rate is reached. Behavioral tests included the open field, the light-dark box, and the Barnes maze in chronically epileptic and healthy control mice that were either stimulated (30 min, 1 Hz) or not stimulated before each training or test trial.

We found that (i) on-demand LFS was more efficient in the suppression of epileptiform activity than open-loop LFS. (ii) Chronically epileptic mice were more anxious than healthy controls but they were not impaired in their mobility. (iii) LFS did not alter mobility or anxiety either in chronically epileptic or in healthy control mice. (iiii) LFS did not impair spatial learning and memory performance, since despite stimulation mice were able to navigate successfully in the Barnes Maze.

Our results indicate that the reliable hippocampal LFS has a higher efficiency when applied on-demand. Most importantly, it is not affecting mobility and anxiety, or impairing hippocampus-related cognitive functions. Thus, LFS may constitute a promising approach for seizure control in MTLE with HS.

Identification of optimal stimulation targets and parameters to suppress seizures in a mouse model of mesial temporal lobe epilepsy

Piret Kleis^{1,2}, Enya Paschen^{1,2}, Jessica Link¹, Diego M. Vieira³, Katharina Heining⁴, Ute Häussler^{1,5}, Carola A. Haas^{1,5}

¹Experimental Epilepsy Research, Department of Neurosurgery, Medical Center - University of Freiburg, Faculty of Medicine, Freiburg, Germany

²Faculty of Biology, University of Freiburg, Freiburg, Germany

³Biomicrotechnology, Department of Microsystems Engineering – IMTEK, Faculty of Engineering, University of Freiburg, Freiburg, Germany

⁴Department of Neuroscience, Karolinska Institutet, Stockholm, Sweden

⁵BrainLinks-BrainTools Center Freiburg, University of Freiburg, Freiburg, Germany

Mesial temporal lobe epilepsy (MTLE) is the most common form of drug-resistant epilepsy in adults, characterized by focal seizures typically originating from the hippocampus or entorhinal cortex. Deep brain stimulation represents a promising alternative approach to resective surgery for alleviating intractable seizures in MTLE patients. In clinical practice, high-frequency stimulation is applied in the seizure focus or thalamic nuclei to hinder the propagation of seizures. However, it tends to have low seizure-suppressive efficacy in MTLE patients with hippocampal sclerosis, presumably due to extensive neuronal loss and glial scarring. Small cohort studies suggest low-frequency stimulation (LFS) might be a better stimulation strategy for these patients.

Here, we build on our previous preclinical findings showing that 1 Hz LFS of entorhinal afferents in the sclerotic hippocampus prevents spontaneous seizure activity during stimulation in chronically epileptic mice (Paschen et al., *eLife* 2020). However, it is unclear which cell populations mediate these anti-epileptic effects and whether it is possible to minimize the amount of stimulation by adjusting the LFS parameters. Our goal is to determine if the seizure suppressive effect of 1 Hz optogenetic LFS is the strongest when applied to dentate granule cells (DGCs) in (1) the sclerotic dorsal hippocampus, (2) the non-sclerotic ventral hippocampus or (3) to principal cells of the medial entorhinal cortex (MEC). Subsequently, we selected the most suitable target for electrical LFS to improve the parameters. To this end, we applied lognormally distributed 1 Hz stimulation pulses in open-loop and closed-loop modes. In the latter, we monitored interictal activity (epileptiform spikes between seizures) and adjusted the stimulation to reach the target frequency (1 Hz). Moreover, we are testing a personalized stimulation frequency based on the interictal spiking interval of each mouse.

We induced chronic epilepsy in mice by unilateral, intrahippocampal injection of kainate (KA). In the first set of experiments, principal cell populations in MEC or dentate gyrus (DG) were targeted either with a stereotactic injection of a Channelrhodopsin2(ChR2)-encoding viral vector or using a transgenic mouse line (Rbp4-Cre x Ai32), which expresses ChR2 selectively in DGCs. Mice were implanted with a recording electrode in each hippocampus at the level of KA injection. An optic fiber was placed either (1) into the sclerotic DG or, together with an additional recording electrode, into the ipsilateral (2) ventral DG or (3) the MEC. In the second set of experiments, a stimulation electrode was implanted instead of the optic fiber into the sclerotic DG. During the chronic phase of epilepsy, we acquired local field potential recordings from

freely moving mice with or without optogenetic or electric LFS.

We found that the most substantial seizure-suppressive effect was achieved by optogenetic LFS of the DGCs in the sclerotic dorsal hippocampus, whereas stimulation of the DGCs in the non-sclerotic ventral hippocampus or principal cells in MEC only had a subtle effect. We tested various stimulation patterns with electrical LFS in the sclerotic hippocampus and determined that a lognormal distribution of stimulation pulses was as effective as periodic stimulation. We are working towards a closed-loop approach with individualized frequency to minimize the stimulation load but maintain the seizure-suppressive effect of LFS.

Impact of FTY720 on memory performance and hippocampal spines of aged APP/PS1 mice

Lukas Schönwolf¹, Thomas Endres¹, Volkmar Leßmann¹

¹Institute of Physiology, Medical Faculty, Otto-von-Guericke University Magdeburg, Magdeburg, Germany

Alzheimer's disease (AD) is the most common form of dementia. Cognitive decline and an accumulation of A β ; were identified as hallmarks of AD. Nowadays pharmacological treatment regimens can only delay the progression of AD, but they do not stop or even reverse the AD pathology. Therefore, it becomes one of the major challenges of the 21st century to find new pharmacological approaches to treat AD.

Our research project examines the potential positive effects of the FDA approved drug FTY720 (Fingolimod) in a transgenic mouse model for AD. FTY-720 is a Sphingosine-1-phosphate (S1P) receptor modulator, originally designed and approved for treating patients with relapsing multiple sclerosis. The anti-inflammatory effects of FTY720 on lymphocytes, microglia and astroglia suggest that FTY720 could also have a beneficial effect against AD pathology.

To investigate the impact of FTY720 on AD pathology, we treated aged, i.e. 15 months old, APP/PS1 mice chronically with two different dosages of FTY720. Subsequently, we tested spatial learning by a Morris water maze (MWM) task and contextual fear learning. As FTY720 has been described to elevate BDNF (Brain-derived neurotrophic factor) levels in the brain, we also analyzed the BDNF-levels in the cortex and the hippocampus of the treated transgenic mice. Furthermore, we quantified hippocampal spine densities in relation to the distances to senile plaques by using a combined Methoxy X04/Golgi-Cox staining.

Our first results revealed that FTY-720 dose-dependently restores contextual fear memory, while it fails to restore spatial learning in the MWM task. In addition, it could reverse the deficits in spine densities observed in CA1, CA3 and DG regions of the hippocampus. Currently we are analyzing the BDNF protein levels of the tested animals. Overall, our data further supports the idea that the already FDA-approved drug possess beneficial off-target effects against AD pathology.

This study was supported by the DFG: RTG 2413 SynAGE.

Impact of TDP-43 pathology and ER stress on cortical neuronal health *in vivo*

Shenyi Jiang^{1,2,3}, Riddhi Sandeep Petkar^{1,3}, Monica Liliana Ziegler^{1,3}, Smita Saxena^{4,5},
Sabine Liebscher^{1,3,6}

¹Institute of Clinical Neuroimmunology, Klinikum der Universität München, Ludwig - Maximilians University Munich, Munich, Germany

²Graduate School of Systemic Neurosciences, Ludwig - Maximilians University Munich, Munich, Germany

³Biomedical Center, Ludwig - Maximilians University Munich, Munich, Germany

⁴Department of Neurology, Inselspital, University Hospital, Bern, Switzerland

⁵Department for BioMedical Research, University of Bern, Bern, Switzerland

⁶Munich Cluster for Systems Neurology (SyNergy), Munich, Germany

Protein aggregation and ER stress are two common pathological features across different neurodegenerative diseases. In Amyotrophic lateral sclerosis (ALS), cytoplasmic TDP-43 mislocalisation and aggregation in neurons are a classical hallmark of the disease, observed in almost all patients' brains with very few exceptions. These proteinaceous aggregates co-occur with the upregulation of genes typical of the unfolded protein response (UPR) pathways, indicating the presence of ER stress in neurons. Accumulating evidence suggests that ER stress plays an important role in protein misfolding and aggregation, while these pathological proteins can in turn exacerbate the cellular stress condition. However, a causal relationship between those molecular changes and how they might cause an impairment of neuronal health, as well as the underlying time course remain to be conclusively elucidated. To this end, we here assess the impact of chronic ER stress and TDP-43 pathology, respectively, on neuronal structure and function in living mice by means of longitudinal *in vivo* two-photon imaging. To induce chronic ER stress, we chronically administered low-dose Tunicamycin into adult GFP-M mice, which sparsely express eGFP in cortex in layer V pyramidal neurons. We performed chronic *in vivo* imaging to monitor the plasticity of dendritic spines, the structural correlates of postsynapses. We found a reduction of synaptic plasticity (spine dynamics) under ER stress. Interestingly, this impaired plasticity was mainly driven by the decreased formation of new spines and not primarily by a loss of existing ones. These data suggest that the potential halt of protein synthesis triggered by ER stress initially affects spine formation and thus structural plasticity, while sparing mature synapses. To next investigate the impact of TDP-43 pathology on neuronal structure and function *in vivo*, we generated various constructs of TDP-43 allowing us to separate its role in various subcellular compartments (including wildtype TDP-43 that mainly expresses in the nucleus, TDP-43 with mutations in the nuclear localisation sequence that stays in the cytoplasm, and RNA-binding deficient cytoplasmic TDP-43 that showed aggregate formation in cultured cells in previous study). AAV-mediated neuronal expression of these TDP-43 constructs clearly demonstrate that nuclear overexpression of human wildtype TDP-43 is highly detrimental causing rapid neuronal death, despite lacking cytoplasmic mislocalisation and aggregation. Conversely, cytoplasmic TDP-43 or cytoplasmic TDP-43 with RNA binding deficiency do not trigger rapid neurodegeneration. Further chronic imaging experiments are performed to probe a potential impact on structural plasticity and neuronal function in this context. Assessing microglia morphology and motility in response to the expression of the different TDP-43 constructs mirrors the level of neurodegeneration we observe. These results raise the concern of using models based on the overexpression of nuclear TDP-43 in ALS research, as it may trigger neuronal degeneration through

mechanisms unrelated to the human pathophysiology, in which TDP-43 is depleted from the nucleus.

Investigation of mitochondrial protein-import stress induced neuronal degeneration

Johannes Ebding¹, Marlene Barth¹, Maximilian Goy¹, Adrian Gackstatter¹, Martin Simon³,
Johannes Herrmann², Jan Pielage¹

¹University of Kaiserslautern, Department of Neurobiology and Zoology, Germany

²University of Kaiserslautern, Department of Molecular Cell Biology, Germany

³Wuppertal University, Department of Molecular Cell Biology and Microbiology, Germany

The maintenance of organelle and membrane compartment identity and function under stress conditions is essential for all complex organisms. Neurons are particularly well-suited for the investigation of stress responses as they represent one of the most complex cell types in animals and individual neurons must be maintained over the lifetime of an organism. Neurons have long axons separating soma and synapses with synaptic terminals showing one of the highest cellular rates of mitochondrial based energy consumption. Mitochondrial dysfunction is associated with multiple neurodegenerative diseases, however the precise molecular and cellular links between mitochondrial defects and neuronal degeneration remain largely elusive. To address the relationship between mitochondrial stress and synaptic integrity, we established a mitochondrial protein import (MPI)-stress model in *Drosophila* motoneurons. We used cellular, immunohistochemical, and transcriptomic approaches to identify the cellular mechanisms underlying the synaptic degeneration caused by impaired mitochondrial protein import. Here, we will present first insights into the transcriptional and cellular programs potentially contributing to progressive neurodegeneration in these conditions.

Loss of interneurons in the subiculum in a mouse model for mesial temporal lobe epilepsy

Nicole Barheier^{1,2}, Julia Franz¹, Henrike Wilms¹, Susanne Tulke¹, Carola A. Haas^{1,3,4},
Ute Häussler^{1,4}

¹Experimental Epilepsy Research, Department of Neurosurgery, MedicalCenter - University of Freiburg, Faculty of Medicine, 79106 Freiburg, Germany

²Faculty of Biology, University of Freiburg, 79104 Freiburg

³Center for Basics in NeuroModulation, Faculty of Medicine, University of Freiburg, 79106 Freiburg, Germany

⁴BrainLinks-BrainTools, University of Freiburg, 79110 Freiburg, Germany

Mesial temporal lobe epilepsy (MTLE) is characterized by a loss of principal cells in the hilus, CA1 and CA3, as well as interneurons throughout the hippocampus and by the occurrence of epileptic activity which is resistant to pharmacological treatment. Whereas the hippocampus has been intensely investigated, data on structural changes in the subiculum, which is the main output region of the hippocampal formation, are rare. Yet, its connectivity and cellular characteristics, in particular the presence of burst-firing cells, might render the subiculum an important part of the epileptic network. Based on our previous work showing differential vulnerability of interneurons in the hippocampus, we now performed a detailed study of epilepsy-related changes in the subiculum.

Using the intrahippocampal kainate (KA) mouse model for MTLE which recapitulates the main characteristics of the human disease, we tested whether epileptic activity also occurs in the subiculum by local field potential recordings. Next, we analyzed neuronal loss after the initial status epilepticus with Fluoro-Jade C staining and NeuN immunocytochemistry. Furthermore, we determined glutamic acid decarboxylase (GAD) 67 expression with fluorescent *in situ* hybridization and performed quantitative immunocytochemistry for different interneuron populations (parvalbumin, Neuropeptide Y (NPY) and calretinin) across all layers along the dorsoventral axis of the subiculum and in the chronic stage of MTLE (21 days after KA) in male and female mice.

We found that epileptic activity did not only occur in the hippocampus, but concomitantly also in the subiculum. We observed neuronal loss in middle and superficial layers of the proximal and distal subiculum at the injection site and more dorsal. Quantification of GAD67-positive interneurons revealed a reduction by about ~50%, which was comparable between males and females. The effect of a decreased density of parvalbumin-expressing interneurons was observed in superficial to deep layers of the subiculum along the dorsoventral axis, but diminished towards the ventral level. In contrast, calretinin-expressing neurons were mainly lost at the injection site. Interestingly, the number of NPY-expressing cells was increased, yet NPY- and GAD67-doublelabeled cells were reduced, indicating interneuron loss but NPY upregulation in principal cells. In summary, our results show a loss of the three subpopulations of interneurons (parvalbumin-, calretinin- and NPY-positive interneurons) which could contribute to epileptogenicity in the subiculum after KA injection.

Metabolic and cellular factors determining the therapeutic effect of dimethyl fumarate

Joanna Maria Kosinska¹, Julian Assmann¹, Julica Folberth¹, Markus Schwaninger¹

¹University of Lübeck, Institute for Experimental and Clinical Pharmacology and Toxicology, Ratzeburger Allee 160, 23562 Lübeck, Germany

Multiple sclerosis (MS) is an autoimmune disease of the central nervous system, in which the interaction between a variety of immunopathological and neuropathological mechanisms leads to inflammation, demyelination, axonal loss and gliosis. In MS therapy, the drug dimethyl fumarate (DMF) has been shown to improve neurological symptoms but unfortunately, not all patients respond to the drug. The active metabolite of DMF is monomethyl fumarate (MMF), which is an agonist of the hydroxycarboxylic acid receptor 2 (HCA2) along with butyrate, a short chain fatty acid (SCFA) produced by the microbiome. We reasoned that the response to DMF may depend on the endogenous production of butyrate. To modulate butyrate production, we fed mice with high-fiber diet (HFD), lauric-acid-rich diet (LAD), or with normal chow (NC) and subjected them to experimental autoimmune encephalomyelitis (EAE), an animal model of MS. Interestingly, DMF had the biggest therapeutic effect on neurological deficits when mice were fed with HFD but it had no effect on LAD. Plasma levels of MMF were not affected by the diet. When mice were fed with HFD, the DMF effect depended on HCA2 as reported previously. HFD induced the expression of HCA2 in Ly6C^{intermediate} monocytes and in microglia, whereas neutrophils expressed HCA2 at a high level irrespective of the diet. To investigate the function of HCA2 in neutrophils and in brain endothelial cells we employed a conditional knockout approach. In *Ly6G-Cre Hca2^{F1/F1}* mice, HCA2 was deleted in neutrophils and the therapeutic effect of DMF was lost suggesting that DMF exerts its therapeutic effect by activating HCA2 in neutrophils. Current work tries to elucidate how HFD modulates the sensitivity of neutrophils to MMF stimulation. At the clinical level, our data suggest a strategy to increase the response rate to DMF.

Phosphorylation-state dependent intraneuronal sorting of A β differentially impairs autophagy-endo-lysosomal system and ubiquitin proteasomal machinery

Akshay Kapadia¹, Sandra Theil¹, Sabine Opitz^{2,3}, Nàdia Villacampa², Susanne Schoch-McGovern³, Michael. T. Heneka², Sathish Kumar¹, Jochen Walter¹

¹Department of Neurology, University Hospital Bonn, Bonn, Germany

²Neuroinflammation Unit, German Center for Neurodegenerative Diseases e. V. (DZNE), Bonn, Germany

³Section for Translational Epilepsy Research, Department of Neuropathology, University Hospital Bonn, Bonn, Germany

Post-translational modifications (PTMs) of proteins/peptides play a critical role in nearly all aspects of biological processes by regulating protein functions. Aberrant PTMs of one or more culprit proteins are implicated in neurodegenerative diseases including Alzheimer's disease (AD).¹ The tau protein and amyloid- β (A β) peptides present in the brains of AD patients have been shown to undergo various PTMs, that can modulate their metabolism and aggregation²⁻⁴ We previously showed that A β undergoes phosphorylation at serine residues 8 and 26 by distinct protein kinases,^{5,6} affecting aggregation behaviour, biostability and deposition in comparison to the non-phosphorylated peptide.⁵⁻⁸

Here, we assessed the effect of A β phosphorylation on neuronal homeostasis and quality control machinery. Phosphorylated A β species were detected in brains of APP/PS1 Δ E9-Thy1-YFP transgenic mice and found to correlate with dysregulated expression of the autophagy-endo-lysosomal pathway (ALP) as well as ubiquitin proteasomal system (UPS)-related proteins. Cell biological studies revealed the differential uptake and sorting of phosphorylated A β variants, and phosphorylation-state specific effects of A β variants on neuronal autophagy, lysosomal and proteasomal function. A β phosphorylated at serine residue 8 impaired autophagic flux, lysosomal acidification, activity of cathepsin D and E, and enhanced proteasomal function. On the other hand, A β phosphorylated at serine residue 26 rather showed an increase in autophagosomal maturation, enhanced lysosomal acidification, cathepsin and proteasomal activity.

Our results indicate the importance of phosphorylated A β species in intraneuronal A β accumulation, and dysregulation of intraneuronal degradation pathways. Thus, the relative occurrence of phosphorylated A β species and their intraneuronal accumulation could contribute to AD pathogenesis, and to the commonly observed aberrations of the vesicular transport system already at the early stages of the disease.

Modulation of periaqueductal grey defense circuitry by locus coeruleus in context of Parkinson's disease

Alexia Lantheaume¹, Konstantin Kobel¹, Michael Schellenberger¹, Dennis Segebarth¹, Philip Tovote¹

¹Institut of Clinical Neurobiology, University Hospital Würzburg, Germany

Among the variety of symptoms characterizing Parkinson's disease (PD), freezing of gait (FoG) can become disabling for patients, yet efficient treatment options are lacking. Anxiety, a defensive state elicited upon real or perceived threat, has been linked to the severity of FoG in PD. One typical defensive behavioral pattern is freezing, whose expression is mediated by brain circuitry involving the ventrolateral periaqueductal gray (vIPAG).

Our neuroanatomical investigation shows that vIPAG receives inputs from the locus coeruleus (LC), a region particularly affected by α -synuclein-driven cell death during PD. We hypothesize that cell loss within the LC could influence the activity profile of vIPAG cells, leading to dysregulation of the defensive response. Such a lack of neuro-modulatory input could explain why anxious patients show anxiety-dependent motor dysfunctions, such as increased FoG episodes.

Ex vivo slice electrophysiological assessment revealed that vIPAG glutamatergic and GABAergic neurons, two circuit elements involved in defensive freezing are modulated by LC inputs. While vIPAG GABA neurons firing was boosted, glutamatergic neuronal activity was attenuated. In the framework of the reported vIPAG defense circuitry, both effects would result in a decrease of vIPAG excitatory outputs, which have been connected to freezing responses. These results are in line with previous research on LC influence on locomotion, where tonic LC activity counteracts freezing.

We also developed a viral approach for cell-type specific expression of A53T- α -synuclein, combined with *in vivo* optogenetics and calcium imaging techniques. This allows us to assess the impact of pathological α -synuclein aggregation within LC inputs on distinct vIPAG circuit elements and associated defensive locomotor patterns.

A better mechanistic understanding of this circuit could contribute to more precise therapeutic targeting of FoG appearance in PD patients.

Pharmacological Modulation of Serotonin Receptor 7 as a Potential Treatment for Tau-associated Neurodegenerative Diseases

Alina Brüge¹, Kathrin Jahreis¹, Sungsu Lim², Yun Kyung Kim², Marcello Leopoldo³, Evgeni Ponimaskin¹, Josephine Labus Labus¹

¹Institute for Cellular Neurophysiology, Hannover Medical School (MHH), Hannover, Germany

²Korea Institute of Science and Technology (KIST), Seoul, Republic of Korea

³Department of Pharmacy-Drug Sciences, University of Bari Aldo Moro, Bari, Italy

A distinctive feature of multiple neurodegenerative diseases is the pathological and progressive deposition of fibrillary protein aggregates located both extracellularly and intracellularly of neurons. One of the most prominent proteins in this context is the microtubule-associated protein tau. Physiologically, tau is crucial for microtubule assembly and stabilization. However, under pathological conditions, it is involved in the development of numerous neurodegenerative diseases collectively termed tauopathies. These include Alzheimer's disease, Frontotemporal dementia (FTD) or Huntington's disease, all of which share the common hallmark of forming neurotoxic aggregates composed of hyperphosphorylated tau. These so-called neurofibrillary tangles are associated with neuronal loss and cognitive decline.

We have recently shown that the constitutive activity of the serotonin receptor 7 (5-HT7R) mediates pathological tau hyperphosphorylation, aggregation and neurotoxicity both *in vitro* and *in vivo* (Labus et al., Prog. Neurobiol., 2021). In the present study, we pharmacologically blocked the constitutive activity of 5-HT7R using inverse agonists and proved their therapeutic potential to ameliorate tau pathology.

We screened numerous clinically approved anti-depressive and anti-psychotic drugs for their inverse agonism towards the 5-HT7R and identified the neuroleptic drug Amisulpride as a promising candidate. Characterization of Amisulpride revealed its beneficial effects on tau hyperphosphorylation and aggregation *in vitro*. Moreover, we demonstrated that Amisulpride treatment ameliorates tau pathology and memory impairment in two different mouse models of tau-related FTD *in vivo*. To further enhance the therapeutic potential of Amisulpride and to reduce its side effects, we synthesized and validated Amisulpride derivatives that are more specific for 5-HT7R.

Taken together, our data demonstrate a novel therapeutic approach for the treatment of tauopathies by pharmacologically modulating the constitutive 5-HT7R activity with Amisulpride.

Probing astroglial dysfunction in motor cortex of behaving ALS transgenic mice

XiaoQian Ye^{1,4}, Zeynep Gunes^{1,2,4}, Sabine Liebscher^{1,2,3,4}

¹Ludwig Maximilians Universität, Institute of Clinical Neuroimmunology, Großhaderner Strasse, 9, 82152 Planegg-Martinsried, Munich, Germany

²Graduate School of Systemic Neurosciences, Ludwig Maximilians University Munich, Munich, Germany

³Graduate School of Systemic Neurosciences, Ludwig Maximilians University Munich, Munich, Germany

⁴Biomedical Center, Ludwig Maximilians University Munich, Munich, Germany

Amyotrophic lateral sclerosis (ALS) is multifactorial motor neuron disease with no cure found yet. *In vitro* evidence suggests that astrocytes contribute to the motor neuron (MN) death, indicating the contribution of non-cell autonomous processes in the degeneration of MN, but the mechanisms underlying this detrimental interaction remain incompletely understood. Despite being considered electrically silent, astrocytes display calcium transients associated with a plethora of cellular processes, such as in response to transmitter binding or release. We here used *in vivo* two-photon imaging to study astrocytic Ca²⁺ responses in motor cortex of awake behaving ALS transgenic mice, namely SOD1^{G93A} and FUS^{dNLS} mice across disease stages, to explore the notion that physiological function is compromised in cortical astrocytes, contributing to MN degeneration. We indeed observe compromised Ca²⁺ signals in response to locomotion, which are shared by the two ALS mouse models during the symptomatic stage. For FUS^{dNLS} transgenic mice, the compromised calcium signals are already present at disease onset. To address the question as to whether these changes are due to cell-autonomous alterations or a downstream effect as a result of compromised input remains open so far. We thus employ *in vivo* pharmacological stimulations to interrogate astrocytic calcium responses to the stimulation of a set of well-known receptor agonists. Our preliminary results indicate mixed effect arguing for both cell-autonomous and network-based effects due to compromised input. To further identify cell-autonomous molecular alterations of cortical astrocytes in ALS, we performed a region-specific and astrocyte-selective proteomics analysis in the SOD1^{G93A} mouse model. Our data reveals a clear proteomic signature specific to astrocytes in motor cortex, consisting mainly of downregulated proteins, which is not present in visual cortex, a non-affected brain area. We also found overlapping differentially expressed proteins with published ALS iPSC-astrocytes and transcriptionally altered genes found in spinal cord in late stage SOD1^{G93A} mice obtained through single cell RNA-sequencing. One candidate Tmem259, which regulates EAAT2 expression, is downregulated in motor cortex and spinal cord in these mice. Further investigation will identify and verify additional molecular candidates and their role for astrocytic calcium signaling and neuronal health.

Role of Bassoon in the regulation of presynaptic proteostasis

Carolina Montenegro Venegas^{1,2,3}, Anil Annamneedi^{1,3,4}, Armand Blondiaux¹, Judit Ozvár^{6,7}, Yi Lien^{6,7}, Thorsten Trimbuch^{6,7}, Christian Rosenmund^{6,7}, Craig Craig Curtis Garner^{5,6,7}, Eckart D Gundelfinger^{1,2,3}

¹Leibniz Institute for Neurobiology, Department of Neurochemistry and Molecular Biology, Magdeburg, Germany, ²Institute for Pharmacology and Toxicology, Otto von Guericke University Magdeburg, Germany, ³Center for Behavioral Brain Sciences, (CBBS), Magdeburg, Germany, ⁴Institute of Biology (IBIO), Otto von Guericke University, Magdeburg, Germany, ⁵German Center for Neurodegenerative Diseases (DZNE), Berlin Germany, ⁶Charité-Universitätmedizin Berlin, ⁷Institute of Neurobiology, Berlin, Germany, ⁷NeuroCure Cluster of Excellence, Charité-Universitätmedizin Berlin, Berlin, Germany

Synapses are critical for brain function. Dysfunctions of these interneuronal connections, i.e., defects in neuronal transmission and plasticity, and in turn, memory impairments and loss of synapses, are the major cause of so-called synaptopathies, including neurodegenerative diseases and age-related disorders. Many of these disorders, including Alzheimer's or Parkinson's disease, are associated with impaired proteostasis, including disturbances of the ubiquitin-proteasome system (UPS) or the autophagy pathway, a lysosome-dependent route for degradation of cytosolic material in eukaryotic cells. Recently, it was shown that in glutamatergic synapses, ubiquitination is important for the generation of autophagic structures and that synaptic vesicle proteins can enter the autophagy pathway after being damaged by reactive oxygen species, but how exactly are presynaptic proteins tagged for degradation and how entry into degradative pathways is controlled in GABAergic and dopaminergic boutons, are not well understood.

Bassoon (Bsn), a presynaptic scaffolding protein important for the structural and functional organization of the neurotransmitter release site, was found to interact and suppress the activity of Atg5, an essential component of phagophore formation, and thereby controls presynaptic autophagy. Moreover, increased levels of presynaptic autophagy in the absence of Bassoon require ubiquitination of synaptic vesicle proteins through the activation of the E3 ligase Parkin and Siah1.

Here, we explore the role of Bsn in regulating presynaptic autophagy at dopaminergic and GABAergic boutons. To study this, we co-transduce the autophagy marker RFP-LC3 into primary hippocampal and dopaminergic neurons derived from conditional knockout mice lacking Bsn only in GABAergic interneurons or dopaminergic neurons. The loss of Bsn leads to elevated number of RFP-LC3 puncta per axon unit length. Interestingly, data from proteomic analyzes of hippocampal samples from Bsn knockout mice showed changed in the expression levels of E3 ubiquitin ligases and ubiquitin carboxyl-terminal hydrolase, which play important roles in the regulation of proteasomal and lysosomal degradation.

Taken together, our results will help us to define the local regulators of presynaptic proteostasis for the clearance of specific cargos. Future studies on the links between proteostasis pathways and Bsn will also help to better understand age-related and neurodegenerative disorders of the brain.

Funded by the DFG (FOR5228), CBBS promoted by Europäische Fonds für regionale Entwicklung—EFRE (ZS/2016/04/78113)

Okerlund et al., (2017) *Neuron* 97 (4): 897-913 PMID: 28231469

Hoffmann et al., (2019) *J Neurosci.* 39 (12):2163-2183 PMID: 30655355

Hoffmann-Conaway et al., (2020) *Elife* 9:e56590. PMID: 32364493

Montenegro-Venegas et al., (2021) *Cell Mol Life Sci.* 78 (4)1545-1563. PMID: 32651614

Serotonin receptors contribute to TDP-43 aggregation in neurodegenerative diseases

Josephine Labus¹, Anna-Lena Vollbrecht¹, Julia Kleinert¹, Tilman Tiss¹, Sungsu Lim², Yun Kyung Kim², Thomas Gschwendtberger³, Susanne Petri³, Evgeni Ponimaskin¹

¹Cellular Neurophysiology, Hannover Medical School, Hannover, Germany

²Brain Science Institute, Korea Institute of Science and Technology, Seoul, Republic of Korea

³Department of Neurology, Hannover Medical School, Hannover, Germany

The RNA/DNA-binding protein TDP-43 is important for normal brain development as it critically regulates RNA metabolism including transcription, splicing and translation of mRNA in the nucleus. Remarkably, cytoplasmic inclusions of TDP-43 are found in the brain and spinal cord of patients with a variety of neurodegenerative diseases. Among others, TDP-43 pathology is prevalent in amyotrophic lateral sclerosis (ALS) and frontotemporal lobar degeneration and also occurs in diseases with other primary pathologies such as Alzheimer's and Parkinson's disease.

Besides TDP-43 pathology, dysfunctions in the serotonergic system are characteristic for neurodegenerative diseases. The neurotransmitter serotonin regulates a wide range of physiological processes, such as mood, appetite, cognition and sleep, by activating a large family of serotonin receptors. Although changes in serotonin levels and altered expression of defined serotonin receptors were observed in patients with neurodegenerative diseases, the exact role of the serotonergic system in pathological TDP-43 aggregation remains elusive.

Here, we investigated the influence of serotonin receptors on pathological TDP-43 aggregation. Using the HEK TDP-43 BiFC reporter cell line, we found that expression of different serotonin receptors induce TDP-43 aggregation. In particular, the serotonin receptor 7 (5-HT7R) increased TDP-43 aggregation and its mislocalization into the cytoplasm. Furthermore, the presence of 5-HT7R facilitates secretion and spreading of TDP-43 aggregates, which is crucial for the progression of TDP-43-related neurodegeneration. We also investigated the underlying cellular mechanisms. Finally, using human iPSC-derived motor neurons from ALS patients, we validated 5-HT7R as a novel target in the treatment of TDP-43-related disorders.

Synaptic transmission defects at an early stage in juvenile Battens disease mouse model

Masood Ahmad Wani¹, Benedikt Grünewald¹, Jakob von Engelhardt¹

¹Johannes Gutenberg University of Mainz, Institute of Pathophysiology, Duesbergweg 6, 55128 Mainz, Germany

Loss of function mutations in *CLN3* gene causes neuronal dysfunction and subsequently neurodegeneration in juvenile Battens disease. However, the mechanisms underlying the observed neuronal deficits remain largely unknown. As neuronal output is determined by their intrinsic excitability and synaptic inputs, we investigated intrinsic membrane properties and synaptic transmission in 5-month-old *Cln3*^{Δex7/8} mice. We observed subtle changes in active membrane properties, notably, a reduced firing rate of dentate gyrus granule cells in *Cln3* KO mice compared to wild-type mice. Analysis of excitatory postsynaptic currents revealed reduced mEPSC frequency and amplitude in KO granule cells. In line with this, we found significantly reduced AMPA-NMDA ratio in KOs indicating possible increase in silent synapses. Readily releasable pool (RRP) size and synaptic vesicle replenishment rate were not significantly altered, however, vesicle release probability in KOs showed a subtle reduction. Taken together, our study provides indications of early intrinsic and synaptic deficits at a disease stage when storage burden and cell death is minimal.

The pallidal inhibitory tone on ventrolateral thalamic neurons in dystonic dt^{SZ} mutant hamster after long-term deep brain stimulation

Denise Franz¹, Marco Heerddegen¹, Fabiana Santana Kragelund¹, Anika Lüttig², Angelika Richter², Rüdiger Köhling¹

¹Oscar Langendorff Institut für Physiologie, Universitätsmedizin Rostock, Gertrudenstr. 9, 18057 Rostock, Germany

²Institut für Pharmakologie, Pharmazie und Toxikologie, VMF, Universität Leipzig, An den Tierkliniken 15, 04103 Leipzig, Germany

Deep brain stimulation (DBS) of the globus pallidus internus (GPi) is an effective treatment of generalized or cervical dystonia, which improves dystonia severity by up to 60 %. Despite the rising data sets from clinical trials, however, it remains hard to predict the outcome of DBS for individual dystonic patients due to a lack of knowledge about the pathophysiology of dystonia and the mechanisms of the DBS. Both the basal ganglia and cerebellum are involved in the complex cognitive and proprioceptive movement control and send their output via the thalamus to the motor cortex. A diminished pallidal inhibition of the thalamus may lead to hyperkinetic dystonic movements. In a previous study, we demonstrate a significant reduction in the severity score after pallidal DBS with 130 Hz. To investigate if the DBS affects pallidal activity directly, we examined the inhibitory tone of pallidal projections to the ventrolateral thalamic nucleus.

In this study, we utilized the software defined implantable modular platform (STELLA) for continuously long-term pallidal DBS (130 Hz, 50 μ A) over 11 days in the freely moving animal model of the dt^{SZ} mutant hamster. The dt^{SZ} mutant hamster represents the motor phenotype of paroxysmal generalized dystonia. In a stereotactic surgery under deep isoflurane anaesthesia, we implanted bipolar electrodes bilaterally to the entopeduncular nucleus (homolog to the GPi in humans) and the STELLA to the flank of the hamsters. We differentiate between the stim group, with activation of DBS 3-4 days after surgery, and the sham group, where the DBS remained turned off over the total period. For whole-cell recordings on thalamic neurons, acute parahorizontal (appr. 30° off-horizontal) brain slices were prepared directly after the DBS was turned off or after the appropriate period for the sham group.

We first create an electrophysiological profile of the thalamic neurons by measuring membrane resistance, membrane potential, membrane capacity, the behaviour of spontaneous and induced action potentials, and characteristics of voltage-gated ion channels (HCN, KCNQ, Na_v). The inhibitory synaptic currents were detected after applying the glutamatergic antagonists D-AP5 (50 μ M) and CNQX (10 μ M) near the thalamic neuron through a manifold. Finally, the results were verified by applying the GABAA receptor antagonist gabazine (5 μ M).

In contrast to the sham group, our results demonstrate a significantly reduced cumulative probability of spontaneous inhibitory post-synaptic potentials in thalamic neurons after long-term pallidal DBS. Comparing the amplitude, frequency, and cumulative probability of the synaptic transmission between the stim and the sham group allows for an inference of the affected area by DBS, which may optimize the prediction of the DBS outcome.

This study is supported by the German Research Foundation (DFG) within the Collaborative Research Centre (SFB 1270/1,2 ELAINE 299150580). We also thank Tina Sellmann for the support at the surgeries and Joe Ziminski from Easy Electrophysiology for the opportunity to use their analysis software.

The use of human gastrointestinal organoids to study interactions with the nerve system and the induction of neuroinflammation by pathogens including *Helicobacter pylori*

Marzieh Ehsani¹, Zeyang Sun¹, Huo Peng¹, David Holthaus¹, Saskia F. Erttmann^{1,2},
Thomas F. Meyer^{1,3}

¹Laboratory of Infection Oncology, Institute of Clinical Molecular Biology (IKMB), University Hospital Schleswig-Holstein, Kiel, Germany

²Department of Molecular Biology, Umeå Centre for Microbial Research (UCMR), Umeå University, Umeå, Sweden

³Department of Molecular Biology, Max Planck Institute for Infection Biology, Berlin, Germany

One of the hallmarks of *Helicobacter pylori* (Hpy) infections is the overwhelming inflammation of the infected gastric mucosa. The vagus nerve connects the gastric mucosa with the brain at sites where neurodegeneration is thought to be initiated. In fact, Parkinson's disease (PD) has been associated with gastrointestinal dysfunction, and it has been reported that infection with Hpy, the key pathogen of the human stomach, is more common among PD patients compared to healthy subjects. Moreover, several human clinical trials have shown that the eradication of Hpy using antibiotics significantly improves the health condition in PD patients.

Thus, we are investigating the link between Hpy-induced inflammation of the gastric tissue and the initiation and progression of neuroinflammatory diseases. Besides common cell lines, we will use human primary gastric cell culture systems to study the interaction of differentiated neuroendocrine cells with the endings of neurons from the vagus nerve. Investigating the interaction and function of gastrointestinal synapses with nerve cells will be crucial for our understanding of the transmission of gastrointestinal signals towards the brain and their impact on the development of neurodegenerative diseases.

Initial observations provided tantalizing evidence for the occurrence of PD-specific modifications of host cell proteins in Hpy infected cells.

Time lapse imaging of single granule cells in the mouse dentate gyrus after entorhinal denervation in vitro – identification of different response types to denervation

Davide Greco¹, Alexander Drakew¹, Thomas Deller¹

¹Clinical Neuroanatomy, Dr. Senckenbergische Anatomie, Heinrich-Hoffmann-Strasse 7, 60528 Frankfurt am Main, Germany

The reorganization of synaptic connections is an important mechanism contributing to the recovery of neuronal networks following brain injury. In recent years, we established an in vitro denervation model using organotypic slice cultures to visualize structural changes of dentate granule cells (GC) following entorhinal denervation. Here we used this model to analyze spine density changes of denervated and non-denervated dendritic segments of single GCs. AAV-injections were employed to transduce dentate granule cells with tdTomato and entorhinal projection neurons with GFP. This allowed us to visualize both innervating entorhinal fibers and their target neurons. Furthermore, we could readily distinguish segments innervated by entorhinal fibers (in the outer molecular layer) from those receiving other afferents (in the inner molecular layer). Entorhinal lesion was performed at 18-19 DIV and time-lapse confocal imaging was used to visualize single dendritic segments of the same neuron. Non-denervated cultures imaged at the same time points served as controls. As previously reported, average dendritic spine loss was 30-40% of all spines (2-4 days post lesion) in the denervated zone, whereas average spine density remained constant in the non-denervated layer. Individual neurons showed a broad variability in their reaction to denervation in both layers. Different types of layer-specific spine density changes and spine dynamics were identified and distinguished. Furthermore, our data suggest that more extensive sampling strategies, i.e. sampling of several segments of one neuron, may result in more robust results than the sampling of single dendritic segments, since dendritic segments of a neuron may differ considerably in their response to denervation (supported by DFG).

Two-photon imaging identifies blood-brain barrier alterations in a murine Alzheimer's disease model

Amira S. Hanafy^{1,2}, Isabelle Paulußen¹, Alf Lamprecht², Dirk Dietrich¹

¹Department of Neurosurgery, University Hospital Bonn, Bonn, Germany

²Department of Pharmaceutics, Institute of Pharmacy, University of Bonn, Bonn, Germany

The literature identifies three hypotheses involving the blood-brain barrier (BBB) to explain Alzheimer's disease (AD): disrupted tight junctions (TJ), decreased functionality of efflux transporters and increased activity of receptor for advanced glycation end products (RAGE).

In this study, we used a newly established *in situ* BBB model to investigate these hypotheses in transgenic Tg2576 AD mice. In our model, a controlled micropipette-based local perfusion of capillaries is performed in acute brain slices, while simultaneously monitoring the cellular trafficking of perfused dyes using high resolution real-time two-photon (2P) microscopy. Acute cortical brain slices were obtained from age-matched wildtype and transgenic Tg2576 mice, and placed in a submerged chamber of a 2P microscope. A carefully selected blood vessel was pierced with a dye-filled pipette and the dye was ejected under controlled pressure. The integrity of TJ was assessed via quantifying the extravascular leakage and membrane diffusion of test dyes. Moreover, 3D reconstructed focused ion-beam scanning electron microscopy (FIB-SEM) was employed to investigate the structure of TJ. The functionalities of two ATP-binding cassette (ABC) transporters, ABCB1 and ABCC1, and RAGE receptor were evaluated as well.

Compared to wildtype mice, the diffusion of tetramethylrhodamine in the parenchyma was doubled in Tg2576 capillaries, while the membrane diffusion of FM1-43 probe from the luminal to abluminal side of endothelial cells was 2.3-fold higher (Fig. 1a). FIB-SEM analysis revealed scarcer and shorter TJ in Tg2576 capillaries. Based on the accumulation of calcein dye within the endothelial cells under sole or combined inhibition of ABCB1 and ABCC1 transporters, their efflux activity in Tg2576 capillaries decreased by 30% and 85%, respectively (Fig. 1b). Surprisingly, the uptake of β -amyloid from blood to brain was 60% lower in Tg2576 capillaries compared to wildtype mice, regardless of RAGE inhibition by FPS-ZM1 (Fig. 1c).

The obtained results may imply the disruption of TJ due to a possible partial disassembly of the transmembrane domains of junctional proteins. The reduced efflux activity of ABCB1 and ABCC1 transporters could account for the poor calcein clearance from AD capillaries. However, as opposed to the often-reported data, RAGE receptor is not overly activated in Tg2576 capillaries.

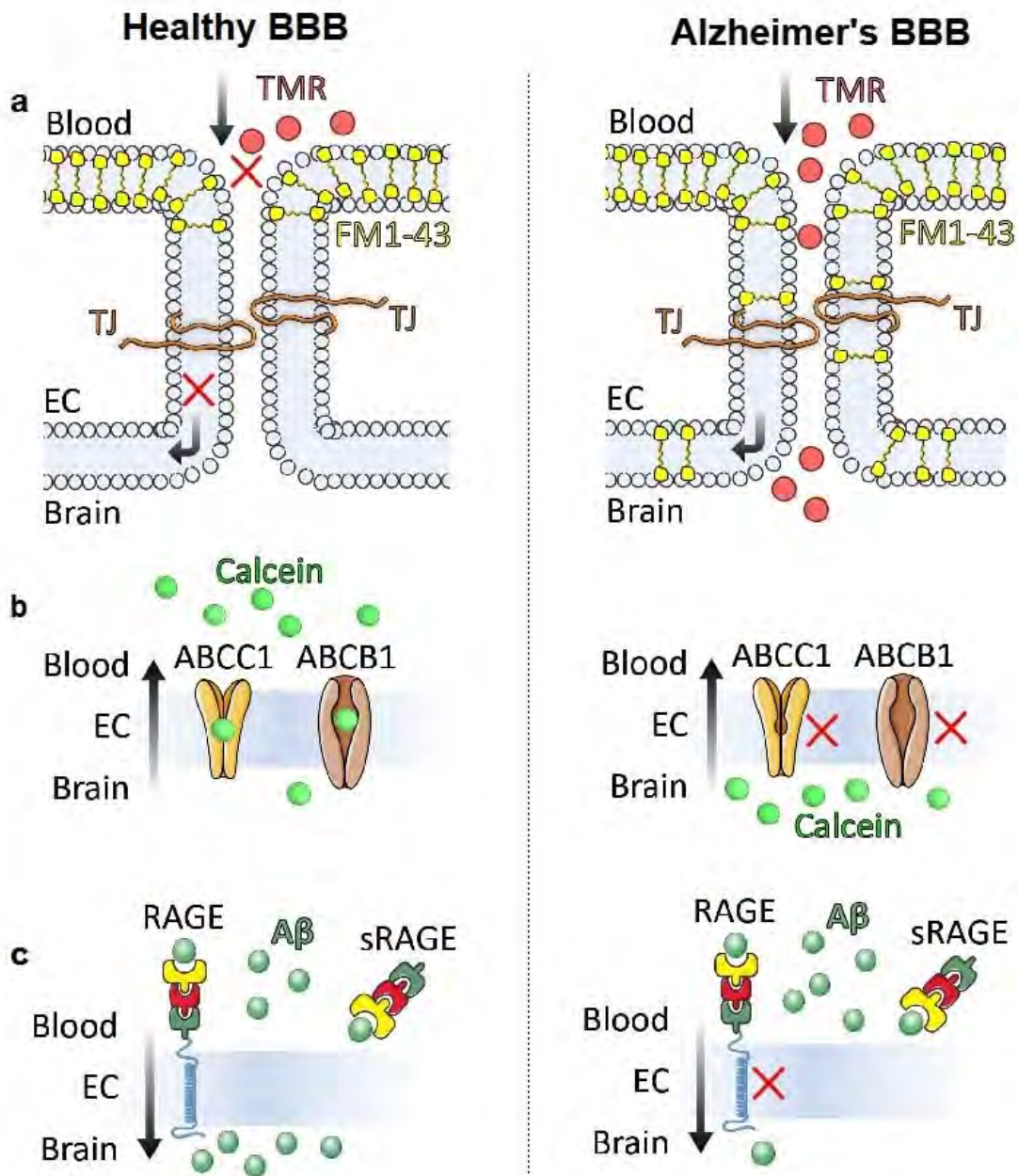

Fig. 1: Schematic representation of the identified pathological blood-brain barrier alterations in Alzheimer's Tg2576 mouse brain (right) compared to healthy brains (left). a, the tight junctions are more leaky b, decreased activity of ABCB1 and ABCC1 efflux transporters. c, decreased activity of RAGE receptor.

Poster Topic

T12: Neuroimmunology, Inflammation and Neuroprotection

- [T12-1A](#) Acute effects of human monoclonal anti-GluN1 autoantibody on NMDA receptor channel function
Johanna Rosa Heckmann, Shang Yang, Jing Yu-Strzelczyk, Shiqiang Gao, Christian Geis, Manfred Heckmann
- [T12-2A](#) Anti-NMDAR autoantibodies alter structural plasticity and impair place cell dynamics
Steffan Pettengell Jones, Pavel Svelha, Sabine Liebscher
- [T12-3A](#) Astrocytes, microglia and blood brain barrier in an animal model of cerebral malaria
Hanna-Marie Altjohann, Bastian Bennühr, Alexandros Hadjilaou, Thomas Jacobs, Daniela Hirnet, Christian Lohr
- [T12-4A](#) Attenuation of microgliosis is not sufficient to achieve substantial neuroprotection during the early phase of TBI
Isa Wernersbach, Yong Wang, Michael K. E. Schäfer
- [T12-5A](#) Establishing induced pluripotent stem cells (iPSCs)-derived sensory neurons from migraine patients to investigate sex-specific differences in TRESK-TRPV1 signaling
Beatrice A. Windmüller, Oliver Dräger, Wilfried Witte, Erhard Wischmeyer
- T12-6A Retracted
- [T12-7A](#) Hypoxic Microglial Extracellular Vesicles Can Abrogate AQP4 Dysfunction, Astrogliosis, and Neuroinflammation After Stroke
Wenqiang Xin, Yongli Pan, Wei Wei, Lars Tatenhorst, Irina Graf, Mathias Bähr, Thorsten R. Doeppner
- [T12-8A](#) Increased neuronal resistance to excitotoxic insults due to the AMPA receptor auxiliary subunit CKAMP44
Benedikt Grünewald, Matthias Venyi, Jonas Schroer, Masood Ahmad Wani, Anne Sinning, Heiko Luhmann, Jakob von Engelhardt
- [T12-9A](#) Investigating adaptive response mechanisms in autoimmune encephalitis with autoantibodies to the AMPA receptor
Tanvi Bhagwat, Holger Haselmann, Michael Kessels, Britta Qualmann, Christian Geis
- [T12-10A](#) Knockdown of NEAT1 prevents lipid droplet accumulation in primary microglia after ischemic stroke via autophagy pathway

Yongli Pan, Wenqiang Xin, Wei Wei, Lars Tatenhorst, Irina Graf, Mathias Bähr, Thorsten R Doepfner

- [T12-1B](#) Mechanistic single-cell investigation of neuroinflammation induced by influenza A virus infection
Lea Gabele, Shirin Hosseini, Kristin Michaelsen-Preusse, Nele Rieke, Christian Sieben, Martin Korte
- [T12-2B](#) IAV replication kinetics and cell tropism in mouse primary hippocampal cultures
Nele Rieke, Lea Gabele, Shirin Hosseini, Martin Korte, Christian Sieben
- [T12-3B](#) Microglia mediate neurocognitive deficits by eliminating C1q tagged synapses in sepsis-associated encephalopathy
Jonathan Wickel, Ha-Yeun Chung, Nina Hahn, Nils Mein, Meike Schwarzbrunn, Philipp Koch, Mihai Ceanga, Holger Haselmann, Carolin Baade-Büttner, Nikolai von Stackelberg, Nina Hempel, Lars Schmidl, Marco Groth, Nico Andreas, Juliane Götze, Sina M. Coldewey, Michael Bauer, Christian Mawrin, Justina Dargvainiene, Frank Leyboldt, Stephan Steinke, Zhao-Qi Wang, Michael Hust, Christian Geis
- [T12-4B](#) Network pharmacology as a novel strategy for treating acute brain ischemia
Sebastian Erik Vonhof, Rebecca Steubing, Sepideh Sadegh, Jan Baumbach, Svenja Christina Rohde, Anna Hamker, Harald Schmidt, Christoph Kleinschnitz, Ana Isabel Casas
- [T12-5B](#) Neuroprotection in human cells: Functions of an evolutionary ancient cytokine receptor
Debra Yasemin Knorr, Ignacio Rodriguez Polo, Hanna Sopia Pies, Nicola Schwedhel-Domeyer, Stephanie Pauls, Rüdiger Behr, Ralf Heinrich
- [T12-6B](#) New insights in neuropathology and pathogenesis of autoimmune glial fibrillary acidic protein meningo-encephalomyelitis
Verena Endmayr, Frank Leyboldt, Katharina Hess, Christoph Röcken, Desiree De Simoni, Stefan Oberndorfer, Ellen Gelpi, Simon Robinson, Chad Guthrie, Simon Hametner, Romana Hoeffberger
- [T12-7B](#) Novel targets of glycine receptor autoantibodies in stiff person syndrome
Anna-Lena Eckes, Inken Piro, Erdem Tüzün, Christian Werner, Claudia Sommer, Carmen Villmann
- [T12-8B](#) Pathology of CASPR2 autoantibodies – investigation of protein expression level and protein-protein interactions within the VGKC
Patrik Greguletz, Maria Plötz, Michele Niesner, Carmen Villmann, Kathrin Doppler
- [T12-9B](#) Poststroke lipid droplet accumulation in residing microglia and its influence on inflammation and phagocytosis
Wei Wei, Dirk Fitzner, Wenqiang Xin, Yongli Pan, Irina Graf, Lars Tatenhorst, Mathias Bähr, Thorsten R Doepfner
- [T12-10B](#) Serum anti-AGO1 antibodies identify a patient subgroup of sensory neuropathy responding better to immunomodulatory treatment

Christian Moritz, Yannick Tholance, Pierre-Baptiste Vallayer, Le-Duy Do, Sergio Muñoz-Castrillo, Véronique Rogemond, Karine Ferraud, Coralie La Marca, Jérôme Honnorat, Martin Killian, Stéphane Paul, Jean-Philippe Camdessanché, Jean-Christophe Antoine

- [T12-1C](#) Pre-traumatic antibiotic-induced depletion of the gut microbiome reduces neuroinflammatory response in acute murine traumatic brain injury
Katharina Ritter, Diana Vetter, Michael KE Schaefer
- [T12-2C](#) Role of BDNF/TrkB and pro-BDNF/p75^{NTR} signaling in modulating the microglia functional state in the aging brain
Yesheng Sun, Marta Zagrebelsky, Martin Korte
- [T12-4C](#) Spatial transcriptomics identifies local and cell type-specific pathophysiological changes in a mouse model of sepsis-associated encephalopathy
Nina Hahn, Martin Bens, Marco Groth, Christian Geis
- [T12-5C](#) Synaptic network dysfunction and increased intrinsic neuronal excitability in GluA2 autoimmune encephalitis
Yang Yuan, Christian Geis, Holger Haselmann
- [T12-6C](#) Tauroursodeoxycholic acid as a treatment of spinal cord injury
Jörg Mey, Lorenzo Romero-Ramírez, Concepción García-Rama, Siyu Wu, Boris W. Kramer
- [T12-7C](#) The astrocytic-microglial crosstalk leads to a HIF-1 α -nitric oxide positive feedback loop during hypothalamic inflammation
Francesco Arioli, Olaf Jöhren
- [T12-8C](#) The potential therapeutic role of itaconate and mesaconate on the detrimental effects of neuroinflammatory processes in the brain
Melanie Ohm, Shirin Hosseini, Karsten Hiller, Martin Korte
- [T12-9C](#) The role of polyinosinic:polycytidylic acid (Poly I:C) as a viral mimetic on glutamate clearance by astrocytes and microglia
Xizi Shi, Shirin Hosseini, Kristin Michaelsen-Preusse, Martin Korte

Acute effects of human monoclonal anti-GluN1 autoantibody on NMDA receptor channel function

Johanna Rosa Heckmann^{1,2}, Shang Yang^{2,3}, Jing Yu-Strzelczyk², Shiqiang Gao²,
Christian Geis¹, Manfred Heckmann²

¹Jena University Hospital, Department of Neurology, Am Klinikum 1, 07747 Jena, Germany

²University of Würzburg, Institute of Physiology, Röntgenring 9, 97070 Würzburg, Germany

³Janelia Research Campus, Howard Hughes Medical Institute, Ashburn, United States

Autoantibodies against ionotropic N-methyl-D-aspartate (NMDA) receptors from patients with autoimmune encephalitis are pathogenic and induce typical disease signs upon passive-transfer [1-3, reviewed in 4]. Long-term antibody effects on target antigen internalization have been described for NMDA receptors [3, 4]. However, direct and acute effects of specific human autoantibodies on NMDA receptor channel function remained unexplored. We used cell-attached single channel recording with high (1 mM glutamate, 0.1 mM glycine) and low (4 μ M glutamate, 1 μ M glycine) agonist concentrations on transiently transfected HEK cells to investigate direct effects of a specific monoclonal human autoantibody (IgG 003-102) and its fab-fragments against the amino-terminal domain (ATD) of the GluN1 subunit [3, 5] (see Figure Representative recordings for low agonist concentration). Recordings were performed and evaluated in a blinded fashion. We find that IgG 003-102 reduces the number of simultaneously open NMDA receptor channels significantly at low and high agonist concentrations, whereas the fab-fragments of IgG 003-102 do not have an effect. Our findings suggest that both antigen binding sites of IgG 003-102 need to bind to the NMDA receptor to cause the observed blocking effect. Further investigations will be done to better understand this effect.

1 Dalmau J, Tüzün E, Wu HY, Masjuan J, Rossi JE, Voloschin A, Baehring JM, Shimazaki H, Koide R, King D, Mason W, Sansing LH, Dichter MA, Rosenfeld MR, Lynch DR (2007) Paraneoplastic anti-N-methyl-D-aspartate receptor encephalitis associated with ovarian teratoma. *Ann Neurol* 61:25-36

2 Dalmau J, Lancaster E, Martinez-Hernandez E, Rosenfeld MR, Balice-Gordon R (2011) Clinical experience and laboratory investigations in patients with anti-NMDAR encephalitis. *Lancet Neurol* 10:63-74

3 Kreye J, Wenke NK, Chayka M, Leubner J, Murugan R, Maier N, Jurek B, Ly LT, Brandl D, Rost BR, Stumpf A, Schulz P, Radbruch H, Hauser AE, Pache F, Meisel A, Harms L, Paul F, Dirnagl U, Garner C, Schmitz D, Wardemann H, Prüss H (2016) Human cerebrospinal fluid monoclonal N-methyl-D-aspartate receptor autoantibodies are sufficient for encephalitis pathogenesis. *Brain* 139:2641-2652

4 Dalmau J, Geis C, Graus F (2017) Autoantibodies to Synaptic Receptors and Neuronal Cell Surface Proteins in Autoimmune Diseases of the Central Nervous System. *Physiol Rev.* 97:839-887

5 Jalali-Yazdi F, Chowdhury S, Yoshioka C, Gouaux E (2018) Mechanisms for Zinc and Proton Inhibition of the GluN1/GluN2A NMDA Receptor. *Cell* 175:1520-1532

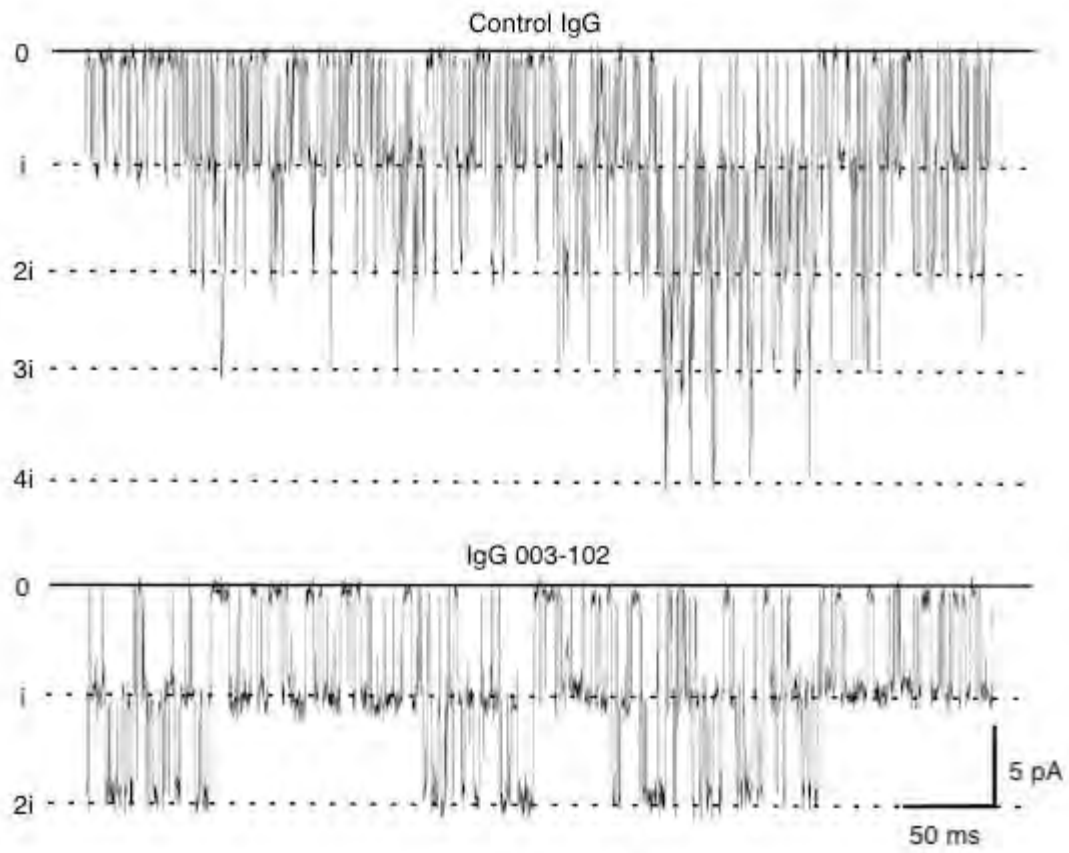

Representative recordings for low agonist concentration

Anti-NMDAR autoantibodies alter structural plasticity and impair place cell dynamics

Steffan Pettengell Jones¹, Pavel Svelha¹, Sabine Liebscher¹

¹Institute of Clinical Neuroimmunology, LMU Klinikum, AG Liebscher, Biomedizinisches Centrum, Großhaderner Strasse 9, 82152 München, Germany

Anti-NMDA receptor autoimmune encephalitis (NMDAR AE) is a severe neuroimmunological disease, manifesting primarily in women and resulting in a wide range of neuropsychiatric symptoms, such as hallucinations, memory and cognitive deficits, paranoia, and insomnia. These symptoms result from autoantibodies generated against subunits of the NMDA receptor (NMDAR), an ionotropic glutamate receptor that plays a crucial role in synaptic plasticity and memory in the central nervous system.

Despite progress in our understanding of autoantibody generation and how antibodies influence NMDA receptors at the single receptor and synapse level, the underlying neural circuit mechanisms governing neuropsychiatric and cognitive symptoms remain elusive. In this study, we employed chronic intracerebroventricular infusion of patient derived recombinant anti-NMDAR antibodies to explore how hippocampal neuronal function and structural plasticity are altered by infusion of anti-NMDAR antibodies using a combination of ex vivo and in vivo microscopy. These data reveal that anti-NMDAR antibodies decrease the density of dendritic spines in CA1 interneurons whilst pyramidal cell spine density is unaltered. Dendritic spine morphology was also differentially affected, with pyramidal cell spines lengthening and interneuron spines shortening. Longitudinal in vivo two-photon imaging revealed an increased turnover rate indicating dendritic spine instability of pyramidal neurons. The functional properties and the stability of hippocampal pyramidal cells were assessed throughout the anti-NMDAR antibody infusion using head-fixed mice navigating in virtual reality. The presence of anti-NMDAR antibodies limited the number of place fields per cell and surprisingly increased the stability of place cells across time, despite the fraction of pyramidal cells exhibiting place fields remaining stable between groups and across time. This increased stability is mirrored by an increase in the stability of CA1 pyramidal cell ensembles across time following antibody infusion.

These results indicate that chronic exposure to anti-NMDAR antibodies influences structural plasticity in both pyramidal cells and interneurons and affects hippocampal place cell formation and turnover. Further exploration of the differential effects of loss of NMDAR-mediated transmission on pyramidal cells versus interneurons can help reveal how altered patterns of activity emerge in NMDAR AE.

Astrocytes, microglia and blood brain barrier in an animal model of cerebral malaria

Hanna-Marie Altjohann¹, Bastian Bennühr¹, Alexandros Hadjilaou², Thomas Jacobs², Daniela Hirnet¹, Christian Lohr¹

¹Division of Neurophysiology, University of Hamburg, Hamburg, Germany

²Research Group Protozoa Immunology, Bernhard Nocht Institute for Tropical Medicine, Hamburg, Germany

Malaria is one of the most influential tropical diseases in human history. In the last 20 years, the WHO recorded 10.6 million deaths and especially for children the infection often has lethal consequences. The protozoan *P. falciparum*, transmitted by the *Anopheles* mosquito, is the most widespread in Africa and causes the most dangerous course of malaria among the five *Plasmodium* species that infect humans. One of severe progressions of the disease is cerebral malaria, which is accompanied by symptoms such as seizures, cognitive impairment, and coma, which mostly affects children. The reason for the development of this complication is the erythrocytes infected by the parasite, which bind to the endothelial cells in the blood vessels of the brain due to an altered surface structure, resulting in blockage of the vessels. In addition, when the parasite has sufficiently multiplied internally, the red blood cells burst and release malaria toxins, which cause neuroinflammation and fever, typical of the disease.

A frequently used experimental disease model for cerebral malaria is the ANKA mouse model, which uses the *Plasmodium berghei* ANKA strain and shows similar pathological and symptomatic courses to human cerebral malaria. Using this model, several stages of pathogenesis have been identified and studied. In this work, using this animal model, a histochemical study of the cells involved in the blood-brain barrier (astrocytes, pericytes), as well as the microglia, which are an important component of the neurological immune response, was performed. Neuroinflammatory processes were detected in all brain areas investigated, as well as evidence for degradation of activated astrocytes. Also, loss of pericytes and leakage of intervascular cells into surrounding tissues was observed. In particular, the olfactory bulb exhibited multiple hematomas and partial amoeboid microglia, suggesting that this brain area is among the most severely affected and subject to neuronal inflammatory responses in the setting of experimental cerebral malaria.

Furthermore, the expression of aquaporine-4 (AQP4), a water channel protein specifically found in astrocyte endfeet, was studied in multiple brain areas using histochemical methods. Also studied was the distribution of mouse IgG outside of the blood vessels to measure blood brain barrier integrity. Even though increased AQP4 expression has been associated with inflammation in human brains, no significant change in expression was measured in any of the observed brain areas in the ANKA mouse model. However, a significant change in mouse IgG concentration outside of the blood vessels was measured in all observed brain areas, suggesting deterioration of the blood brain barrier integrity throughout the mouse brain in the context of experimental cerebral malaria.

Attenuation of microgliosis is not sufficient to achieve substantial neuroprotection during the early phase of TBI

Isa Wernersbach¹, Yong Wang¹, Michael K. E. Schäfer¹

¹University Medical Center Mainz, Department of Anesthesiology, Langenbeckstraße 1, 55131 Mainz, Germany

Traumatic brain injury (TBI) is the leading cause of death and disability for people under the age of 45 with symptoms of physical, cognitive, and behavioral deficits. Pathogenic processes of TBI start at the time external force effects the brain and induces the primary injury causing immediate brain tissue destruction, blood vessel disruptions, and neural cell death. Lasting subsequent secondary injury, highly associated with neuroinflammation, can lead to short- and long-term detrimental effects. Currently no available neuroprotective agent exists that can prevent or reverse the damage caused by secondary processes following TBI.

In this study, it has been examined whether posttraumatic microglia targeting via dietary administration of the colony-stimulating factor 1 receptor (CSF1R) antagonist Pexidartinib (PLX3397) affects early TBI pathogenesis.

Methods: A total of 40 C57BL/6J mice, males and females, were investigated; 24 were subjected to the controlled cortical impact (CCI) model of TBI and 16 underwent a Sham procedure. Half of each group received chow containing 290 mg/kg PLX3397 for 5 days post-injury (dpi) starting at the day of injury. After euthanasia the lesion volume was assessed, and brain tissue was examined for (immuno-) histopathological and molecular pathological markers by gene and protein expression analyses.

Microgliosis and proinflammatory gene transcription were markedly increased at 5 days after CCI. Microgliosis and various neuroinflammatory gene markers, but not IL-1 β , were attenuated by approximately 50% after PLX3397 treatment after injury. Subsequent immunostaining showed that IL-1 β is mainly localized in reactive astrocytes both of which were not affected by PLX3397 administration. We further found evidence of reduced neuronal apoptosis using TUNEL staining and gene expression analysis after PLX3397 treatment, but the observed effects were not sufficient to attenuate the histopathological brain damage. In contrast, PLX3397 treatment impaired hematoma clearance probably due to an overall reduced number of phagocytic microglia. In summary, posttraumatic attenuation of microgliosis by 50% shows both beneficial and detrimental effects and potentially neurotoxic signaling via IL-1 β is not affected. The results suggest that controlling microgliosis is not sufficient to achieve substantial neuroprotection during the early phase of TBI.

Establishing induced pluripotent stem cells (iPSCs)-derived sensory neurons from migraine patients to investigate sex-specific differences in TRESK-TRPV1 signaling

Beatrice A. Windmüller¹, Oliver Dräger¹, Wilfried Witte², Erhard Wischmeyer¹

¹Department of Cellular Neurophysiology, Medical School OWL, Bielefeld University, Bielefeld, Germany

²Department of Anesthesiology and Intensive Care Medicine, Protestant Hospital of Bethel Foundation, Medical School OWL, Bielefeld University, Campus Bielefeld-Bethel, Bielefeld, Germany

Migraine is a very common neurovascular disorder yet its underlying mechanisms are still not fully understood. Due to its complexity, a variety of genetic backgrounds including a loss of function mutation in the TWIK-related spinal cord potassium channel (TRESK), which is a member of the two-pore-domain potassium channel family, has been linked to migraine pathophysiology. While childhood prevalence is similar in both sexes, migraine incidences increase in women with rising age affecting females three times more often than males, and significantly decreasing again in post-menopausal women. There is evidence that this disparity between men and women may be mediated by sex hormones, which were shown to affect the excitability and sensitization of trigeminal nociceptors by modulating the transient receptor potential vanilloid 1 (TRPV1) receptor. This receptor was further shown to be influenced by the knockout of TRESK, leading to the activation of TRPV1 and subsequent higher levels of calcitonin gene-related peptide (CGRP), which is a central mediator of migraine pathophysiology. Notably, TREK1 and TREK2, further two-pore-domain potassium channels, were reported to be inhibited in their function based on the migraine-associated TRESK mutation F139WfsX2. Here, the mutation-induced alternatively translated TRESK protein was shown to co-assemble with TREK1 and TREK2, leading to hyperexcitability in human trigeminal neurons. Currently, we are establishing a cohort of migraine patients-derived induced pluripotent stem cells (iPSCs) in order to investigate the interplay of TRESK, TREK1, TREK2 and TRPV1 in modulating excitability of trigeminal neurons with potential sex-specific differences in migraine pathology. Established migraine patient- and healthy control-derived iPSCs will be further used for the differentiation into trigeminal neurons serving as patient-specific migraine model. Using this model, we intend to investigate the molecular mechanisms leading to the development of migraine in relation to the interplay between sex hormones and TRESK-TRPV1 signaling.

Hypoxic Microglial Extracellular Vesicles Can Abrogate AQP4 Dysfunction, Astrogliosis, and Neuroinflammation After Stroke

Wenqiang Xin¹, Yongli Pan¹, Wei Wei¹, Lars Tatenhorst¹, Irina Graf¹, Mathias Bähr¹,
Thorsten R. Doeppner¹

¹University Medicine Göttingen, Neurology, Robert-Koch-Str.40, 37075 Göttingen, Germany

Despite many years of research, the molecular mechanisms underlying stroke remain elusive, and effective curative treatment after stroke is still missing. Reactive astrogliosis and perivascular aquaporin 4 (AQP4) depolarization appear and remain for a long time in the peri-infarct area. Recently, it was revealed that inhibiting AQP4 can promote neurological recovery by reducing brain edema and attenuate peri-infarct astrogliosis as well as AQP4 depolarization after stroke. Interestingly, the latest results of our group suggested a new way of action for EVs from oxygen-glucose-deprivation (OGD)-preconditioned microglia. The EV treatment promoted tissue regeneration and neurological recovery after stroke. However, a possible effect of EVs from hypoxic microglia on modulating reactive astrogliosis and the loss of AQP4 polarization in the peri-infarct area to promote neurological functional recovery still needs to be uncovered. Based on the known regulatory effects of microglia and the possible therapeutic effects of microglial EVs, we hypothesize that EVs may also regulate the pathogenesis of inflammation and participate in suppressing AQP4 depolarization and astrogliosis. By analyzing primary microglia under OGD conditions, we show that anti-inflammatory M2-type signature genes including IL-10 and CD 206 were significantly increased. Analysis of the AQP4 polarization showed that at 1, 3, 7, and 14 days after OGD the polarization of AQP4 was decreased, while GFAP intensity was increased. Next, EV treatment was further analyzed with regard to similar effects on the AQP4 polarization and inhibited astrogliosis in an ischemic mouse model. Analysis of the effects of EV-treatment on AQP4 expression and inflammation revealed a reduction of neuroinflammation as well as neurological function recovery. Taken together, our results demonstrate that EV treatment may be a potential novel treatment option in ischemic stroke.

Increased neuronal resistance to excitotoxic insults due to the AMPA receptor auxiliary subunit CKAMP44

Benedikt Grünewald¹, Matthias Venyi¹, Jonas Schroer², Masood Ahmad Wani¹, Anne Sinning², Heiko Luhmann², Jakob von Engelhardt¹

¹University Medical Center of the Johannes Gutenberg University Mainz, Institute of Pathophysiology, Duesbergweg 6, 55128 Mainz, Germany

²University Medical Center of the Johannes Gutenberg University Mainz, Institute of Physiology, Duesbergweg 6, 55128 Mainz, Germany

Kainate (KA) and Domoate are neurotoxic substances, which cause neurodegeneration through the activation of AMPA-type glutamate receptors. KA is widely used to model excitotoxic and neurodegenerative disease, e.g. temporal lobe epilepsy. Interestingly, the hippocampal neurons show a selective vulnerability to KA. The pyramidal cells of the CA1- and CA3-region are highly susceptible to KA-induced cell death, while the granule cells of the dentate gyrus (DG) are more resistant to excitotoxic insults. The susceptibility of different neuron types to KA induced neurodegeneration seems to be related to the surface distribution of AMPA receptor (AMPA) subtypes and the potency of KA. Auxiliary subunits, which are part of the AMPAR complexes in neurons, modulate both, potency and AMPAR distribution and they influence the KA-induced neurodegeneration. In the hippocampus the auxiliary subunit CKAMP44 is exclusively expressed in the DG granule cells. We therefore hypothesised that might modulate the KA-induced currents through AMPAR such that it has a neuroprotective effect which in turn could explain the relative resistance of DG granule cells to KA.

To test this hypothesis we first analysed the glutamate and KA evoked currents in outside-out patches from DG granule cells from wildtype mice and CKAMP44-deficient mice. Indeed, we found a relative increase of KA evoked steady-state currents in CKAMP44 knockout mice (CKAMP44 ko) while glutamate-evoked currents were reduced. Moreover, whole-cell currents evoked by ongoing bath application of KA were larger in CKAMP44 ko. This suggests that CKAMP44 reduces total KA evoked currents while it increases the total amount of surface expressed AMPAR. Encouraged by these findings we started experiments to analyse the effect of CKAMP44 on neurodegeneration both in-vitro and in-vivo. Preliminary results point to an increased neuronal cell death in the DG of CKAMP44-deficient mice.

In conclusion, our data suggest that the high expression of CKAMP44 in the dentate granule cells renders them relatively insensitive for KA excitotoxicity. This adds a new explanation to the long-standing question why DG granule cells are less vulnerable to excitotoxic insults. Moreover, our findings may have also implications for the understanding of the neurodegenerative processes, known as mesial temporal sclerosis, which occur during the development of temporal lobe epilepsy. The pattern of neuronal loss is reminiscent of that induced by KA excitotoxicity.

Investigating adaptive response mechanisms in autoimmune encephalitis with autoantibodies to the AMPA receptor

Tanvi Bhagwat^{1,2}, Holger Haselmann², Michael Kessels¹, Britta Qualmann¹, Christian Geis²

¹Institute for Biochemistry I, Friedrich Schiller University, University Hospital Jena, Nonnenplan 2, 07743, Jena, Germany

² Department of Neurology, University Hospital Jena, 07747, Jena, Germany

Scientific rationale: Autoimmune Encephalitis comprise of a group of neurological disorders that are characterised by autoantibodies against ionotropic and metabotropic neurotransmitter receptors and transsynaptic signalling molecules. α -amino-3-hydroxy-5-methyl-4-isoxazolepropionic acid receptors (AMPA receptors), that carry out majority of the fast excitatory synapses are also described to be a target for autoantibodies in patients. Patients harbour antibodies to the GluA1 and/or GluA2 subunit of the AMPA receptor in the CSF and develop characteristic limbic encephalitis with frequent seizures, severe deficits in memory function and neuropsychiatric symptoms. Known to cross-link the receptors and induce internalization, it is currently unclear how intracellular signalling and effector molecules induce these antibodies driven AMPA receptor trafficking ultimately leading to defective synaptic plasticity. Syndapin I is one such intracellular effector. The F-BAR protein syndapin I is involved in endocytosis of AMPARs and in synaptic plasticity mechanisms. Our work aims to unravel fundamental molecular candidates bringing about AMPAR internalization and deciphering synaptic plasticity changes upon autoantibody application.

Method: To identify candidate molecular effectors of autoantibody-induced AMPAR internalization, we use human purified IgG against AMPAR GluA2 subunit. Using receptor pre-labelling and subsequent autoantibody treatments, we quantify the extent of internalization of endogenous AMPARs in hippocampal neuronal cultures from wild-type and syndapin I KO mice. To identify the fate of the receptors post-internalization, we use immunofluorescence to analyse colocalization between GluA2 and endosomal, lysosomal and recycling endosome markers.

Results: We observed a reduced internalization in the syndapin I KO neurons upon autoantibody treatment and will present the time-courses and first mechanistic insights. In the staining experiments with endosomal and lysosomal markers, we observed increased colocalization of GluA2 subunit with the lysosomal marker.

Conclusion: Internalization of AMPARs by human autoantibodies involves syndapin I. Once internalized, the receptors are targeted for lysosomal degradation.

Knockdown of NEAT1 prevents lipid droplet accumulation in primary microglia after ischemic stroke via autophagy pathway

Yongli Pan¹, Wenqiang Xin¹, Wei Wei¹, Lars Tatenhorst¹, Irina Graf¹, Mathias Bähr¹,
Thorsten R Doeppner¹

¹University Medicine Göttingen, Neurology, Robert-Koch-Str.40, 37075 Göttingen, Germany

Lipid droplets, which are lipid storing organelles containing neutral lipids such as glycerolipids and cholesterol, are increasingly accepted as structural markers of inflammation. The nuclear paraspeckle assembly transcript 1 (NEAT1), a long non-coding RNA with over 200 nucleotides, exerts indispensable impact on the regulation of autophagy and lipid droplet accumulation in multiple neurological disorders. Interestingly, autophagy can modulate lipid droplet accumulation as well. We suppose that knockdown of NEAT1 prevents lipid droplet accumulation in primary microglia under stroke conditions, and that autophagy is involved in this process. RT-qPCR was employed to identify that NEAT1 was significantly increased in microglia after oxygen-glucose-deprivation and reoxygenation (OGD/R). The targeted antisense oligonucleotide (ASO NEAT1) was adopted to effectively silent NEAT1 in microglia. We observed by using immunofluorescence and western blotting, that lipid droplet formation and autophagy related proteins (LC3 and p62) were repressed. RT-qPCR confirmed this observation on lipid droplets markers (PLIN2 and TREM2) and signaling cascades related to autophagy (ATG3, ATG5, Beclin1, and STAT3). Furthermore, 3-MA and rapamycin were used to inhibit/activate autophagy, in turn, to illustrate the interaction of autophagy and lipid droplets accumulation. Rapamycin reversed the down-regulated lipid droplets accumulation and PLIN2 expression patterns induced by ASO NEAT1 upon OGD/R in microglia, whereas 3-MA had the opposite effect. Taken together, this study implies that NEAT1 knockdown may be a possible treatment against stroke by alleviating autophagy and suppressing lipid droplet accumulation.

Mechanistic single-cell investigation of neuroinflammation induced by influenza A virus infection

Lea Gabele^{1,2}, Shirin Hosseini^{1,2}, Kristin Michaelsen-Preusse², Nele Rieke³, Christian Sieben³, Martin Korte^{1,2}

¹Department of Cellular Neurobiology, Zoological Institute, TU-Braunschweig, Germany

²Helmholtz Centre for Infection Research, Neuroinflammation and Neurodegeneration Group, Braunschweig, Germany

³Helmholtz Centre for Infection Research, Nanoscale Infection Biology Group, Braunschweig, Germany

Influenza A virus (IAV) infection, in addition to pulmonary infections, can lead to cerebral manifestations ranging from mild cognitive impairment to encephalopathy, potentially increasing the risk for neurodegenerative diseases. Some IAV strains, such as avian H7N7 subtype, are neurotropic and capable of invading and infecting resident cells in the brain, whereas others are non-neurotropic. IAV-induced production of proinflammatory cytokines leads to activation of microglia, the brain-resident immune cells, thereby potentially triggering neuronal damage and dysfunction. Neurotropic IAV strains can hijack the host cellular machinery to enable their own replication, which might lead to alterations in host cell proteostasis. This might provoke a critical mass of protein aggregates, which are known to increase the risk for neurodegenerative diseases. IAV infections in females lead to a higher immune system activation compared to males, resulting in more rapid clearance of viruses while increasing the likelihood of developing immune-mediated diseases. In addition, an overactive immune system can lead to a higher severity after infections, which is observable in females after IAV infections. On contrary, the immune system activation is lower and slower in males than in females, which may lead to a higher likelihood of viral persistence and chronic diseases. Microglial characteristics such as phagocytosis rate, activity and morphology are sex-dependent. Therefore, a better understanding of IAV neurotropism and the mechanisms leading to deleterious neurological manifestations in a sex-specific manner is of great importance. Here, we performed *in vitro* experiments using primary hippocampal cultures from male and female newborn mice. This culture system consists of microglia, astrocytes and neurons and is a valuable model to study the effects of H7N7 IAV infection in detail. In this project, we aim to characterize the neuropathological mechanisms of IAV infection in detail by analyzing the changes in neuronal, astrocytic and microglial morphology after H7N7 IAV infection, as well as the phagocytosis rate, proliferation and activation status of microglia and astrocytes. Our preliminary results indicate that the phagocytosis rate of microglia increase 6 hours post infection (hpi), especially in male cultures. Moreover, three distinct microglial morphology types with sex-specific densities, including ramified, bushy, and amoeboid forms, were observed in female and male cultures following IAV infection. To further characterize the neurovirulence of H7N7 IAV, we are currently investigating synaptic stripping by analyzing neuronal spine density as well as the frequency of dendritic spine types following H7N7 IAV infection. The results of this study may pave the way for a better understanding of the mechanisms involved in the immediate and long-term neurological consequences of IAV infection in order to develop appropriate prevention strategies.

IAV replication kinetics and cell tropism in mouse primary hippocampal cultures

Nele Rieke¹, Lea Gabele², Shirin Hosseini², Martin Korte², Christian Sieben^{1,3}

¹Helmholtz Zentrum für Infektionsforschung, Nanoscale Infection Biology, Inhoffenstraße 7, 38124 Braunschweig, Germany

²Technische Universität Braunschweig, Zoologisches Institut, Zelluläre Neurobiologie

³Technische Universität Braunschweig, Institute for Genetics

Background: Influenza A virus (IAV) infections cause seasonal flu epidemics and, since 1918, have led to six global pandemics. There is evidence suggesting a correlation between IAV infections and the emergence of short- and long-term neurological impairments as well as the emergence of neurodegenerative diseases. Hosseini et al. (2018) could show that neurotropic and non-neurotropic IAV strains can cause such long-term neurological deficits. However, our understanding of IAV tropism within the CNS is incomplete. It remains unclear which parts of the devastating neurological deficits observed post IAV infection in mice are attributable to a dysregulated pro-inflammatory signature in the periphery or direct CNS invasion and – infection.

Methods: As a model system for the CNS we are taking advantage of primary neuronal co-culture systems consisting of neurons and astrocytes in the pre- and absence of microglia. In order to investigate sex-specific differences of cell susceptibility to IAV, male and female cultures are strictly separated from each other. For infection studies, we use a repertoire of different IAV strains. To analyze the infection kinetics of these strains in our advanced culture system at a single-cell level, we use a combination of confocal and super-resolution microscopy.

Aim: Our goal is to decipher mechanistic insights into the neurotropism of both neurotropic and non-neurotropic IAV strains. Particularly, we study the IAV replication kinetics and mechanisms in neurons, astrocytes and microglia. In addition, we address the question of how neuroinflammation upon CNS or lung infection is involved in the development of neurodegenerative diseases.

Results: Our results indicate a time shift in the replication cycle of IAV in neurons compared to astrocytes. Furthermore, using a dsRed and GFP Reporter H7N7 virus in a live assay, we observed higher susceptibility in female-derived cell cultures.

Conclusion: Here, we focus on the single-cell level to study the neurotropism of IAV in an advanced co-culture system to better understand neurological impairments after infections and the development of neurodegenerative diseases. Our results hint towards cell- and sex-specific differences in the course of acute IAV infection.

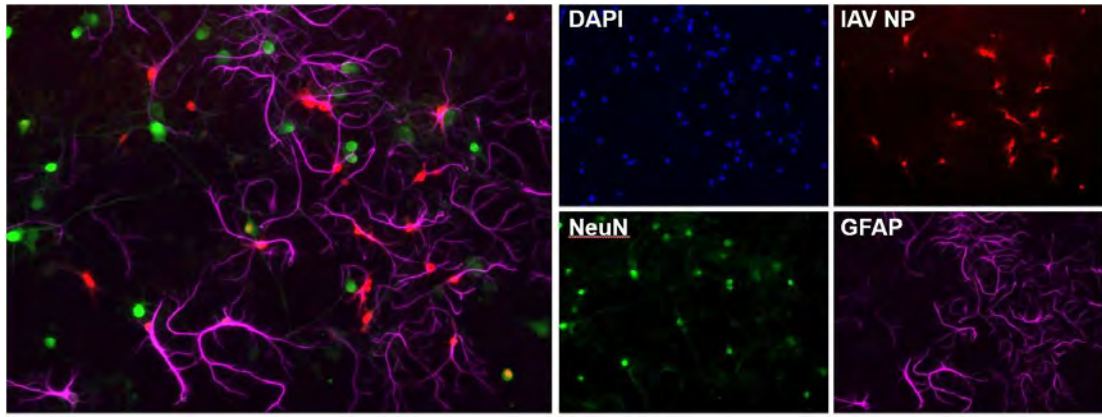

Microglia mediate neurocognitive deficits by eliminating C1q tagged synapses in sepsis-associated encephalopathy

Jonathan Wickel^{1,2}, Ha-Yeun Chung^{1,2}, Nina Hahn^{1,2}, Nils Mein¹, Meike Schwarzbrunn¹, Philipp Koch³, Mihai Ceanga¹, Holger Haselmann¹, Carolin Baade-Büttner¹, Nikolai von Stackelberg¹, Nina Hempel¹, Lars Schmidl¹, Marco Groth³, Nico Andreas⁴, Juliane Götze^{5,6}, Sina M. Coldewey^{2,5,6}, Michael Bauer^{2,5}, Christian Mawrin^{7,8}, Justina Dargvainiene⁹, Frank Leypoldt^{9,10}, Stephan Steinke¹¹, Zhao-Qi Wang^{3,12}, Michael Hust¹¹, Christian Geis^{1,2}

¹Section of Translational Neuroimmunology, Department of Neurology, University Hospital Jena, 07747 Jena, Germany

²Center for Sepsis Control and Care, University Hospital Jena, 07747 Jena, Germany

³Leibniz Institute on Aging - Fritz Lipmann Institute (FLI), 07745 Jena, Germany

⁴Institute of Immunology, University Hospital Jena, 07743 Jena, Germany

⁵Department of Anesthesiology and Intensive Care Medicine, Jena University Hospital, Jena 07747, Germany

⁶Septomics Research Center, Jena University Hospital, Jena, 07745, Germany

⁷Department of Neuropathology, University of Magdeburg, Magdeburg, Germany

⁸Section of Pathology, Institute of Forensic Medicine, Jena University Hospital, Jena, 07749, Germany

⁹Neuroimmunology, Institute of Clinical Chemistry, UKSH Kiel/Lübeck, Germany

¹⁰Department of Neurology, Christian-Albrechts-University, Kiel, 24105 Kiel, Germany

¹¹Department Medical Biotechnology, Institute for Biochemistry, Biotechnology and Bioinformatics, Technische Universität Braunschweig, Braunschweig, Germany

¹²Faculty of Biological Sciences, Friedrich-Schiller-University Jena, 07745, Germany

Sepsis-associated encephalopathy (SAE) is a severe and frequent complication of sepsis causing delirium, coma, and long-term cognitive dysfunction including deficits in general memory, attention, and executive function. Due to a decrease in mortality rates resulting from improved intensive care treatment, the number of sepsis survivors suffering from SAE is steadily growing. Yet, the pathomechanisms leading to neurocognitive deficits in SAE are largely unknown and target-specific therapeutic options are lacking. We identified microglia and C1q complement activation in hippocampal autopsy tissue of sepsis patients and in a murine peritoneal contamination and infection sepsis model. Unbiased transcriptomics of murine hippocampal tissue and isolated microglia derived from septic mice revealed an involvement of the innate immune system, complement activation, and upregulation of lysosomal pathways during SAE in parallel to neuronal and synaptic damage. We found loss of synapses and increased C1q-mediated synaptic pruning mediated by activated microglia in septic mice. Microglial engulfment of C1q tagged synapses could be prevented by stereotactic intrahippocampal injection of a specific C1q blocking antibody engineered for this study. Moreover, pharmacologically targeting microglia by PLX5622, a CSF1 receptor inhibitor, reduced C1q levels and the number of C1q tagged synapses, protected from neuronal damage and synapse loss, and improved neurocognitive outcome. Thus, we identified complement-dependent synaptic pruning by microglia as a crucial pathomechanism for the development of neuronal defects during SAE.

Our study identifies a pathogenic relevant and sustained microglia-neuron interaction during SAE. These changes induce elimination of C1q tagged synapses and eventually result in cognitive dysfunction. Microglia

manipulation or directly targeting C1q might be a promising treatment strategy for preventing long-term neurocognitive deficits in sepsis survivors.

Network pharmacology as a novel strategy for treating acute brain ischemia

Sebastian Erik Vonhof^{1,2}, Rebecca Steubing^{1,2}, Sepideh Sadegh³, Jan Baumbach³,
Svenja Christina Rohde^{1,2}, Anna Hamker^{1,2}, Harald Schmidt³, Christoph Kleinschnitz^{1,2},
Ana Isabel Casas^{1,2,3}

¹Department of Neurology, University Hospital Essen, Essen, Germany

²Center for Translational Neuro- and Behavioral Sciences (C-TNBS), Essen, Germany

³Institute of Computational Systems Biology, University of Hamburg, Hamburg, Germany

⁴Department of Pharmacology and Personalised Medicine, Faculty of Health, Medicine, and Life Sciences, Maastricht University, Maastricht, The Netherlands

Background: Brain ischemia is currently one of the highest unmet medical needs as the first leading cause of disability worldwide. Despite decades of preclinical investment there is no neuroprotective therapy available so far for clinical use. This translational roadblock could be partially attributed to a conservative treatment approach, focused on treating symptoms instead of mechanistically tackling the underlying cause of the disease.

Approach and Methods: We here propose a novel in silico-based network pharmacology approach to mechanistically target specific disease genes linked to the pathomechanism of brain ischemia. Focussing on stroke-dependent upregulated genes, we defined an in-silico target validation approach to identify the most promising therapeutic candidates. Then, by employing a multi-target multi-drug strategy we aim for a supra-additive synergistic effect while also maximally reducing dosing and potential treatment-associated side-effects.

Key Results: Stroke mice were subjected to 30 minutes of transient middle cerebral artery occlusion and subsequently underwent treatment during the subacute stroke phase, i.e., 3- and 7-days post-stroke. Compared to the control group, infarct volume, neuronal apoptosis, microglia activation and astrogliosis were significantly reduced upon treatment. Moreover, treatment resulted in direct improvements to blood-brain barrier integrity and neuro-motor functioning.

Conclusion: A multi-target signaling module identification followed by a multi-drug network pharmacology therapeutic approach allows for highly synergistic neuroprotection and an improved outcome within the subacute stroke phase.

Neuroprotection in human cells: Functions of an evolutionary ancient cytokine receptor

Debra Yasemin Knorr¹, Ignacio Rodriguez Polo², Hanna Sopia Pies¹, Nicola Schwedhel-Domeyer¹, Stephanie Pauls¹, Rüdiger Behr², Ralf Heinrich¹

¹Georg-August-University Göttingen, Cellular Neurobiology, Julia-Lermontowa-Weg 3, 37077 Göttingen, Germany

²German Primate Centre, Platform for Degenerative Diseases, Kellnerweg 7, 37077 Göttingen, Germany

The vertebrate-specific cytokine erythropoietin (Epo) is a major regulator of erythropoiesis and a potent cytoprotectant in various tissues including the nervous system. While erythropoiesis is stimulated via the classical receptor EpoR, neuroprotection involves both EpoR and additional alternative Epo receptors. Certain ligands, including the natural Epo splice variant EV-3, cannot stimulate classical EpoR (and erythropoiesis) but mediate neuroprotection via unknown receptors.

The cytokine receptor-like factor 3 (CRLF3) is a cytokine receptor that shares sequence similarity with EpoR and is present in all major taxa ranging from cnidarians to humans. Our previous studies demonstrated that insect CRLF3 initiates anti-apoptotic neuroprotective mechanisms upon stimulation with human Epo and EV-3. Human CRLF3 is expressed in various tissues and has been associated with proliferation, differentiation, cell survival and some diseases, though its concrete function remained elusive.

We studied whether CRLF3 might represent an alternative Epo-receptor that stimulates neuroprotection in the human nervous system. We generated CRLF3 knock out (KO) human induced pluripotent cell (iPSC) lines along with isogenic control lines (Ig-Ctrl), differentiated them into neurons, induced apoptosis by addition of rotenone and quantified cell survival via FACS measurements. CRLF3 was stimulated by EV-3 to exclude coactivation of EpoR. All experiments (5 independent experiments each) compared untreated, stressed and EV-3 treated cells in cultures of wild type, Ig-Ctrl and CRLF3-KO cells. To characterize the means by which EV-3 might protect human iPSC-derived neurons from apoptosis, we performed qPCR to quantify the expression of pro- and anti-apoptotic genes (5 independent experiments for each iPSC line) and calculated statistical relevance by Fishers pairwise permutation test. Validity of results was ensured by conducting all experiments with two individual hiPSC lines.

We demonstrate that EV-3 protects WT and Ig-Ctrl iPSC-derived neurons from rotenone-induced apoptosis. In contrast, CRLF3-KO neurons are not protected, indicating that CRLF3 serves as neuroprotective receptor for EV-3 in human neurons. Moreover, EV-3/CRLF3 signalling regulates expression of pro- and anti-apoptotic genes to favor cell survival.

Altogether, we identify human CRLF3 as a neuroprotective receptor that can be stimulated by EV-3 independently of EpoR coactivation. Hence, CRLF3 can be selectively targeted by Epo-like ligands to counteract neurodegenerative diseases without co-promoting inappropriate erythropoiesis and tumor growth.

New insights in neuropathology and pathogenesis of autoimmune glial fibrillary acidic protein meningo-encephalomyelitis

Verena Endmayr¹, Frank Leypoldt^{2,3}, Katharina Hess^{4,5}, Christoph Röcken⁵, Desiree De Simoni⁶, Stefan Oberndorfer⁶, Ellen Gelpi¹, Simon Robinson⁷, Chad Guthrie⁷, Simon Hametner¹, Romana Hoeffberger¹

¹Division of Neuropathology and Neurochemistry, Department of Neurology, Medical University of Vienna, Vienna, Austria

²Neuroimmunology Section, Institute of Clinical Chemistry, University Medical Center Schleswig-Holstein, Kiel, Germany

³Department of Neurology, University Medical Center Schleswig-Holstein and Kiel University, Kiel, Germany

⁴Institute of Neuropathology, University Hospital Muenster, Muenster, North Rhine Westphalia, Germany

⁵Department of Pathology, University Medical Center Schleswig-Holstein, Kiel, Germany

⁶Department of Neurology, University Hospital St. Poelten, St. Poelten, Austria

⁷High Field Magnetic Resonance Centre, Department of Biomedical Imaging and Image-Guided Therapy, Medical University of Vienna, Vienna, Austria

Background Glial fibrillary acidic protein (GFAP) meningo-encephalomyelitis is an autoimmune disease of the central nervous system (CNS), associated with immunoglobulin type G (IgG) autoantibodies that are directed against the α -subunit of GFAP (GFAP α), a cytosolic intermediate filament protein of astrocytes. Clinical manifestations include meningitis, encephalitis and/or myelitis. Brain magnetic resonance imaging (MRI) may show perivascular radial gadolinium enhancement in the white matter. Since GFAP is a cytosolic protein, pathogenicity of circulating anti-GFAP autoantibodies has not been clarified yet.

Objectives To describe the clinical, neuropathological, and radiological features of anti-GFAP meningo-encephalomyelitis, which may shed light on the pathogenesis of this disease.

Methods We histopathologically analysed two human and one canine autopsy case of anti-GFAP meningo-encephalomyelitis using (immuno)-histochemical stainings on routine and double-hemispheric FFPE brain sections and correlated them with in-vivo and post-mortem MRI. To detect anti-GFAP α autoantibodies, we used a combination of TBA and CBA.

Results Inflammation ranged from a lymphocytic to granulomatous phenotype in the human autopsies and necrotizing meningo-encephalitis in the canine autopsy case. Post-mortem 7 Tesla MRI of FFPE brain tissue of one human autopsy case showed prominent perivascular hyperintensities in the white matter that neuropathologically corresponded to dilated Virchow-Robin-spaces with abundant CD20⁺, CD79a⁺ and CD4⁺ lymphocytic infiltrates. CD8⁺ T cells were mainly found in the brain parenchyma. The granulomatous inflammation was characterized by upregulation of pSTAT1 and numerous CD103⁺ tissue resident memory T cells. GFAP immunohistochemistry revealed an extensive subpial band-like gliosis and reactive astrocytes in the deep cortical sulci in topographical association with meningeal inflammation. In addition, a subpopulation of astrocytes showed an upregulation of MHC class I molecules.

Conclusion GFAP autoimmunity can show different neuropathological phenotypes that range from lymphocytic and granulomatous inflammation to necrotizing meningo-encephalitis. Perivenous inflammation and dilated Virchow-Robin spaces are plausible pathological correlates of linear gadolinium enhancement in-vivo.

Novel targets of glycine receptor autoantibodies in stiff person syndrome

Anna-Lena Eckes¹, Inken Piro², Erdem Tüzün³, Christian Werner⁴, Claudia Sommer²,
Carmen Villmann¹

¹University Hospital Würzburg, Institute for Clinical Neurobiology, Versbacherstr. 5, 97078 Würzburg, Germany

²University Hospital Würzburg, Department of Neurology, Würzburg, Germany

³Istanbul University, Institute of Experimental Medical Research, Istanbul, Turkey

⁴Julius-Maximilians-University of Würzburg, Department of Biotechnology and Biophysics, Würzburg, Germany

Stiff Person Syndrome (SPS) and progressive encephalomyelitis with rigidity and myoclonus (PERM) are rare neurological disorders of the central nervous system. Approximately, half of PERM patients and 20% of SPS patients harbour autoantibodies (aAb) against glycine receptors (GlyRs). GlyRs belong to the superfamily of Cys-loop receptors and enable fast inhibitory neurotransmission in the mammalian spinal cord and brain stem. They form pentameric ligand-gated chloride channels composed of either α homomers located pre- and extrasynaptically, or $\alpha\beta$ heteromers located postsynaptically with a $4\alpha:1\beta$ stoichiometry. Loss of glycinergic function causes an imbalance in neurotransmission with enhanced excitability leading to symptoms like muscle stiffness, spasms and exaggerated startle, typical for SPS and PERM.

At the molecular level, GlyR aAb binding impairs receptor function by direct blocking of the ion channel pore and decreases the amount of surface receptors due to enhanced receptor internalisation. So far, GlyR aAbs have been found to bind to postsynaptic GlyR $\alpha1$, $\alpha2$ and $\alpha3$ subunits. High sequence homology in the extracellular domain between GlyR α and β subunits suggests that GlyR aAbs might also bind the GlyR β subunit. Additionally, GlyR α homomers located at presynaptic sites triggering weakly depolarizing chloride currents upon activation by spill over glycine may represent a target for GlyR aAbs and contribute to the aAb pathology.

Here, we screened serum samples from 58 patients with SPS-like symptoms and found two patients with aAbs not only binding to the GlyR $\alpha1$ but additionally the GlyR β subunit. GlyR β specificity was verified in primary spinal cord neuronal cultures and spinal cord tissue of mice lacking the $\alpha1$ subunit. Quantitative analysis revealed that aAbs bound with the same efficacy to GlyR β colocalizing with its scaffold protein gephyrin in spinal cord neurons with and without expression of GlyR $\alpha1$. Electrophysiological measurements after pre-incubation with GlyR β positive patient serum revealed reduced receptor efficacy for the neurotransmitter glycine.

Furthermore, super-resolution SIM² microscopy of neuronal cultures incubated with ten different SPS patient serum samples revealed that aAbs not only target post- but also presynaptic GlyR α subunits. Cultivation of interneurons have been established to specifically investigate presynaptic GlyRs as a possible target. Ongoing electrophysiological experiments will unravel whether presynaptic targeting of GlyR aAbs plays a role in the disease pathology.

Overall, our systemic analyses of the aAb repertoire of SPS and PERM patients will help to further understand GlyR aAb pathophysiological mechanisms.

Pathology of CASPR2 autoantibodies – investigation of protein expression level and protein-protein interactions within the VGKC

Patrik Greguletz¹, Maria Plötz¹, Michele Niesner², Carmen Villmann², Kathrin Doppler¹

¹Department of Neurology, University Hospital Würzburg, Germany

²Institute for Clinical Neurobiology, University Hospital Würzburg, Germany

CASPR2 autoantibodies were found in patients with different neurological disorders. Some patients show manifestations of the central nervous system (CNS), like limbic encephalitis or insomnia, others are affected by syndromes of the peripheral nervous system (PNS), like neuromyotonia or neuropathic pain. The mechanisms of CASPR2 associated with neuropathic pain are not understood yet. To understand the pathology of CASPR2 autoantibodies will help to find and improve effective treatment for suffering patients. In the PNS, CASPR2 is part of the voltage-gated potassium channel complex (VGKC) which is located within the juxtaparanodal region of myelinated axons. Moreover, pain may also be transmitted by dorsal root ganglia (DRG) neurons to the CNS as DRGs also harbor the same set of proteins in a protein complex. The VGKC is essential for the repolarization of the depolarized membrane. Therefore, a dysfunction of CASPR2 may lead to hyperexcitability of the affected neurons mediating pain signals. With the determination of the IgG subclasses of CASPR2 autoantibodies in patient samples, we did not reveal a correlation between a specific IgG subclass and pain association. Even though, we did not find changes in the CASPR2 expression level in cultured DRG neurons following presence of patient sera with CASPR2 autoantibodies from patients with and without neuropathic pain. Therefore, autoantibodies against CASPR2 most probably exhibit a different pathology. In the current project, we study the protein-protein interactions of the VGKC following binding of CASPR2 autoantibodies.

Within the VGKC, CASPR2 interacts directly with the scaffold proteins 4.1b and indirectly with PSD-95 (fig.1). Protein 4.1b and PSD-95 link CASPR2 to the subunits Kv1.1 and Kv1.2 of the voltage-gated potassium channel type 1. Using Western blots, changes in CASPR2, 4.1b, PSD-95, Kv1.1 and Kv1.2 protein expression in DRG neurons and transfected HEK 293 cells after exposure to anti-CASPR2 positive sera are determined. Long-term (2-4 days) versus short-term (1h) effects are currently investigated.

The resulting information will expand the current knowledge of how CASPR2 autoantibodies can lead to severe neurological dysfunction.

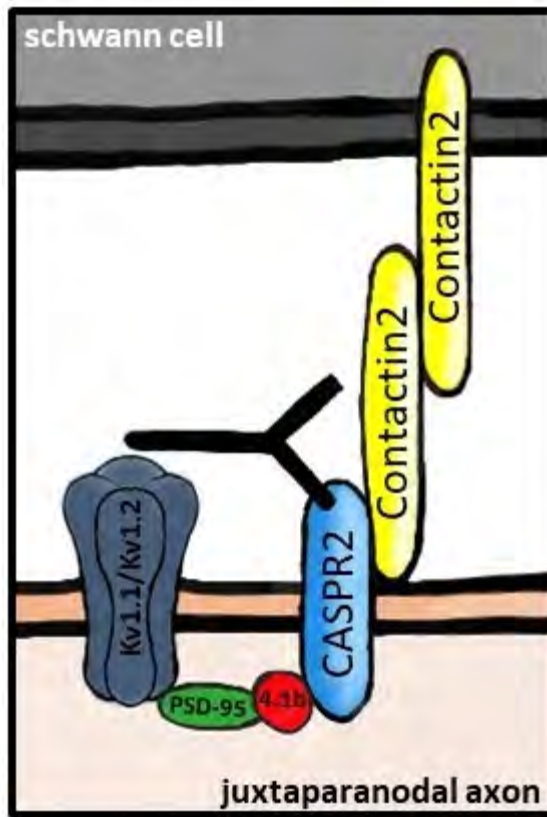

fig. 1: simplified structure of the VGKC showing a potential binding site of an anti-CASPR2 autoantibody.

Poststroke lipid droplet accumulation in residing microglia and its influence on inflammation and phagocytosis

Wei Wei¹, Dirk Fitzner¹, Wenqiang Xin¹, Yongli Pan¹, Irina Graf¹, Lars Tatenhorst¹,
Mathias Bähr¹, Thorsten R Doepfner¹

¹Department of Neurology, University Medical Center Göttingen, Robert-Koch-Str.40, 37075 Göttingen, Germany

Ischemic brain damage is a frequent cause for long-lasting disability in patients affected by stroke. Besides immediate neuronal death and necrotic transformation of the ischemic brain area, inflammation is a regular bystander in stroke lesions. Microglia as the resident macrophages of the central nervous system (CNS) are critically involved in this process, affecting poststroke neurological outcome. Microglia with lipid droplets (LDs) accumulation are dysfunctional in the aged brain and contribute to the poor outcome of neurodegenerative disorders. However, the functional role of this lipid droplet-rich microglia (LDRM) in cerebral ischemic stroke remains unknown. We first isolated primary microglia and subsequently exposed them in vitro to hypoxia by oxygen-glucose deprivation (OGD) and LPS-induced inflammation. We observed lipid droplet (LD) formation in microglia, accompanied by elevated perilipin 2 (PLIN2) expression. In the in vivo mouse model of middle cerebral artery occlusion (MCAO), we further observed massive LDRM aggregation in the cortical infarct core after seven days post-ischemia. In addition, we examined the pattern of lipid metabolism-related genes as well as microglia polarization during ischemia. LDRM exhibited high levels of cytokines TNF- α , IL-6, and IL-1 β , an M1-like proinflammatory phenotype with a high rate of reactive oxygen species (ROS) formation, and high expression of Sterol regulatory element-binding protein 2 (SREBP2), which ultimately activated the NF- κ B signaling pathway. Moreover, high expression of SREBP2 in LDRM upregulated fatty acid synthesis, cholesterol synthesis and esterification, altering the lipid profile and displaying higher free fatty acid and cholesterol levels. This dysregulation of lipid metabolism further exacerbates neuroinflammation and cellular damage. Our study elucidates that distinct lipid profiles lead to LD formation, microglia activation, and impaired tissue regeneration in ischemic stroke and result in the conversion of microglia to a pro-inflammatory phenotype.

Serum anti-AGO1 antibodies identify a patient subgroup of sensory neuropathy responding better to immunomodulatory treatment

Christian Moritz^{1,2,3}, Yannick Tholance^{2,3,4}, Pierre-Baptiste Vallayer¹, Le-Duy Do^{2,5}, Sergio Muñoz-Castrillo^{2,5}, Véronique Rogemond^{2,5}, Karine Ferraud^{1,2}, Coralie La Marca^{2,4}, Jérôme Honorat^{2,5}, Martin Killian^{6,7,8}, Stéphane Paul^{7,8,9}, Jean-Philippe Camdessan^{1,2,3,5,10}, Jean-Christophe Antoine^{1,2,3,5,10}

¹ Department of Neurology, University hospital of Saint-Etienne, 42055 Saint-Etienne, France

² Synaptopathies and Autoantibodies (SynatAc) Team, Institut NeuroMyoGene, MELIS, INSERM U1314/CNRS UMR 5284, Université Claude Bernard Lyon 1, Lyon, France

³ Faculty of Medicine, University Jean Monnet, Saint-Étienne, 42270 Saint-Priest-en-Jarez, France

⁴ Department of Biochemistry, University hospital of Saint-Etienne, 42055 Saint-Etienne, France

⁵ French Reference Center on Paraneoplastic Neurological Syndrome, Hospices Civils de Lyon, Hôpital Neurologique, 69500 Bron, France

⁶ Department of Internal Medicine, University hospital of Saint-Etienne, 42055 Saint-Etienne, France

⁷ CIRI – Centre International de Recherche en Infectiologie, Team GIMAP (Saint-Etienne), Université Claude Bernard Lyon 1, Inserm, U1111, CNRS, UMR5308, ENS Lyon, UJM, F69007 Lyon, France.

⁸ CIC Inserm 1408 Vaccinology, F42023 Saint-Etienne, France.

⁹ Department of Immunology, University Hospital of Saint-Etienne, Saint-Etienne, France10

¹⁰ European Reference Center for Rare Neuromuscular Diseases, 42055 Saint-Etienne Cedex 02, France

Background: Autoantibodies (Abs) improve diagnosis and treatment decisions of idiopathic neurological disorders. Recently, we identified Abs against Argonaute proteins (AGO) as potential autoimmunity biomarkers in neurological disorders. Here, we aim to reveal 1) the prevalence of AGO1 Abs in sensory neuropathy (SNN), 2) titers and IgG subclasses, and 3) their clinical pattern including response to treatment.

Methods: This retrospective multicentric case/control study screened 132 patients with SNN, 301 with non-SNN neuropathies, 274 with autoimmune diseases (AID), and 116 healthy controls (HC) for AGO1 Abs via ELISA. Seropositive cases were also tested for IgG subclasses, titers, and conformation specificity.

Results: AGO1 Abs occurred in 44 patients, comprising significantly more SNN [17/132 (12.9%)] than non-SNN neuropathies [11/301 (3.7%); $p = 0.001$], AID [16/274 (5.8%); $p = 0.02$], or HC [0/116; $p < 0.0001$]. Abs titers ranged from 100-100,000. IgG subclass was mainly IgG1, and 11/17 AGO1 Abs-positive SNN (65%) had a conformational epitope. AGO1 Abs-positive SNN was more severe than AGO1 Abs-negative one (e.g., SNN score: 12.2 vs. 11.0, $p = 0.004$) and more frequently responded to immunomodulatory treatments than AGO1 Abs-negative SNN (7/13 [54%] vs. 6/37 [16%], $p = 0.02$). Multivariate logistic regression adjusted for potential confounders showed that AGO1 Abs-positivity was the only predictor of response to treatment (OR 4.93, 1.10-22.24 95% CI, $p = 0.03$).

Conclusions: AGO Abs-positive SNN have a specific clinical pattern and more frequently respond to immunomodulatory treatments independently of their autoimmune context. This may warrant the search of AGO1 Abs in SNN in clinical practice.

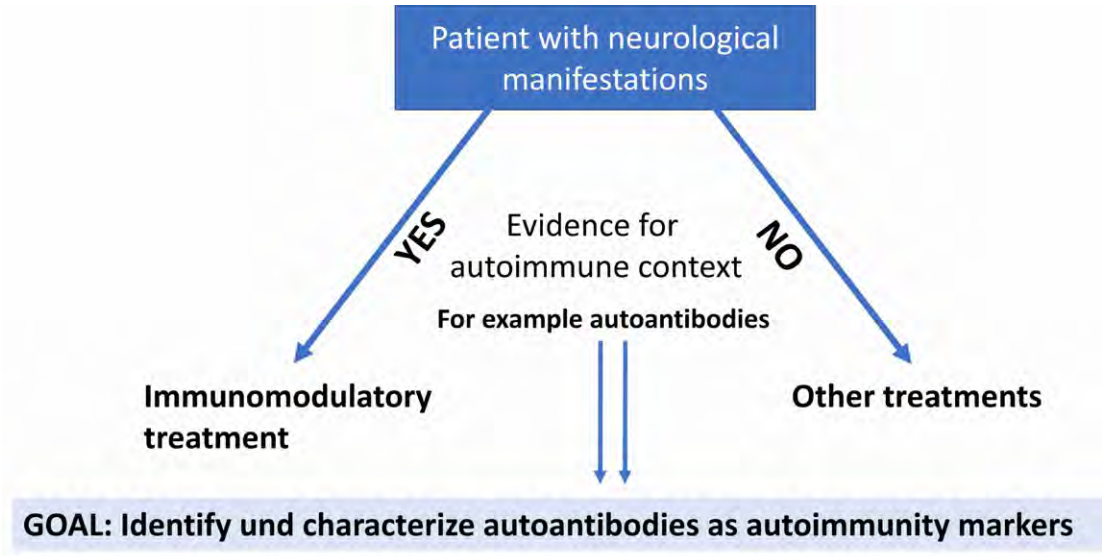

Pre-traumatic antibiotic-induced depletion of the gut microbiome reduces neuroinflammatory response in acute murine traumatic brain injury

Katharina Ritter¹, Diana Vetter¹, Michael KE Schaefer¹

¹University Medical Centre Mainz, Department for Anaesthesiology; Neuroprotection, Langenbeckstrasse 1, 55131 Mainz, Germany

Background: Alterations of the intestinal microbiome have been linked to interfere with pathological processes in a wide spectrum of neurological diseases and antibiotic treatments are a frequent cause of severe disturbance of the resident microbial colonization. (1) This study investigates the effects of a pre-traumatic depletion of the gut microbiome in the early period after experimental traumatic brain injury.

Material and methods: 40 male C57BL/6 mice were randomized in two groups. One (AB, n=20) received a combined oral antibiotic treatment with vancomycin, amoxicillin/clavulanic acid and nystatin while the other was supplied with regular drinking water (veh, n=20). After 14d treatment was switched to regular drinking water in all animals and mice were subjected to right parietal controlled cortical impact (CCI) or sham procedure (CCI/AB, CCI/veh each n=12; sham/AB, sham/veh each n=8). Neuromotor impairment was assessed by Neurological Severity Score (NSS) and Rotarod test (RR), 72 h after TBI mice were euthanized and brains were removed in toto. Cerebral lesion volume was determined by sequential cryosectioning and volumetry while perilesional brain tissue was analysed for several (neuro-)inflammatory markers by qPCR, Western Blot and immunohistochemistry. To verify sufficient microbial depletion faeces samples were collected after 14d of antibiotic treatment, analysed by MALDI-TOF and compared to those of vehicle treated mice. Statistics: Rout Outlier test, Shapiro-Wilk, t-Test/Mann-Whitney-U-test, One-way-/Two-way-ANOVA, p<0.05.

Results: MALDI-TOF analyses revealed significant depletion of microbial faecal spectrum after 14d of antibiotic treatment. Mice of the CCI groups showed severe neuromotor impairment compared to sham animals 72h after injury (p<0,001) which was not affected by the antibiotic treatment, also lesion volume did not vary significantly between both groups subjected to cerebral trauma. IgG extravasation in the perilesional brain tissue, assessed by immune-dot blot was significantly reduced by microbial depletion 72h after injury as well as mRNA-expression of IL-1 β , C3, TSPO and MHC2.

Conclusion: Pre-traumatic depletion of intestinal colonization attenuates blood-brain-barrier impairment and inflammatory response 72h after experimental TBI, while lesion volume and neuromotor impairment remain unaffected. Further investigations are necessary to explore the neuroprotective value of these findings and to delimit potential of-target effects of the antibiotic treatment.(2)

1. Sundman MH, Chen N, Vignesh S, Chou Y: The bidirectional gut-brain-microbiota axis as a potential nexus between traumatic brain injury, inflammation, and disease. *Brain, Behaviour, and Immunity* 2017;66:31-44

2. Eigenbrod T, Bode KA, Dalpke AH: Early Inhibition of IL-1 β Expression by IFN γ is mediated by impaired binding of NF κ B to the IL-1 β Promoter but is independent of Nitric Oxide. *The Journal of Immunology* 2013;190:6533.6541

Role of BDNF/TrkB and pro-BDNF/p75^{NTR} signaling in modulating the microglia functional state in the aging brain

Yesheng Sun¹, Marta Zagrebelsky¹, Martin Korte^{1,2}

¹ Zoological Institute, Division of Cellular Neurobiology, Spielmannstraße 7, 38106 Braunschweig, Germany

² Neuroinflammation and Neurodegeneration Group, Helmholtz Centre for Infection Research, Braunschweig, Germany.

Signaling of BDNF and its precursor proBDNF via their receptors TrkB and p75^{NTR} in the brain regulates several physiological processes including the development of the neuronal network, its functional and structural plasticity and learning and memory processes. While BDNF-TrkB signaling mediates neuroprotective and plasticity promoting effects, proBDNF-p75^{NTR} is involved in regulating neuronal death. BDNF has been shown to be expressed also in microglia, the resident macrophages in the brain and is suggested to regulate their activation state. Interestingly, while BDNF decreases, proBDNF has been shown to increase in the brain with age leading to a shift in the BDNF/proBDNF ratio in favor of the pro-form associated with a progressive alteration in the microglia activation state, so-called priming. However, the mechanisms underlying the priming of microglia in aging remain elusive and a possible role of the age-dependent changes in BDNF-TrkB and proBDNF-p75^{NTR} signaling in this context is not understood. Since microglia activation is involved in several neurological conditions, including age-related neurodegenerative diseases to analyze how specific manipulations of the BDNF/proBDNF signaling might influence microglia priming and how in turn the activation state of microglia may affect BDNF synthesis and release in aging is especially interesting.

In primary microglia cultures, both wild-type (WT) and *bdnf*KO^{het} microglia respond in a concentration-dependent manner to activation by Lipopolysaccharide (LPS) application with the secretion of the pro-inflammatory cytokines TNF- α ; and IL-6. The secretion of TNF- α ; is significantly higher and the one of IL-6 is significantly lower in the *bdnf*KO^{het} cells compared to WT. Next, we investigated whether BDNF/proBDNF might modulate the LPS-induced microglial activation. Thus, WT primary microglia were treated for 24 hours with increasing concentrations (2, 50 and 100ng/ml) of recombinant BDNF or uncleavable proBDNF then stimulated with LPS (100ng/ml). Interestingly, the lower doses of BDNF and proBDNF suppress the production of IL-6. Moreover, upon LPS stimulation p75^{NTR}KO microglia release significantly less IL-1, IL-6 and TNF- α ; compared to WT. In vivo p75^{NTR}KO microglia shows a reduced complexity and alteration in process motility.

Overall our results so far demonstrate that treatment with BDNF and proBDNF modulate the inflammatory status of activated microglia in a dose-dependent manner. Moreover, we identified a possible involvement of p75^{NTR} signaling modulating the structure and motility of microglia. Current experiments expand these results to the in vivo condition.

Spatial transcriptomics identifies local and cell type-specific pathophysiological changes in a mouse model of sepsis-associated encephalopathy

Nina Hahn^{1,2}, Martin Bens³, Marco Groth³, Christian Geis^{1,2}

¹University Hospital, Hans Berger Department of Neurology, Section of Translational Neuroimmunology, Am Klinikum 1, 07747 Jena, Germany

²Center for Sepsis Control and Care, Jena University Hospital, Am Klinikum 1, 07747 Jena, Germany

³Leibniz Institute on Aging-Fritz Lipmann Institute (FLI), Beutenbergstraße 11, 07745 Jena, Germany

Sepsis-associated encephalopathy (SAE) is a serious complication in sepsis survivors leading to a long-term cognitive dysfunction. This cerebral dysfunction is caused by a severe systemic inflammation without a specific infection of the central nervous system. While the incidence of sepsis is increasing, the mortality of sepsis is decreasing leading to a growing number of patients suffering from chronic SAE. Since these patients have a high risk of repeated hospitalizations or are in need of nursing, SAE is a burden to the health care system as well. However, the etiology of SAE is still mainly elusive and appropriate therapies are missing, so far. Hence, it is of high importance to investigate the pathogenesis of sepsis-induced encephalopathy in order to develop therapeutic approaches. To this end, we established a murine model of polymicrobial sepsis relying on peritoneal contamination and infection (PCI).

We applied spatial transcriptomics that, in contrast to bulk or single-cell RNA sequencing, preserves spatial information. This approach provides a comprehensive insight into the transcriptome level of SAE related to tissue architecture. It thereby allows to unbiasedly investigate local interactions and gene expression with respect to tissue geography. In addition, we combined spatial transcriptomics with immunofluorescent stainings targeting astrocyte and microglia markers on the identical tissue section to integrate additional data from the protein level. This further characterizes and helps to define particular regions of interest with respect to the morphology of glia cells.

Synaptic network dysfunction and increased intrinsic neuronal excitability in GluA2 autoimmune encephalitis

Yang Yuan¹, Christian Geis¹, Holger Haselmann¹

¹University Hospital of Jena, Department of Neurology, AG Geis, Am Klinikum 1, 07747 Jena, Germany

Autoimmune encephalitis (AE) is a new group of neurological disorders induced by autoantibodies (aAB) against distinct neuronal surface antigens such as α -amino-3-hydroxy-5-methyl-4-isoxazolepropionic acid receptor (AMPA). As epilepsy is a characteristic feature of AMPA receptor encephalitis, we aim to investigate the effect of anti-GluA2 (AMPA subunit) aABs on the neuronal network and the balance of excitation and inhibition as a prerequisite for increased susceptibility to seizures.

We performed intra-parenchymal injections of anti-GluA2 aABs into the hippocampus area of mice and prepared acute brain slices after 24 hours incubation. We hypothesized a dysbalance of the excitatory to inhibitory ratio (I/E ratio) and performed stimulation of Schaffer-collateral pathway to evaluate glutamatergic and bisynaptic GABAergic signalling on the single cell level in CA1 pyramidal neurons. Moreover, we investigated the influence of anti-GluA2 aABs on intrinsic neuronal excitability.

The I/E ratio of spontaneous and evoked postsynaptic currents was altered after anti-GluA2 aABs treatment. The intrinsic excitability of neurons showed increasment due to anti-GluA2 autoantibodies. In addition, anti-GluA2 antibodies increased significantly the action potential firing rate after Schaffer-collateral stimulation. Anti-GluA2 autoantibodies affect hippocampal networks and the intrinsic excitability of neurons. They can influence synaptic transmission of postsynaptic AMPARs Our results contribute to the understanding of the epileptogenic potential of anti-GluA2 aABs and may help to identify optimized treatment strategies in controlling epilepsy in AMPAR AE.

Tauroursodeoxycholic acid as a treatment of spinal cord injury

Jörg Mey^{1,2}, Lorenzo Romero-Ramírez¹, Concepción García-Rama¹, Siyu Wu^{1,2}, Boris W. Kramer²

¹Hospital Nacional de Paraplégicos, Neural Regeneration, c/La Peraleda, 45071 Toledo, Spain

²Euron Graduate School of Neuroscience, Maastricht University, Netherlands

Background: Tauroursodeoxycholic acid (TUDCA) is a bile acid with anti-inflammatory effects on microglia and macrophages. Implants of bone marrow-derived stromal cells (bmSC) are currently under investigation in clinical trials of spinal cord injury (SCI). We studied the therapeutic effect of TUDCA and a combinatorial treatment with human bmSC in a rat model of SCI.

Methods: Spinal cord contusion injury was induced at thoracic level T9. Treatment consisted of 2 or 5 injections of 100 mg/kg or 300 mg/kg TUDCA, combined with one sub-occipital injection of human bmSC into the cisterna magna. Control groups received injections of saline, TUDCA or bmSC treatments only. Functional recovery was assessed during a surveillance period of six weeks. Rats were sacrificed after 4 days for biochemical and histological investigation or after 6 weeks for histology.

Outcome: Treatment with TUDCA improved the recovery of autonomic bladder control and had a positive effect on motor functions in the subacute phase. Biochemical analysis of spinal cord tissue confirmed its anti-inflammatory activity including effects on cytokines and pyruvate kinase M2, a regulator of glucose metabolism. Effects on motor function were only transient, however, such that no significant differences between vehicle and TUDCA-treated animals were observed 1-6 weeks after lesion. Combinatorial treatment with TUDCA and bmSC failed to have an additional effect compared to treatment with bmSC only. Our data do not support the use of TUDCA as a treatment of SCI.

The astrocytic-microglial crosstalk leads to a HIF-1 α -nitric oxide positive feedback loop during hypothalamic inflammation

Francesco Arioli¹, Olaf Jöhren²

¹Institute for Experimental and Clinical Pharmacology and Toxicology, University of Lübeck, Lübeck, 23562, Germany

²Center for Brain, Behavior and Metabolism (CBBM), University of Lübeck, Lübeck, 23562, Germany

Hypoxia inducible factors (HIFs) are involved in the cellular response and adaptation to low oxygen concentrations. HIF-1 α stabilization following exposure to physiological oxygen concentrations (termed physioxia, 3-5% in the brain) or hypoxia (1%) affects the expression of its target genes involved in a variety of different processes, such as angiogenesis, erythropoiesis, cell proliferation, survival and metabolism. Therefore, culturing cells at the correct oxygen concentrations becomes fundamental for studying metabolic changes induced by HIFs. Moreover, HIF-1 α protein stability can be induced by nitric oxide (NO) while HIF-1 α promoter activity can be stimulated by the activation of the main inflammatory pathway NF- κ B. In hypothalamic murine mixed glial cultures, consisting of astrocytes and microglia, we confirmed HIF-1 α stabilization and activity both at physioxia (3%) and hypoxia. Additionally, we showed that the pro-inflammatory stimuli lipopolysaccharide (LPS) and interleukin-1 β (IL-1 β) greatly increased HIF-1 α activity, as evidenced by the protein stabilization and upregulation of its target genes involved in glycolysis, such as LDHA, PDK1 and lactate transporter MCT4. Interestingly, the HIF-1 target gene NO synthase (iNOS) displayed the strongest upregulation, which was greatly dampened by pre-treatment with the NO-chelating agent cPTIO. This suggested a role for NO in the cellular metabolism switch from oxidative phosphorylation to glycolysis. Moreover, inhibition of the NF- κ B pathway was enough to counteract the upregulation of HIF-1 α target genes induced by IL-1 β and LPS. Finally, we identified a reduction in the HIF-1 response to inflammation by microglial ablation, highlighting a possible crosstalk with astrocytes. Here we propose a positive feedback loop during hypothalamic inflammation, which occurs in metabolic diseases such as obesity. We suggest that the activation of NF- κ B increases the activity of the HIF-1 α pathway via the HIF-1-dependent upregulation of iNOS and the NO-dependent HIF-1 protein stabilization, ultimately leading to increased lactate production in astrocytes and microglia.

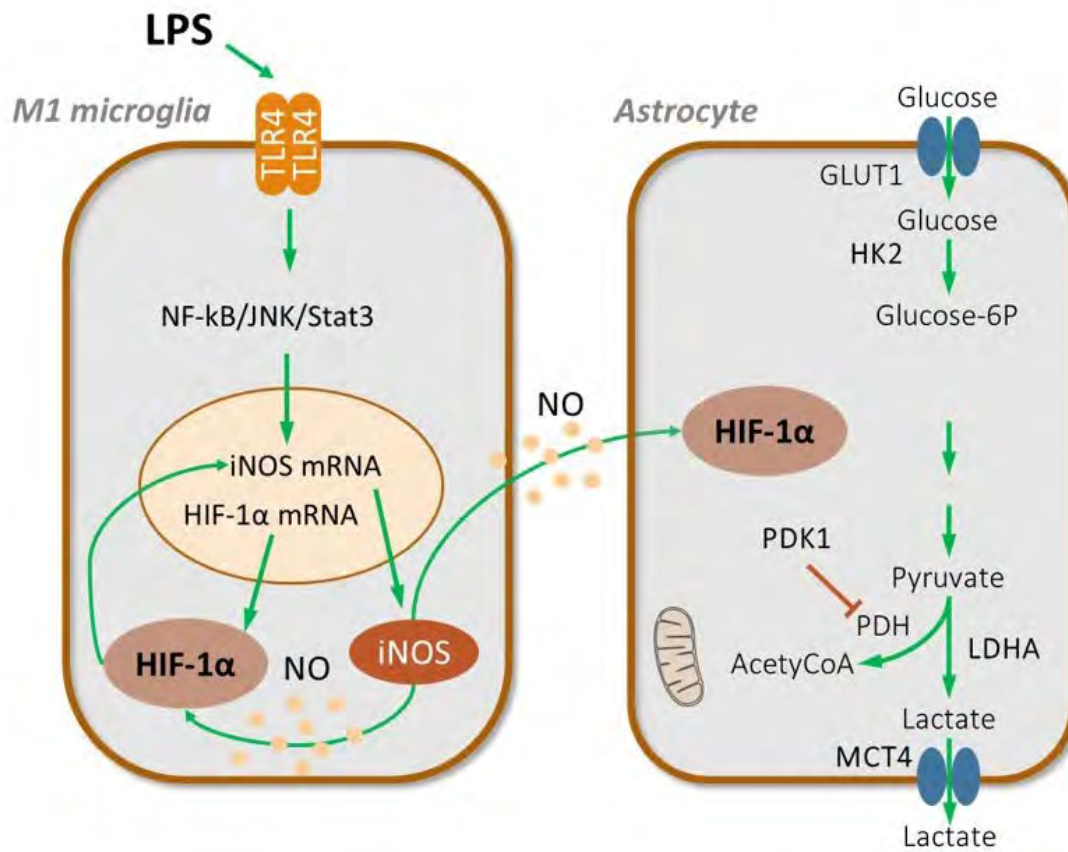

Proposed model for glial cells interaction in the hypothalamic inflammation.

The potential therapeutic role of itaconate and mesaconate on the detrimental effects of neuroinflammatory processes in the brain

Melanie Ohm^{1,2}, Shirin Hosseini^{1,3}, Karsten Hiller², Martin Korte^{1,3}

¹Department of Cellular Neurobiology, Zoological Institute, TU Braunschweig, Germany

²Department of Bioinformatics and Biochemistry, TU Braunschweig, Germany

³Helmholtz Centre for Infection Research, Neuroinflammation and Neurodegeneration Group, Braunschweig, Germany

Numerous studies indicate that strong inflammatory responses in the periphery during various bacterial and viral infections lead to infiltration of peripheral leukocytes into the central nervous system, resulting in activation of brain-resident immune cells, neuroinflammation, and possibly even neurodegeneration. The inflammatory response is primarily a protective mechanism to inhibit pathogens. However, excessive and chronic inflammation can lead to detrimental effects on neuronal structure and function. In fact, neuroinflammation underlies the pathogenesis of many neurological and neurodegenerative diseases and accelerates their progression. Therefore, inflammatory signaling pathways have been implicated as potential therapeutic targets for many neurological diseases. A growing number of reports indicate that products of cellular metabolism play an important role in mediating the immune response. The citric acid cycle (TCA) derived metabolite itaconate is strongly upregulated in activated macrophages and has been shown to act as an immunomodulator with anti-inflammatory functions. Mesaconate, an isomer of itaconate, also decreases the inflammatory response in macrophages. To investigate the immunomodulatory and therapeutic potential of itaconate and mesaconate in neuroinflammatory processes, the metabolites were administered in different treatment conditions: Lipopolysaccharide (LPS)-induced sepsis and influenza A virus infection in WT mice. To analyze the extent of local inflammation, pro-inflammatory cytokines were determined in the central nervous system (CNS). Interestingly, mice that received mesaconate during H7N7 influenza A virus infection showed lower cytokine expression compared with control mice, which was associated with a modulation of microglial density and activity. However, administration of itaconate and mesaconate in the LPS-induced sepsis model resulted in lower cytokine levels compared with the corresponding control animals. Ongoing experiments are investigating whether administration of itaconate or mesaconate can modulate microglial activation and neuronal structure and function. These results could lead to new therapeutic strategies to prevent immediate and delayed neurological manifestations associated with strong peripheral inflammatory responses after bacterial and viral infections.

The role of polyinosinic:polycytidylic acid (Poly I:C) as a viral mimetic on glutamate clearance by astrocytes and microglia

Xizi Shi^{1,2}, Shirin Hosseini^{1,2}, Kristin Michaelsen-Preusse¹, Martin Korte^{1,2}

¹Department of Cellular Neurobiology, Zoological Institute, TU Braunschweig, Spielmannstr. 7, 38106 Braunschweig, Germany

² Neuroinflammation and Neurodegeneration (NIND), Helmholtz Centre for Infection Research (HZI), Inhoffenstr. 7, 38124 Braunschweig

Glutamate, the major neurotransmitter in the central nervous system (CNS), mediates the majority of excitatory signals. Disruption of glutamate homeostasis leads to neuropathological sequelae, as impaired glutamate homeostasis is associated with various neurodegenerative diseases. EAAT1 (GLAST) and EAAT2 (GLT-1), the most representative glutamate transporters in the CNS, are highly expressed on astrocytes, which are responsible for maintaining physiological extracellular glutamate concentrations. Elevated levels of pro-inflammatory cytokines, produced in many inflammatory conditions, have been linked to dysfunctions of the glutamatergic system. This in turn can lead to increased brain excitability and excitotoxicity observed in various pathological conditions.

In this study, polyinosine:polycytidylic acid (Poly I:C), an agonist of Toll-like receptor 3 (TLR3) as a viral infection mimetic, was used to stimulate primary cultures consisting of neurons, astrocytes and microglia. Neuronal excitability as well as synapse number were analyzed. Moreover, cytokine levels were determined. In a second set of experiments ceftriaxone, a drug that can increase GLT-1 expression levels, was tested as a potential therapeutic approach.

We can show that TNF- α and IL-6 levels were increased following Poly I:C stimulation, this increase could be prevented by application of ceftriaxone. In addition, Poly I:C stimulation increased baseline activity in neurons expressing the calcium indicator GCaMP6 and chemical induction of long-term potentiation (LTP) was impaired. Further experiments will now reveal whether ceftriaxone can also prevent alterations in synapse number and neuronal excitability.

Poster Topic

T13: Cognitive, Emotional, Behavioral State Disorders and Addiction

- [T13-1A](#) Adolescent social stress: Neuroimmunological signatures of stress susceptibility
Tobias Tilmann Pohl, Hanna Hörnberg
- [T13-2A](#) An interoceptive role for glycinergic periaqueductal grey neurons during defensive states
Sara Cristina Lourenço dos Reis, Jérémy Signoret-Genest, Philipt Tovote
- [T13-3A](#) Analysis and comparison of dendritic spine density of pyramidal neurons in NEX-Cre and C57Bl/6J mice
Kim Laura Renken, Olivia Andrea Maseck
- [T13-4A](#) Assessing sex differences and effects of repetitive acute stress on an animal model of depression
Lisa Ratz, Volker Arnd Coenen, Máté Daniel Döbrössy
- [T13-5A](#) Botanicals Can Induce Resilience to a Depression-Like State in *Drosophila melanogaster*.
Helen Holvoet, Burkhard Poeck, Doris Kretzschmar, Amala Soumyanath, Roland Strauss
- [T13-6A](#) Does chronic stress alter the hippocampal stress engram?
Jonas Cornelius, Kristin Michaelsen-Preusse, Martin Korte
- [T13-7A](#) Enhanced amygdala activity by social fear conditioning but not object fear conditioning
Sukwon Lee, Juno Yeo
- [T13-1B](#) Heavy alcohol drinking during adolescence compromises GABAergic inhibition in adult mouse dentate gyrus granule cells
Fang Zheng, Christian Alzheimer
- [T13-2B](#) Impact of brain serotonin deficiency in development and behaviour in postnatal life
Laura Boreggio, Niccolò Milani
- [T13-3B](#) In vivo noradrenaline release following medial forebrain bundle deep brain stimulation in rodents: the impact of different stimulation parameters
Zhuo Duan, Lidia MiguelTelega, Yixin Tong, Volker Arnd Coenen, Máté Dániel Döbrössy
- [T13-4B](#) iTBS changes in frontoparietal functional and structural connectivity correlated with clinical improvement in depression

Asude Tura, Roberto Goya-Maldonado

- [T13-5B](#) Neurofeedback based interventions for emotional states regulation
César Redondo, Jérémy Signoret-Genest , Philip Tovote
- [T13-6B](#) Psychostimulant-induced neuroinflammation: Clarifying astrocyte-microglia crosstalk under IL-10
Carolina Pinto, Ana Isabel Silva, Margarida Saraiva, Teresa Summavielle
- [T13-1C](#) Quantifying social behaviors in juvenile Shank3 mice using animal pose estimation tools
Rosalba Olga Proce, Madhu Nagathihalli Kantharaju, Hanna Hörnberg
- [T13-3C](#) Social stress as a depression induced factor in submissive rats
Tamar Domianidze, Tamar Matitaishvili, Keso Kozmava
- [T13-4C](#) The Input-Output relationship of Ventral Tegmental Area in a Rodent Model of Depression
Yixin Tong, Seonghee Cho, Volker Arnd Coenen, Mate Daniel Döbrössy
- [T13-5C](#) Training and pharmacological modulation enhance learning in rats overexpressing the dopamine transporter
Nadine Bernhardt, Henriette Edemann-Callesen, Maximilian Glienke, Esther Olubukola Akinola, Maike Kristin Lieser, Christine Winter
- [T13-6C](#) Utilizing chemogenetic strategies in nonhuman primates to assess the role of amygdala activation in the expression of anxiety-related behaviors
Sascha Mueller, Jonathan A. Oler, Nakul Aggarwal, Patrick H. Roseboom, Marissa K. Riedel, Victoria R. Elam, Miles E. Olsen, Alexandra H. DiFilippo, Bradley T. Christian, Xing Hu, Adriana Galvan, Matthew A. Boehm, Michael Michaelides, Ned Kalin

Adolescent social stress: Neuroimmunological signatures of stress susceptibility

Tobias Tilmann Pohl¹, Hanna Hörnberg¹

¹Max Delbrück Center for Molecular Medicine in the Helmholtz Association, Molecular and Cellular Basis of Behavior, Robert-Rössle-Str. 10, 13125 Berlin, Germany

Social relationships are important throughout life and the social environment during development is fundamental in shaping future social behavior. The adolescent period is a time of high brain plasticity, and disturbances of the social environment during this time can have detrimental long-lasting effects on the brain circuits regulating social behaviors. The neuroimmune system, including microglia, is an important regulator of neurodevelopment and behavioral responses. Altered neuroimmune responses due to stress can have long-lasting effects on neuronal and social/cognitive functioning. Therefore, we aim to explore how social stress during the critical window of adolescence affects the brain's neuroimmune system and how this is linked to stress vulnerability.

We will apply a translational model for social stress in both male and female mice that rely on frequently changing social group composition. We then will assess the individual stress vulnerability based on a battery of behavioral tests and investigate its link to the neuroimmune system using spatial proteomics.

An interoceptive role for glycinergic periaqueductal grey neurons during defensive states

Sara Cristina Lourenço dos Reis¹, Jérémy Signoret-Genest¹, Philipt Tovote¹

¹Institute for Clinical Neurobiology, System Neuroscience, Versbacherstr. 5, 97078 Würzburg, Germany

Fear and anxiety are defensive states that evolved as responses to threat. Inappropriate selection and inability to rapidly switch between defensive states are hallmarks of fear- and anxiety-like disorders. Defensive states encompass a multitude of coordinated and integrated responses, such as behavioral and autonomic changes. Afferent signaling reporting the body's physiological state, a process termed interoception, is crucial to regulate these emotional states. The midbrain periaqueductal grey (PAG) critically contributes to defensive states, however, it remains poorly understood how its neuronal substrates encode and integrate interoceptive signals as part of a defense reaction. Using virally mediated trans-synaptic retrograde tracing, we found that PAG glycinergic neurons receive monosynaptic inputs from the nucleus of solitary tract (NTS) and rostral ventral medulla (RVML), cardiac regulatory areas within the medulla. Anterograde tracing revealed that the PAG glycinergic neurons project massively project to forebrain and midbrain regions, such as the hypothalamus, but not to brainstem cardiac centers, suggesting that these neurons report cardiac information to higher order brain regions. Using deep brain calcium imaging with a miniaturized microscope, we observed that high fear states correlate with an increase in active PAG glycinergic neurons, and this activation was strongly associated with an increase of heart rate. Furthermore, optogenetic manipulation confirmed an engagement of PAG glycinergic neurons in controlling heart rate by preventing bradycardic microstates induced by conditioned cues. Additionally, optoactivation increased heart rate variability, suggesting an involvement of these neurons in maintaining cardiac macrostate dynamics within physiological levels. Interestingly, specific optoactivation of the interoceptive pathway NTS-glycinergic PAG neurons only shown an effect in the microstate, suggesting that macrostate interoceptive dynamics might depend on higher order control. Overall, our findings uncover a novel glycinergic brainstem circuit involved in defensive states via regulating cardiac interoception, thereby adding to our understanding on how bodily states influence emotions.

Analysis and comparison of dendritic spine density of pyramidal neurons in NEX-Cre and C57Bl/6J mice

Kim Laura Renken¹, Olivia Andrea Masseck¹

¹University of Bremen, Synthetic Biology, Leobener Straße 5, 28359 Bremen, Germany

Major depressive disorder (MDD) is one of the most common mental disorders worldwide and has been associated with several behavioral and cellular abnormalities. One of the key symptoms of MDD is anhedonia, which is characterized by a decreased ability of experience pleasure from rewarding activities. Anhedonia in mice can be measured by sucrose preference test (SPT). Furthermore, it has been shown that depression is highly associated with alternations of dendritic morphology and spine density like a decreased spine density in the prefrontal cortex (PFC) and the hippocampus (Hip) but an increased spine density in the basolateral amygdala (BLA) and the nucleus accumbens (NAc). NEX-Cre mice (Goebbels et al., 2006) are transgenic mice in which the Cre recombinase is introduced into the NEX locus to achieve endogenous NEX expression in glutamatergic neurons of the telencephalon (Goebbels et al., 2006). We observed an altered behavior in the SPT: Behavioral experiments with C57Bl/6J and NEX-Cre (-/-) mice indicate that the NEX-Cre mouse strain show anhedonic behavior in the SPT compared to the C57Bl/6J mice. To analyze these results at the cellular level, the Golgi Cox staining technique is used to quantify and compare the dendritic spine density of C57Bl/6J and NEX-Cre (-/-) mice in depression-associated brain areas such as PFC, Hip, BLA and NAc. Overall, the combination of behavioral experiments and systematic histological analysis of dendritic spines will provide new insights into possible mechanism of depressive disorders.

Goebbels, S., Bormuth, I., Bode, U., Hermanson, O., Schwab, M. H., & Nave, K.-A. (2006). Genetic targeting of principal neurons in neocortex and hippocampus of NEX-Cre mice. *Genesis*, 44(12), 611–621. <https://doi.org/10.1002/dvg.20256>

Assessing sex differences and effects of repetitive acute stress on an animal model of depression

Lisa Ratz^{1,2,5}, Volker Arnd Coenen^{1,3,4,5,6}, Máté Daniel Döbrössy^{1,2,3,6,7}

¹Laboratory of Stereotaxy and Interventional Neurosciences, Department of Stereotactic and Functional Neurosurgery, University Hospital Freiburg, Freiburg, Germany

²Faculty of Biology, University of Freiburg, 79104 Freiburg im Breisgau, Germany

³Department of Stereotactic and Functional Neurosurgery, University Hospital Freiburg, Freiburg, Germany

⁴BrainLinks-BrainTools, IMBIT (Institute for Machine-Brain Interfacing Technology), University of Freiburg, 79110 Freiburg im Breisgau, Germany

⁵Faculty of Medicine, University of Freiburg, 79110 Freiburg im Breisgau, Germany

⁶Center for basics in neuromodulation, University of Freiburg, Germany

⁷Corresponding author

INTRODUCTION: Depression is a common psychiatric disorder resulting in severe reduction in life quality. Women, twice as likely to be diagnosed, show differences in symptoms and treatment response. Sexual dimorphism has only recently been studied experimentally and the underlying mechanisms remain poorly understood. The Flinders Sensitive Line (FSL) rat model shows several depressive-like symptoms and an overall passive stress response. Other symptoms like anhedonia are not expressed, but can be induced in the FSLs through chronic mild stress (CMS) protocols. Using a longitudinal design, the study aimed to evaluate a.) the sex specific differences in FSLs exposed to an acute stress in form of an extended open space swim test (OSST) protocol and b.) to test if acute repetitive stress is sufficient to induce anhedonia.

METHODS: Fifty-six rats were used in the study, half FSLs (n=28) and half SD Controls (n=28). Half of all groups were male (M) and half female (F), and assigned to the acute stressed (STR) or unstressed (CON) conditions (n=7 in all 8 experimental groups). Animals underwent FST to form matched experimental groups. Next, four rounds (R1-R4) of behavioral testing were carried out, with each round separated by 1 week (Fig. 1). A round consisted of Open field (OFT), Elevated plus maze (EPM), Sucrose consumption test (SCT) and OSST. For the acute stress condition, the OSST consisted of 24 min of swimming on 3 consecutive days, while the control condition groups only underwent 1 day of swimming for 15 min. Post OSST, the groups were retested on SCT to determine the development of anhedonia. In the F rats, estrous cycle stages monitoring was done on a daily basis during behavioral sessions to investigate the influence of estrogen on the phenotype and stress response.

RESULTS: In the FST, M and F FSLs had significantly higher immobility compared to SD controls. Interestingly, within the experimental groups the FSL F; but SD M showed higher immobility. SDs were more mobile in the OFT and EPM, although these behaviors remained a strong trend and significant group differences in anxiety were not demonstrated. During R1, FSLs –but not SDs - showed clear acute stress induced decrease in mobility in the OSST versus controls across both sexes, which persisted in R2-R4. In later rounds FSL controls also showed reduced swimming but to a much lesser extent in M versus the stressed animals. SDs showed only a slight reduction in mobility over the course of each test. In R1, signs of anhedonia could be detected in the SCT of stressed FSLs, more pronounced in M, but not in unstressed FSLs or SD controls. This effect could not be reproduced in R2-R4. Additional results will be reported at GNS23.

CONCLUSION: The data suggests a more pronounced depressive phenotype in FSL F; than M; in the FST, indicating that the observed sex differences in depression might also be present in this model. The persistent reduction in swimming distance in the OSST of FSLs but not SDs could suggest an enhancement of the depressive phenotype of FSL M due to this repeated acute stress. Although a change in symptom severity could not be observed in other tests and the induced anhedonia in R1 was only transient. The ongoing analysis will determine the effects of the estrous cycle on the behavior as well as possible differences in gene expression between stressed FSLs and SDs to help to understand the role of estrogen and stress in the gender dimorphism in depression.

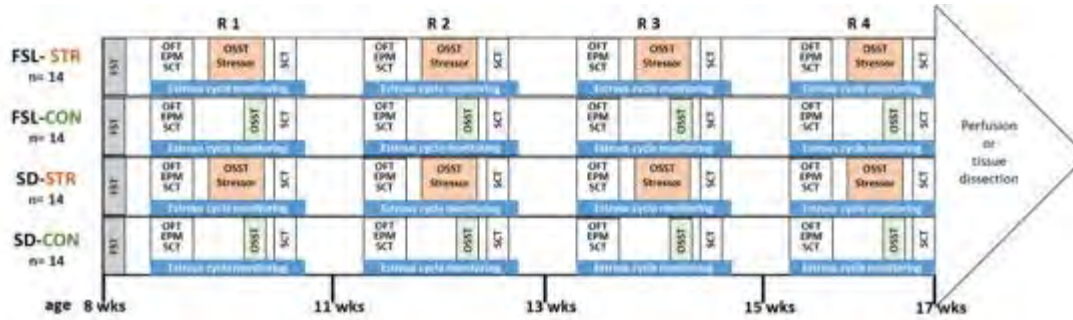

Fig. 1 Experimental plan. In total 56 FSL animals and SD controls were tested. To quantify the depression phenotype in the FSL line, the immobility in the FST was measured in 8 week old animals and used to form balanced groups which later underwent acute stress, in form of an extended OSST protocol, or remained unstressed as controls. All stressed and unstressed groups consisted of half male half female animals, leading to a total of 8 different experimental groups. All groups went through 4 rounds of testing .

Botanicals Can Induce Resilience to a Depression-Like State in *Drosophila melanogaster*.

Helen Holvoet¹, Burkhard Poeck¹, Doris Kretzschmar², Amala Soumyanath³, Roland Strauss¹

¹Johannes Gutenberg Universität, Institut für Entwicklungsbiologie und Neurobiologie, Hanns-Dieter-Hüsck-Weg 15, 55099 Mainz, Germany

²Oregon Institute of Occupational Health Sciences, Oregon Health and Science University, Portland, OR, USA

³Department of Neurology, Oregon Health and Science University, Portland, OR, USA

Chronic, uncontrollable stress can result in psychiatric syndromes including anxiety and major depressive disorder (MDD) in humans and animals alike. Several days of chronic stress can induce depression-associated behavioural alterations in *Drosophila* flies, accompanied by overall changes in biogenic amine levels in the adult brain. We have developed a chronic stress paradigm, where flies are subjected to three days of repetitive phases of 300Hz vibrations combined with overcrowding and food deprivation, which reduces the motivation to perform voluntary behaviours. This includes the motivation to climb an insurmountable gap (*risk taking*) or to stop at a sweet tasting strip (*anhedonia*), suggesting a depression-like state (DLS). These behavioural changes correlate with decreased serotonin release to the α -lobes of the mushroom body, a major behavioural control centre in the central brain of the fly. Notably, the observed behavioural changes could be relieved by feeding flies 5% sucrose solution or lithium chloride (LiCl), a mood stabilizing salt often used in treatment of MDD (Ries et al. 2017; Hermanns et al. 2022). Here we show that continuous LiCl treatment can relieve from the DLS but does not induce prophylactic resilience to stress. Similarly, only continuous food supplementation with the antioxidant γ -oryzanol, a by-product of rice bran oil (Araujo et al. 2021), also has a relieving effect on stressed flies. Next we asked if botanicals that are used to treat stress disorders in traditional Asian (Ayurvedic) medicine, might act as adaptogens in stressed flies. We show that food supplementation with water- or ethanol-root extracts of *Withania somnifera* ("Ashwagandha") indeed ameliorates the behavioural deficits in stressed flies (Holvoet et al. 2022). Surprisingly, prophylactic treatment with Ashwagandha did convey resilience to stress in both behavioural paradigms. Future studies aim to identify the active compound(s) and their targets molecules to improve therapeutic strategies.

Araujo et al. (2021). γ -Oryzanol produces an antidepressant-like effect in a chronic unpredictable mild stress model of depression in *Drosophila melanogaster*. *Stress* 24(3): 282-293.

Hermanns et al. (2022). Octopamine mediates sugar relief from a chronic-stress-induced depression-like state in *Drosophila*. *Curr. Biol.* 32(18): 4048-4056.e3

Holvoet et al. (2022). *Withania somnifera* extracts promote resilience against age-related and stress-induced behavioral phenotypes in *Drosophila melanogaster*; a possible role of other compounds besides Withanolides". *Nutrients* 14(19): 3923.

Ries et al. (2017). Serotonin modulates a depression-like state in *Drosophila* responsive to lithium treatment. *Nat. Commun.*, 8(1): 15738.

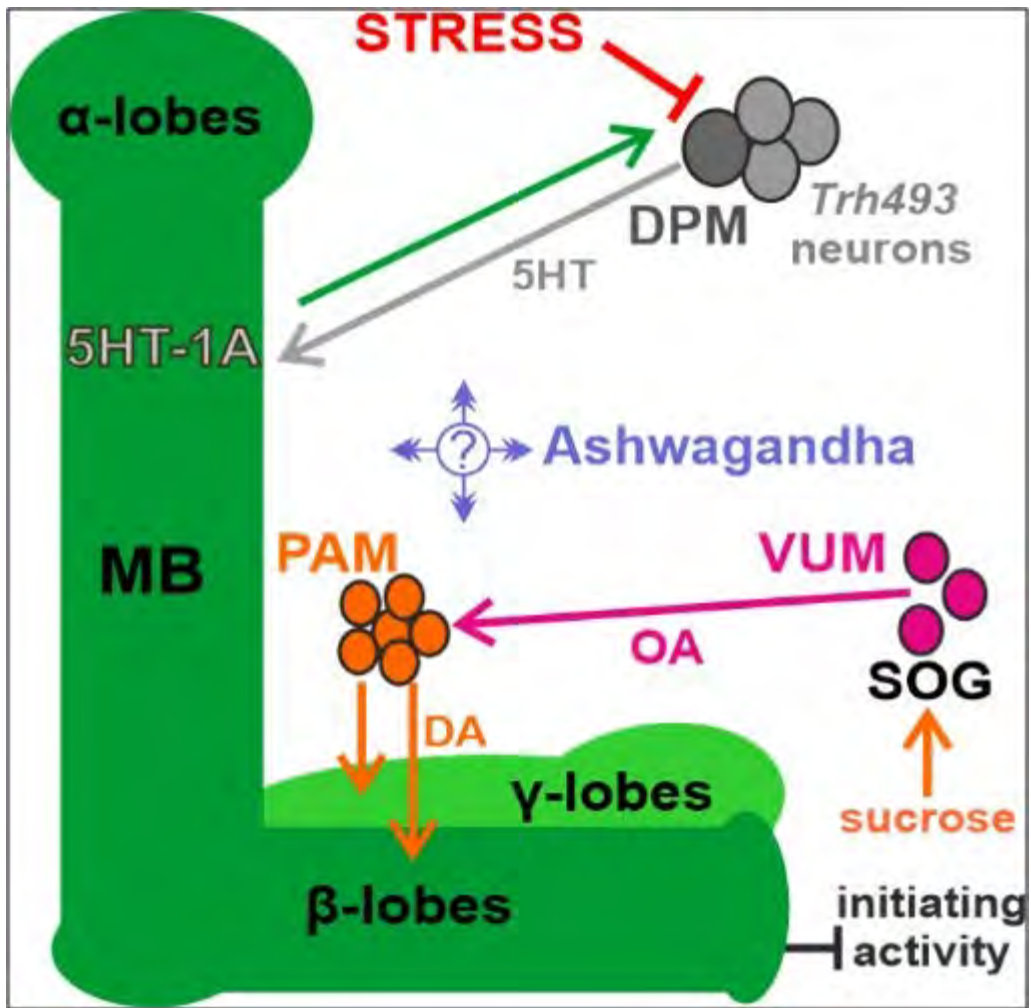

Relief of a depression-like state in *Drosophila*.

Does chronic stress alter the hippocampal stress engram?

Jonas Cornelius¹, Kristin Michaelsen-Preusse¹, Martin Korte^{1,2}

¹Division of Cellular Neurobiology, Zoological Institute, TU Braunschweig, Germany

²Helmholtz Centre for Infection Research, Research group Neuroinflammation and Neurodegeneration, Braunschweig, Germany

When left untreated, chronic stress exposure leaves adverse effects on the human cardiovascular, immune as well as central nervous system and has been correlated to the development of a broad range of serious mental diseases including anxiety disorders, insomnia as well as major depressive disorder (MDD). Although the physiology of stress is fairly well understood, the exact molecular mechanisms mediating the interplay between stress and mental illness on a single-cell level remain yet elusive. Research from the last decades suggests that one of the main causes for MDD is a hyperactivation of the hypothalamic-pituitary-adrenocortical (HPA) axis - a system that is typically involved in response to stressful events and which induces high levels of circulating cortisol in the bloodstream. This leads to an inhibition of inflammation, increases glucose metabolism in the brain and impairs functions that would be nonessential in a fight-or-flight situation. Importantly, cortisol is also crucially involved in terminating the stress cascade through an activation of the hippocampus and thereby helps to return the body to a pre-stress steady-state. In MDD, however, constant high levels of cortisol have been shown to induce degeneration and damage in the hippocampus as they were found to induce neuronal loss, reduced neuronal complexity, alterations in signal transduction efficacy and a loss of adult neurogenesis. Ultimately, it is believed that, as a result of chronic stress, the hippocampus loses its ability to help to properly terminate the stress response, thereby favoring permanently high and uncontrolled levels of stress hormones which can then facilitate further brain damage.

In the work presented here, we aim to gain a better understanding of the molecular mechanisms mediating neuropathological features of hippocampal neurons in response to chronic stress as this might be an essential step in the development of stress-related mental illnesses. For this, we utilize an AAV-based, inducible engram labelling system to identify and analyze hippocampal neurons which were activated in the context of chronic immobilization stress in mice – the ‘stress engram’. Finally, we aim to analyze morphological features of neurons comprising the stress engram as well as analyze the specific role of the actin cytoskeleton and stress-regulated actin-binding proteins in the stress-induced neuropathology of hippocampal neurons.

J.C. and M.K. are funded via the DFG Project ‘KO 1674/33-1’

Enhanced amygdala activity by social fear conditioning but not object fear conditioning

Sukwon Lee¹, Juno Yeo¹

¹Korea Brain Research Institute, Developmental disorders research group, 61 Cheomdan-ro, 41062 Daegu, Korea (South)

Social fear is a fear of social situations, and known to precede other psychiatric disorders, such as general anxiety disorders, affective disorders, and abuse disorders. Therefore, understanding the neural mechanisms of social fear and developing a therapy for social fear is needed. However, the neural mechanisms of social fear are not fully studied yet.

To study social fear-specific neural mechanisms, we use social fear conditioning and object fear conditioning paradigm with C57BL/6 male mice. After social or object fear conditioning, the subject mouse showed robust fear against the social partner or object, and the neural excitability of the amygdala was increased in both groups. However, in the basolateral amygdala, a subset of neurons projecting axon terminals in the medial prefrontal cortex (BLA->mPFC neurons) showed increased neural excitability only after social fear conditioning but not object fear conditioning. In addition, the inactivation of the activity of BLA->mPFC neurons by optogenetic method attenuated the fear response to the social partners. Taken together, these results indicate that BLA to mPFC pathway is involved in social fear memory.

Heavy alcohol drinking during adolescence compromises GABAergic inhibition in adult mouse dentate gyrus granule cells

Fang Zheng¹, Christian Alzheimer¹

¹University of Erlangen-Nürnberg, Institute of Physiology and Pathology, Universitätsstr. 17, 91054 Erlangen, Germany

Excessive alcohol consumption during adolescence is regarded as a risk factor for the development of alcoholism later in life, but the pathophysiological mechanisms that render the adult brain susceptible to alcohol are largely unknown. GABA_A receptors are among the targets of alcohol to regulate neural activity in the brain. Work from our lab has demonstrated that activin, a member of the TGF- β family, controls alcohol potentiation of GABA_A receptors in adult mouse dorsal hippocampus. Considering the well-known functional segregation along the hippocampal longitudinal axis, here we studied how adolescent alcohol drinking affects adulthood GABAergic inhibition and its response upon alcohol re-exposure, by performing whole-cell voltage-clamp recordings from dentate gyrus granule cells in dorsal and ventral hippocampal slices from adult mice (3-4 months old). Compared to control mice, heavy drinking in the dark (20% alcohol, two-bottle choice paradigm) between postnatal days 32 and 45 produced a long-lasting reduction in synaptic and extra-synaptic GABAergic inhibition in ventral, but not dorsal, granule cells of adult mice. Moreover, the inhibitory synaptic drive onto granule cells in both hippocampal regions from adolescent drinking mice exhibited less potentiation upon acute alcohol exposure compared to alcohol-naïve mice. Interestingly, the lasting impact of the adolescent drinking paradigm was largely absent in transgenic mice expressing a dominant-negative mutant of activin receptor IB (dnActRIB) in forebrain neurons, which disrupts activin receptor signaling. Our results show that heavy adolescent drinking has a long-term impact on the hippocampal GABA system and its response to acute alcohol consumption in adulthood, and substantiate the notion that activin plays a crucial role therein.

Impact of brain serotonin deficiency in development and behaviour in postnatal life

Laura Boreggio^{1,2}, Niccolò Milani^{1,2}

¹Max Delbrück Center for molecular medicine (MDC) , Michael Bader group, Robert-Rössle-Straße 10, 13125 Berlin, Germany

²The Serotonin & Beyond project, European Union's Horizon 2020 research and innovation programme, No. 953327

Brain serotonin deficiency in rodents affects early postnatal growth and survival of the pups, triggering behavioural alterations and problems in social communication (Alenina et al 2009). I am presenting a project that aims at understanding the causal link between low levels of serotonin in the pre- and postnatal phase and growth retardation and altered behaviour - as well as its effects on PFC development. To do that we are using a knockout rat model lacking brain serotonin, TPH2-KO.

To tackle growth retardation, we are monitoring the metabolic profile in rodents lacking tph-1 or tph-2 under different types of diet. We are measuring the energy expenditure of these animals while also assessing the hypothalamus-pituitary-adrenal axis function using a proteomic approach. The plan also includes monitoring the growth rate and PFC development using histological techniques and MRI. To determine the origin of the alterations we treat animals with 5-HTP postnatally to see whether they can recover a normal phenotype, by looking at gene expression, epigenetic signatures and behavioural profiling.

In vivo noradrenaline release following medial forebrain bundle deep brain stimulation in rodents: the impact of different stimulation parameters

Zhuo Duan^{1,2}, Lidia MiguelTelega^{1,2,3,4}, Yixin Tong^{1,2,3}, Volker Arnd Coenen^{1,2,5}, Máté Dániel Döbrössy^{1,2,3}

¹Laboratory of Stereotaxy and Interventional Neurosciences, Department of Stereotactic and Functional Neurosurgery, University Hospital Freiburg, Freiburg, Germany

²Department of Stereotactic and Functional Neurosurgery, University Hospital Freiburg, Freiburg, Germany

³Faculty of Biology, University of Freiburg, 79104 Freiburg im Breisgau, Germany

⁴BrainLinks-BrainTools, IMBIT (Institute for Machine-Brain Interfacing Technology), University of Freiburg, 79110 Freiburg im Breisgau, Germany

⁵Faculty of Medicine, University of Freiburg, 79110 Freiburg im Breisgau, Germany

Background: Major depressive disorder (MDD) is the most common psychiatric disorder affecting over 300 million people worldwide and about 20-25% of the diagnosed patients fail to respond to any conventional treatments. Over the past decade, superolateral medial forebrain bundle (slMFB, human) deep brain stimulation (DBS) has been tested in clinical trials for drug-refractory depression and demonstrated promising anti-depressive effects. However, its mechanism of action remains elusive. Noradrenaline (NA) as a stress-regulating monoamine plays an important role in etiology and pathophysiology of depression. The A1, A2, and A6 NA neurons project to forebrain structures through medial forebrain bundle (mfb, rodents). In this study, we investigate i.) the distribution of the NA projections in prefrontal cortex (PFC, A6) and nucleus accumbens (NAC, A1, A2); and ii.) NA release in the PFC and NAC by unilateral mfb stimulation with different stimulation parameters.

Methods: *Anatomy.* Four male Sprague Dawley (SD) rats (8-10 weeks old) were stained with anti-Dopamine β -Hydroxylase (D β H) antibody using the DAB method. Three male SD rats were bilaterally injected with AAV2-hsyn-eYFP anterograde tracer at LC. Later the rats were perfused and brain slices were stained by anti-Tyrosine Hydroxylase (TH) and anti-D β H. *Fiber photometry.* An initial pilot, including 3 male SD rats, was completed to measure real-time in-vivo NA release under 5s high frequency (130Hz) in 100 μ s/250 μ s/350 μ s pulse width (PW) mfb DBS. Each group receive unilateral mfb DBS electrode implantation and ipsilateral AAV-hsyn-NE2m NA sensor injection followed by optic fiber implantation in PFC (n=1) and NAC (n=2). Next, twelve male SD rats will be matched into 2 groups (PFC, n=6; NAC, n=6). Animals will undergo the DBS stimulation according to a pre-determined protocol (20*5s low (30Hz) and high frequency (130Hz) with 100 μ s/250 μ s/350 μ s PW stimulation each day). The baseline and post-stimulation NA release patterns will be calculated and compared.

Results: D β H positive fiber from A1, A2, A6 project ventrolaterally by forming clear ventral and dorsal NA bundles (VNAB and DNAB) later join into mfb superiorly next to A10 DA fibers (TH positive subtracts D β H positive). D β H positive fibers were found in PFC and posterior NAC shell. Anterograde tracing from LC illustrates A6 fibers project to PFC via DNAB. From the fiber photometry pilot study: mean baseline activity dynamic score from the repetitions were similar in all PWs (AUC for all PWs in PFC: 86.1 \pm 65.6 a.u.; in NAC: -37.3 \pm 46.9 a.u.). Following baseline, 5s 130Hz unilateral mfb DBS induced a remarked increase in

the NE activity in both PFC and NAC: AUC = 437.2 ± 67.1 a.u., max. peak= 14.9 ± 1.4 a.u in PFC; and AUC= 248.5 ± 126.6 a.u., max. peak= 13.1 ± 3.1 a.u. in NAc (mean for all PW). 250 μ s PW induced the largest noradrenaline release in both regions (PFC: AUC= 524.4 a.u., max. peak=17.0 a.u; NAC: AUC=494.9 a.u., max. peak=18.2 a.u.). All parameters are expressed as z-scores.

Conclusion: NA neurons project to forebrain structures (PFC, A6; NAC, A1, A2) through the superior part of mfb next to A10 DA fibers. Acute NA release in PFC and NAC has been detected during the pilot study in which 250 μ s pulse width induced the largest NA increase. The data set will be completed to strengthen the evidence and the downstream molecular mechanism will be further investigated and reported on at the conference.

iTBS changes in frontoparietal functional and structural connectivity correlated with clinical improvement in depression

Asude Tura¹, Roberto Goya-Maldonado¹

¹Laboratory of Systems Neuroscience and Imaging in Psychiatry (SNIP-Lab), Department of Psychiatry and Psychotherapy, University Medical Center Göttingen (UMG), Göttingen, Germany

Major depressive disorder (MDD) is a prevalent disorder, characterized by episodes of depressed mood and loss of interest or pleasure. Additional to these key symptoms, most patients also suffer from cognitive impairments, such as deficits in working memory (WM). WM is a cognitive function that allows us to temporarily retain information and support the performance of daily tasks. Aberrant prefrontal activity and frontoparietal network (FPN) functional connectivity (FC) were proposed as the neural underpinnings of the WM deficits seen in MDD. Widespread decreased structural connectivity (SC) in the white matter tracts that connect the frontal regions has also been reported in MDD compared to healthy controls. Yet, how these aberrant neural patterns may change after treatment remains unresolved, especially after alternative therapy options like intermittent theta burst stimulation (iTBS). The aim of the study is to examine whether potential changes in WM performance and neural correlates (FPN activity, FC, and SC) relate to iTBS-driven clinical improvement in MDD. To address these research questions, 80 patients with MDD were randomized to active and then sham iTBS, or vice-versa, in this quadruple-blind, sham-controlled, crossover study. Twenty sessions of active and sham accelerated iTBS were delivered to the left dorsolateral prefrontal cortex. Functional magnetic resonance imaging (fMRI) during the n-back task, a widely used task for addressing WM, and diffusion tensor imaging scans, for inspecting the SC, were acquired before and after both stimulation protocols. Clinical and behavioral data were analyzed with R. Neural activity and psychophysiological interaction (PPI) analysis during the n-back task was performed with SPM12. fMRI-guided correlational tractography was performed with DSI-Studio. We see decreased neural activity in the right middle frontal gyrus (MFG), and decreased FC between the right superior parietal lobule (SPL) and the MFG after iTBS controlled for sham ($p_{FWEc} < 0.001$). The decrease in right FPN FC was positively correlated with decrease in severity of depression ($r = 0.27$ $p < 0.05$). Moreover, the changes in FA in bilateral inferior fronto-occipital fasciculus and right superior longitudinal fasciculus II were correlated with change in severity of depression ($p_{FDR} < 0.05$). According to our knowledge, this is the first sham-controlled study to show the effects of iTBS on FPN activation and FC during a WM task in patients with MDD. Our results indicate that the change in FC and SC within the FPN correlate with clinical improvement. These findings hint towards the normalization of the aberrant neural activity, FC and SC alongside successful treatment.

Neurofeedback based interventions for emotional states regulation

César Redondo¹, Jérémy Signoret-Genest^{1,2}, Philip Tovote^{1,2}

¹Institute of Clinical Neurobiology, University Hospital Würzburg, Germany.

²Center for Mental Health, University Hospital Würzburg, Germany.

In the face of a threat, the brain generates emotional states, such as fear and anxiety, to trigger adaptive defense reactions to avoid or reduce harm. If those responses are out of proportion to the actual risk, these emotional states lead to maladaptive anxiety disorders.

Anxiety disorders are the most prevalent neuropsychiatric conditions and are characterized by a high degree of heterogeneity in terms of symptoms and causes, which might contribute to the fact that classical pharmacological and psychotherapeutic treatments are not always effective. In the last decade, a lot of research has uncovered brain circuits underlying defensive behavior associated with anxiety disorders. This allows developing more targeted regulatory interventions.

Our aim is the establishment of a murine model for a novel translational approach with prospective therapeutic purposes, based on the Neurofeedback technique (NFB), in which the subject receives online feedback of its own neural activity proportionally transduced into a sensory input. When coupling the targeted modulation of the activity with a reward, the subject can use the feedback information to regulate its own neural activity.

Our strategy uses fiber photometry to register neuronal activity within central defense circuit elements, i.e. neurons of the medial prefrontal cortex (mPFC) or the ventrolateral part of the periaqueductal gray matter (vlPAG). Target activity is coupled with liquid rewards to entrain associative learning and subsequent long-term changes within the selected circuit element. We established an operant NFB training protocol that induces motivation and long performance with high efficiency. Using electrocardiogram and video recordings in mice behavioral tests for fear and anxiety, we assess the cardio-behavioral defensive states before and after NFB. Recorded neuronal activity reflects different elements of the training, such as successful and failed trials, and is differentially modulated by the animals' state. This demonstrates that different elements of the circuits involved in fear and anxiety responses present a basis for NFB training, and preliminary observations suggest modulation of defensive behavior by NFB training.

Our findings present a starting point for the development of translationally relevant, more specific NFB interventions as the basis for targeted "circuit therapy" for anxiety-related disorders.

Psychostimulant-induced neuroinflammation: Clarifying astrocyte-microglia crosstalk under IL-10

Carolina Pinto^{1,2}, Ana Isabel Silva^{1,3}, Margarida Saraiva⁴, Teresa Summavielle^{1,5}

¹Addiction Biology – i3S- Instituto de Investigação e Inovação em Saúde and Instituto de Biologia Molecular e Celular (IBMC), University of Porto, 4200-135 Porto, Portugal

²Faculty of Medicine of Porto, University of Porto, 4100-319 Porto, Portugal

³Instituto de Ciências Biomédicas Abel Salazar (ICBAS), University of Porto, 4050-313 Porto, Portugal

⁴Immune Regulation - i3S- Instituto de Investigação e Inovação em Saúde and Instituto de Biologia Molecular e Celular (IBMC), University of Porto, 4200-135 Porto, Portugal

⁵Escola Superior de Ciências da Saúde, Allied Health School of Porto, Porto, Portugal

Methamphetamine (Meth) is a highly addictive psychostimulant. The classic hallmarks of Meth-exposure are usually associated with disruption of the dopaminergic and glutamatergic systems. However, Meth is now also recognized for causing glial reactivity. In this context, our lab has recently demonstrated that microglia reactivity under Meth-exposure is mediated by the astrocytic release of glutamate in a TNF-dependent manner. Therefore, resorting to successful ways of counterbalancing this reactivity may be protective against Meth.

Our preliminary data showed that overexpression of IL-10, an anti-inflammatory cytokine, in a mouse model seems to confer protection against Meth-induced effects, namely behavioral alterations and microgliosis.

Here, we aimed at determining the role of IL-10 overexpression for each glial cell population, namely microglia and astrocytes. We aimed at clarifying how the presence or absence of IL-10 would affect the nature of the crosstalk between glial cells under Meth-exposure. To do so, primary cell cultures of astrocytes were treated with Meth and recombinant IL-10. In these cells, we intended to assess the release and production of TNF and glutamate. In primary microglial cells, treated with Meth and IL-10, we investigated if IL-10 could prevent increased expression of ROS, iNOS, CD68, and pro-inflammatory cytokines.

Our results showed that IL-10 can decrease Meth-induced glutamate release from astrocytes and affect TNF production and release in a time-dependent manner. Surprisingly, IL-10 was also seen to increase iNOS, CD68, and ROS. Lastly, this cytokine had no significant effect on IL-1 β production or release in microglial cells. Based on these results, the mechanisms of IL-10 on the central nervous system and its possible future use as a therapeutic strategy for Meth addiction need to be further explored.

Quantifying social behaviors in juvenile Shank3 mice using animal pose estimation tools

Rosalba Olga Proce¹, Madhu Nagathihalli Kantharaju¹, Hanna Hörnberg¹

¹Max Delbrück Center for Molecular Medicine, Robert-Rössle-Str. 10, 13125 Berlin, Germany

Social interaction is a core aspect of mammalian behavior, and alterations in social behaviors are found across many neurodevelopmental and psychiatric conditions. Mice display a range of socioemotional behaviors and are commonly used as models to investigate the neuronal circuits and molecular mechanisms underlying differences in social behaviors. Analyzing social interactions in mice is often done by manual quantification of videos. Although multiple methods for automated tracking have been developed in recent years, reliable tracking and automated behavioral classification of multiple freely-moving unmarked animals have remained challenging. The use of an unbiased classification system in a more naturalistic environment could help obtain a translatable way to study social behaviors, in particular in mouse models for neuropsychiatric conditions.

Here, we use open-source toolkits including DeepLabCut, SimBA, and live mouse tracker (LMT) to track and quantify reciprocal self-selected social interactions in pairs of freely-moving sex- and age-matched animals in a home cage. To study differences in social interaction we use juvenile female and male mice that lack the autism-associated gene Shank3. We show that DeepLabCut can track the movement of two size-matched juvenile mice freely interacting in a home-cage, and behavioral classification using supervised and unsupervised methods can detect differences in social interaction between Shank3 knockout and control mice.

Quantifying behavior in an unbiased way remains a challenge in animal research. We confirm that freely-available open-source toolkits can be used to track and classify self-selected social interactions in a home cage, thereby providing a simple, low-cost solution to analyze social behaviors in age and sex-matched mice.

Social stress as a depression induced factor in submissive rats

Tamar Domianidze¹, Tamar Matitaishvili¹, Keso Kozmava¹

¹Ivane Beitashvili Center of Experimental Biomeidicine

Introduction. In recent decades there has been renewed interest in the use of the social environment in animal models of stress pathology. This is based on the fact that many animal species, including human beings spend most of their daily life in close proximity of conspecifics. It is generally assumed that a focus on social stress enhances the value of animal models. In some species, the social environment can be quite complex with a diversity of hierarchical relationships among group members. Living in a social community implies adaptation to the behavior and presence of other group members. From an evolutionary point of view, such a social structure should be optimal for health, reproduction and survival, but the social structure and environment is not only essential for survival. It can be an important source of social stressors at the same time. The available studies show that social stress induced by formation of a group of rats is used as a model of depression in submissive rats. Though in the conditions of already formed hierarchical relations stressogenic impact on a separate individual from small groups of animals may be used as a social stress model.

Proceeding from this, the aim of our research was to study in small groups of rats the impact of social stress induced by dominant's stressing on the behavior of submissive rats.

Materials and Methods. Experiments were performed on 48 Wistar male rats weighing 200-250g. Animals were divided into 12 groups (8 experimental and 4 control). Each group consisted of 4 male and 2 female rats. In experimental groups dominants were subject to stressing, while dominants in control groups underwent no stressing procedures.

In order to reveal dominant and submissive rats in groups we used two methods enabling the stronger animal to gain a victory during food and water obtaining process. The selection of animals was made via dominant and submissive according to the recorded behavioural parameters.

For the purpose of stressing dominants the immobilization stress model was used. The animals were immobilized in a narrow tube (inset). After daily stressing (2 hours daily for 7-days) of dominant rats, we replaced the animals again to their groups under the usual environmental conditions.

In order to study anxiety and depression like behavior of rats we used "forced swim" and "elevated cross maze" tests.

We determined the concentrations of serotonin in the hypothalamus and corticosterone in the plasma of the rats using an immunoenzyme analyser - ELISA reader. The data were processed statistically according to Student's t criterion.

Results and Discussion. The obtained results demonstrated that after stressing procedure, according to "elevated cross maze" test, time spent on open arms of the elevated cross maze significantly reduced in dominant rats. According to "forced swim" test, duration of immobility did not change. Thus, dominants show enhanced fear that must be evoked by a stressing procedure. After stressing of dominants submissive rats manifested depression-like behavioral changes. In particular, in "elevated cross maze" test, the time spent on open arms decreased, while in "forced swim" test increased duration of immobility. Following a stressing procedure, both in dominants and submissives increased concentration of serotonin in the hypothalamus, especially in submissive ones. In control groups no behavioral and biochemical changes were noted.

Thus, according to the obtained results 7-day stressing of a dominant from a small group of rats resulted in depression-like behavioral changes in submissive rats. Against the background of behavioral changes

serotonine concentration increased in the hypothalamus both in dominants and submissives, suggesting that serotonine is implicated in the stress adaptation mechanism. Therefore we suppose that the influence from the part of a dominant seems to be a stress factor of a social character.

Conclusion. The obtained result show that the stressing of dominants in groups of rats induces depressive-like behavior in submissive ones. The obtained results emphasizes the importance of social stress factors in the development of stress related diseases.

The Input-Output relationship of Ventral Tegmental Area in a Rodent Model of Depression

Yixin Tong^{1,2,3,7}, Seonghee Cho^{1,3,7}, Volker Arnd Coenen^{1,2,4,5,6}, Mate Daniel Döbrössy^{1,2,3,6,8}

¹Lab of Stereotaxy and Interventional Neurosciences (SIN), Dept. of Stereotactic and Functional Neurosurgery, University Freiburg Medical Center, Germany

²Dept. of Stereotactic and Functional Neurosurgery, University Freiburg Medical Center, Germany

³Faculty of Biology, University of Freiburg, Germany

⁴Faculty of Medicine, University of Freiburg, Germany

⁵IMBIT (Institute for Machine-Brain Interfacing Technology), University of Freiburg, Germany

⁶Center for Basics in Neuromodulation, University of Freiburg, Germany

⁷Authors contributed equally

⁸Corresponding Author

Introduction. More than 300 million people suffer from major depressive disorder (MDD, or depression) globally, and up to 30% of the patients can end up being classified as having treatment-resistant depression (TRD). Deep brain stimulation (DBS) is an experimental treatment for the TRD patients. The superolateral branch of the MFB (sIMFB), as part of the mesolimbic and mesocortical pathways, is considered to be associated with the processing of emotions. In clinical trials, sIMFB DBS had promising antidepressant outcomes, although the mechanisms are elusive. Previous Diffusion Tensor Imaging study showed reduced structure connectivity of the sIMFB in depressive patients. Ventral tegmental area (VTA), an important structure of the mesolimbic and mesocortical pathways, plays a key role in reward-orientated behavior, motivation, addiction and several psychiatric disorders such as depression. In order to gain insight into the neural networks associated with depression-like phenotype, we used monosynaptic tracing technique to demonstrate the input mapping of the VTA-nucleus accumbens (NAc) and VTA-prefrontal cortex (PFC) projecting neurons in a rodent model of depression.

Methods. Flinders Sensitive Line (FSL) rats were employed as a rodent model of depression and aged and sex matched Sprague-Dawleys (SD) were used as controls. FSL (n=12) and SD rats (n = 12) were assigned into 3 groups: “VTA-NAc core”, “VTA-NAc shell” and “VTA-PFC”. Animals in each group received a helper virus (AAV-TVA-oG-GFP) into the VTA, followed by a genetical-modified rabies virus (EnvA-RbdG-mCherry) injected into one of the output areas (NAc core, NAc shell or PFC; Figure 1). The modified rabies virus expressed monosynaptically and labelled direct inputs to the VTA-output projecting neurons. The whole brain input mapping between FSL and SDs were compared.

Results. Direct input towards VTA ascending neurons were found in 33 brain areas in the FSL and SD rats. Importantly, differences in input distributions between FSL and SD were identified in the cortex, striatum, globus pallidus (GP), zona incerta (ZI), dorsal raphe (DR), pedunculo-pontine (PPN) and paramedian raphe nucleus (PMnR). Within the experimental groups, input patterns across VTA-NAc core, VTA-NAc shell and VTA-PFC projecting neurons differed in the striatum, substantia nigra (SN) and DR. Overall, differences in connectivity between FSLs and SDs were observed in several neuronal circuits associated with depression.

Conclusion. Our study shows the whole brain mapping of the VTA ascending projecting neurons in a rodent model of depression. The anatomical approach revealed brain areas in the FSLs, including striatum and DR, that innervate mesocortical and mesolimbic pathways differently compared to controls. This highlights

potential network anomalies associated with depression pathologies. Our findings provide better understanding of the therapeutic mechanisms observed following MFB neuromodulation.

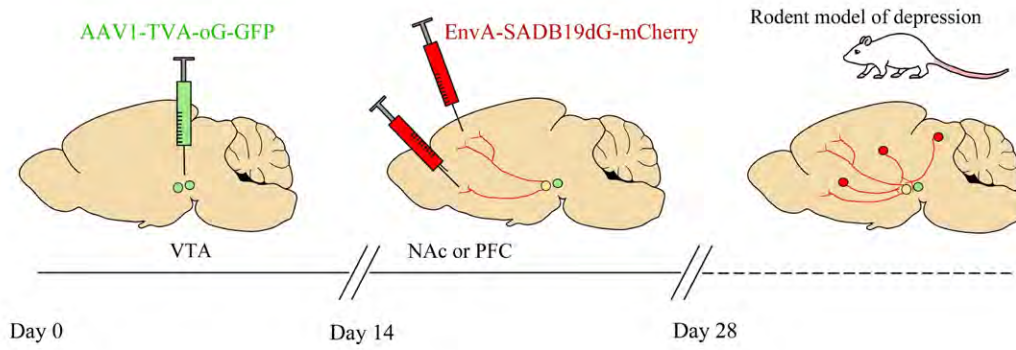

Monosynaptic tracing in a rodent model of depression. AAV expressing TVA and G was injected into the VTA, followed 2 weeks later by RVdG was injected into an output site (NAc or PFC) of VTA neurons. The direct inputs toward specific VTA-outputs were labelled and quantified.

Training and pharmacological modulation enhance learning in rats overexpressing the dopamine transporter

Nadine Bernhardt¹, Henriette Edemann-Callesen², Maximilian Glienke¹, Esther Olubukola Akinola¹, Maike Kristin Lieser¹, Christine Winter²

¹Department of Psychiatrie and Psychotherapy, University Hospital Carl Gustav Carus, Technische Universität Dresden, Germany

²Department of Psychiatry and Psychotherapy, Charité Universitätsmedizin Berlin, Germany

A number of dopamine-dominating neuropsychiatric disorders present with cognitive deficits. In accordance, the dopamine transporter overexpressing rat model (DAT-tg rat) display cognitive deficits by means of behavioral inflexibility and learning disabilities (Bernhardt et al. 2018). However, it was unknown when the inherent dopamine irregularities translate into cognitive deficits during the life course of the DAT-tg rat and what may improve cognitive functioning. Therefore, the Morris water maze (MWM) was used to assess cognitive abilities in DAT-tg rats. In the first cohort, the development of cognitive deficits was assessed by repeatedly testing animals in the MWM at postnatal day (PND) 35, 60, and 90. Minor differences were observed between DAT-tg rats and control rats at PND 35 and 60, whereas cognitive deficits emerged at PND 90. Interestingly, rats subjected early in life to the MWM also displayed improved behavioral flexibility as compared to rats naïve to the paradigm. In a second cohort, pharmacological interventions known to target different aspects of dopamine signaling were applied in adult animals to assess the impact on performance in the MWM and understand what drives, and thus relieves, the deficits. Here the psychostimulant methylphenidate at a dose of 2.5 mg/kg was found to diminish both behavioral inflexibility and improved learning abilities in adult rats. This study showed that cognitive deficits in the ubiquitous DAT overexpression model fully emerge in adulthood and pharmacological modulation has the capacity to overall improves deficits in adult rats. In addition, early training decreases later development of behavioral inflexibility. Thus, former training may constitute a preventive avenue that alters some aspects of cognitive deficits resulting from inherent dopamine abnormalities.

Bernhardt N et al. (2018) Learning deficits in rats overexpressing the dopamine transporter. *Scientific Reports* 8:14173. <https://doi.org/10.1038/s41598-018-32608-7>

Edemann-Callesen H et al. (2022) Former Training Relieves the Later Development of Behavioral Inflexibility in an Animal Model Overexpressing the Dopamine Transporter *Mol Neurobiol* <https://doi.org/10.1007/s12035-022-03029-5>.

Utilizing chemogenetic strategies in nonhuman primates to assess the role of amygdala activation in the expression of anxiety-related behaviors

Sascha Mueller¹, Jonathan A. Oler¹, Nakul Aggarwal¹, Patrick H. Roseboom¹, Marissa K. Riedel¹, Victoria R. Elam¹, Miles E. Olsen¹, Alexandra H. DiFilippo², Bradley T. Christian², Xing Hu³, Adriana Galvan³, Matthew A. Boehm⁴, Michael Michaelides⁴, Ned Kalin¹

¹Department of Psychiatry and the HealthEmotions Research Institute, University of Wisconsin School of Medicine and Public Health, Madison, WI 53719, USA

²Department of Medical Physics, University of Wisconsin School of Medicine and Public Health, Madison, WI 53705, USA

³Yerkes National Primate Research Center, Emory University, Atlanta, Georgia

⁴Biobehavioral Imaging and Molecular Neuropsychopharmacology Unit, National Institute on Drug Abuse Intramural Research Program, National Institutes of Health, Baltimore, MD 21224, USA

Anxiety disorders are some of the most prevalent psychiatric disorders worldwide. Symptoms often begin early in life, and women and adolescent girls are at particularly high risk to develop these disorders. Here, as an opportunity to model and understand the pathophysiology of human pathological anxiety, we utilized DREADDs in a nonhuman primate model of anxious temperament to selectively increase neuronal activity of the dorsal amygdala. Subjects included 10 young female rhesus macaques: 5 unoperated controls, and 5 hM3Dq subjects, which underwent intraoperative MRI surgery to receive bilateral infusions of AAV5-hSyn-HA-hM3Dq into the dorsal amygdala. All subjects underwent behavioral testing in contexts of the human intruder paradigm (HIP) following clozapine or vehicle administration, both prior to and following surgery. Results of linear mixed effects analyses revealed a significant Group (hM3Dq vs. control) x Treatment (clozapine vs. vehicle) x Timepoint (pre vs. post-surgery) interaction, such that, relative to vehicle, clozapine treatment led to greater increases in freezing behavior during the post-surgical period in hM3Dq subjects and not in control subjects. Similarly, a significant Group x Treatment x Timepoint interaction was present for locomotion, such that, relative to vehicle, clozapine treatment led to greater decreases in locomotion during the post-surgical period in hM3Dq subjects, while such decreases were not observed in control subjects. Because the capacity for DREADDs to remain functional over long timespans may be important for long-term studies and clinical applications, we further examined the question of whether DREADD-mediated amygdala activation could continue to produce behavioral changes over prolonged periods of time. Therefore, approximately 1.9 years after surgery, 8 subjects (4 control and 4 hM3Dq) underwent HIP testing again. Clozapine and deschloroclozapine (DCZ), which is a more DREADD-selective derivative of clozapine, were both utilized as DREADD-actuators at this timepoint. When examining the effects of clozapine-mediated hM3Dq-activation on freezing behavior, results demonstrated a significant Group x Treatment interaction, characterized by an increase in freezing in the hM3Dq group as compared to the control group; a significant Group x Treatment interaction was not found for freezing following DCZ administration. Additionally, a significant Group x Treatment interaction was found for locomotion, such that, relative to vehicle, administration of either clozapine or DCZ resulted in decreased locomotion in the hM3Dq group and not the control group. To detect hM3Dq expression in vivo, [11C]-DCZ PET imaging was utilized to visualize

selective binding of hM3Dq-HA in the amygdala of 3 subjects. Post-mortem immunohistochemical examination of these same subjects confirmed prominent hM3Dq-HA expression throughout the amygdala, most notably in neuropil of the basolateral nuclei. Electron microscopy further revealed that hM3Dq-HA receptors were robustly expressed on the cell membrane in both pre- and post-synaptic neuronal elements. Together, these data provide a translational opportunity for understanding the role of amygdala activation in the expression of anxiety-related behaviors during threat-related contexts, as well as proof of concept evidence for the potential use of these methods in humans to modulate the function of neural circuits involved in mediating psychopathology.

Poster Topic

T14: Vision: Invertebrates

- [T14-1A](#) A versatile multi-colour spatial visual stimulus projector for *in vivo* two-photon imaging
Christopher Schnaitmann
- [T14-2A](#) Behavioral exploration of luminance invariance in *Drosophila*
Annika Celine Bast, Madhura D Ketkar, Marion Silies
- [T14-3A](#) Distinct cellular and circuit properties drive differential feature extraction in first order visual interneurons.
Neel Wagh, Katja Sporar, Junaid Akhtar, Marion Silies
- [T14-4A](#) Exploring density-dependent desert locust marching with immersive virtual reality
Sercan Sayin
- [T14-5A](#) From skylight to insect eyes: studying the variability in polarisation patterns and the underlying processing to make a robust navigational compass
Athil Althaf Aliyam Veetil Zynudheen, James Jonathan Foster
- [T14-1B](#) Heterogeneity of synaptic connectivity in the fly visual system
Jacqueline Cornean, Sebastian M. Molina Obando, Jonas Chojetzki, Lena Heike Lörsch, Marion Silies
- [T14-2B](#) Implementation of stable contrast computation in the visual circuits
Burak Gür, Marion Silies
- [T14-3B](#) No direction home: how ants perform systematic searches
Patrick Schultheiss
- [T14-4B](#) Persistent idiosyncratic behavioral traits in *Drosophila melanogaster* depend on individual variability and behavioral context.
Gerit Arne Linneweber, Thomas Mathejczyk, Cara Knief, Muhammad Haidar, Mathias Wernet
- [T14-5B](#) Responses of central-complex neurons of the desert locust to natural sky presentation
Erich M. Staudacher, Keram Pfeiffer, Uwe Homberg
- [T14-1C](#) Six populations of local motion detectors represent optic flow generated during flight
Miriam Henning, Azize Karakut, Burak Gür, Joachim Urban, Marion Silies

- [T14-2C](#) Temperature effects on wide-field motion sensitive neurons in the central brain of bumblebees
Bianca Jaske, Keram Pfeiffer
- [T14-3C](#) The cockroach central complex: Physiology and morphology of single neurons in the brain of *Rhyparobia maderae*
Stefanie Jahn, Vanessa Althaus, Naomi Takahashi, Juliana Schott, Mona Janning, Uwe Homberg
- [T14-4C](#) The dynamic properties of sky-compass neurons in bumblebees during naturalistic stimulation
Lisa Rother, Keram Pfeiffer
- [T14-5C](#) Walking bumblebees see faster
Keram Pfeiffer, Robin Müller, Erwin Kirschenmann, Markus Thamm, Lisa Rother

A versatile multi-colour spatial visual stimulus projector for *in vivo* two-photon imaging

Christopher Schnaitmann¹

¹Johannes-Gutenberg-University Mainz, Institute of Developmental Biology and Neurobiology (iDN), Hanns-Dieter-Hüsch-Weg 15, 55128 Mainz, Germany

For the analysis of visual processing with *in vivo* two-photon imaging, a visual stimulation system is required that offers high spatio-temporal resolution, precise synchronization with physiological equipment, and that is spectrally adapted to the research animal's photoreceptor sensitivities. Commercial displays and projectors, however, are optimized for human vision, are restricted to the use of three colour channels in the visible range, and rarely offer synchronization. Here, we present a versatile visual stimulus projector for the analysis of combined spatial, temporal and spectral response properties and that is adaptable to most visual systems. It is based on a digital light processing module with up to five colour channels and provides more than 100 Hz multi colour frame rate, high spatial resolution, precise synchronization with a two-photon microscope for "fly back" stimulation, and customizable colour combinations. We have adapted this system to suit the analysis of visual processing in *Drosophila* and present a range of stimulus protocols to extract different response properties of neurons of the colour vision circuitry.

Behavioral exploration of luminance invariance in *Drosophila*

Annika Celine Bast^{1,2}, Madhura D Ketkar¹, Marion Silies¹

¹Johannes Gutenberg-University Mainz, Institute of Developmental Biology and Neurobiology, Hanns-Dieter-Hüsich-Weg 15, 55128 Mainz, Germany

²International PhD Programme Mainz, Ackermannweg 4, 55128 Mainz, Germany

* A.C.B. and M.D.K. contributed equally to this work

For behavior to be robust across widely varying visual environments, animals must encode visual cues independently of viewing conditions. For instance, visual systems achieve ‘independence from changing illumination’, or ‘luminance invariance’, by implementing luminance gain control and computing contrast as the relative change of luminance¹. Luminance gain control starts in photoreceptors as they adapt to mean illumination, but this early gain control is insufficient for luminance-invariant contrast estimation, especially in dynamic conditions. For example, a fly suddenly entering a shadow of a tree may underestimate a contrast cue if relying solely on delayed photoreceptor adaptation, leading to inappropriate behavioral responses. Nevertheless, *Drosophila melanogaster*’s behavioral responses to stimuli of high contrast are luminance invariant even under dynamic light conditions². A luminance gain correction necessary to achieve such invariance occurs past first-order visual interneurons and relies on luminance-sensitive first-order interneuron types^{2,3}. It is yet unknown whether this gain correction strategy is required under a wide range of visual statistics and how its properties are shaped by environments comprising different visual statistics, encountered by different strains or species.

Here we show that *D. melanogaster* displays luminance-invariant behavior across a range of contrast cues presented at different timescales. Luminance gain control past photoreceptors is required at both, fast (<1 sec) and slow (>30 sec) time scales. Across all stimulus conditions, the behavior relies on luminance gain correction driven by luminance information preserved in the first-order interneuron type L3. When genetically blocking the output of L3 neurons, the gain correction is hindered, and consequently the flies under- and overestimate contrasts in dim and bright light respectively^{2,3}. We are currently investigating if this cost-intensive strategy generalizes across *Drosophila* strains and *Drosophila* species living in vastly different habitats. Together, our data will reveal if behavior across different environmental conditions is driven by luminance-invariant contrast computation, and if the neuronal mechanisms underlying such a computation are shaped differently by distinct visual environments.

Citations

¹ Laughlin S.B., The role of sensory adaptation in the retina. *The Journal of Experimental Biology* 146:39-62 (1989).

² Ketkar M.D. and Sporar K. et al., Luminance Information Is Required for the Accurate Estimation of Contrast in Rapidly Changing Visual Contexts. *Current Biology* 30, 657–669 (2020).

³ Ketkar M.D., Gür B. and Molina-Obando S. et al., First-order visual interneurons distribute distinct contrast and luminance information across ON and OFF pathways to achieve stable behavior. *eLife* 11:e74937 (2022).

Distinct cellular and circuit properties drive differential feature extraction in first order visual interneurons.

Neel Wagh¹, Katja Sporar¹, Junaid Akhtar¹, Marion Silies¹

¹Institute of Developmental Biology and Neurobiology, Johannes Gutenberg-Universität Mainz

A key function of the visual system is to extract behaviorally relevant features of the visual scene. In the visual system, the stable computation of contrast requires two circuit components: a contrast-sensitive pathway that responds to changes in the visual scene and a luminance-sensitive pathway that corrects contrast computation via a fast luminance gain. In *Drosophila*, these two pathways diverge downstream of the same histaminergic photoreceptor input in two first-order interneurons: contrast-sensitive L2 and luminance-sensitive L3 neurons. How these two neurons obtain such fundamentally different properties despite receiving the same input is unknown. Here we show that luminance sensitivity in L3 depends on the transcription factor dFefz, which transcriptionally represses the histamine-gated chloride channel HisCl1. dFefz-mutant L3 neurons display physiological properties resembling those of contrast-sensitive L2 neurons. Using cell-type-specific RNAseq we identified differentially expressed ion channels and receptors in L2 vs L3 which are regulated by dFefz. One of the top candidates was the histamine-gated chloride channel HisCl1. To date, lamina neurons were thought to respond to their photoreceptor input via another histamine-gated chloride channel, Ort. Genetic analysis revealed that HisCl1 is necessary for the elimination of the luminance-sensitive component in L2 neurons. In addition to these distinct cell-autonomous properties of L2 and L3, L2 properties also in part depend on lateral circuitry. A pharmacology-based approach suggests that glutamatergic inhibition mediates the elimination of a luminance-sensitive component in L2 neurons. In summary, our study reveals the cellular and circuit mechanisms underlying the divergent synaptic properties that ultimately achieve behaviorally relevant computations.

Exploring density-dependent desert locust marching with immersive virtual reality

Sercan Sayin¹

¹University of Konstanz, Centre for the Advanced Study of Collective Behaviour, Universitaetsstrasse 10, 78467 Konstanz, Germany

²Max Planck Institute of Animal Behavior, Am Obstberg 1, 78315 Radolfzell, Germany

Collective marching across large distances is an astonishing feat exhibited by larval desert locusts, *Schistocerca gregaria*. Locusts coalesce into groups, called bands, which can further merge into larger collectives. Marching is shown to be dependent on locusts' local density. Danger of cannibalism is also a factor maintaining the collective inertia. However, despite observations in various lab and field studies, local interaction rules, and their translation to collective direction selection, are yet to be mapped. Here, we are utilizing a custom-made immersive virtual reality technology to place a focal locust within a virtual marching band of low-poly realistic locust models. We explore the parameter space of density vs coherence with the aim of finding out the least required conditions to initiate and sustain trajectory alignment. Virtual reality system will additionally allow utilizing neurobiological approaches to explore underlying neural correlates of locust marching in near future.

From skylight to insect eyes: studying the variability in polarisation patterns and the underlying processing to make a robust navigational compass

Athil Althaf Aliyam Veetil Zynudheen¹, James Jonathan Foster¹

¹Neurobiologie, FB Biologie, University of Konstanz, Konstanz, Germany,

Unlike humans, many insects utilise one of the peculiar properties of light, polarisation. The advantage of this polarisation is that it leaves a pattern of polarised light on the sky due to scattering, which insects like honeybees exploit for navigation. They detect this polarised light with the help of specialised ommatidia present in the Dorsal Rim Area (DRA) of their eyes. Even though the polarisation patterns are consistent relative to the sun's position, other factors such as cloud cover, aerosols and other factors affect the skylight polarisation. But honeybees can forage during these conditions, albeit with some difficulties. Recent models incorporate how these polarisation cues are processed and contribute to the celestial compass (Gkaniats et al., 2019). But they take a simpler skylight polarisation as the polarisation input, which is not realistic. In our current project, we are investigating the effects of cloud cover and weather conditions in bee polarisation vision. We compare polarisation images of the sky under different cloud cover conditions, and analyse the aspects of polarisation patterns (degree of polarisation, angle of polarisation, overall luminance) that are conserved and varied during these conditions. Further, by computational approaches, we study how much of this information is received by the honeybees detecting these polarisation inputs from their DRA. This includes studying how the physical and morphological properties of the DRA ommatidia (Stürzl et al., 2010) (arrangement, receptive fields), in turn, affect the polarised light detection. In this way, we aim to modify the current insect polarisation compass models based on the findings.

Heterogeneity of synaptic connectivity in the fly visual system

Jacqueline Cornean¹, Sebastian M. Molina Obando¹, Jonas Chojetzki¹, Lena Heike Lörsch¹, Marion Silies¹

¹Johannes Gutenberg-University Mainz, Institute of Developmental Biology and Neurobiology (iDN), Hanns-Dieter-Hüsich-Weg, 55128 Mainz, Germany

Visual systems are considered homogeneous structures, where highly similar units are organized in columns to retinotopically cover the visual field. The fly eye consists of about 800 single ommatidia and visual columns, with each column encompassing the same neuron types. Each neuron type can be distinguished by its anatomy, by genetic markers, and – in general – by its functional properties, building a clearly structured network. However, there appear to be exceptions to this rule. Although the interneuron Tm9 is clearly identifiable based on its genetic profile and its anatomy, it shows variable properties. In vivo two photon calcium imaging has shown that the spatial receptive field and the temporal properties of Tm9 are highly variable (Ramos-Traslosheros and Silies, 2021). Here we aim to identify the basis of Tm9's heterogeneous physiological properties. Therefore, we examine the anatomical presynaptic connectivity of Tm9 using two methods. Initial EM-based connectomes already suggested a variation of synaptic inputs to Tm9 (Takemura et al. 2013, 2015). Because this study only reconstructed seven visual columns, we set out to identify Tm9 presynaptic partners across the visual field, using the FAFB connectome. To also extend this analysis of variability across fly brains, we used genetic synapse markers in combination with expansion microscopy. This technique allows imaging at nanoscale resolution, enabling superresolution microscopy with conventional light microscopes (Chen et al., 2015). Using this method, we resolved active zones in the adult fly visual system by expressing *brp[short]:mCherry* in Tm9 presynaptic partners, while also marking Tm9 dendrites. Utilizing the proximity of both markers, we can quantify synaptic connectivity, and thereby, Tm9 input variability. Next, we will investigate how these properties transfer to functional connectivity. Given that Tm9 is the main input neuron to T5, the first direction selective cell in the OFF pathway, we ultimately want to study how Tm9 variable features contribute to a robust circuitry.

Implementation of stable contrast computation in the visual circuits

Burak Gür¹, Marion Silies¹

¹Institute of Developmental Biology and Neurobiology, Johannes-Gutenberg University Mainz

A major challenge for the brain is to keep stable neural representations of stimulus features while facing a wide range of sensory inputs. Visual systems handle slow changes in luminance, spanning up to ten orders of magnitude throughout the day, using photoreceptor gain control mechanisms. However, the same mechanisms are not sufficient to accommodate rapid luminance changes encountered when viewing or navigating natural scenes. Thus, a rapid post-receptor luminance gain must be implemented to keep luminance-invariant contrast representations. Here we reveal the visual circuits and mechanisms that implement such rapid post-receptor gain. In the *Drosophila* visual system, the first neurons that exhibit stable contrast representation are the second order interneurons Tm1 and Tm9. These two OFF pathway neurons exhibit a luminance gain that leads to distinct contrast representations, such that Tm1 has luminance-invariant representations, whereas Tm9 boosts the representation of contrasts at low luminance. We show that spatial pooling underlies the luminance gain and accommodates the local differences in luminance within visual scenes. Both neurons receive wide glutamatergic inputs along with their columnar cholinergic inputs. Finally, we reveal that the luminance gain in the two pathways is implemented via distinct molecular mechanisms. Tm9 neurons utilize the glutamate-gated chloride channel GluCl α to implement luminance gain control in its dendrites. Together, our results demonstrate the circuit and biophysical implementation of a novel, rapid gain mechanism vital for dynamic and stable vision in natural scenes. Since visual systems of animals evolved to process similar natural scenes, such mechanisms likely generalize across species.

No direction home: how ants perform systematic searches

Patrick Schultheiss¹

¹University of Würzburg, Behavioural Physiology and Sociobiology, Biocenter, Am Hubland, 97074 Würzburg, Germany

Navigation is of crucial importance for the survival of many animal species. To guarantee the successful completion of a journey, insects engage in highly efficient systematic searches to finally pinpoint their target. The resulting search patterns are highly structured – systematic – while retaining strong adaptive flexibility. Yet, it remains unclear how this sophisticated behaviour is generated by the insect central nervous system. Our current knowledge suggests that it involves the integration of several distinct navigational steering mechanisms in the insect brain. Here, I investigate the extent to which previous visual experience guides ants during their systematic searches for the nest entrance. When experimentally restricting the area around the nest to prevent foraging ants from forming visual memories, I found that subsequent nest searches retained their systematic structure but suffered from very low precision. This indicates that searching ants employ visually guided steering mechanisms, in which the perceived visual environment is matched to visual memories. When such memories are lacking, the steering mechanism is impeded. Further investigations explore the contributions of compass-guided, as well as innate, steering mechanisms to the systematic search. Finally, chemical lesions of targeted brain tissues can provide insights into the neural architecture that generates systematic searches. As a whole, these findings reveal whether highly sophisticated systematic searching behaviour is indeed generated by the interplay of innate movement routines and navigational modules, and how these routines interact with external cues. More broadly, the outcomes allow us to ask questions of fundamental importance about how brains work to produce adaptive behaviour.

Persistent idiosyncratic behavioral traits in *Drosophila melanogaster* depend on individual variability and behavioral context.

Gerit Arne Linneweber¹, Thomas Mathejczyk¹, Cara Knief¹, Muhammad Haidar¹, Mathias Wernet¹

¹FU Berlin, Neurobiology, Koenigin-Luise-Str. 1-3, 14195 Berlin, Germany

Over the last decade, several behavioral studies using insects or other animal models have demonstrated that idiosyncratic behavioral traits remain stable over long time periods. The stability of individually variable traits is often referred to as an animal's individuality or personality. However, all these studies have focused on individual variability in a single behavioral context. Yet it is well established from group-based studies that animal behavior is highly context-dependent. It remains an open question whether individually behavioral traits persist in different behavioral contexts. For instance, an animal might have a strong preference for various visual cues, or only for one particular visual cue, or even only for one visual cue under certain environmental conditions. To investigate this question over a range of behavioral traits, we designed several novel behavioral assays, allowing for automated data acquisition and the analysis of the persistence of behavioral traits under changing environmental contexts like illumination, temperature, and arena shape in both walking and flying *Drosophila melanogaster*. We found that some individually variable behavioral traits persist across different environmental contexts. However, the persistence of behavioral traits varies considerably depending on which specific environmental parameters are modified. While some behavioral traits like the motivation to walk correlate across all tested contexts, parameters like walking speed, angular variability, or handedness persist when altering the temperature and illumination. However, these parameters are strongly altered by changing the arena shape or modality of movement (walking vs. flying). Lastly, we found the persistence or inconsistency of behavioral traits across different contexts to be independent of either genotype or gender.

Responses of central-complex neurons of the desert locust to natural sky presentation

Erich M. Staudacher¹, Keram Pfeiffer^{1,2}, Uwe Homberg¹

¹Philipps-Universität Marburg, Biologie, Tierphysiologie, AG Homberg, Karl-von-Frisch-Str. 8, 35043 Marburg, Germany

²Universität Würzburg, Biozentrum, Zoology II, Am Hubland, 97074 Würzburg, Germany

For navigation, various insects rely on features of the sky, e.g. polarization pattern and spectral gradients. Intracellular recordings have shown that both the angle of polarization and the solar azimuth are encoded by neurons of the locust central complex. In previous studies, relative angles between the strongest response to a zenithal E-vector and the sun azimuth were around 90° for input neurons, but often smaller in output cells (Pegel et al. 2018; JEB 221, jeb171207). Moreover, responses of single neurons to E-vector presentations at various elevations and azimuths corresponded to certain positions of the sun (Zittrell et al. 2020, PNAS 117:25810). These findings indicated that both the solar azimuth and the celestial E-vector pattern can be used for navigation under natural conditions.

We recorded from units in the central brain of the desert locust, *Schistocerca gregaria* (Forskål, 1775) under laboratory and real-world conditions in a garden-shed on top of the Biology Building. All units were exposed to zenithal polarized light in a dark arena within the hut. Here, either the polarizer or the animal were rotated. Afterwards, the animal was rotated under the natural sky. Polarization patterns and spectral characteristics of the natural sky were recorded with a camera and a spectrometer.

Recordings lasted for 1-5 hours, which permitted up to five repeats of each stimulus. Preference angles to polarizer- and animal-rotation inside the hut were highly similar. While the tuning to the azimuthal polarizer (indoors) was always axial, i.e. had a periodicity of 180°, it often changed to a circular tuning with a periodicity of 360° when the animal was exposed to the sky. This indicates a dominance of direct sunlight over sky polarization. In an input unit to the central complex, the angular difference between tuning to polarized light and the solar azimuth in the sky was close to 90°, matching the situation in the sky. In contrast, the angular differences between hut and sky presentations were close to 0°/180° in three output neurons suggesting that sky compass signaling at the input is transformed into a head-direction signal at the output of the central complex. Under the sky, preference angles were mostly circular, i.e. unambiguous, but in some cases remained axial, similar to polarization tuning in the hut. Whenever axial preferences occurred during sky stimulation, brightness in the sky was relatively even and, in most cases, large areas of the sky showed high degrees of polarization. This suggests that the tuning type may change based on the most salient feature of the sky. During a 5-h recording of a presumed output unit, the preference angles to the polarizer inside the hut and in response to the real sky remained relatively stable despite a considerable change in solar azimuth. The preference angle of an output unit most likely represents heading direction. To keep it stable, a time-compensation mechanism with input from the circadian clock of the animal would be required.

Six populations of local motion detectors represent optic flow generated during flight

Miriam Henning¹, Azize Karakut², Burak Gür¹, Joachim Urban², Marion Silies¹

¹ Institute of Developmental Biology and Neurobiology (iDN) Neural Circuits lab, Johannes-Gutenberg-Universität Mainz, Hanns-Dieter-Hüscher-Weg 15, 55128 Mainz, Germany

² Institute of Developmental Biology and Neurobiology (iDN) Neural Genetics lab, Johannes-Gutenberg-Universität Mainz, Hanns-Dieter-Hüscher-Weg 15, 55128 Mainz, Germany

Optic flow patterns generated on the eye during self-motion are essential for navigation. Different types of self-movements create unique motion patterns that need to be encoded by the brain. Therefore, the brain first needs to extract local motion cues, corresponding to spatiotemporal changes in luminance, and transform these local motion vectors into a global pattern of visual motion. In the mouse retina, four types of global optic flow patterns are encoded by four populations of local direction-selective cells (Sabbah et al., 2017). Whereas in the fruit fly (*Drosophila*), four types of local direction-selective T4/T5 cells are thought to be uniformly tuned to the cardinal directions of motion (Maisak et al., 2013; Fisher et al., 2015). But it is still unclear how complex global motion patterns, represented downstream by large wide field cells could be computed. To understand how global motion is represented by the population of T4 and T5 cells, we used in vivo two-photon calcium imaging to characterize the direction tuning of T4/T5 cells across visual space. We show that like the mouse retina, the population of T4/T5 cells are not uniformly tuned but encode global motion patterns (Henning et al., 2022). Instead of four, we find six functional subtypes that represent different types of self-motion encountered during flight. These six subtypes project their axons into four anatomical layers of the lobula plate, where the first two layers house two subtypes each. The increased complexity of flow fields represented by six subtypes of motion detectors in flies might highlight an adaptation to the modes of the animal's behavior. We are currently further investigating the genetic identity and the developmental origin of the six T4/T5 subtypes. Together this work will help to understand how ethological constraints shape the development, anatomy, and function of neuronal networks.

Temperature effects on wide-field motion sensitive neurons in the central brain of bumblebees

Bianca Jaske¹, Keram Pfeiffer¹

¹Department of Behavioral Physiology and Sociobiology, Biocenter, University of Würzburg, Würzburg, Germany

Moving animals experience wide-field motion due to the displacement of the retinal image. These cues provide information about rotatory and translational self-motion (Gibson, 1950, *Am. J. Psychol.*) and allow to estimate different parameters like flight speed (David, 1982, *J. Comp. Physiol. A*) or distance (Esch and Burns, 1995, *Naturwissenschaften*), but are also involved in more complex tasks like path integration (Stone et al., 2017, *Curr. Biol.*). Honeybees and bumblebees are capable of regulating their body temperature above the ambient temperature by shivering thermogenesis (Stabentheiner et al., 2003, *J. Exp. Biol.*), i.e. they actively produce heat by vibrating their flight muscles (Heinrich, 1973, *Science*). Nevertheless, most studies describe neuronal properties of insect neurons at room temperature. Because temperature influences biochemical processes (Montgomery and Macdonald, 1990, *Am. J. Physiol. Regul. Integr. Comp. Physiol.*) neuronal response properties are affected by temperature as well. For example, photoreceptors of the blowfly respond faster at higher temperatures (Tatler et al., 2000, *J. Comp. Physiol. A*). Also, the response of an interneuron of blowflies is faster for higher temperatures and additionally increases in mean spike rate (Warzecha et al., 1999, *J. Exp. Biol.*). To understand how temperature affects tuning properties of wide-field motion sensitive neurons we recorded extracellularly in the central brain of tethered bumblebees while controlling the head temperature of the animal. We compared neuronal responses to moving stripe patterns at different spatial and temporal frequencies for two different temperature conditions: 24 °C and 32 °C. Four different response types were observed. Most units responded with an increase in response amplitude and a shift of preferred temporal frequency to higher values for the warmer temperature condition. For two further response types, a temperature increase affects neuronal responses to increase either only in response amplitude or only in preferred temporal frequency. Additionally, some units only showed a response for the high temperature condition and did not respond at room temperature at all. Most likely, units of these four response types represent neuronal activity of cells from the medulla and the lobula crossing the mid brain, indicating a behavioural relevance for controlling and stabilizing self-motion. If a bumblebee actively increases its forward velocity visual cues need to get resolved faster. Furthermore, an increased forward velocity would lead to an increase in head temperature due to higher muscle activity. Hence, the need to resolve visual cues faster for increasing forward movement might be solved due to higher sensitivity of neuronal responses caused by an increase in head temperature.

The cockroach central complex: Physiology and morphology of single neurons in the brain of *Rhyparobia maderae*

Stefanie Jahn¹, Vanessa Althaus¹, Naomi Takahashi¹, Juliana Schott¹, Mona Janning¹,
Uwe Homberg¹

¹Philipps-Universität Marburg, Tierphysiologie, Karl-von-Frisch-Str. 8, 35043 Marburg, Germany

As navigation is an essential ability for animals to find mating partners, new food sources or a way back home, research on navigational mechanisms in the brain is of great significance. Many insects are able to use celestial cues like the polarization pattern of the sky or the position of the sun to navigate in familiar or unknown environments. While most model insects like the monarch butterfly *Danaus plexippus* or the desert locust *Schistocerca gregaria* are diurnal insects, we focused on the nocturnal cockroach *Rhyparobia maderae* that relies considerably on antennal information for spatial explorations. The central complex in the insect brain plays a major role in navigation and motor control and is composed of the protocerebral bridge (PB), the upper and lower divisions of the central body (CBU and CBL) and the paired noduli (NO).

After implementing a 3D atlas of the brain of *Rhyparobia maderae* (Althaus et al. 2022, J. Comp. Neurol.) we categorized neuronal types of cockroach central complex and investigated their ability to process various types of visual information. To reveal differences or similarities in the processing of navigational information in the cockroach central complex with that of other insects we used dye-filled neurons, immunostainings and intracellular recordings from tethered cockroaches.

The cockroach central complex differs in several respects from that in other species. The diversity of columnar neurons and their ramification areas are unique compared to other insects studied. Several columnar neurons with ramifications in PB or CBU also arborize in the CBL whose composition differs from that in *S. gregaria* or *Drosophila melanogaster* as it consists of a combination of eight cone- and nine tooth-like compartments. Many CX neurons arborize in a large neuropil anterior to the CB, the anterior lip, that is not present in holometabolous species. Furthermore, the most prominent input and output area of the CX, the lateral complex (LX) is divided into subcompartments that often house the ramifications of only one type of CX neuron. Intracellular recordings revealed that five types of central complex neurons respond significantly to a zenithal polarized light source or a simulated solar azimuth. In other recordings, those neuron types were insensitive to the presented stimuli. The data, therefore, show stronger state dependent suppression of sensitivity to sky compass signals than in other species and reveal anatomical specialties that might be related to a nocturnal lifestyle.

The dynamic properties of sky-compass neurons in bumblebees during naturalistic stimulation

Lisa Rother¹, Keram Pfeiffer¹

¹ Department of Behavioral Physiology & Sociobiology, Biocenter, University of Würzburg, Germany

Bumblebees show astonishing orientation abilities during foraging trips or homing, using celestial cues like the polarization pattern of the sky. Polarization information is processed in the sky-compass pathway and provides a reference for compass neurons in the central complex (CX). Contrary to common belief, bumblebees are excellent fliers that perform highly dynamic flight maneuvers. Flying bumblebees typically perform rapid saccadic yaw turns, at angular velocities of up to 2000°/s, alternating with translational flight (Boedekker et al. 2015). This behavior creates a highly dynamic visual input into the sky-compass system in the CX. Traditionally in electrophysiological experiments, targeting sky-compass neurons, the tuning of such neurons has been characterized with respect to simulated skylight cues that rotate at a slow, constant velocity of 30 to 60 °/s. This kind of stimulus, however, is fundamentally different from the polarized light information that a bumblebee perceives during its highly dynamic flight.

Here, we recorded intracellularly from compass neurons in the CX of bumblebees, while presenting a naturalistic polarized light stimulus. To simulate the stimulus dynamics a bumblebee experiences during flight, we used a linear polarizer, that was backlit by a UV LED (365 nm), and rotated according to head orientations obtained from freely flying bumblebees (Boedekker et al. 2015).

Despite the high rotational velocities, we found consistent spiking patterns of CX-neurons during repeated presentation of the stimulus, showing that the neurons were reliably encoding the stimulus. We also noticed that the presentation of identical angles of polarization sometimes leads to strong excitation, but also to inhibition. This suggests that additional mechanisms influence the neuronal responses. However, post-stimulus effects, like post-excitatory inhibition and post-inhibitory rebound excitation could play a role in shaping these asymmetric activity levels. To better understand the reactions to the naturalistic stimuli, we designed a rate-code model of neuronal activity that implemented the neuronal response to the angle of polarization both as a function of the current stimulus and the spiking history. The latter part was calculated as the inverse of the average preceding activity. Fitting the model to our recorded data showed that the inclusion of spiking history always improved the fit. Because the firing rates of the neurons depended both on the current stimulus, and on the spiking history, it is not possible to extract the current heading from an individual neuron. However, by modelling a population of neurons, each with a different preferred angle of polarization, we are able to show that this population can encode the correct angle of polarization. In this population code, the inclusion of spiking history into the model allows for faster signaling of a new heading direction after a turn.

Supported by DFG Grant PF714/5-1.

Walking bumblebees see faster

Keram Pfeiffer¹, Robin Müller¹, Erwin Kirschenmann¹, Markus Thamm¹, Lisa Rother¹

¹University of Würzburg, Behavioral Physiology and Sociobiology, Am Hubland, 97074 Würzburg, Germany

The behavioral state of an animal is a major factor that modulates neuronal processing. In insects, this has been documented in the visual system of flies, where motion sensitive neurons increase their gain, when the animals move their halteres (Rosner et al. 2010), walk (Chiappe et al. 2010) or fly (Maimon et al. 2010). However, it is unknown if state-dependent changes in processing also occur at the receptor level.

To test this, we recorded electroretinograms (ERGs) from the compound eye of tethered bumblebees, that were either sitting, or walking on an air-supported Styrofoam ball. We recorded differentially from both compound eyes while stimulating one of them with the light of a green LED (530 nm). The intensity of the LED was controlled by a current source that was driven using Gaussian white noise. This allowed us to continuously extract the response speed of the ERG by calculating the cross-correlation between the stimulus and the ERG.

We found that the time lag between the stimulus and the response dropped from 9.0 ± 0.75 ms in sitting animals to 7.4 ± 1.0 ms in walking animals. We also calculated the linear coherence between the two signals, which measures the similarity in frequency content. We found that the coherence function was slightly shifted to higher frequencies in walking animals.

Using a thermographic camera, we were able to show that the changes in processing speed during walking coincide with an increased temperature of the eye, which warms up due to heat produced in the thorax. We therefore asked if temperature changes alone are sufficient to explain the effects we observed. To answer this question, we repeated our experiments on animals that were sitting, but were heated by an infrared lamp. We found that external heating of the bumblebees could reproduce the results obtained from walking animals. Furthermore, heating to higher temperatures of up to 37°C, as they occur during flight, showed that the time lag becomes even shorter and that the coherence shows a stronger shift towards higher frequencies. We conclude, that heat produced in the thorax during walking increases the processing speed in the visual system and that this change might be advantageous to cope with the higher information rates that are perceived during locomotion.

Supported by DFG Grant PF714/5-1

Poster Topic

T15: Vision: Retina and Subcortical Pathways

- [T15-1A](#) Analysis of the receptive field substructure of retinal ganglion cells with artificial neural networks
Margaret Young, Tim Gollisch
- [T15-2A](#) Complexin 3 and 4 play a major role in retinal dark and light adaptation in mice: an electroretinographic study
Nina Martina Stallwitz, Anneka Joachimsthaler, Jan Kremers
- [T15-3A](#) Connectivity of photoreceptors and bipolar cells in two avian retinas
Anja Günther, Paul Watkins, Karin Dedek, Silke Haverkamp, Stephan Irsen, Henrik Mouritsen, Kevin Briggman
- [T15-4A](#) Does Bassoon maintain cone photoreceptor survival by regulating retinal homeostasis?
Miriam Ryl, Enes Yagiz Akdas, Sophia Bayer, Kaspar Gierke, Julia von Wittgenstein, Anna Fejtová, Johann Helmut Brandstätter
- [T15-5A](#) Feature selectivity of collicular wide-field neurons is generated by stratified inputs and nonlinear dendritic filtering
Norma Kühn, Chen Li, Bram Nuttin, Natalia Baimacheva, Arnau Sans Dublanc, Katja Reinhard, Vincent Bonin, Karl Farrow
- [T15-1B](#) Horizontal cells in different avian species
Vaishnavi Balaji, Henrik Mouritsen, Karin Dedek
- [T15-2B](#) Individual inhibitory interneurons in the thalamus are functionally specialized towards distinct visual features
Fiona Elisabeth Müllner, Botond Roska
- [T15-3B](#) Inference of Functional Network Structure using Matrix Factorization
Sören J. Zapp, Tim Gollisch
- [T15-4B](#) Inferring mechanisms of visual signal processing in the vertebrate retina using biologically inspired CNNs
Shashwat Sridhar, Michaela Vystrčilová, Alexander Ecker, Tim Gollisch
- [T15-5B](#) Interrogating a putative circuit in the inner retina
Juan Diego Prieto, Tim Gollisch

- [T15-6B](#) Model-based analysis of temporal adaptation in responses of retinal ganglion cells to spatiotemporal stimulation
Robert Mihai Haret, Tim Gollisch
- [T15-1C](#) Neural basis of visual information integration and decision-making
Katja Slangewal, Max Capelle, Florian Kämpf, Armin Bahl
- [T15-2C](#) Protein Interaction Network of the Complexin 4 - SNARE Complex in the Retina
Jutta Meyer, Uwe Lux, Olaf Jahn, Nils Brose, Johann Helmut Brandstätter, Kerstin Reim
- [T15-3C](#) Response properties of suppressed-by-contrast cells in the early mouse visual system
Florentyna Debinski, Simon Renner, Emma Müller-Seydlitz, Yuyang Huang, Timm Schubert, Laura Busse, Thomas Euler
- [T15-4C](#) Super-resolution imaging in the mouse retina
Timm Schubert, Kseniia Sarieva, Leon Kremers, Thomas Euler
- [T15-5C](#) Towards a light-mediated gene therapy for the eye - retinal transgene expression through photoactivation of caged Tamoxifen and the inducible Cre/lox system
Sidney Cambridge
- [T15-6C](#) Visual encoding by retinal ganglion cells in optogenetic models for vision restoration
Varsha Ramakrishna, Tim Gollisch, Sonja Kleinlogel

Analysis of the receptive field substructure of retinal ganglion cells with artificial neural networks

Margaret Young^{1,2,3}, Tim Gollisch^{1,2}

¹Universitätsmedizin Göttingen, Klinik für Augenheilkunde AG Retina, Waldweg 33, 37073 Göttingen, Germany

²Bernstein Center for Computational Neuroscience Göttingen, 37077 Göttingen, Germany

³International Max Planck Research School for Neuroscience, 37077 Göttingen, Germany

A central question in sensory neuroscience asks how neural circuits perform complex computations across cascaded cell layers to faithfully encode complex stimuli. Specifically in the retina, retinal ganglion cells already extract salient features of the visual scene, such as texture and motion. This occurs in part through the nonlinear integration at the ganglion cell of inputs across an array of bipolar cells. The characteristics of such signal integration determine the ganglion cell's response to various visual stimuli and the cell's overall computational role in early visual processing.

Thus, developing computational analyses that can model retinal ganglion cell responses to various visual stimuli and emulate nonlinear spatial integration are highly desirable. Of particular interest have been models that structure the ganglion cell's receptive field into subunits, where each subunit is thought to reflect input from individual bipolar cells. These models have emerged to better reflect relevant aspects of retinal circuitry and capture stimulus encoding, especially compared to traditional approaches that use the receptive field to filter the stimulus. Attention has recently turned to artificial neural networks, which have already shown promise in predicting retinal responses to natural scenes and in inferring bipolar cell properties from retinal ganglion cell responses to visual stimuli. However, none of these network models have explicitly sought to extract ganglion cell subunits from two-dimensional visual stimuli.

Here, we introduce two neural network models for detecting the layout of subunits within the receptive fields of retinal ganglion cells: a neural network that seeks to predict spikes given a visual stimulus and an autoencoder. When applied to previously recorded data from ganglion cells in the salamander retina stimulated with spatiotemporal white noise, both of our neural network models can retrieve the layout of subunits within the ganglion cell's receptive field. Not only do the subunits fully tile the ganglion cell's receptive field, but specific subunits also arise from neural networks with different numbers of hidden units, emphasizing our model's biological feasibility. The identified subunit layouts allow improved predictions of ganglion cell responses to held-out white noise images compared to linear models. These models are also further compared with other methods of subunit identification.

Ultimately, these models can facilitate the development of detailed stimulus-response models for ganglion cells that are capable of mapping onto retinal circuits, thus helping elucidate how these complex computations arise from sensory circuits.

Complexin 3 and 4 play a major role in retinal dark and light adaptation in mice: an electroretinographic study

Nina Martina Stallwitz^{1,2}, Anneka Joachimsthaler^{1,2}, Jan Kremers¹

¹University Hospital Erlangen, Eye Clinic, Section for Retinal Physiology, Schwabachanlage 6, 91054 Erlangen, Germany

²Friedrich-Alexander-Universität Erlangen-Nürnberg, Department Biologie, Lehrstuhl Tierphysiologie/Neurobiologie, Staudtstraße 5, 91058 Erlangen, Germany

Purpose: Complexins (Cplx) regulate the speed and Ca²⁺-sensitivity of SNARE-mediated synaptic vesicle fusion. Cplx are found in the mouse retina mainly in rod (Cplx 4) and cone (Cplx 3 and 4) photoreceptor cell ribbon synapses and in bipolar cell ribbon synapses (Cplx 3 and 4). To analyze the functional role of Cplx in dark and light adaptation processes, flicker electroretinographic (ERG) recordings were done on Cplx 3/Cplx 4 double-knockout (DKO) mice.

Methods: After dark adapting animals overnight, all handling was done under dim red light to maintain dark adaptation. Animals were anaesthetized with a mixture of 50:10 mg/kg ketamine/xylazine. Two protocols, one to study dark adaptation (DA) and one to investigate light adaptation (LA), were employed to measure ERGs in two separate groups of Cplx 3/Cplx 4 DKO mice and WT littermates. In both protocols, 8Hz sinusoidal 100% contrast luminance modulation was used as stimulation and an initial baseline (BL) measurement at 0.4 cd/m² mean luminance (ML) was performed. For the DA protocol the light was subsequently increased to 8.8 cd/m² ML for 10 min to light adapt the retina. Thereafter, the ML was decreased back to 0.4 cd/m² ML to investigate DA for the following 35 min. Throughout this procedure, ERGs were recorded repeatedly with 2 min intervals. For the LA protocol, the luminance was increased to 260 cd/m² ML after three BL measurements with 5 min intervals. During LA ERGs were recorded repeatedly for 44 min with 1 min intervals for first 10 min and 2 min intervals for the rest of the measurement. The MLs of the stimuli were identical to the MLs of the non modulating background in the intervals between the recordings.

ERG amplitudes were defined as the amplitudes of the 1st harmonic components after Fourier analysis of the recordings.

Results: The BL measurements of the DA and LA protocol showed reduced amplitudes for DKO animals in comparison to WT mice.

DA protocol: Directly after luminance increase to 8.8 cd/m², ERG amplitudes measured in DKO and WT animals decreased to the same amplitude close to noise level. After luminance decrease to 0.4 cd/m², amplitudes of both genotypes diverge: Responses of both WT and DKO mice increased over time. The increase could be described by an inverse exponential function. However, responses of DKO mice were generally a factor of about 3 smaller than those measured in WT mice.

LA protocol: At light increase, ERG amplitudes initially decreased evenly strong about 50% in DKO and WT mice. Thereafter, WT animal amplitudes further decreased about 25% according to an inverse exponential function. In contrast, ERG amplitudes in DKO animals increased in the first 10 min of light after which amplitudes decreased again. The decrease could be described by an inverse exponential function. DKO mice amplitudes were always smaller than WT mice amplitudes, but after 35 minutes responses in WT were only slightly larger than the responses in DKO mice and a factor 2 above noise level.

Conclusions: i) Complexins play a major role in DA and LA processes in the mouse retina, ii) Rod-driven recordings show strongly reduced amplitudes in DKO animals and may demonstrate the involvement of Cplx 4 for dark adaptation – as rods only express Cplx 4. iii) The significantly contrary course of cone-driven

ERGs in DKO and WT amplitudes in the first 10 min and the different courses of the subsequent amplitude decrease during LA suggest a complex involvement of Cplx3 and 4 in cones.

Connectivity of photoreceptors and bipolar cells in two avian retinas

Anja Günther¹, Paul Watkins¹, Karin Dedek^{2,3}, Silke Haverkamp¹, Stephan Irsen⁴, Henrik Mouritsen^{2,3}, Kevin Briggman¹

¹Max-Planck-Institute for Neurobiology of Behavior – caesar, Computational Neuroethology, 53175 Bonn, Germany

²Carl von Ossietzky University of Oldenburg, Neurosensorics/Animal Navigation, Institute for Biology and Environmental Sciences, 26129 Oldenburg, Germany

³Carl von Ossietzky University of Oldenburg, Research Center for Neurosensory Sciences, 26129 Oldenburg, Germany

⁴Max-Planck-Institute for Neurobiology of Behavior – caesar, Electron Microscopy and Analytics, 53175 Bonn, Germany

Birds are highly visual animals but how visual information is processed within the avian retina is enigmatic. To better understand the function of individual cell types and distinguish species-specific retinal circuits from generalized circuits, it is crucial to characterise and analyse the connectivity within different avian retinas. Here we use serial sectioning multi-beam SEM to investigate the outer plexiform layer (OPL) connectivity within the chicken (Günther et al., 2021, JNeurosci) and European robin retina and are in the process of comparing the photoreceptor-photoreceptor and photoreceptor-bipolar cell connectivity between the two species. Our preliminary analysis has revealed that, in contrast to the chicken retina in which all bipolar cell types are bistratified or multistratified, several bipolar cell types in the European robin retina are also monostatified. We also observed unusual axonal or dendritic loops in the inner nuclear layer that were only found in specific bipolar cell types of the European robin retina. Additionally, we were able to identify specific bipolar cells contacting only one type of single cone. Our data from both species indicate a complex synaptic connectivity already in the OPL of the avian retina.

Does Bassoon maintain cone photoreceptor survival by regulating retinal homeostasis?

Miriam Ryl¹, Enes Yagiz Akdas², Sophia Bayer¹, Kaspar Gierke¹, Julia von Wittgenstein³,
Anna Fejtová², Johann Helmut Brandstätter¹

¹Friedrich-Alexander-Universität Erlangen-Nürnberg, Department of Biology, Animal Physiology/Neurobiology, Germany

²University Hospital Erlangen, Department of Psychiatry and Psychotherapy, Germany

³Friedrich-Alexander-Universität Erlangen-Nürnberg, Emil Fischer Center, Institute of Biochemistry, Germany

The presynaptic scaffolding protein bassoon (BSN) is an important component of the active zone of chemical synapses, where it contributes to synapse formation and function. In addition, BSN plays a special role as an anchor for the synaptic ribbon in photoreceptor cells. Recent studies have revealed novel functions of BSN in autophagy and proteasomal degradation in mouse brain neurons. This is interesting because we have found degeneration of cone photoreceptors and remodeling of the outer retina in two BSN-deficient mouse lines, *Bsn* ^{Δ Ex4/5} and *Bsn*^{gt}. In contrast, we did not detect such a retinal phenotype in a third BSN-deficient mouse line, *Bsn*^{ko}. This raises the questions of (i) whether BSN is involved in the control of homeostasis pathways in photoreceptor cells that are important for the survival of these highly active sensory neurons, and (ii) which of the three studied BSN-deficient mouse lines reveals the synaptic function of BSN.

Our results show that proteasomal degradation and autophagy are increased in the retina of both *Bsn*^{gt/gt} and *Bsn*^{ko/ko} mice. Therefore, altered cellular homeostasis is not sufficient to initiate cone photoreceptor degeneration and outer retina remodeling in *Bsn*^{gt/gt}. We hypothesize that an additional trigger is required to cause cone photoreceptor degeneration. Interestingly, crossbreeding experiments between *Bsn*^{gt} and *Bsn*^{ko} mice have shown a mild retinal phenotype in *Bsn*^{gt/ko} mice. We therefore suggest that a residual N-terminal BSN fragment in *Bsn*^{gt} mice could be the final trigger for cone degeneration. Recent overexpression experiments of this hypothetical N-terminal BSN fragment in HEK293 cells have shown its accumulation at the Golgi apparatus and increased proteasomal activity.

Thus, a residual BSN fragment in cone photoreceptors of *Bsn*^{gt/gt} mice could lead to sufficient cell stress to initiate degeneration. Currently, we investigate if such an N-terminal BSN fragment is present in the retina of *Bsn*^{gt/gt} mice.

Feature selectivity of collicular wide-field neurons is generated by stratified inputs and nonlinear dendritic filtering

Norma Kühn¹, Chen Li², Bram Nuttin¹, Natalia Baimacheva^{1,3}, Arnau Sans Dublanc¹,
Katja Reinhard^{1,4}, Vincent Bonin¹, Karl Farrow¹

¹NERF, KU Leuven, Kapeldreef 75, Leuven, Belgium.

²Department of Neuroscience, Yale School of Medicine, New Haven, CT, USA.

³ITMO University, Saint Petersburg, Russia.

⁴Sissa, Trieste, Italy.

The rules by which neurons combine their inputs to generate the appropriate output are key to brain function. While we know about the computational power of dendrites, how they help to filter sensory information to produce a neuron's output and drive behavior is underexplored due to the inability to trace inputs back to their sensory origin. Here, we address this problem using wide-field (WF) neurons of the mouse superior colliculus; a genetically targetable cell-type that receives direct input from the retina and mediates innate orienting behaviors. To understand how WF neurons combine their inputs, we use a combination of viral tracing and two-photon imaging to measure the visual responses in the dendrites and cell-bodies of WF neurons, as well as from their retinal inputs and local inhibitory inputs. Linear mapping of the retinal and inhibitory signals along the dendrites of WF neurons reveals distinct layers where specific inputs arrive. While a linear model fails to reconstruct the responses of WF cell-bodies, a non-linear model with at least two input layers accounts for the identified input structure and adequately reconstructs the cell-body responses.

Our findings suggest that WF neuron dendrites have the capability to nonlinearly filter specific feature combinations from their diverse stratified inputs. To which extent each retinal cell-type contributes to WF signaling, remains to be uncovered by targeted manipulation thereof. Here, we established WF neurons as a unique model system to study the role of dendritic processing on the filtering of sensory information and its impact on behavior.

Horizontal cells in different avian species

Vaishnavi Balaji¹, Henrik Mouritsen¹, Karin Dedek¹

¹Neurosensory Sciences/Animal Navigation, Institute for Biology and Environmental Sciences, Carl von Ossietzky University of Oldenburg, 26129 Oldenburg, Germany

Migratory birds, like the European robin (*Erithacus rubecula*) are able to detect the Earth's magnetic field in order to navigate to their wintering/breeding sites. The mechanism behind this magnetic compass sense presumably resides in the retina of migratory birds. It is light-dependent and likely involves radical-pair forming cryptochrome molecules whose isoforms are differentially expressed in avian photoreceptors: red cones and double cones express cryptochrome 4¹, the most likely magnetosensor molecule², and UV cones express cryptochrome 1a^{3,4}. Horizontal cells are postsynaptic to photoreceptors and provide feedback signals to photoreceptors and feedforward signals to bipolar cells, thereby contributing to gain control, contrast enhancement, colour opponency, and potentially the processing of magnetic information. Here, we investigated horizontal cells in different bird species and aimed to identify the number of horizontal cell types, based on their immunohistochemical profile and photoreceptor connectivity.

We used several immunohistochemical markers to label the different types of horizontal cells, analyzed the peripheral and the central European robin retina and compared it to the chicken (*Gallus gallus domesticus*). Additionally, individual horizontal cells were targeted in vibratome sections and filled with fluorescent dyes to study their photoreceptor connections.

While four different types of horizontal cells were described in the chicken⁵, our preliminary data show only three different types of horizontal cells in the European robin retina. In both avian species, however, two types of horizontal cells were particularly abundant: 1. an axon-bearing type (HC1) contacting all cone types, positive for calretinin and GABA but negative for Islet1, and 2. an axon-less type with "candelabrum-like" dendrites (HC2) exclusively contacting double cones. This cell type corresponds likely to calretinin-negative but Islet1-positive cells. We did not find clear differences between peripheral and central retinas (apart from striking differences in cell densities).

Overall, the horizontal cell types and connectivity are similar between migratory (European robin) and non-migratory species (chicken). Double cone-selective HC2 cells may carry magnetic information, whereas the HC1 type may sample from many different cones. If HC1 provided mixed inputs to cone-selective bipolar cells, the combination of selective (bipolar cells) and non-selective (HC1) sampling could yield an antagonistic pathway for magnetic signals and/or colour information, comparable to colour-opponent circuits in the peripheral retina of primates⁶. Further studies are needed to shed light on the complex neuronal connections in the outer retina of birds.

References

- 1 A. Günther et al., *Curr Biol*, 28(2):211-223.e4 (2018)
- 2 J. Xu et al., *Nature*, 594:535-540 (2021)
- 3 C. Niessner et al., *PLOS ONE* 6, e20091 (2011)
- 4 P. Bolte et al., *Ethol Ecol Evol*, 33:248–272 (2021)
- 5 A.J. Fischer et al., *J Comp Neurol*, 500:1154-1171 (2007)
- 6 G.D. Field GD et al. *Nature*, 467:673–677 (2010)

Individual inhibitory interneurons in the thalamus are functionally specialized towards distinct visual features

Fiona Elisabeth Müllner¹, Botond Roska¹

¹Institute of Molecular and Clinical Ophthalmology Basel (IOB), Switzerland

Inhibitory interneurons in the dorsolateral geniculate nucleus (dLGN) are situated at the first central synapse of the image forming pathway. Yet, little is known about their function. Here, using targeted single-cell initiated rabies tracing, we found that mouse dLGN interneurons exhibit a similar degree of presynaptic input specialization as thalamocortical neurons. However, the specialization of interneurons is complementary to that of thalamocortical neurons, displaying a preference for transient information, including direction-selective inputs. Two photon calcium imaging performed *in vivo* revealed that the distribution of interneuron direction selectivity indices matches the distribution of direction-selective inputs they receive from retina. Furthermore, in mice lacking retinal horizontal direction selectivity, horizontal direction selectivity is significantly reduced in interneurons, confirming a causal link between their anatomical and their functional specialization. Functional specialization is not only present at interneuron somata but extends into their dendrites. Altogether, each individual inhibitory interneuron globally encodes one visual feature that originates largely in the retina.

Inference of Functional Network Structure using Matrix Factorization

Sören J. Zapp^{1,2}, Tim Gollisch^{1,2}

¹University Medical Center Göttingen, Department of Ophthalmology, Göttingen, Germany

²Bernstein Center for Computational Neuroscience, Göttingen, Germany

Neurons are driven by the inputs of multiple presynaptic cells. These may form functional subunits within the receptive fields of sensory neurons. Due to technical limitations, these subunits are experimentally largely inaccessible and form a hidden layer within the network. Various computational techniques are being developed to infer the subunits in this hidden layer from the input and output of the network. These include, on the one hand, convolutional neural network models that are trained in a supervised manner to precisely fit the output to the input. These are, however, not guaranteed to faithfully describe the original network and are subject to a predefined architecture. Clustering techniques, on the other hand, uniquely group the outputs by properties of their input. Both of these approaches are computationally demanding and time consuming. Inspired by spike-triggered nonnegative matrix factorization (STNMF) (Liu et al., 2017), we explore matrix factorization with different constraints like non-negativity, orthogonality and sparsity to minimize assumptions on the biological system and the number of hyper-parameters. We show that localized subunits emerge naturally from the data without any locality constraints. Unlike other methods, the number of subunits is not specified beforehand but arises automatically. The algorithm abstains from complex calculations allowing for efficient computation. With a recovery of subunits within a few seconds per receptive field, the algorithm surpasses other approaches in computational speed (e.g. at least 100 times faster than the original STNMF) and provides a viable application to large populations of cells. We demonstrate that the method successfully recovers localized subunits that tile the receptive field of populations of retinal ganglion cells in mice, salamanders and marmosets.

Liu, J. K., Schreyer, H. M., Onken, A., Rozenblit, F., Khani, M. H., Krishnamoorthy, V., Panzeri S., Gollisch, T. (2017). Inference of neuronal functional circuitry with spike-triggered non-negative matrix factorization. *Nature Communications* 8, 149.

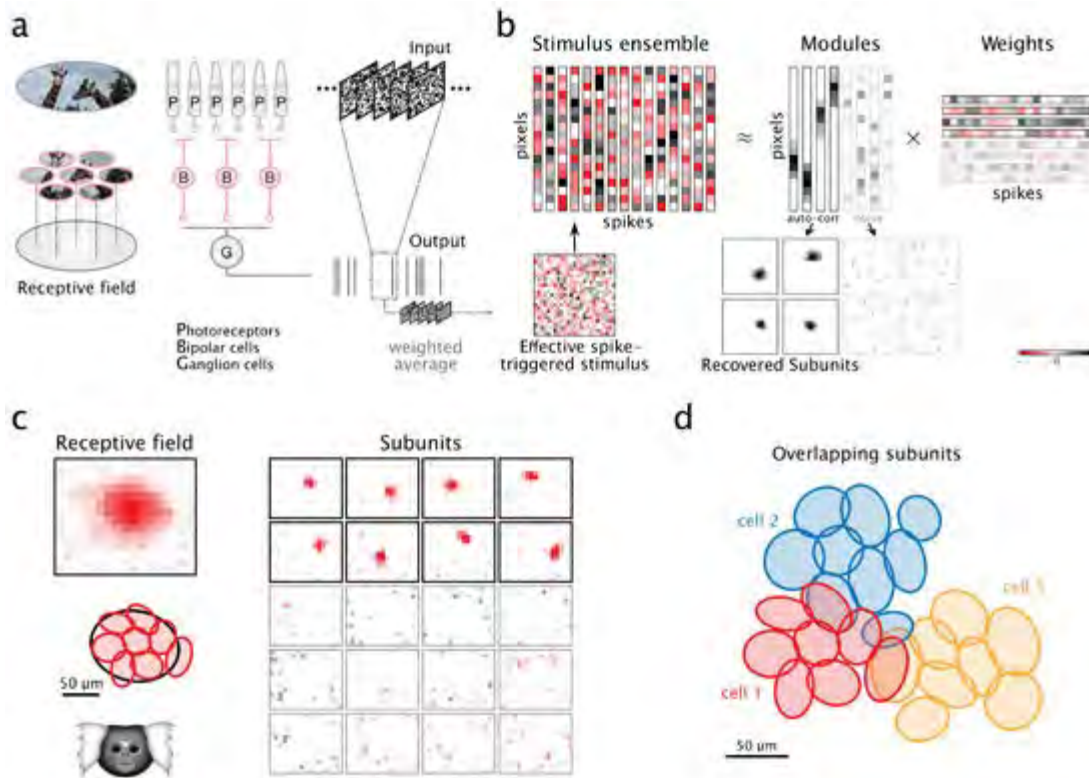

Subunit recovery (a) Stimuli and spikes, the input and output of a network, construct a matrix (b) to be factorized into subunits. (c) Example receptive field of a retinal ganglion cell of a marmoset with the recovered subunits. (d) The method finds overlapping subunits across multiple cells of the same recording.

Inferring mechanisms of visual signal processing in the vertebrate retina using biologically inspired CNNs

Shashwat Sridhar¹, Michaela Vystrcilová², Alexander Ecker^{2,3}, Tim Gollisch^{1,3}

¹Department of Ophthalmology, University Medical Center, Göttingen, Germany

²Department of Computer Science, University of Göttingen, Germany

³Bernstein Center for Computational Neuroscience, Berlin, Germany

Standard models of signal processing in the retina, such as the Linear-Nonlinear (LN) model, strike a good balance between simplicity and predictive power. However, due to their strong assumptions of linearity in the integration of spatial and temporal information, they fail to sufficiently explain the responses of many retinal ganglion cells (RGCs). Newer models may improve prediction performance and yield greater insights into the mechanisms underlying visual signal processing, as in the Spatial Contrast (SC) model, which modifies the LN model by introducing non-linear processing steps that mimic the computation of the local mean intensity and contrast. Another independent family of models are Convolutional Neural Networks (CNNs), the current implementations of which provide significantly better prediction performance at the steep cost of opacity. An ideal model would then have the desirable properties of both these families of models - high prediction performance and a transparent underlying mechanism.

In this work, we take a step in that direction by developing a biologically realistic CNN that borrows its architecture from the anatomy of the retina. Such design constraints make the model less opaque and allow for the inference of the functions of hidden cell layers in the retina. We train this model on RGC responses to spatiotemporal white noise and natural movies, recorded from salamander, mouse and marmoset retinas using microelectrode arrays. We compare its performance to the SC model and examine the differences in what they are sensitive to.

Interrogating a putative circuit in the inner retina

Juan Diego Prieto^{1,3,4}, Tim Gollisch^{1,2,3,4}

¹Department of Ophthalmology, University Medical Center Göttingen, Waldweg 33, 37073 Göttingen, Germany

²Bernstein Center for Computational Neuroscience, Göttingen, Germany

³International Max-Planck Research School for Neurosciences, Göttingen, Germany

⁴SFB 889 Cellular Mechanisms of Sensory Processing, Göttingen, Germany

Saccades are short, fast eye movements that continuously interrupt the flow of visual information, and they have been shown to modulate activity from ganglion cells of the retina (RGCs). Previous work on the mouse described image-recurrence sensitive (IRS) RGCs that display increased spiking frequency in response to the recurrence of images across brief transitions in the context of saccade-like visual stimulation. The lack of adaptation to the stimulus runs counter to classical explanations of how RGCs integrate inputs, but the synaptic mechanisms underlying IRS responses remain unknown. Additionally, IRS cells share functional features, including transient spiking responses to negative changes of contrast, which has led to hypothesize that they are transient Off RGCs of the alpha class; this is yet to be confirmed. Here, we first asked how IRS cells process synaptic inputs, i.e., what the dependence of excitation and inhibition is on previous stimulus history. To investigate this, we identified IRS cells and non-IRS Off sustained cells on the whole-mount retina by their spiking responses to visual stimulation and performed patch-clamp recordings of excitatory and inhibitory currents driven by a sequence of spots of either the preferred or non-preferred contrast projected on their receptive field. The inhibitory currents from IRS and non-IRS cells were similar, but the excitatory input was different, suggesting that it is important to structure the IRS spiking response. Additionally, total inhibitory and excitatory currents from IRS cells produced by transitions of recurring contrast were effectively used in a conductance-based spiking model to replicate the spiking output from saccade-like visual stimulation. To tackle the second question pertaining the identity of IRS cells, some were filled with neurobiotin supplemented through the intracellular solution, and the retina samples were processed for immunocytochemistry using an antibody against SMI-32, a known marker of alpha RGCs. Imaging of the samples reveals colocalization of the signals from the neurobiotin in the cellular soma and from the reporter of the antibody against SMI-32, which indicates that IRS cells are indeed transient Off alpha RGCs.

Model-based analysis of temporal adaptation in responses of retinal ganglion cells to spatiotemporal stimulation

Robert Mihai Haret¹, Tim Gollisch²

¹International Max Plank Research School, Neurosciences, Göttingen, Germany

²University Medical Center Göttingen, Göttingen, Germany

The spiking activity of retinal ganglion cells (RGCs) constitutes the visual sensory information that is passed from the eye towards the higher centers of the central nervous system. Different computational models aim at computing the firing rate of RGCs as a function of the visual stimulus input, thus capturing the neural encoding process.

One of the standard models used in the literature is the linear–non-linear (LN) model, which assumes linear temporal and spatial integration of the stimulus. Each cell is assumed to have a spatial and temporal filter, which can be calculated by estimating the spike-triggered average (STA) under spatiotemporal white-noise stimulation. These filters are then applied to the stimulus, and the output is passed through an identified non-linearity to yield the neuron’s predicted firing rate. Using data recorded from salamander retinas, we here focus on temporal processing. We examine how different methods of computing the temporal filter affect the prediction performance of the LN model, we assess how deviations of the model predictions from the data depend on the history of the neuron’s activity and on past stimuli, and we study extensions of the LN model that incorporate additional temporal dynamics.

Neural basis of visual information integration and decision-making

Katja Slangewal^{1,2,3,4}, Max Capelle^{1,2,3,5}, Florian Kämpf¹, Armin Bahl^{1,2,3,5}

¹University of Konstanz, AG Bahl, Universitätsstraße 10, 78464 Konstanz, Germany

²International Max Planck Research School for Quantitative Behavior, Ecology and Evolution from lab to field

³Centre for the Advanced Study of Collective Behaviour

⁴Boehringer-Ingelheim Fonds

⁵Zukunftskolleg Konstanz

Decision-making is a long-studied topic in neuroscience. We have an increasingly good mechanistic understanding of the neural circuits that allow animals to temporarily integrate specific decision variables. However, it remains unclear how these circuits combine, often conflicting, information from multiple sensory channels to form a single decision. Recently, we have described how the larval zebrafish anterior hindbrain integrates visual motion to decide about swimming direction. Other studies, focusing on different sensory stimuli, have identified the same brain area as a central processing structure for sensory-motor control. This raises the hypothesis that the anterior hindbrain forms a general integration hub for decision-making. Here, we employ a combination of behavioral experiments, computer simulations, and two-photon functional imaging to algorithmically and mechanistically describe how larvae integrate motion and luminance cues. Our behavior experiments argue for a parallel arrangement with inhibitory crosstalk, in which separate modules temporally integrate information from distinct visual processing streams. Our imaging experiments support these findings, revealing distinct and partially overlapping activation patterns with slow temporal dynamics. Together, these results allow us to build detailed neural networks that will help us to describe in mechanistic detail how brains combine and evaluate information from multiple sensory sources.

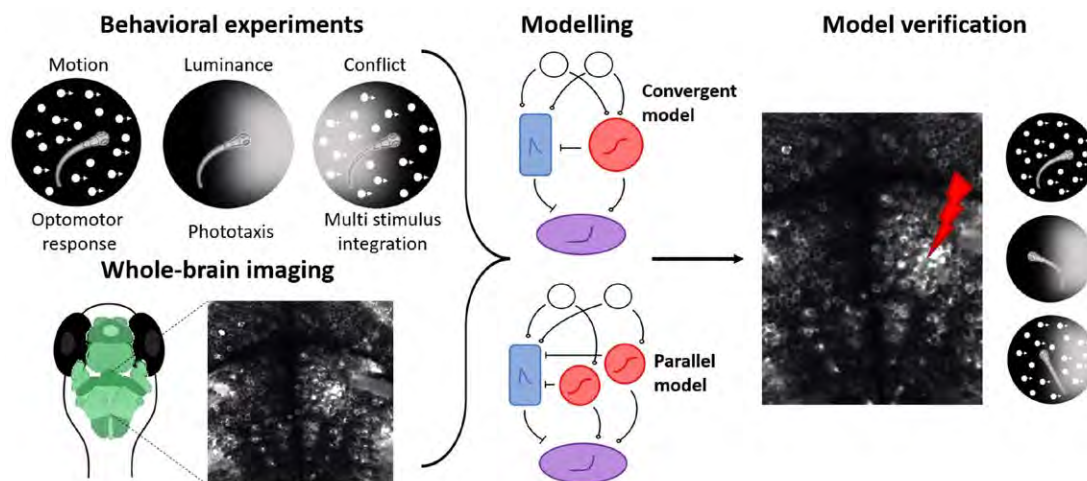

Dissection of a visual based decision-making circuit in the larval zebrafish.

Protein Interaction Network of the Complexin 4 - SNARE Complex in the Retina

Jutta Meyer¹, Uwe Lux², Olaf Jahn^{3,4}, Nils Brose¹, Johann Helmut Brandstätter², Kerstin Reim¹

¹Dept. of Molecular Neurobiology, Max Planck Institute for Multidisciplinary Sciences, 37075 Göttingen, Germany

²Division of Animal Physiology/Neurobiology, Department of Biology, Friedrich-Alexander-Universität Erlangen-Nürnberg, 91058 Erlangen, Germany

³Neuroproteomics Group, Department of Molecular Neurobiology, Max Planck Institute for Multidisciplinary Sciences, 37075 Göttingen, Germany

⁴Department of Psychiatry and Psychotherapy, University Medical Center Göttingen, Georg-August-University, 37075 Göttingen, Germany

Complexin (Cplx) proteins are key elements of the complex multi-step process that controls synaptic vesicle fusion. They bind to the SNARE complex to control high speed and spatial precision. So far, four Cplx isoforms have been described in mammals. Despite high similarity in their domain structure, the isoforms are differentially distributed. While in conventional synapses of the central nervous system predominantly Cplx1 and Cplx2 are expressed, Cplx3 and Cplx4 are present in ribbon synapses of the retinal photoreceptors and bipolar cells. In this study, we focused on Cplx4, which is the only Cplx isoform in rod photoreceptors. To better understand the mode of tonic release and to answer the question, how Cplx4 contributes to the light adaptation of rod photoreceptor ribbon synapses, we searched for interaction partners of Cplx4. For this purpose, a peptide-based affinity purification approach was performed, in which Cplx4-specific peptides representing the SNARE binding domain were incubated with retina homogenate. The eluted proteins were analyzed by quantitative mass spectrometry. Because Cplx4s are known SNARE complex interactors we first screened the proteomic data with respect to protein abundances for the neuronal SNARE components (Syntaxin 1A, SNAP25, Synaptobrevin 2) as well as the ribbon synapse-specific Syntaxin 3. Additionally, we confirmed the enrichment of these proteins by Western blot analyses. By using this strategy, we were able to show that our approach is appropriate to screen for unknown Cplx4 interactors in an unbiased manner. Interestingly, among the enriched proteins we found Transducin, which is a G protein of the phototransduction cascade. After light stimulation, rod Transducin translocates from the disks in the outer segment to the outer plexiform layer (OPL), where the ribbon synapses are located. In the OPL, a co-localization of transducin and Cplx4 was observed via a proximity ligation assay. We assume that there is an interplay between Cplx4/SNARE complex and transducin which enables the rods to optimize the signal transfer to bipolar cells under changing light conditions.

Response properties of suppressed-by-contrast cells in the early mouse visual system

Florentyna Debinski^{1,2,3}, Simon Renner^{4,5}, Emma Müller-Seydlitz⁴, Yuyang Huang^{4,5},
Timm Schubert^{1,2}, Laura Busse^{4,6}, Thomas Euler^{1,2}

¹Institute of Ophthalmic Research, University of Tübingen, Tübingen, Germany

²Center for Integrative Neuroscience, University of Tübingen, Tübingen, Germany

³Graduate Training Center of Neuroscience, International Max Planck Research School, University of Tübingen, Tübingen, Germany

⁴Division of Neurobiology, Faculty of Biology, LMU Munich, Germany

⁵Graduate School of Systemic Neurosciences (GSN), LMU Munich, Germany

⁶Bernstein Center for Computational Neuroscience, Munich, Germany

Visual information is first processed in the retina and then relayed through ~40 parallel feature channels to various visual centers in the brain. These feature channels are represented by the same number of retinal ganglion cells (RGCs). A group of RGC types share a puzzling response feature: Their activity is suppressed by many stimuli and, hence, referred to as Suppressed-by-Contrast (SbC) cells. SbC cells have also been described along the geniculo-cortical pathway, thought to underlie image-forming vision. SbC cells appear to be conserved across mammals, as they have been found in different species, including mice, macaques, cats, and rabbits. The role of SbC cells in processing of visual information is still debated; it has been suggested, for instance, that SbC cells may serve uniformity detection, signal self-induced stimulation during eye movement, and modulate contrast gain.

In this study, we aim to further our understanding of SbC cells in the early visual system, the features they encode and their role in vision. To this end, we characterize the SbC responses along the retino-geniculo-cortical pathway and compare their properties in the mouse retina, dorsolateral geniculate nucleus (dLGN) of the thalamus, and primary visual cortex (V1). For recordings in dLGN and V1, we used flashed grating stimuli with varying contrast, spatial frequency, orientation, and phase to identify SbC cells based on their decreasing contrast-response function. We find V1 SbC neurons to be mainly excitatory and located in lower cortical layers. SbC neurons in both dLGN and V1 show tuning to multiple stimulus parameters and characteristic spiking patterns. We then turned to the mouse retina, where we used two-photon calcium imaging and a battery of visual stimuli for cell type classification, including an adapted version of the flashed grating stimulus. Our preliminary experimental data suggest that retinal SbC cells can be identified using the (adapted) grating stimuli already used for dLGN and V1, but also point towards the fact that SbC responses are likely generated at multiple processing stations along the visual stream. Together, our results highlight the diversity that underlies the SbC response type, which likely spans multiple known cell types.

Super-resolution imaging in the mouse retina

Timm Schubert^{1,2}, Kseniia Sarieva^{1,2,3,4}, Leon Kremers^{1,2,3,4}, Thomas Euler^{1,2}

¹Institute for Ophthalmic Research, Tübingen

²Werner Reichardt Centre for Integrative Neuroscience, Tübingen

³Graduate Training Center of Neuroscience, Tübingen

⁴equal author contribution

Since its invention in 1994, super-resolution microscopy has become a popular tool for advanced imaging of biological structures [1]. Next to electron microscopy, it allows visualizing subcellular structures at a spatial scale below the diffraction limit. Thus, it is not surprising that different super-resolution techniques were applied e.g. to resolve clustering of neurotransmitter receptors and protein composition in presynaptic terminals [2]. All these experiments were carried out either on cell cultures or very thin tissue sections. In contrast, there are only few examples of super-resolution imaging of thick biological samples [3]. In that context, the whole-mount retina has rarely been studied with super-resolution microscopy [4].

Here, we aimed at establishing a gated-stimulated-emission-depletion (gSTED) microscopy protocol for imaging the whole-mount retina of the mouse. To this end, we adapted immunolabelling protocols against the neurofilament H by varying primary antibody concentrations, secondary antibodies and embedding media as well as microscope settings and labelled subcellular structures in somata, dendrites and axons of ganglion cells in the retinal whole-mount preparation. Under optimal conditions, we achieved a mean lateral full width of half-maximum (FWHM) of ~120 nm for the thinnest filamentous structures at a depth of ~30 µm in our preparation and a resolution enhancement of 2.2x compared to conventional confocal images. Since STED imaging has already found its application in neuroscience, we now established a gSTED protocol for reliable super-resolution imaging in the mouse retina which can be used to investigate protein composition and scaffold at retinal synapses in health and disease.

[1] Igarashi M., Nozumi M., Wu L.G., Cella Zanacchi F., Katona I., Barna L., Xu P., Zhang M., Xue F., Boyden E. "New observations in neuroscience using superresolution microscopy." *The Journal of Neuroscience*, 2018, 38(44):9459-9467.

[2] Tang A.H., Chen H., Li T.P., Metzbower S.R., MacGillavry H.D., Blanpied T.A. "A trans-synaptic nanocolumn aligns neurotransmitter release to receptors." *Nature*, 2016, 536(7615):210-214.

[3] Schnorrenberg S., Grotjohann T., Vorbrüggen G., Herzig A., Hell S.W., Jakobs S. "In vivo super-resolution RESOLFT microscopy of drosophila melanogaster." *Elife*, 2016, 5,1–11.

[4] Sigal Y.M., Speer C.M., Babcock H.P., Zhuang X. "Mapping Synaptic Input Fields of Neurons with Super-Resolution Imaging." *Cell* 163(2):493-505.

Towards a light-mediated gene therapy for the eye - retinal transgene expression through photoactivation of caged Tamoxifen and the inducible Cre/lox system

Sidney Cambridge¹

¹University of Frankfurt, Dr. Senckenbergische Anatomie, Theodor Stern Kai 7, 60590 Frankfurt am Main, Germany

Increasingly, retinal pathologies are being treated with virus-mediated gene therapies. To be able to target viral transgene expression to the pathological regions of the retina with light, we established an in vivo photoactivated gene expression paradigm for retinal tissue. Based on the inducible Cre/lox system, we synthesized a photosensitive, 'caged' version of Tamoxifen. Caged Tamoxifen was injected into the eyes of double transgenic GFAP-CreERT2 mice with a Cre-dependent tdTomato reporter transgene followed by pulsed irradiation with light of 450 nm. Photoactivation significantly increased retinal dTomato expression in living eyes compared to controls. We thus demonstrated a first step towards development of targeted, light-mediated gene therapies for eyes.

Visual encoding by retinal ganglion cells in optogenetic models for vision restoration

Varsha Ramakrishna^{1,2,3}, Tim Gollisch^{1,2}, Sonja Kleinlogel⁴

¹Universitätsmedizin Göttingen, Department of Ophthalmology, Göttingen, Germany

²Bernstein Center for Computational Neuroscience, Göttingen, Germany

³International Max Planck Research School for Neurosciences (IMPRS), Göttingen, Germany

⁴Institute of Physiology and Department of BioMedical Research (DBMR), University of Bern, Switzerland

Retinal degeneration is one of the leading causes of blindness and optogenetics as a potential therapeutic measure has garnered much attention. Light-sensitive molecules like Channelrhodopsin (ChR2) and Opto-mGluR6, a chimeric GPCR consisting of mGluR6 and melanopsin (designed by van Wyk et al.,2015) are inserted into the neurons in the inner retina to play the role of photoreceptors after their loss. Previous studies have shown responses of retinal ganglion cells (RGCs) to simple light stimuli in blind animal models with optogenetically modified retinas. Our study aims to go beyond simple light stimuli and investigate encoding by RGCs responding to spatiotemporally complex stimuli in optogenetically modified retinas. Preliminary experiments using multielectrode array recordings with retinas expressing Opto-mGluR6 showed light-dependent construct-driven responses in the RGCs. On comparing the photoreceptor-evoked and construct-evoked responses, a sign inversion in the response polarity (ON to OFF) as reported in the original work was also seen here. However, weaker responses were seen to high frequency contrast changes on activation of the construct as compared to photoreceptor-evoked responses. Also, time of the response peak to step-like increase and decrease in contrast (On-Off steps stimuli) was increased during activation of Opto-mGluR6 compared to photoreceptor-driven responses which indicates slower kinetics of the construct. This points to limitations in temporal integration by construct-evoked responses in the cells unlike those in a normal retina due to the kinetics of Opto-mGluR6 activation. Cells with double-peak responses to step-like increase in contrast in On-Off steps showed construct-driven responses which could be a cell-type specific functional feature of cells with Opto-mGluR6. Further detailed experiments are required to estimate how best the construct can be stimulated to mimic the responses of a normal retina and thus improve the method to be the optimal candidate for vision restoration.

Reference: van Wyk et al.,2015. Restoring the ON Switch in Blind Retinas: Opto-mGluR6, a Next-Generation, Cell-Tailored Optogenetic Tool. PLOS Biology

Poster Topic

T16: Vision: Striate and Extrastriate Cortex, Eye Movement and Visuomotor Processing

- [T16-1A](#) A synaptic corollary discharge signal in the optic tectum inhibits visual processing during self-motion
Johann H Bollmann, Mir Ahsan Ali, Katharina Lischka, Chintan A Trivedi, Stephanie J Preuss
- [T16-2A](#) Compromised binocular integration and reduced direction selectivity in the visual cortex of postsynaptic density protein 95 (PSD-95) knock-out mice
Masoud Kargar, Nikolaos Aggelopoulos, Susanne Dehmel, Oliver M. Schlüter, Cornelia Schöne, Siegrid Löwel
- [T16-3A](#) Context-dependent interareal synchronization in mouse visual cortex
Chockalingam Ramanathan, David Eriksson, Julia Veit
- [T16-4A](#) Cortico-cortical neurons provide direct interhemispheric communication between Layer 6 of the monocular primary visual cortices
Simon Weiler, Mateo Velez-Fort, Troy W. Margrie
- [T16-1B](#) Experience-dependent changes in visuospatial selectivity in visual cortex and hippocampus
Tom Flossmann, Nathalie Rochefort
- [T16-2B](#) Isolating the ongoing impact of specific cell-types onto recurrent circuits *in-vivo*
David Henning Eriksson, Chockalingam Ramanathan, Julia Veit
- [T16-3B](#) Loss of postsynaptic density-95 (PSD-95) leads to impaired prey capture behaviour in mice
Subhodeep Bhattacharya, Susanne Dehmel, Cornelia Schöne, Oliver M. Schlüter, Siegrid Löwel
- [T16-1C](#) Neuronal representation of color in the pigeon visual Wulst
Simon Nimpf, Harris Kaplan, Gregory Charles Nordmann, Laura Busse, David Anthony Keays
- [T16-2C](#) Orexin knock-out disrupts juvenile ocular dominance plasticity in the mouse visual cortex
Jaya Sowkyadha Sathiyamani, Tejas Shaji Nair, Siegrid Löwel, Cornelia Schöne
- [T16-3C](#) Origins of feature maps in the visual cortex
Young Jun Jung, Michael Ibbotson

A synaptic corollary discharge signal in the optic tectum inhibits visual processing during self-motion

Johann H Bollmann^{1,2,3}, Mir Ahsan Ali¹, Katharina Lischka¹, Chintan A Trivedi³,
Stephanie J Preuss³

¹Institute of Biology 1, University of Freiburg, 79104 Freiburg, Germany

²Bernstein Center Freiburg, University of Freiburg, 79104 Freiburg, Germany

³Max Planck Institute for Medical Research, Jahnstr. 29, 69120 Heidelberg

In the vertebrate brain, signals encoding visual information travel from the retina to higher visual areas, where they are processed and classified. The output is transformed in downstream circuitry into motor command signals that generate appropriate movement. Simultaneously, motor-related signals known as corollary discharge, which encode variables of the impending or ongoing movement, travel back to sensory areas so as to suppress or modulate visual signals that arise as a consequence of the animal's self-motion ('reafferent' input). While motor-associated modulation of visual neurons has been observed in many systems, the underlying mechanisms are poorly understood.

A key visual center in vertebrates for processing retinal inputs is the midbrain optic tectum (superior colliculus in mammals). Using zebrafish, we investigate whether the optic tectum is a recipient of corollary discharge signals. We use two-photon-targeted patch-clamp recordings in intact larvae to resolve synaptic inputs in genetically identified cells during visually evoked and spontaneous swim patterns. We compare the synaptic input patterns with simultaneously recorded motor nerve activity, which allows us to distinguish between different motor patterns. We found that many tectal neurons receive a phasic inhibitory synaptic input, which is temporally locked to the occurrence of saccade-like swim bouts. This synaptic corollary discharge signal is sufficient to transiently suppress visually driven spike output in tectal projection neurons. Using two-photon calcium imaging at high spatial and temporal resolution, we map the occurrence of localized calcium transients in the tectal neuropil and compare it with the occurrence of spontaneous swim bouts. Our analysis reveals a marked increase in the number of localized calcium transients in a time window a few 100 ms around a swim bout. Furthermore, we identify post-swim calcium signals, likely representing neuronal compartments involved in transmitting corollary discharge signals, and describe their spatial organization.

In summary, we provide evidence for a synaptic mechanism that mediates a transient suppression of visually driven output in the tectum at the time of swimming and describe its spatio-temporal organization. This synaptic corollary discharge signal may contribute to the perceptual phenomenon of saccadic suppression observed previously in several species.

Compromised binocular integration and reduced direction selectivity in the visual cortex of postsynaptic density protein 95 (PSD-95) knock-out mice

Masoud Kargar^{1,2,3}, Nikolaos Aggelopoulos^{1,2,4}, Susanne Dehmel^{1,4}, Oliver M. Schlüter^{4,5}, Cornelia Schöne^{1,2}, Siegrid Löwel^{1,2,4}

¹Department of Systems Neuroscience

²Göttingen Campus Institute for Dynamics of Biological Networks, University of Göttingen

³Göttingen Graduate Center for Neurosciences, Biophysics, and Molecular Biosciences

⁴Collaborative Research Centre 889 "Cellular Mechanisms of Sensory Processing", University Medical Center, Göttingen, Germany

⁵University of Pittsburgh, Pittsburgh, PA, USA

Postsynaptic density protein 95 (PSD-95) is a signalling scaffold of the PSD in excitatory synapses that regulates AMPA receptor trafficking. We have previously shown that PSD-95 dependent silent synapse maturation closes the critical period (CP) for ocular dominance plasticity in mouse V1: PSD-95 KO mice display both functional & structural hallmarks of CP plasticity and synapses cannot properly stabilize (Huang et al 2015, Favaro et al 2018, Yusifov et al 2021). Since the development of binocularity happens during the CP (Wang et al 2010, Tan et al 2021), we hypothesized that PSD-95 KOs should display compromised binocular integration. To test this hypothesis, we performed multi-electrode electrophysiological recordings in primary visual cortex (V1) of awake mice. Our data show that in PSD-95 KOs - unlike in WT - i) monocular inputs do not summate and ii) binocular responses are dominated by contralateral eye inputs, indicative of disturbed binocular interactions. In addition, PSD-95 KOs display iii) reduced direction selectivity. Since direction selectivity requires early visual experience this can likely be explained by the non-stabilized V1-synapses of PSD-95 KOs. Together, our data strongly support a role of experience-dependent silent synapse maturation for the refinement of cortical circuitry for proper binocular signal processing.

Acknowledgements: We would like to thank Profs. Laura Busse and Steffen Katzner (Ludwig Maximilian University of Munich) for sharing their data capture and analysis techniques.

Refs:

Huang et al (2015) PNAS 112:E3131

Favaro et al (2018) Plos Biol 16:e2006838

Yusifov et al (2021) PNAS 118:e2022701118

Wang et al (2010) Neuron 65:246

Tan et al (2021) Curr Biol 31:4305

Context-dependent interareal synchronization in mouse visual cortex

Chockalingam Ramanathan^{1,2}, David Eriksson¹, Julia Veit^{1,2}

¹Institute of Physiology 1, Faculty of Medicine, Albert-Ludwigs University of Freiburg, Hermann-Herder-Str. 7, 79104 Freiburg im Breisgau, Germany

²Bernstein Center Freiburg, Albert-Ludwigs University of Freiburg, Hansastrasse 9A, 79104 Freiburg im Breisgau, Germany

Most brain functions rely on constant interaction between specialized brain areas. In primates, it has been suggested that synchronized oscillations in distinct frequency bands could serve to route feedforward and feedback signals across hierarchically organized visual areas. However, the underlying circuit mechanisms are still unknown. Preliminary data from our lab and others point to similar spectral segregation in the mouse visual system. We utilized visually induced oscillations to study the interareal interactions across mouse visual cortical areas.

To this end, we performed simultaneous multi-areal extracellular recordings in retinotopically aligned locations in V1 and LM (homolog of primate V2) of awake, head-fixed mice using Neuropixels probes. We presented a diverse set of visual stimuli to investigate the stimulus dependence and the laminar profile of different oscillations, as well as their coherence across these two regions.

In brief, we observed two distinct gamma rhythms - (i) a context- and layer-dependent visually induced gamma rhythm (~30Hz) in LM, which was previously reported in V1 and (ii) a narrowband, behavioural-state and luminance-dependent 60Hz gamma rhythm which is suppressed by most visual stimuli and strongest in the input layers in both regions. Furthermore, our preliminary results indicate two additional stimulus-dependent frequency bands around 4Hz and 15Hz, respectively. Coherence analysis points to four different laminar networks of interactions across different frequencies which we are currently investigating in detail.

Cortico-cortical neurons provide direct interhemispheric communication between Layer 6 of the monocular primary visual cortices

Simon Weiler¹, Mateo Velez-Fort¹, Troy W. Margrie¹

¹Sainsbury Wellcome Centre for Neural Circuits and Behaviour, University College London, 25 Howland Street, W1T4JG London, United Kingdom

Callosal projection neurons (CPNs) mediate information processing for integration between the two cortical hemispheres. To date, CPNs have been mainly described as bridging different sensory cortical layers via projections to and from Layers 2/3 and 5. Functionally, these CPNs have been shown to recruit cell-type specific circuits, serving bilateral tactile integration in the primary somatosensory or sound localization in the primary auditory cortex.

Using brain-wide viral retrograde and anterograde transsynaptic tracing followed by serial two-photon tomography and deep-learning based 3D detection of labelled cells, we find that callosal input to the primary visual cortex (VISp) of mice is dominated by a subset of layer 6 (L6) cortico-cortical (CC) neurons that does not include L6 cortico-thalamic (CT) projecting cells. *In vivo* transaminar Neuropixels recordings of neuronal activity show that optogenetic activation of L6 CPNs in the monocular area of VISp drive either short-latency increases or decreases in the firing rate of individual neurons across layers of the contralateral monocular VISp region. *In vitro* whole-cell recordings from VISp L6 together with optogenetic stimulation of the callosal input also showed that CPNs evoke excitatory post-synaptic currents (EPSCs) in both callosal projecting and callosal non-projecting CC, CT and inhibitory cell types such as fast-spiking Parvalbumin (PV) and Somatostatin-expressing interneurons. In stark contrast to previously studied callosal-recipient neurons, we find that CPN stimulation evokes monosynaptic EPSCs of similar amplitude in all interhemispheric L6 target cell types. However, due to their differences in intrinsic properties, PV interneurons recorded in current clamp were the only class of neurons found to display CPN-evoked action potential activity. Such PV activation was further found to be responsible for the CPN-evoked di-synaptic inhibition observed in all types of L6 target neurons.

We suggest that due to both the abundance and strength of this interhemispheric connection, callosal input profoundly influences both local cortical and subsequent thalamic processing via its integration with L6 microcircuits. Furthermore, convergence in L6 of eye-specific visual field information suggests that, even within the 'classically-defined' monocular region of mouse VISp, the cortex is performing binocular computations.

Experience-dependent changes in visuospatial selectivity in visual cortex and hippocampus

Tom Flossmann¹, Nathalie Rochefort¹

¹University of Edinburgh, Centre for Discovery Brain Sciences, 15 George Square, EH8 9XD Edinburgh, United Kingdom

Exploration and exploitation of an animal's ecological environment are critical for survival. Seminal studies demonstrate hippocampal place cells underly the internal representation of space by integrating self-motion and sensory information. Spatial mapping of the environment by the hippocampal CA1 population is strongly affected by visual cues. Visual stimuli evoke neuronal activity in the rodent CA1 even in absence of locomotion while, in experienced rodents, visual tuning in primary visual cortex (V1) is modulated by hippocampal theta oscillations and internal spatial representations.

How the reciprocal interaction between hippocampus and visual cortex is established during early learning remains incompletely understood. Here, we asked how visuospatial information in both V1 and hippocampal CA1 changes during exploration and learning of a new virtual environment in which the water-restricted mouse has to lick for a reward at a given location. Using multi-electrode silicone probes (Neuropixels) for acute recordings we monitor changes of visuospatial responses in V1 and CA1 respectively, during early learning of the task.

Preliminary results show that most V1 neurons are visuospatially tuned during the first trial and more neurons become tuned with learning the task. In contrast, we find a smaller proportion of CA1 neurons to be tuned during early trials. With experience, spatial tuning emerges in many CA1 neurons and remaps during subsequent runs correlating with changes in behavioural performance. We are currently analysing the experience-dependent changes of activity in both areas. The expected results will reveal how internal representations are formed in both CA1 and V1 during early learning of a task in a new visual environment.

Isolating the ongoing impact of specific cell-types onto recurrent circuits *in-vivo*

David Henning Eriksson¹, Chockalingam Ramanathan¹, Julia Veit¹

¹Physiology 1, AG Veit, Hermann-Herder-Str. 7, 79104 Freiburg, Germany

Recurrent circuits in the brain have the means to generate activity sequences and high-dimensional trajectories for sensory prediction, problem-solving, and motor output. However, recurrent circuits are inherently difficult to study. By reverberating previous activity states, they cause long-term correlations that undermine mathematical scrutiny of the underlying physiology.

Here we asked whether it is possible to causally estimate the isolated impact of ongoing parvalbumin- (PV) and somatostatin-cell (SOM) inhibition onto principal cells (PC). These interneuron types not only form some of the most robust loops in the brain but the resulting dynamics - for example, gamma oscillations - are thought to govern sensory and cognitive processing. We aimed at extracting an “impact function” $\mathbf{T} = IF(\mathbf{S}, \mathbf{B})$, where \mathbf{T} is the PC activity, \mathbf{S} is the PV (or SOM) activity, and \mathbf{B} is the background PC activity during inhibition of PV (or SOM) according to the triplet-principle (\mathbf{S} , \mathbf{B} , and \mathbf{T}) described previously (Eriksson 2017, *Front. Neural Circuits*).

To this end we expressed eArch 3.0 (n=1 mice) or Jaws (n=7 mice) in PV or SOM cells. We recorded and manipulated activity using ultrathin side-light optical fibers attached to Neuropixels probes in the primary visual cortex of the awake head-fixed mouse. We registered the PV/SOM activity (\mathbf{S}) before a brief (20ms), transient suppression of PV/SOM cells, as well as the activity of PC neurons before (\mathbf{T}) and during (\mathbf{B}) the inhibition.

As proof of concept, we correlated the pre-suppression activity of each photo-tagged neuron (\mathbf{S}) with each target neuron's resulting activity modulation ($\mathbf{T}-\mathbf{B}$). In contrast to the classical cross-correlation (between \mathbf{S} and \mathbf{T}), which has a positive peak due to the balanced excitation and inhibition, the impact function showed a negative correlation, revealing the suppressive influence of PV and SOM neurons on their targets.

We quantified how the impact function decayed with the distance between the source and target neuron. Consistent with spurious correlations from recurrent dynamics and common inputs, the classical cross-correlation resulted in a spatial decay that was 11-67.5% larger than the impact function. This reveals a new method to more accurately quantify computations in brain circuits *in-vivo*, even if they are embedded in extensive recurrent networks.

Loss of postsynaptic density-95 (PSD-95) leads to impaired prey capture behaviour in mice

Subhodeep Bhattacharya^{1,2,3,4}, Susanne Dehmel^{1,3}, Cornelia Schöne^{1,2}, Oliver M. Schlüter^{3,5,6}, Siegrid Löwel^{1,2,3}

¹Department of Systems Neuroscience, University of Göttingen

²Göttingen Campus Institute for Dynamics of Biological Networks

³Collaborative Research Center 889 "Cellular Mechanisms of Sensory Processing"

⁴Göttingen Graduate Center for Neurosciences, Biophysics, and Molecular Biosciences, University of Göttingen

⁵University Medical Center, Göttingen, Germany

⁶University of Pittsburgh, Pittsburgh, PA, USA

Postsynaptic density protein 95 (PSD-95) is an important signalling scaffold present in the PSD of excitatory synapses. We have previously shown that PSD-95 dependent AMPA silent synapse maturation closes the critical period (CP) for ocular dominance plasticity in mouse primary visual cortex (V1): PSD-95 KO mice display both functional and structural hallmarks of CP plasticity and synapses cannot properly stabilize (Huang et al 2015, Favaro et al 2018, Xu et al 2020; Yusifov et al 2021). Since binocularity develops during the CP, we hypothesised that PSD-95 KO mice should display impaired binocular integration. In fact, PSD-95 KO mice are better in orientation discrimination (assessed by the visual water task) under monocular compared to binocular conditions, unlike WTs, who got worse. To test whether this phenotype also persists in an ethologically more relevant behaviour, we tested mice in the prey capture task, shown to exploit binocular vision (Hoy et al 2016, Michael et al 2020, Johnson et al 2021) under both binocular and monocular conditions. In fact, PSD-95 KOs were worse compared to WT in catching crickets. Together with the poster of Masoud Kargar et al. our data support a role of experience-dependent silent synapse maturation for the refinement of cortical circuitry for proper binocular signal processing.

Acknowledgements: We would like to cordially thank Cris Niell (University of Oregon) & Jennifer Hoy (University of Nevada) for providing the template analysis pipeline and their insightful suggestions while setting up the task.

Neuronal representation of color in the pigeon visual Wulst

Simon Nimpf¹, Harris Kaplan², Gregory Charles Nordmann¹, Laura Busse¹, David Anthony Keays^{1,3,4}

¹Ludwig-Maximilian-University Munich, Division of Neurobiology, Großhaderner Straße 2, D-82152 Planegg-Martinsried, Germany

²Harvard University, Department of Molecular and Cellular Biology, 16 Divinity Avenue, MA 02138, Cambridge, USA

³University of Cambridge, Department of Physiology, Development and Neuroscience, Downing Street, CB2 3EG, Cambridge, UK

⁴Research Institute of Molecular Pathology (IMP), Vienna Biocenter (VBC), Campus-Vienna-Biocenter 1, 1030, Vienna, Austria

For many animals color vision is critical to make sense of their environment. Whether it's choosing the ripest fruit or identifying a potential mate, the perception of color is vital for the execution of these complex behaviors. How colors are processed in the central nervous system of di- and trichromatic vertebrate species has been topic of considerable research over the last decades. In contrast, the neuronal circuits supporting color vision in tetrachromatic vertebrates, such as birds, remain less well understood.

Using newly developed *in vivo* 2-photon calcium imaging methodology, high-density, multi-channel Neuropixels silicon probes and whole brain clearing technology, we aim to investigate the neuronal representation of color in the visual Wulst of pigeons, the functional homologue of the mammalian primary visual cortex. Preliminary calcium imaging experiments in awake pigeons demonstrate that neurons in the visual Wulst are selectively tuned to a broad range of wavelengths covering the pigeon's visual spectrum. Response profiles can be classified into three main groups: (1) cells that show a sustained increase in activity in response to spectral stimulation (ON cells), (2) cells that respond with a sustained decrease in activity during stimulation followed by an offset response (OFF cells), and (3) cells that display both ON and OFF responses (ON/OFF cells).

This project aims to advance our knowledge of visual processing beyond standard model organisms, potentially giving us insights into optical worlds we cannot appreciate but also help us understand commonalities between the evolutionary ancient visual apparatus of birds and our own visual sense. Ultimately, this project will provide us with a bird's eye view of the world.

Orexin knock-out disrupts juvenile ocular dominance plasticity in the mouse visual cortex

Jaya Sowkyadha Sathiyamani^{1,2}, Tejas Shaji Nair^{1,2}, Siegrid Löwel^{1,3}, Cornelia Schöne^{1,3}

¹Department of Systems Neuroscience, University of Göttingen ²International Max Planck Research School for Neurosciences, Göttingen ³Göttingen Campus Institute for Dynamics of Biological Networks

Previous studies have highlighted that lateral hypothalamic orexin (hypocretin) circuits drive both physical and cortical arousal as they increase locomotion and high gamma wakefulness (Sakurai 2007, Vassalli & Franken 2017, Karnani et al 2020). In turn, physical activity and cortical gamma activity are key physiological variables affecting signal-to-noise ratio, gain and plasticity of neuronal responses in the primary visual cortex (V1) (Niell & Stryker 2010, Saleem et al 2017, Löwel et al 2018). Moreover, orexins also directly activate visual circuits (Bayer et al 2004, Chrobok et al 2017). Given the links between orexin and visual circuits, we tested if orexin signalling plays a role for experience-dependent rewiring of V1 by using the classic ocular dominance plasticity (ODP) paradigm in juvenile orexin knock-out (KO) and wildtype (WT) mice. During the critical period for ODP, 4 days of monocular deprivation (MD) are sufficient to shift ocular dominance towards the open eye, as measured using intrinsic signal optical imaging (OI), and quantified by calculating an ocular dominance index (ODI, Cang et al 2005). In fact, juvenile orexin KO mice (P30-P35 at day of OI) fail to show ODP (ODI, WT: 0.028 ± 0.027 , KO: 0.234 ± 0.037 , $p < 0.01$, unpaired t-test), and the closed contralateral eye continued to dominate V1 ($p < 0.005$, 2-way ANOVA, Sidak post-hoc test). In contrast, in WT-mice, ODP was present and V1 was about equally well activated by visual stimulation of both eyes (V1-activation, WT, contra/ipsi: $1.65 \pm 0.16 / 1.66 \pm 0.15$, KO, contra/ipsi: $1.78 \pm 0.20 / 1.16 \pm 0.14$). Basic visual abilities as assessed by the spatial frequency threshold of the optokinetic reflex (Prusky et al 2004) were similar between genotypes at baseline, and thresholds similarly increased after MD (baseline/MD, WT: $0.39 \pm 0.00 / 0.47 \pm 0.01$ cycles per degree (cpd), KO: $0.39 \pm 0.03 / 0.47 \pm 0.00$ cpd; $p > 0.05$ effect of genotype; $p < 0.0001$ effect of day, 2-way ANOVA). Together, our data strongly support the involvement of orexin neuropeptides in experience-dependent rewiring of mouse V1. Further studies will elucidate the mechanism of orexins' actions.

Refs:

Bayer et al (2004) J Neurosci 24:6760
Cang et al (2005) Neuron 65:246
Chrobok et al (2017) Sci Rep 7:7713
Karnani et al (2020) Prog Neurobiol 187:101771
Löwel et al (2018) E-Neuroforum 24:A19
Niell & Stryker (2010) Neuron 65:472
Prusky et al (2004) Invest Ophthalmol Vis Sci 45:4611
Sakurai (2007) Nat Rev Neurosci 8:171
Saleem et al (2017) Neuron 93:315
Vassalli & Franken (2017) PNAS 114:E5464

Origins of feature maps in the visual cortex

Young Jun Jung¹, Michael Ibbotson¹

¹National Vision Research Institute, Optometry and Vision Sciences, Cardigan Street, 3053 Carlton, Australia

The spatial relationships within an image are preserved in the primary visual cortices (V1) of mammals in the form of retinotopic maps. In eutherian cats and primates, neurons viewing each, small region of visual space also segregate into pinwheel-like structures, where each pinwheel segment codes a particular edge orientation. Therefore, each pinwheel codes all orientations in each region of space in an ordered pattern. Eutherian rodents and rabbits also have retinotopic maps in V1, but orientation selective neurons are intermingled, so there are at least two different visual feature mapping strategies in mammalian cortex. What is the phylogeny of these coding strategies in V1? We will describe how we have for the first time studied orientation maps in marsupials, which split from the eutherian mammals 160 million years ago, and how we have combined our findings with investigations in other mammalian branches to create a theory on the origins of orientation preference (OP) maps in mammals.

We will explain how pinwheel OP maps could be the ancestral design, as we find that all mammalian branches studied so far except the recently evolved Eutherian rodents and rabbits appear to have pinwheel OP maps. Our findings from the wallaby V1 suggest that the required genetics for pinwheel formation are likely present in all mammals, but are only revealed when the visual ecology of a species demands concentration of retinal sampling and associated divergence of connectivity from the retina to cortex. We will describe how pinwheel OP map structure might be directly related to retinal structure. Using the limited existing data where retinal and cortical structures are known in the same species, we found that the CP ratio, which is the ganglion cell density at the peak or center (C) of the retinal specialization divided by the peripheral (P) retinal density, accurately predicts the type of OP map. In species with CP ratios of <4 , pinwheel maps are absent, but for species with CP ratios of >7 , pinwheel maps are present. The wallaby has a CP ratio of 20 and, as with all species studied so far with CP ratios of >4 , wallabies have pinwheels in V1. So far, all mammals with salt-and-pepper OP maps are rodents or rabbits with little retinal specialization, while those with pinwheel OP maps tend to be sophisticated species with complex retinal specializations and binocular lifestyles (e.g., arboreal or predatory). We believe that there is strong a link between retinal and cortical structure, and it is likely that cortical structure have been highly influenced by the environments in which those visual systems have evolved.

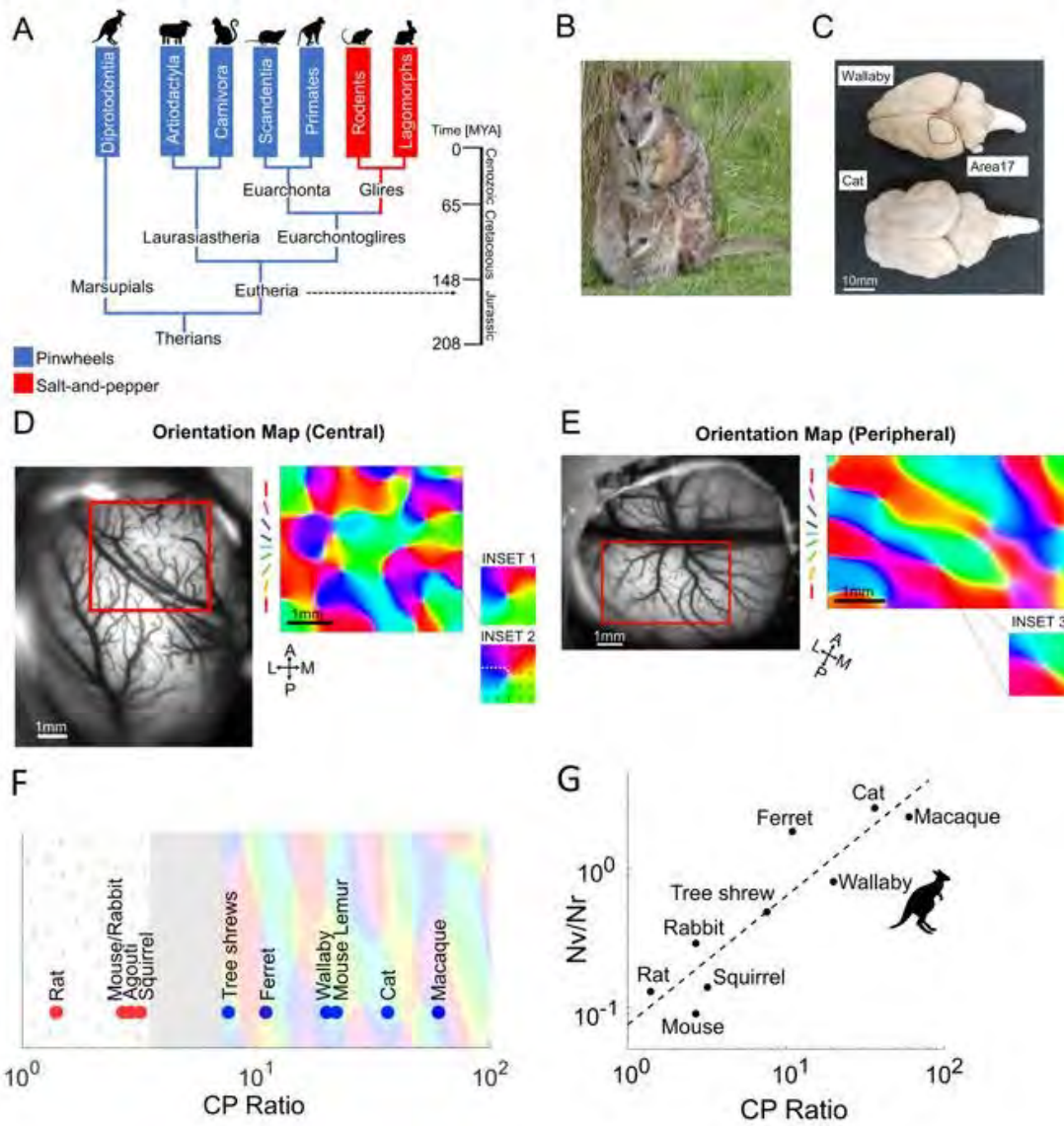

Orientation pinwheels in primary visual cortex of a highly visual marsupial (A) A simplified mammalian phylogenetic tree. Mammalian order names with blue backgrounds have a pinwheel-like organization of orientation selectivity in V1. Order names with backgrounds in red have salt-and-pepper cortical organization. Ma ago, million years ago. (B) A standing tamar wallaby with pouch young. (C) Size comparison of a wallaby and a cat brain. The vasculature images of the entire cortical area and the OP maps obtained in the selected region of interest (in red) from the (D) central and (E) peripheral visual field of wallaby V1. Preferred orientations are color-coded according to the scheme in the legend. (F) Relationship between organization of RGCs and OP map structure. Presence of pinwheels plotted against the CP ratios. (G) For each species, CP ratios are plotted against the ratios between the number of V1 neurons and RGCs (NV/NR) to predict V1 organization. There is a strong linear correlation between CP ratios and (NV/NR) ($r^2 = 0.71$, $P = 0.001$).

Poster Topic

T17: Auditory Mechanoreceptors, Vestibular, Cochlea, Lateral Line and Active Sensing

- [T17-1A](#) Analyzing the TRP channel interactomes in the Drosophila hearing organ
Majid Bahader, Martin Göpfert
- [T17-2A](#) Autosomal dominant auditory neuropathy type 2 is caused by loss of spiral ganglion neurons due to a mutation in ATP11A.
Nicola Strenzke, Shashank Chepurwar, Sarah von Loh, Daniela Wigger, Jakob Neef, Dirk Beutner, Ruth Lang-Roth, Christian Kubisch, Alexander E. Volk
- [T17-3A](#) CaBP2 and 1 together prevent inactivation of CaV1.3 channels at the IHC ribbon synapses and enable sustained neurotransmission
Shashank Sharad Chepurwar, David Oestreicher, Tatjana Pallinger, Kathrin Kusch, Vladan Rankovic, Sangyong Jung, Nicola Strenzke, Tina Pangrsic
- [T17-4A](#) Characterization of promoter expression in spiral ganglion neurons and hair cells *in vitro*
Mara Uhl, Dominik Simon Botermann, Tabea Quilitz, Burak Bali, Lennart Roos, Lena Lindner, Alica Blenkle, Tobias Moser, Christian Wrobel, Kathrin Kusch
- [T17-5A](#) Cholesterol Metabolism and Trafficking in the Organ of Corti
Yuna Werchner, Roos Voorn, Christian Vogl, Tobias Moser, Lina Maria Jaime Tobon
- [T17-6A](#) Development of earphone-type noninvasive auditory prostheses with infrared laser-based technology
Yuta Tamai, Miku Uenaka, Aya Okamoto, Keito Hosokawa, Shizuko Hiryu, Kohta I. Kobayasi
- [T17-1B](#) Imaging auditory processing in crickets using extracellular loading of Ca²⁺ tracers
Berthold Hedwig, Xinyang Zhang, Darron Cullen, Fernando Montealegre-Z
- [T17-2B](#) Impact of conventional neonicotinoid insecticides and a novel alternative on auditory processing in the desert locust *Schistocerca gregaria*
Marcelo Christian, Michelle Kraft, Paul Wilknitz, Manuela Nowotny, Stefan Schöneich
- [T17-3B](#) The potassium channel Eag contributes to variance adaptation in primary auditory neurons of *Drosophila melanogaster*
Julian Rafael Rottschäfer, Jan Clemens

- [T17-4B](#) Optogenetic stimulation reduces spectral spread of cochlear implants – a modeling study
Lakshay Khurana, Daniel Keppeler, Lukasz Jablonski, Tobias Moser
- [T17-5B](#) Paralemmin-3 – an essential constituent of the plasma membrane of auditory hair cells
Victoria Christine Halim, Iman Bahader, Thomas Effertz, Kathrin Kusch, Nicola Strenzke, Manfred Kilimann, Christian Vogl
- [T17-6B](#) Quantification of cochlear neurons based on light sheet microscopy
Anupriya Thirumalai, Tabea Quilitz, Antoine Huet, Tobias Moser
- [T17-1C](#) Reconstitution of synthetic ribbon-type active zones in a heterologous system: in pursuit of dissecting the molecular organization and dynamics of *presynaptic* Ca²⁺ channels.
Rohan Kapoor, Niko Schwenzer, Thomas Dresbach, Tobias Kohl, Stefan Lehnart, Tobias Moser
- [T17-2C](#) Sensitivity tuning of *Drosophila* Hearing
Philip Hehlert, Thomas Effertz, Ruo-Xu Gu, Bert De-Groot, Dirk Beutner, Martin C. Göpfert
- [T17-3C](#) Sound processor and driver for optical cochlear implants enabling behavioural experiments in freely moving animals
Lukasz Jablonski, Tamas Harczos, Gerhard Hoch, Tobias Moser
- [T17-4C](#) The Role of Vision for Frequency Discrimination and Path Integration in an Active Listening Paradigm
Annalena Malzacher, Tobias Hilbig, Michael Pecka, Dardo N. Ferreira
- [T17-5C](#) Towards behavioral evaluation of a multichannel optogenetic cochlear implant
Bettina Julia Wolf, Lukasz Jablonski, Tamas Harczos, Alexander Dieter, Christian Dullin, Patrick Ruther, Tobias Moser
- [T17-6C](#) VGLUT3-Dependent Glutamatergic Quantal Transmission in Peripheral Vestibular Function
Mohona Mukhopadhyay, Aizhen Yang-Hood, Kevin K. Ohlemiller, Maolei Xiao, Mark Warchol, Mark Rutherford, Tina Pangrsic

Analyzing the TRP channel interactomes in the *Drosophila* hearing organ

Majid Bahader¹, Martin Göpfert²

¹Schwann-Schleiden Research Centre, Dept. of Cellular Neurobiology, Julia-Lermontowa-Weg 3, 37077 Göttingen, Germany

Hearing in *Drosophila* relies on ciliated sensory neurons of Johnston's organ (JO) in the second antennal segment. JO neurons are motile and actively amplify the mechanical input of the ear. It has been found out already that two interdependent TRPV channel subunits Inactive (IAV) and Nanchung (NAN) occur in chordotonal cilia and are required for hearing. How these channels are integrated molecularly, however, has hitherto not been addressed. We previously showed that NAN and IAV interact, forming a heteromeric ion channel. How NAN- IAV heteromers are integrated molecularly in JO neuron cilia, however, has hitherto not been addressed. In my thesis, I will characterize the interactome of NAN- IAV in JO neurons. In particular, I want to unravel whether NAN- IAV interact directly with microtubules and axonemal dynein motor components. Depending on the progress, additional auditory relevant TRP channels will be included in the analysis. Besides NAN- IAV, the mechanosensory function of JO neurons involves TRPN1 (NOMPC) and TRPML channels. Using these channels as starting points, my thesis aims to contribute to our understanding of the molecular composition of mechanotransduction machineries.

Autosomal dominant auditory neuropathy type 2 is caused by loss of spiral ganglion neurons due to a mutation in ATP11A.

Nicola Strenzke¹, Shashank Chepurwar¹, Sarah von Loh², Daniela Wigger³, Jakob Neef¹, Dirk Beutner⁴, Ruth Lang-Roth⁴, Christian Kubisch², Alexander E. Volk²

¹University Medicine Göttingen, Institute for Auditory Neuroscience, Robert-Koch-Str 40, 37075 Göttingen, Germany

²University Hospital Hamburg-Eppendorf

³University of Ulm

⁴University of Cologne

Auditory neuropathy is a hearing disorder caused by a primary defect of sound encoding in spiral ganglion neurons (SGNs). Sound discrimination is more strongly impaired than sound perception thresholds, as the latter are mostly determined by active cochlear amplification.

Human non-syndromic autosomal dominant auditory neuropathy type 2 (AUNA2) has previously been mapped to chromosomal bands 12q24 or 13q34 (Lang-Roth et al. 2017). Affected individuals show an age-dependent increase in sound thresholds and poor or absent auditory brainstem responses despite relatively well-preserved otoacoustic emissions. However, speech perception is not as severely impaired as in other forms of auditory neuropathy.

We now detected by whole genome sequencing a 5500bp deletion in *ATP11A* located in 13q34, expected to cause truncation of both possible isoforms of the P4-ATPase ATP11A. It is a flippase which actively translocates phosphatidylserine and phosphatidylethanolamine from the exoplasmic to the cytoplasmic leaflet of plasma membranes. The deletion preserves ATP11A expression but reduces flippase activity in vitro.

In mice, high levels of *Atp11a* expression are observed in all afferent spiral ganglion neurons. Conditional *Atp11a* knockout mice under the Parvalbumin-Cre promotor show an age-progressive loss of auditory brainstem responses despite preserved DPOAE, recapitulating the age-progressive human auditory neuropathy phenotype. In mutants, we observed a significant loss of hair cell ribbon synapses, suggesting loss of SGNs. Preliminary data indicate reduced action potential rates in SGN single unit recordings in vivo and we suspect a selective loss of the fraction of SGNs with high spontaneous and evoked firing rates.

By multidisciplinary analysis, we show that AUNA2 is caused by a mutation in *ATP11A* which reduces flippase activity and likely causes progressive loss of SGNs. Possibly, the degenerative process preferentially affects the fraction of SGNs that have high spontaneous and evoked firing rates.

CaBP2 and 1 together prevent inactivation of CaV1.3 channels at the IHC ribbon synapses and enable sustained neurotransmission

Shashank Sharad Chepurwar¹, David Oestreicher¹, Tatjana Pallinger¹, Kathrin Kusch¹,
Vladan Rankovic¹, Sangyong Jung¹, Nicola Strenzke¹, Tina Pangrsic¹

¹University of Goettingen, Institute of Auditory Neuroscience, Germany

The encoding of continuous sound stimuli by the Inner Hair Cells (IHCs) of the inner ear is regulated by Calcium Binding Proteins (CaBPs). Mutations in the human CaBP2 gene cause autosomal recessive progressive hearing loss DFNB93. In a previous study we found enhanced calcium- and voltage-dependent inactivation of CaV1.3 calcium currents at IHC ribbon synapses in CaBP2 knockout mice, resulting in a mild change in spike rate adaptation in spiral ganglion neurons. Apart from other CaBPs expressed in the auditory system, CaBP1 is most structurally similar to CaBP2 and could partially compensate for a genetic loss of CaBP2. Here, we investigated the *Cabp1* and *2* double-knockout mice to understand the combined function of these two proteins. In our analysis of the mouse phenotype from systems to cellular level, we find evidence for overlapping functions of these proteins. The combined loss of *Cabp1* and *Cabp2* in mice results in strongly enhanced Cav1.3 inactivation and a reduction of sustained exocytosis. It was very difficult to detect any sound-evoked single unit responses in vivo in the region where the auditory nerve enters the cochlear nucleus. The thresholds of the sound-responsive neurons were very high and spike rates low. Spiking showed a striking enhancement of adaptation and a delayed recovery from adaptation, resulting in much improved spike rates when very long silent interstimulus intervals were used. Auditory brainstem responses were strikingly reduced in amplitude. IHC exocytosis and ABR thresholds partially recovered upon virus-mediated transgenic expression of *Cabp2*. We conclude that CaBP1 and 2 together reduce CDI and VDI of IHC CaV1.3 channels by suppressing channel inactivation and speeding up recovery from inactivation, thus supporting a sufficiently high exocytosis rate to enable indefatigable sound encoding.

Characterization of promoter expression in spiral ganglion neurons and hair cells *in vitro*

Mara Uhl^{1,7}, Dominik Simon Botermann^{1,7}, Tabea Quilitz^{1,7}, Burak Bali^{1,7}, Lennart Roos^{1,2,3,4}, Lena Lindner^{1,2}, Alica Blenkle^{1,2}, Tobias Moser^{1,2,3,4,5,6}, Christian Wrobel^{1,2}, Kathrin Kusch^{1,7}

¹Institute for Auditory Neuroscience and InnerEarLab, University Medical Center Göttingen, 37075 Göttingen, Germany.

²Department of Otorhinolaryngology, University Medical Center Göttingen, 37075 Göttingen, Germany.

³Collaborative Research Center 889, University of Göttingen, Göttingen, Germany.

⁴Cluster of Excellence "Multiscale Bioimaging: from Molecular Machines to Networks of Excitable Cells" (MBExC), University of Göttingen, Göttingen, Germany.

⁵Advanced Optogenes Group, Institute for Auditory Neuroscience and InnerEarLab, University Medical Center Göttingen, Germany, 37075, Göttingen, Germany.

⁶Auditory Neuroscience and Optogenetics Group, German Primate Center, 37077 Göttingen, Germany.

⁷Functional Auditory Genomics Group, Auditory Neuroscience and Optogenetics Laboratory, German Primate Center, Göttingen, Germany.

Hair cells (HCs) inside the cochlea are the sensory receptors of the auditory system and transmit their signal via spiral ganglion neurons (SGNs) towards the brain. Thus, both of these cell types play a pivotal role in hearing and present a promising target for a potential gene therapy. However, strong and cell type specific expression of a transgene is still demanding. Therefore, the characterization of potential promoters that drive target gene expression in either HCs or SGNs is essential to specifically modulate these cells and potentially restore hearing.

In order to identify cell type specific promoters, RNAseq data (umgear.org) were screened for genes specifically and highly expressed in HCs and SGNs, corresponding promoter elements were cloned and their *in vitro* activity was analyzed by luciferase assay. Successfully evaluated promoters were used to drive transgene expression of f-Chrimson, a promising fast-gating channelrhodopsin, in murine cochlea after early postnatal adenovirus associated virus injection. Promotor function was examined *in vivo*, by recording functional responses to optogenetic stimulation (optically evoked auditory brainstem responses, oABR) followed by analysis of cochlear f-Chrimson expression by immunohistology.

Preliminary data shows that the selected promoters are capable to drive transgene expression sufficiently to enable oABRs. Additionally, histological analysis revealed cell type specific expression of the transgene in HCs or SGNs, respectively.

Taken together, our data indicates that we can specifically target HCs and SGNs *in vivo* and this will further support research towards the development of gene therapy.

Cholesterol Metabolism and Trafficking in the Organ of Corti

Yuna Werchner^{1,4,5}, Roos Voorn^{3,4,6}, Christian Vogl^{2,3,4,6}, Tobias Moser^{1,3,4,5}, Lina Maria Jaime Tobon^{1,3,4,5}

¹Auditory Neuroscience and Synaptic Nanophysiology Group, Max Planck Institute for Multidisciplinary Sciences, Am Fassberg 11, 37077 Göttingen, Germany

²Auditory Neuroscience Group, Institute of Physiology, Medical University Innsbruck, Schöpfstraße 41, 6020 Innsbruck, Austria

³Collaborative Research Center 889, University Medical Center Göttingen, Robert-Koch-Straße 40, 37075 Göttingen, Germany

⁴Institute for Auditory Neuroscience, University Medical Center Göttingen, Robert-Koch-Straße 40, 37075 Göttingen, Germany

⁵Multiscale Bioimaging of Excitable Cells, Cluster of Excellence, Robert-Koch-Straße 40, 37075 Göttingen, Germany

⁶Presynaptogenesis and Intracellular Transport in Hair Cells Junior Research Group, Institute for Auditory Neuroscience and InnerEarLab, University Medical Center Göttingen, Robert-Koch-Straße 40, 37075 Göttingen, Germany

Background: Cholesterol is a crucial component of animal cells, where it stabilizes and stiffens the membrane and modulates ion channel function. These two functions are important for synaptogenesis and synaptic transmission, which rely on active zones with proper localization, spatial organization and correct function of their molecular players such as voltage-gated Ca²⁺ channels. Such properties might be particularly crucial at high-throughput synapses – such as the ones between cochlear inner hair cells (IHCs) and afferent spiral ganglion neurons.

IHCs are the sensory cells that transduce sound into electrochemical signals to trigger afferent activity in the auditory pathway and thus make hearing possible. IHCs are found in the organ of Corti, a highly organized sensory epithelium that consists of IHCs, outer hair cells (OHCs) and a variety of supporting cells (SCs). It has previously been shown that disruption of cholesterol homeostasis within the organ of Corti leads to hearing impairment. On a cellular level, cholesterol disruption results in dysfunction of OHC electromotility and IHC potassium channels as well as in a structural collapse of hair bundles.

To date, physiological cholesterol homeostasis and its key players within the organ of Corti remain poorly understood. We hypothesize that IHCs require high amounts of cholesterol to mature synapses and maintain their high and sustained synaptic activity. We further hypothesize that IHCs rely on exogenous cholesterol provided by SCs to satisfy this demand and that the level of *de novo* cholesterol synthesis declines with advancing age. Our aim for this study was to characterize the synthesis, uptake and trafficking of cholesterol within the organ of Corti.

Methods: To study the synthesis of cholesterol, we performed RNAscope, single cell RNAseq and single cell RT-qPCR to compare the expression levels of enzymes involved in cholesterol synthesis among IHCs, OHCs and SCs. In order to study the uptake and trafficking of cholesterol, we performed live cell imaging of organotypically-cultured organs of Corti incubated in fluorescent cholesterol analogs.

Results: Our results show that IHCs and OHCs take up cholesterol from the extracellular medium into vesicular organelles located at the cellular apex. In comparison, the surrounding SCs display less

cholesterol uptake. To show that this uptake is a regulated mechanism that depends on cellularly available cholesterol, we disrupted cholesterol homeostasis by depleting cholesterol from the membrane or inhibiting its intracellular trafficking via the endolysosomal pathway. Both manipulations significantly increase the uptake of cholesterol in the organ of Corti.

Conclusion: Our study indicates that IHCs and OHCs can take up cholesterol from the extracellular medium via the endolysosomal pathway and in quantitative relation to their cellular cholesterol needs. This supports our hypothesis of an active, regulated cholesterol homeostasis in the organ of Corti.

Development of earphone-type noninvasive auditory prostheses with infrared laser-based technology

Yuta Tamai¹, Miku Uenaka², Aya Okamoto², Keito Hosokawa², Shizuko Hiryu², Kohta I. Kobayasi²

¹University of Tübingen, Neurobiology of Social Communication, Department of Otolaryngology-Head and Neck Surgery, Hearing Research Centre, University of Tübingen, Medical Center, Elfriede-Aulhorn-Strasse 5, 72076 Tübingen, Germany

²Doshisha University, Neuroethology and Bioengineering, Graduate School of Life and Medical Sciences, Doshisha University, Kyotanabe, Kyoto, Japan

Cochlear implants were widely used for the hard of hearing individuals, while at the same time, conventional cochlear implants have several limitations attributed to electrical stimulation restriction (i.e., the need for surgical implantation damaging residual hearing caused by the complication). Infrared laser stimulation is gaining attention as a possible alternative to electric stimulation because laser stimulation can activate the spatially selective area of the cochlea from the outer ear; therefore, it is possible to develop an earphone-type auditory prosthesis, which can improve speech comprehension by combining laser-evoked perception with residual hearing like electro-acoustic stimulation in cochlear implants. The purpose of this study was to examine the feasibility of infrared laser stimulation from the outer ear through the investigation of the laser-evoked perception using classical conditioning in head-fixed Mongolian gerbils (*Meriones unguiculatus*). A click-train of 4000 Hz (sound pressure level: 70 dB SPL) or a repetitive pulsed infrared laser irradiation (duty cycle: 0.4; radiant energy 11.7 mJ/cm² per pulse) to the lateral side of the cochlea from the ear canal through a tympanic membrane were presented as a conditioned stimulus for a reward (a drop of water). Licking behavior was recorded as a conditioned response. After the training, gerbils showed licking responses to the conditioned stimulus without paired water. In the test session following the training, white noise (sound pressure level: 35, 50, 65, 80, 95 dB SPL) was presented as a masking stimulus during the auditory and laser stimulation period. In addition, laser stimulation with various intensities (0.1 to 13.2 mJ/cm² per pulse) was presented to the subjects trained on auditory stimulation. As a result, laser-evoked licking behavior decreased with the masking stimulus intensified as auditory-evoked licking behavior did. The laser irradiation induced the licking behavior in the auditory-trained gerbils with an intensity-dependent manner; stimulus generalization was observed. In a subsequent experiment, simultaneous stimulation of auditory and laser stimulation with low intensity successfully elicited the auditory cortical response and licking behavior; however, auditory and laser stimulus alone could not induce an observable neural and behavioral response. These results suggest that the infrared laser irradiation to the cochlea can evoke auditory perception. A simultaneous combination of auditory and laser stimulation elicits greater auditory perception than the auditory and laser stimulus alone. This research will be an essential step for the clinical application of earphone-type noninvasive auditory prostheses with infrared laser-based technology.

Imaging auditory processing in crickets using extracellular loading of Ca²⁺ tracers

Berthold Hedwig¹, Xinyang Zhang¹, Darron Cullen², Fernando Montealegre-Z²

¹University of Cambridge, Department of Zoology, Downing Street, CB2 3EJ Cambridge, United Kingdom

²University of Lincoln, Department of Zoology, Brayford Way, LN6 7TS Lincoln, United Kingdom

Polar calcium indicators like Oregon Green Bapta-1 can be introduced electrophoretically into the insect nervous system through the sheath of ganglia or nerves using surface electrodes. Here we explored this technique to label auditory sensitive neurons in the cricket brain and also in the hearing organ of crickets and bush-crickets in order to image sound evoked fluorescent responses generated by the Ca²⁺ indicator. Ca²⁺-signals are picked up with a sensitive cooled CCD camera, attached to a compound microscope.

To study auditory processing in the brain, surface electrodes are used to deliver the dye into the anterior frontal auditory neuropil, which houses the axon terminals of the ascending auditory interneurons and of local interneurons involved in auditory pattern recognition. Dye delivery labels the population of auditory neurons and in some cases the corresponding cell bodies after sufficient diffusion time. Acoustic stimulation with pulse patterns derived from the cricket calling song pattern, activates neurons in the auditory neuropil and elicits sound evoked changes in the fluorescent signal. We aim to reveal details of the spatial organisation of auditory processing in the brain.

Auditory processing in the hearing organ is explored by iontophoretically labelling the auditory nerve and allowing the dye to diffuse into the crista acustica. Due to their black cuticle crickets require a challenging dissection of the hearing organ for imaging. However, some species of bush-crickets come with an almost transparent cuticula, which allows visualisation of the hearing organ in the intact animal. We successfully can label the auditory organ with indicators and now look forward to detect sound evoked Ca²⁺-signals in the auditory afferents, which are tonotopically arranged in the crista acustica.

Impact of conventional neonicotinoid insecticides and a novel alternative on auditory processing in the desert locust *Schistocerca gregaria*

Marcelo Christian¹, Michelle Kraft¹, Paul Wilknitz¹, Manuela Nowotny¹, Stefan Schöneich¹

¹Friedrich Schiller University Jena, Institute for Zoology and Evolutionary Research, Erbertstr. 1, 07743 Jena, Germany

Since market introduction in the 1990's, neonicotinoids became the most widely used class of insecticides worldwide. Their advantage in respect to previously used pesticides is that they act selectively as agonists at the nicotinic acetylcholine receptor (nAChR) of insects and show a much lower toxicity in vertebrates. However, the soaring agricultural use over the last decades is suspected to be one factor contributing to the worrying decline of pollinators and other non-target insects. Therefore, in 2018 the EU started to ban outdoor use of the most prominent neonicotinoids, which may now be replaced by supposedly more 'bee-friendly' insecticides with a similar mode of molecular interaction, such as the butanolide Flupyradifuron. Low to moderate activation of the nAChR by neonicotinoids cause nervous stimulation by increasing the postsynaptic excitation in cholinergic pathways, whereas high excitation levels overstimulate and eventually block the action potential generation in the postsynaptic neurons.

Here we investigated the impact of the classical neonicotinoids Imidacloprid and Clothianidin as well as the emerging alternative Flupyradifuron on the auditory processing in the locust. We simultaneously recorded the neural responses of sensory afferents from the ear (auditory nerve recording) and ascending interneurons (neck connective recording) to different sound pulses (1, 2, 10, 20 and 30 kHz; at 35 - 80 dB SPL in steps of 5 dB). While recording, we replaced the haemolymph surrounding the CNS with Ringer's solution containing successively increasing concentrations (10^{-13} - 10^{-3} M) of the respective insecticide.

In short summary: our experimental data indicate that in the locust all three insecticides do not directly affect the signal transduction and spike generation of the sensory cells in the ear but disturb and finally disrupt the subsequent synaptic processing in the primary auditory neuropil of the thoracic ganglia in a similar dose-dependent manner. 1) Spontaneous background spiking activity increased significantly in the neck connectives after application of 10^{-6} - 10^{-5} M solution of either drug, and dropped significantly for higher insecticide concentrations. The strongly increased general spiking activity in the CNS was also accompanied by seemingly uncoordinated muscle twitching in the animal's body. 2) The spike responses of auditory interneurons in the neck connective did not increase for the lower concentrations (10^{-13} - 10^{-7} M), but gradually declined for 10^{-6} - 10^{-5} M and were completely abolished at higher concentrations. 3) With the muscle twitching and general increase of background activity in the neck connective at 10^{-5} M, we recorded a temporary reduction of the neural responses in the auditory nerve that recovered at higher concentrations as soon as the background spiking in the connective dropped again.

From our study we conclude that in orthopteroid insects, that rely on auditory information for predator avoidance and/or intraspecific acoustic communication, sublethal intoxication by neonicotinoids may have a significant negative impact on their biological fitness by reducing their chances for survival and/or reproduction.

The potassium channel Eag contributes to variance adaptation in primary auditory neurons of *Drosophila melanogaster*

Julian Rafael Rottschäfer¹, Jan Clemens¹

¹European Neuroscience Institute, Neural Computation and Behavior, Grisebachstraße 5, 37077 Göttingen, Germany

Adaptation is common to many sensory systems and an important aspect of perception. While the strength and speed of adaptation has been described in many systems, its molecular and biophysical basis is often unknown.

Here, we sought to identify molecules contributing to adaptation in the fly's primary auditory neurons. The sound receiver of the fly is a feathery appendage of the antenna, called the arista, which vibrates in response to sound. Sound-induced antennal vibrations activate antennal mechanosensory neurons - the so-called Johnston's organ neurons (JONs) - which act as the primary auditory neurons. These auditory JONs adapt to two features of antennal movement: the mean - correcting for the baseline of antennal displacement - and the variance - correcting for the magnitude of antennal displacement or the sound intensity.

To identify molecules supporting mean or variance adaptation in JONs, we characterized the adaptation dynamics in fly mutants for 15 candidate genes using extracellular recordings. Candidate molecules included ion channels, motor proteins, and proteins involved in adaptation of other sensory systems.

We find that the strength and speed of variance adaptation is reduced in mutants of Ether a go-go, a voltage gated rectifying potassium channel. Adaptation is weaker when the CaM binding domain of Eag was mutated, implying that calcium increases Eag function via Calmodulin. Notably, mutations in eag have no effect on mean adaptation - variance and mean adaptation are thus implemented via separate mechanisms.

In conclusion, our results reveal the Eag channel as a key player in variance adaptation in fly hearing.

Optogenetic stimulation reduces spectral spread of cochlear implants – a modeling study

Lakshay Khurana^{1,2,3,4,5}, Daniel Keppeler^{1,3,4}, Lukasz Jablonski^{1,2,4}, Tobias Moser^{1,2,3,4,6}

¹University Medical Center Göttingen, Institute for Auditory Neuroscience, Robert-Koch-Str. 40, 37075 Goettingen, Germany

²German Primate Center, Auditory Neuroscience and Optogenetics Laboratory, Goettingen, Germany

³Max Planck Institute for Multidisciplinary Sciences, Auditory Neuroscience & Synaptic Nanophysiology, Goettingen, Germany

⁴University Medical Center Goettingen, InnerEarLab, Department of Otolaryngology, Goettingen, Germany

⁵University of Goettingen, Goettingen Graduate Center for Neurosciences, Biophysics, and Molecular Biosciences (GGNB), Goettingen, Germany

⁶University of Goettingen, Cluster of Excellence "Multiscale Bioimaging: from Molecular Machines to Networks of Excitable Cells" (MBExC), Goettingen, Germany

Electrical cochlear implants (eCIs) are the most successful neuroprosthetic devices, having partially restored hearing in about a million people worldwide. The eCI users, though obtain good speech perception in quiet environments, struggle to understand speech-in-noise and to appreciate music. This limitation is majorly caused by the wide spread of current in the cochlea which leads to broad neural excitation and limits the number of perceptually different channels. A possibility to reduce the spectral spread and to increase the number of independent channels is to advance towards optogenetic cochlear implants (oCIs). This project aims to assist the development of clinical oCIs by predicting the light spread in a human cochlea using an optical ray-tracing model. A reconstructed 3D cochlea model was imported to an optical engineering software to do an *in silico* investigation of the light spread. Ten light emitters were placed in the scala tympani, and simulated with different radiation profiles. The spectral spread was approximated from irradiance profiles in the Rosenthal's canal housing the somata of spiral ganglion neurons. The results showed that emitters having Gaussian profile (LASER-coupled waveguides) provide higher irradiance and lower spectral spread than those having Lambertian profile (LEDs). The spectral spread using optical stimulation was found to be lower than that with electrical stimulation. The emitter-to-neurons distance and orientation, and formation of scar tissue, impacted the irradiance, highlighting directions for development of oCIs and of soft surgery maintaining cochlear health. The modeling results strengthen the idea that oCIs would offer lower spectral spread than eCIs.

Paralemmin-3 – an essential constituent of the plasma membrane of auditory hair cells

Victoria Christine Halim^{1,2,3}, Iman Bahader^{1,2}, Thomas Effertz^{1,2}, Kathrin Kusch^{1,2}, Nicola Strenzke^{1,2}, Manfred Kilimann⁴, Christian Vogl^{1,2,5}

¹University Medical Center Göttingen, 37075 Göttingen, Germany

²Institute for Auditory Neuroscience, 37075 Göttingen, Germany

³Göttingen Graduate Center for Neurosciences, Biophysics, and Molecular Biosciences, 37075 Göttingen, Germany

⁴Max Planck Institute for Multidisciplinary Sciences, 37075 Göttingen, Germany

⁵Medical University Innsbruck, 6020 Innsbruck, Austria

*equal contribution

The exquisite sensitivity of mammalian hearing in part depends on active mechanical sound amplification in the cochlea. On the cellular level, this process is moderated by the electromotility of cochlear outer hair cells (OHCs) and relies on the interplay of (i) the motor protein prestin – a transmembrane protein present in the OHC plasma membrane that mediates voltage-dependent longitudinal elongation or contraction of the OHC lateral membrane – and (ii) the presence of a submembraneous actin/spectrin-based cortical lattice that translates forces into changes in cell length and stiffness. Here, we identified paralemmin-3 (Palm3) as a new molecular constituent of the lateral wall of inner hair cells (IHCs) and OHCs in the organ of Corti, indispensable for hair cell biology and hearing. Auditory brainstem recordings (ABRs) of *Palm3*-KO mice revealed early-onset and progressive hearing impairment with attenuated distortion product otoacoustic emissions (DPOAEs), suggesting corrupted cochlear amplification and a functional deficit in the peripheral auditory pathway. On a morphological level, confocal and light-sheet microscopy data from intact cochleae or acutely dissected organs of Corti of *Palm3*-KO mice revealed progressive and extensive loss of OHCs along the tonotopic axis. This loss was apparent as early as 2 weeks of age. In addition, surviving OHCs as well as IHCs displayed disturbed hair cell shapes. In OHCs, Palm3 displays a subcellular distribution very similar to that of prestin and – analogous to *Prestin*-KO mice – OHCs of *Palm3*-KO mice also exhibited a significant reduction in cell length and displayed disturbed prestin and KNCQ4 distributions. In sensory IHCs, absence of Palm3 led to a decrease in afferent synapse counts within the basolateral region. Moreover, the abundance of large-conductance (BK) K⁺ channel clusters, which have a characteristic distribution in the IHC neck region, was drastically reduced. In summary, Palm3 is essential for the cell shape, stability and survival of OHCs and IHCs, and for the domain distribution of multiple membrane proteins within the hair cell plasma membrane.

Quantification of cochlear neurons based on light sheet microscopy

Anupriya Thirumalai^{1,2,3}, Tabea Quilitz^{1,2,5}, Antoine Huet^{1,2,3,5,6,7}, Tobias Moser^{1,2,4,5,6,7}

¹Institute for Auditory Neuroscience, University Medical Center Göttingen, 37075 Göttingen, Germany;

²InnerEarLab, University Medical Center Göttingen, 37075 Göttingen, Germany;

³Auditory Circuit Lab, University Medical Center Göttingen, 37075 Göttingen, Germany;

⁴Department of Otolaryngology, University Medical Center Göttingen, 37075 Göttingen, Germany;

⁵Cluster of Excellence "Multiscale Bioimaging: From Molecular Machines to Networks of Excitable Cells,"; University of Göttingen, 37075 Göttingen, Germany;

⁶Auditory Neuroscience and Optogenetics Laboratory, German Primate Center, 37075 Göttingen, Germany;

⁷Synaptic Nanophysiology Group, Max Planck Institute for Biophysical Chemistry Göttingen, Germany;

Hearing is of critical importance for our daily life. Hearing impairment is the most common sensory deficit of humans with disabling hearing impairment affecting half a million people (WHO). Hearing impairment most often arises from dysfunction or loss of sensory hair cells, while cochlear neurons (spiral ganglion neurons, SGNs) typically remain and can be directly activated by cochlear implants (CI). Both for current electrical CIs and future optogenetic CIs, the availability of SGNs is critical and the efficacy of (opto)genetic approach depends on the fraction of Channelrhodopsin-expressing SGNs achieved.

This calls for quantification of the total number of SGNs and the fraction of Channelrhodopsin-expressing SGNs. Since each cochlea contains thousands of SGNs, here we worked on a workflow using volume imaging by lightsheet fluorescence microscopy (LSFM) and automated SGN counts.

We had previously worked on the quantitative analysis of SGNs using semi-automatic seed finding and watershed-based algorithm implemented in arivis Vision4D (Arivis AG) software and their density distribution along the Rosenthal's canal using Avizo(Thermo Fisher Scientific Inc). There we faced several challenges and still required a considerable amount of man power. (Keppeler et al.,2021)

In the present study, we aimed to overcome those challenges worked towards a novel approach based on machine learning for segmentation. This employed the software packaged stardist, that uses convolutional neural network to densely predict cells as star-convex polyhedron (Schmidt et al.,2018; Weigert et al.,2020). We will present the methods and first results our study.

Reconstitution of synthetic ribbon-type active zones in a heterologous system: in pursuit of dissecting the molecular organization and dynamics of *presynaptic* Ca²⁺ channels.

Rohan Kapoor^{1,2,3,4}, Niko Schwenzer^{4,6}, Thomas Dresbach⁵, Tobias Kohl^{4,6}, Stefan Lehnart^{4,6}, Tobias Moser^{1,2,3,4}

¹Institute for Auditory Neuroscience and InnerEarLab, University Medical Center Göttingen, Göttingen, Germany

²Auditory Neuroscience and Nanophysiology Group, Max Planck Institute of Multidisciplinary Sciences, 37075 Göttingen, Germany

³International Max Planck Research School for Molecular Biology, University of Göttingen, Göttingen, Germany

⁴Multiscale Bioimaging Cluster of Excellence, University of Göttingen, Göttingen, Germany.

⁵Institute for Anatomy and Embryology, Synaptogenesis Group, University Medical Centre Göttingen, Germany

⁶Cellular Biophysics and Translational Cardiology, University Medical Centre Göttingen, Germany

Cochlear inner hair cell synapses have specialized electron dense structures called synaptic ribbons, which tether a halo of synaptic vesicles in close proximity to the presynaptic active zone (AZ) for fast, precise and tireless neurotransmission, essential for hearing. The synaptic ribbon has also been proposed to act as a super-scaffold organizing the topography of voltage-dependent calcium channels (type Ca_v1.3) and vesicular release sites (Frank et al. 2010, Khimich et al. 2005, Maxeiner et al. 2016, Jean et al. 2018, Neef et al., 2018). Using a bottom-up synthetic biology approach, we attempt to reconstitute ribbon-type AZs in HEK293 cells to probe how the synaptic ribbon, via intermediate AZ protein interaction partners (bassoon, RIM-BP2 etc.) potentially regulates calcium channel assembly and physiology. By co-expressing the ribbon scaffold protein ribeye and a membrane-targeted bassoon with a palmitoylation consensus sequence at its N-terminus, we observe defined protein clusters at the plasma membrane, which strikingly resemble IHC ribbons in size and morphology. In addition, we co-expressed RIM-BP2 that is known to interact with Ca_v channels (Davydova et al. 2014; Krinner et al., 2017; 2021). The function of these synthetic ribbon synapses has been studied via patch clamp and calcium imaging. For analysis of the morphology of the synthetic ribbon synapses, we further employ MINFLUX nanoscopy and analysis by electron microscopy. Beyond synthetic synaptic biology in non-neuronal HEK293 cells, we perform further investigation in neuroendocrine (PC12) cells, which provide endogenous expression of several AZ components.

Sensitivity tuning of *Drosophila* Hearing

Philip Hehlert¹, Thomas Effertz², Ruo-Xu Gu³, Bert De-Groot³, Dirk Beutner², Martin C. Göpfert¹

¹University Goettingen, Cellular Neurobiology, Julia-Lermontowa-Weg 3, 37077 Goettingen, Germany

²InnerEarLab, Department of Otorhinolaryngology, Head and Neck Surgery, University of Göttingen, Germany

³Max Planck Institute for Multidisciplinary Sciences, Göttingen, Germany

Sensitive hearing in *Drosophila* requires the mechano-electrical transduction (MET) channel NOMPC (TRPN1). The N-terminus of NOMPC consists of 29 ankyrin repeats (ARs) that assemble into a helical structure, the AR-domain. The ARs tether the channel intracellularly to microtubules and are crucial for mechano-gating. As the *Drosophila* auditory system can be described by a simple gating spring model we tested if alterations in the AR-domain affect NOMPC's gating properties.

Consistent with previous reports, duplication of the AR-Domain (AR+AR-NOMPC) enabled mechano-activated currents in heterologous expression systems. The mechano-sensitivity of these MET currents resemble those of native NOMPC, and AR+AR-NOMPC restored sensitive hearing *nompC* knock out flies, while nonlinear gating compliance was found unaltered. Hence, duplicating the NOMPC AR-domain neither affects NOMPC mechano-sensitivity in *in vitro* nor *in vivo*.

Our findings suggests that the NOMPC AR-domain is rather in series with more compliant elements whose deformation promotes mechano-gating. Using molecular dynamics simulations and genetic manipulations, we narrowed down a highly compliant domain of NOMPC that possesses the required properties.

Sound processor and driver for optical cochlear implants enabling behavioural experiments in freely moving animals

Lukasz Jablonski^{1,2,3,11,12}, Tamas Harczos^{1,2,11}, Gerhard Hoch^{1,2,3}, Tobias Moser^{1,2,3,4,5,13}

¹Institute for Auditory Neuroscience, University Medical Center Göttingen (UMG), Göttingen, Germany

²Auditory Neuroscience and Optogenetics Laboratory, German Primate Center (DPZ), Göttingen, Germany

³InnerEarLab, University Medical Center Göttingen, Göttingen, Germany

⁴Auditory Neuroscience and Synaptic Nanophysiology Group, Max Planck Institute for Multidisciplinary Sciences, Göttingen, Germany

⁵Cluster of Excellence "Multiscale Bioimaging: from Molecular Machines to Networks of Excitable Cells" (MBExC), University of Göttingen, Göttingen, Germany

¹¹ equal contribution

¹² presenting author (lukasz.jablonski@wp.eu)

¹³ corresponding author (tmoser@gwdg.de)

In case of deafness, cochlear implants (CIs) bypass dysfunctional or lost hair cells by direct stimulation of tonotopically organised spiral ganglion neurons (SGNs) which convey auditory inputs to the brain. The state-of-the-art implants, electrical CIs (eCIs), enables speech understanding in the quiet in most of the approximately 1 million users worldwide and hence are considered the most successful neuroprostheses. However, due to wide spread of SGN activation from each out of 12 to 24 eCI electrode contacts (depending on manufacturer), coding of spectral information is very limited resulting in poor speech understanding in background noise as well as reduced music appreciation. Thanks to the ability to confine light in space, optical CIs (oCIs) combined with optogenetics promise to overcome this shortcoming of eCIs by enabling at least two times more independent stimulation channels. This requires fast and power-efficient real-time sound analysis and control of multiple microscale light emitters. Here, we present a low-weight (8 g), battery-powered, and wireless-controlled sound processor and driver for multichannel oCIs and its sister eCI system. These systems support behavioural experiments in freely moving rodents (e.g. rats) or non-human primates (e.g. marmosets) for assessing auditory percepts of the optogenetic stimulation and comparison off efficacy with electrical stimulation. This proof-of-concept multichannel oCI system paves the way for the future development of medical devices for human patients.

The Role of Vision for Frequency Discrimination and Path Integration in an Active Listening Paradigm

Annalena Malzacher^{1,2}, Tobias Hilbig³, Michael Pecka¹, Dardo N. Ferreiro^{1,4}

¹Division of Neurobiology, Faculty of Biology, Ludwig-Maximilians-Universität München, Munich, Germany

²TUM School of Life Sciences, Technical University of Munich, Freising-Weihenstephan, Germany

³Department of Computer Science and Mathematics, HM Munich University of Applied Sciences, Munich, Germany

⁴Department of General Psychology and Education, Ludwig-Maximilians-Universität München, Munich, Germany

Our recently established Sensory Island Task for humans (SITh) has proven to be a promising active sensing paradigm to study auditory perception in freely navigating humans (Ferreiro et al., 2022). It enables investigation of the ability of subjects to distinguish changes in the pitch of sounds (i.e., frequency discrimination thresholds) by navigating freely and intuitively within a 3 x 3 meter arena in search for an auditory target island. Sound presentation (i.e., heard frequency) is modulated online and depends on the subject's location in the arena. The target island location, which is randomly located across trials, elicits the playback of the target frequency.

We found that frequency discrimination thresholds determined in SITh match those measured using traditional, stationary, forced-choice paradigms. Moreover, subjects developed stereotypical search patterns which correlated with their musical experience and affected their frequency discrimination performance. Here, in a follow-up study, we set out to investigate the dependence of frequency discrimination performance, strategy choice, and navigation on the amount of available visual input.

We studied two task versions. In the 'binary' version, subjects are asked to find a target island located within a 3 x 3 meter arena. The target island is the only location of the arena which elicits the playback of the target frequency (500 Hz), which can be easily distinguished from the non-target frequency (850 Hz). In the 'gradient' version, rather than two distinct frequencies, a radial frequency gradient (including the previous binary frequencies) is presented across the arena.

We tested performance of normal-hearing young adult subjects in both SITh task versions under three different visual conditions: (1) control (normal, unaltered visual input), (2) scrambled visual input, (3) no visual input. After each trial, subjects were also required to indicate the location of the trial's starting point by taking two steps towards it. With this, their ability to navigate the arena and orient themselves during their search was measured.

Our data indicates that frequency discrimination thresholds under different levels of vision restriction tend to be lower with less visual input. Thresholds were indicated by the last frequency subjects heard when finishing a gradient trial, i.e., when they were convinced that the sound they heard matched the frequency of the target tone. The average sighted performance (control) matches our previous results and available literature, i.e., discrimination thresholds below 5%. Interestingly, thresholds tended to further improve without visual input. This tendency is more pronounced in subjects with more musical training. Surprisingly, while the subjects' path integration performance, quantified by their ability to correctly indicate the direction of the starting point at the end of trials, was affected by the quality of the visual input, it appears to be similar between SITh binary and gradient versions.

Towards behavioral evaluation of a multichannel optogenetic cochlear implant

Bettina Julia Wolf^{1,2,3}, Lukasz Jablonski^{1,2,3}, Tamas Harczos^{1,2}, Alexander Dieter^{1,2,3},
Christian Dullin^{4,5}, Patrick Ruther^{6,7}, Tobias Moser^{1,2,3,8,9}

¹Institute for Auditory Neuroscience, University Medical Center Göttingen, Göttingen, Germany

²Auditory Neuroscience and Optogenetics Laboratory, German Primate Center, Göttingen, Germany

³InnerEarLab, University Medical Center Göttingen, Göttingen, Germany

⁴Institute for Diagnostic and Interventional Radiology, University Medical Center Göttingen, Göttingen, Germany

⁵Clinic for Diagnostic and Interventional Radiology, Heidelberg University Hospital, Heidelberg, Germany

⁶Department of Microsystems Engineering (IMTEK), University of Freiburg, Freiburg, Germany

⁷BrainLinks-BrainTools, Cluster of Excellence, University of Freiburg, Freiburg, Germany

⁸ Auditory Neuroscience and Synaptic Nanophysiology Group, Max Planck Institute for Multidisciplinary Science, Göttingen, Germany

⁹ Cluster of Excellence "Multiscale Bioimaging: from Molecular Machines to Networks of Excitable Cells" (MBExC), University of Göttingen, Göttingen, Germany

Optogenetic cochlear implants (oCI) promise to overcome the issue of large current spread of electrical cochlear implants (eCI). However, the expected enhanced frequency resolution of an oCI has so far been shown in physiological experiments but not yet on the behavioral level. In order to evaluate the perceived selectivity of acoustic, electrical, or optical stimulation of the cochlea we established wireless multichannel e/oCI systems and used them in freely moving rats performing an auditory-cued avoidance task.

The ShuttleBox, a negative reinforcement paradigm encouraging avoidance behavior, was used to train Wistar rats (n=20) on click detection or pure tone discrimination tasks. Subsequently, animals were deafened via kanamycin injection and implanted either with a multichannel eCI (MED-EL electrode array with up to 5 electrodes) or a multichannel oCI (up to 10 LEDs). The position of the implant was confirmed via in vivo CT scan. Animals for oCI implantation had been injected with adeno-associated viruses carrying the channelrhodopsin-2 variant CatCh under the synapsin promoter at the age of 6–7 days. Functional expression of opsins was verified by recording optically evoked auditory brainstem responses (oABRs) prior to oCI implantation. Using the head-worn wireless CI system, animals were first subjected to a detection task via wireless triggered communication from outside the ShuttleBox inducing electrical or optical stimulation of the cochlea. Secondly, the CI system was used to directly process sounds and transform them into electrical/optical stimuli. To control that rats responded to CI stimulation instead of sound, deafness was confirmed via acoustic ABR (aABR) and behavior sessions with switched off CI system.

Functional expression of CatCh was confirmed in 87.5% of virus injected rats. Rats carried the CI system without any obvious burden. All animals pre-trained for detection also showed an avoidance behavior when cued by stimulation of the CI system (eCI, n=8; oCI, n=6). This was also true when acoustic clicks were transformed to stimuli using the CI system, instead of an external trigger. As expected, performance dropped to guessing level, when the CI system was switched off in control sessions. Using all available stimulation contacts mean behavioral thresholds were $\sim 75 \mu\text{A}$ for eCI and $\sim 0.8 \text{ mW}$ for oCIs. For both implant types behavioral responses could be elicited using a single stimulation site. So far, for discrimination experiments an acoustic mean frequency differentiation limen of 0.08 Weber fraction was identified.

We established multichannel e/oCIs systems enabling their comparison in freely moving rats. We demonstrated that the single LED-driven optogenetic stimulation evoked perception and is strong enough to elicit behavior in deaf animals. From here we aim to test the hypothesis of a higher spatial selectivity of optogenetic stimulation vs. electrical stimulation on the behavior level using established setup.

VGLUT3-Dependent Glutamatergic Quantal Transmission in Peripheral Vestibular Function

Mohona Mukhopadhyay¹, Aizhen Yang-Hood², Kevin K. Ohlemiller², Maolei Xiao², Mark Warchol², Mark Rutherford², Tina Pangrsic³

¹University Medical Centre Goettingen, Inner Ear Lab, Robert Koch Strasse 40, 37075 Goettingen, Germany

²Department of Otolaryngology – Head and Neck Surgery, Washington University School of Medicine, St. Louis, MO, USA

³Experimental Otology Group, InnerEarLab, Department of Otolaryngology, University Medical Center Göttingen, and Institute for Auditory Neuroscience, Göttingen, Germany; Auditory Neuroscience Group, Max Planck Institute for Multidisciplinary Sciences, Göttingen, Germany; Collaborative Research Center 889, University of Göttingen, Göttingen, Germany; Multiscale Bioimaging Cluster of Excellence (MBExC), University of Göttingen, Göttingen, Germany

The vesicular glutamate transporter family (VGLUTs) is imperative to the process of vesicular glutamate packaging, the neurotransmitter responsible for quantal transmission at most excitatory synapses. While VGLUT1 and VGLUT2 dominate such synapses, the inner ear is enriched with the third known isoform, vesicular glutamate transporter 3 (VGLUT3). This is a key player in the synaptic transmission occurring at the inner hair cell afferent synapses in the cochlear organ of Corti. Conceivably, the genetic deletion of *Vglut3* leads to loss of synaptic activity and congenital deafness in mice. VGLUT3 is known to be prevalent in the vestibular tissue, yet no overt vestibular dysfunction was reported in these mice. The peripheral vestibular system in the amniotes performs its functions by a highly organized interplay of quantal and nonquantal neurotransmission, the latter being restricted to the specialized synapses between the type I hair cells and the calyces. Quantal transmission at the vestibular synapses was found to be glutamatergic, as physiologically evidenced by the abolition of such transmission by AMPA blockers. We, therefore, set out to investigate the vestibular phenotype of *Vglut3* knockout mice using *ex vivo*- and *in vivo*- physiology experiments, behavioral studies, and immunohistochemistry. In our study, a global *Vglut3* knockout in mice yields no behavioral balance deficits, yet we observe nearly a complete lack of quantal activity at the calyceal synapses at the postnatal age of 2-3 weeks. The possibility of compensation by the other subtypes i.e., VGLUT 1 or 2, was ruled out due to their considerably low expression levels in the wild-type mice and no detectable upregulation in the *Vglut3*-deficient VHCs. The lack of balance deficits, therefore, suggests that an alternative mechanism of neurotransmission, i.e., nonquantal transmission, might be largely responsible for the normal functioning sense of balance in mice.

Poster Topic

T18: Auditory System: Subcortical and Cortical Processing

- [T18-1A](#) Age-related synaptopathy alters central auditory responses to speech-like stimuli in the rat
Lukas Rüttiger, Anna Melchers, Konrad Dapper, Etienne Gaudrain, Deniz Baskent, Marjoleen Wouters, Sarah Verhulst, Matthias H.J. Munk, Marlies Knipper
- [T18-2A](#) Distinct Neural Populations Process Auditory and Non-Auditory Activity in Shell Inferior Colliculus
Gunnar Lennart Quass, Meike Marie Rogalla, Alexander Nicholas Ford, Kaiwen Shi, Pierre François Apostolides
- [T18-3A](#) Dopamine dependent potentiation of auditory evoked potentials in the striatum
Andreas L Schulz, Michael T Lippert, Frank W Ohl
- [T18-4A](#) Even small changes in acoustic background can induce prepulse inhibition of the startle response depending on size and direction of change
Lisa Koch, Eva Dunkel, Markus M. Middeke, Bernhard H. Gaese
- [T18-5A](#) GABA_B Receptors modulate the membrane potential of neurons in the dorsal nucleus of the lateral lemniscus.
Amina Javadova, Felix Felmy
- T18-6A Retracted
- [T18-7A](#) How the Brain Detects Important Sounds: Deviance Detection in Auditory Brainstem Responses
Johannes Wetekam, Julio Hechavarria, Luciana Lopez-Jury, Manfred Koessl
- [T18-8A](#) Implications of synaptic noise on excitation-inhibition integration in auditory brainstem neurons
Jonas Martin Fisch, Eckhard Friauf
- [T18-9A](#) Frequency integration in the intermediate nucleus of the lateral lemniscus is based on a biophysically heterogeneous cell population.
Kathrin Deborah Wicke, Nikolaos Kladisios, Felix Felmy
- [T18-1B](#) Morphology and physiology of the Mongolian gerbil anteroventral cochlear nucleus neurons.
Sabina Nowakowska, Jana Henseler, Antoine Tarquin Huet
- [T18-2B](#) Neuromodulation of the endbulb of Held to Bushy Cell synapse in the anteroventral cochlear nucleus by serotonin and norepinephrine.

Theocharis Alvanos, Maria Groshkova, Tobias Moser

- [T18-3B](#) Neuronal Integration of Acoustic Signals in an Insect Auditory System
Annette Stange-Marten, Jan Scherberich, Stefan Schöneich, Melisa Merdan-Desik, Manuela Nowotny
- [T18-4B](#) Phase coupling is crucial for positive threshold effect in tinnitus patients
Konstantin Tziridis, Holger Schulze
- [T18-5B](#) *Phyllostomus discolor* Retain a Consistent Beam Size in Seeking Targets
Ravi Umadi, Lasse Jakobsen, Lutz Wiegrebe, Uwe Firzlaff
- [T18-6B](#) Potential functions of local and descending auditory neurons in a bush cricket
Ali Cillov, Andreas Stumpner
- [T18-7B](#) Representation of auditory space in the shell of the inferior colliculus
Meike Marie Rogalla, Gunnar L Quass, Deepak Dileepkumar, Alexander N Ford, Gunseli Wallace, Harry Yardley, Pierre F Apostolides
- [T18-8B](#) Robust Frontal Spatial Representations Appear in the Auditory Cortex of Awake Mice
Michael Hideki Myoga, Matthias Gumbert, Benedikt Grothe
- [T18-1C](#) Species-specific morphometry of structural compartments of MNTB principal neurons
Christina Pätz-Warncke, Tjard Bergmann, Sönke von den Berg, Felix Felmy
- [T18-2C](#) Stimulus-specific adaptation in the bat's frontal and auditory cortex
Eugenia Gonzalez-Palomares, Julio C. Hechavarria
- [T18-3C](#) Target resolution of single neurons in the computational target distance map of bats
Ali Roustazadeh, Uwe Firzlaff
- [T18-4C](#) The role of Otoferlin at the inner hair cell synapse: An In vitro investigation
Mehar Monga, Julia Preobraschenski
- [T18-5C](#) The TSC – mTORC1 axis in the development of the auditory brainstem
Lena Ebbers, Jan Bobrowski, Enno Davide Wendlandt, Lisa Borowsky, Kathrin Thedieck, Hans Gerd Nothwang
- [T18-6C](#) The two-pore potassium channel subunit Task5 regulates central auditory processing
Christoph Körber, Mahshid Helia Saber, Michaela Kaiser, Lukas Rüttiger
- [T18-7C](#) Weak topographic organization of auditory corticocollicular neurons
Kira Maria Anna Andrea, Tatjana T. X. Schmitt, Simon L. Wadle, Jan J. Hirtz
- [T18-8C](#) What factors influence the speed of task learning in a freely moving go/no-go paradigm?
Gökce Dogu, Valentin Winhart, Paula Gundi, Andrey Sobolev, Miguel Bengala, Dardo N. Ferreira,

Michael Pecka

Age-related synaptopathy alters central auditory responses to speech-like stimuli in the rat

Lukas Rüttiger¹, Anna Melchers¹, Konrad Dapper¹, Etienne Gaudrain^{2,3}, Deniz Baskent³, Marjoleen Wouters⁴, Sarah Verhulst⁴, Matthias H.J. Munk⁵, Marlies Knipper¹

¹University of Tübingen, Tübingen Hearing Research Centre, Elfriede Aulhorn Str. 5, 72076 Tübingen, Germany

²Lyon Neuroscience Research Center, CNRS UMR5292, Inserm U1028, Université Lyon 1, Lyon, France

³Department of Otorhinolaryngology, University Medical Center Groningen (UMCG), Hanzeplein 1, BB21, 9700 RB Groningen, The Netherlands

⁴Dept. Information Technology, Ghent University, Technology Campus, iGent, Technologiepark 126, 9052 Zwijnaarde, Belgium

⁵Department of Psychiatry & Psychotherapy, University of Tübingen, Calwerstraße 14, 72076 Tübingen, Germany

In the mammalian inner ear, cochlear inner hair cells connect to the brain via a multitude of exclusive spiral ganglion neurons within the auditory nerve. Over the lifetime, a large number of these connections are lost even without traumatic events from e.g. like noise, or ototoxic medication. This condition is called cochlear synaptopathy, a condition in which the numbers of cochlear hair cells – inner and outer hair cells – remain unaffected and audiometric hearing thresholds (audiograms) as well as cochlear amplification by outer hair cells (otoacoustic emissions) seem normal in the clinical testing. However, coding for sound levels and the temporal resolution are most likely to be impaired in the situation of synaptopathy. It is a matter of debate whether also speech understanding will be disturbed cochlear synaptopathy.

We examined the hearing performance of three groups of laboratory rats of different ages, young (1-4 months, average ca. 2.2 months), middle aged (10-19 months, average ca. 13 months), and old (20-30 months, average ca. 25 months). We used auditory brainstem responses (ABR) to analyze hearing thresholds and activation of the auditory nerve (ABR wave I) and the ascending auditory pathway (ABR wave II, III, and IV) by quantifying response amplitudes and latencies for a variety of frequency and level specific auditory stimuli (click, noise-burst, and pure-tone pips). Outer hair cell function was tested by otoacoustic emission (DPOAE) threshold, amplitude and growth. Testing auditory steady-state responses (ASSR) and fast adaptation of DPOAEs (MOC reflex) the time resolution of the ascending auditory responses and efferents were tested, respectively. On a subgroup of rats of either age, we presented speech-related short syllable stimuli with contrasts for steady-state vowels (/i/–/y/; /o/–/u/) and consonants (/di/–/bi/; /du/–/bu/) to test the discrimination of low and high frequency contrasts for onset and steady state auditory stimuli.

The lifetime progression of the hearing deficits in the rat matched well with the observations, which have long been described for several rodent animal models. The data confirm that synaptopathy and auditory fibre loss takes place long before the loss of hair cells may become obvious. The changes in audiometric thresholds with age are subtle, even in the old-aged rats. However, temporal resolution, dynamic range coding, and the central brain responses to auditory, complex speech-like sounds alter in the aging rat in a specific way.

We present data in the rat, that illustrate the interrelationships between peripheral and central auditory processing, as they may be relevant for cognitive tasks required in speech perception in the human. We intend to further investigate the relevance of our results from the rat experiments for language comprehension in humans in behavioural experiments on animal models.

Acknowledgment and funding

This work was supported by the Deutsche Forschungsgemeinschaft DFG KN 316/13-1, DFG RU 713/6-1, NEURON JTC 2020, BMBF 01EW2102 CoSySpeech

Distinct Neural Populations Process Auditory and Non-Auditory Activity in Shell Inferior Colliculus

Gunnar Lennart Quass¹, Meike Marie Rogalla¹, Alexander Nicholas Ford¹, Kaiwen Shi¹,
Pierre François Apostolides^{1,2}

¹Kresge Hearing Research Institute, Department of Otolaryngology, University of Michigan Medical School

²Department of Molecular and Integrative Physiology, University of Michigan Medical School

Active listening requires not only correctly identifying primary sound features, but also predicting their behavioral relevance, or in other words, perceptual learning. Behaviorally relevant representations are often seen in auditory cortex and medial geniculate, but whether this activity can be found earlier in the pathway remains unclear. The non-lemniscal nuclei of the inferior colliculus (shell IC) receive a variety of acoustic, multi-sensory and neuromodulatory signals, suggesting an integrative role in perceptual learning. We thus asked whether behavior and/or outcome signals are present in the shell IC during an auditory task, and whether neurons changed their responses to stimuli once they gained behavioral relevance, using long-term Ca²⁺-imaging, machine learning, and a reward-based discrimination task in mice.

The Ca²⁺-indicator GCaMP6f was expressed in shell IC neurons of 11 CBA/C57 BL/6J mice who were trained to detect the presence of amplitude modulation in a bandpass noise stimulus using a GO/NOGO paradigm. Using 2-photon microscopy, we recorded the responses of the same dorsal shell IC neurons to these stimuli over several weeks, first in a passive condition, and subsequently during task acquisition. Once mice had become experts, modulation depth was varied to obtain psychometric functions. We analyzed the population- and individual activity during the process of learning as a whole and at various epochs during psychometric trials, and used a support vector machine (SVM) classifier to predict several behavioral and acoustic variables from neural population activity.

Our data show that neurons shift their responses from sound-responses to outcome-responses during task acquisition. We further found that the average differences in neural population trajectories and principal components during correct and incorrect responses stabilized over time, suggesting that representations of task-related variables are robust in the shell IC. We predicted the outcome of each trial from the neural data using an SVM classifier. Significant classification was achieved even if activity was integrated over only the first or second half of the sound stimulus, and even when the SVM was exclusively trained on neural activity occurring prior to mice's behavioral response. Collectively, our data argue that neural population activity in the auditory midbrain encodes behavioral relevance of sounds, and reflects a mixed selectivity of predictive- and feedback information about behavioral outcome in response to behaviorally relevant sound features.

Supported by NIH R01DC019090, The Whitehall Foundation, and the Hearing Health Foundation.

Dopamine dependent potentiation of auditory evoked potentials in the striatum

Andreas L Schulz¹, Michael T Lippert¹, Frank W Ohl^{1,2}

¹Leibniz Institute for Neurobiology, Department Systems Physiology of Learning, Brenneckestr 6, 39118 Magdeburg, Germany

²Otto-von-Guericke-University Magdeburg, Institute for Biology, Leipziger Straße 44 / Haus 91, 39120 Magdeburg, Germany

The cortico-striatal pathway is involved in the transformation of auditory representations into decision-making and consequently into motor commands. Learning of an auditory discrimination task potentiates cortico-striatal synapses. It remains unknown so far, whether dopamine is necessary for plastic changes of these synapses. To assess the role of dopamine on these synapses, we employed gerbils in a passive listening task with frequency modulated tones and paired tone presentations with optogenetic stimulation of the ventral tegmental area (VTA). We recorded local field potentials in two different sites in the striatum, in the posterior and in the dorsal lateral striatum. The magnitude of the auditory evoked potentials (AEP) in the striatum were increased after VTA stimulation in the dorsal striatum, but not in the posterior striatum. Systemic application of a dopamine antagonist prevented the increase of the AEP and tend to be even smaller after VTA stimulation. Magnitude of AEP without VTA stimulation did not change. In summary, dopamine seems to be required for the increase of striatal AEP and consequently for potentiation of auditory striatal synapses, however in the current study we did not distinguish between possible pathways, like cortico-striatal or thalamo-striatal connections.

Even small changes in acoustic background can induce prepulse inhibition of the startle response depending on size and direction of change

Lisa Koch¹, Eva Dunkel¹, Markus M. Middeke¹, Bernhard H. Gaese¹

¹Goethe University Frankfurt, Institute of Cell Biology and Neuroscience, Max-von-Laue-Str. 13, 60438 Frankfurt am Main, Germany

Investigating the ability to discriminate stimulus levels or frequencies in rodents mostly requires time-consuming training of animals. Here we explored the possibilities of applying a reflex-based behavioral method for a time-efficient measurement of discrimination abilities.

The acoustic startle response is elicited in response to sudden loud acoustic stimuli with reflexive contraction of skeletal muscles. A preceding weaker acoustic stimulus can reduce the startle response amplitude, a phenomenon called prepulse inhibition (PPI). This procedure does not require training of animals. We tested rats in a modified behavioral paradigm combining a continuous background stimulus with a shift in frequency or stimulus level acting as a startle-modifying prepulse (= shift-prepulse). For a thorough characterization of these paradigms, three parameters were systematically changed: i) frequency of background stimulation, ii) step size and direction of shifts and iii) timing of the shift-prepulse. For investigating level changes, step sizes up to ± 15 dB were tested, starting from background levels of 65 and 75 dB SPL, respectively. Frequency shifts were tested in the range of $\pm 30\%$ at background frequencies of 8 and 16 kHz.

Change-induced PPI increased with change size for both, frequency and stimulus level shifts. Maximal inhibition depended in both cases on background frequency, with strongest inhibition occurring at the lowest frequency tested (8 kHz). Level shifts starting from a background of 65 dB SPL yielded significantly lower inhibitions than shifts from 75 dB SPL. Level increases led to significantly higher inhibition values than level decreases. Frequency shifts were tested with different timings of the shift-prepulse. Highest inhibition values were found for shift-prepulses clearly separated from the startle stimulus (80 ms shift duration, starting 130 ms before startle pulse) compared to shift-prepulses lasting until the start of the startle pulse. Depending on timing and background frequency, different thresholds for eliciting a significant inhibition were found with lowest thresholds as small as $\pm 2\%$ for 8 kHz for shift-prepulses starting 130 ms before the startle pulse, lasting 130 ms and 80 ms. Contrary to the findings for level shifts, no effect of shift direction was found in the frequency shift paradigm.

In summary, the modified acoustic startle response is a fast, reliable and promising measure for the characterization of perceptual and detection thresholds. This could be applied to investigate suprathreshold hearing deficits after acoustic trauma. Further research into the neuronal basis of prepulse processing should be conducted by combining behavioral with electrophysiological measurements.

GABA_B Receptors modulate the membrane potential of neurons in the dorsal nucleus of the lateral lemniscus.

Amina Javadova¹, Felix Felmy¹

¹Institute of Zoology, University of Veterinary Medicine Hanover, Germany

The dorsal nucleus of the Lateral Lemniscus (DNLL) is an auditory brainstem structure within the binaural circuits. One known function of DNLL neurons is their role in the suppression of spurious sound source information. These GABAergic neurons from both hemispheres are reciprocally connected and feed-forward their inhibition to the inferior colliculus. The mechanism and function of the GABA_A receptor-dependent signaling in this circuit is well understood. Next to GABA_A receptor signaling, GABA_B receptor-dependent modulation is documented at various other auditory brainstem structures. However, the presence, mechanism, and function of GABA_B receptor signaling in GABAergic DNLL neurons are unclear.

To first determine the presence of GABA_B-receptors in the DNLL, we immunofluorescently labeled GABA_B-receptor1 subunits in Mongolian gerbils of postnatal days 10 and ~30. GABA_B-receptors were present at the soma and visible part of the proximal dendrite of DNLL neurons in both ages. To assay the functionality of these receptors, we puff applied Baclofen to DNLL neurons in acute brain slices while recording the membrane potential and currents. In both age groups, baclofen hyperpolarized the cell membrane and generated an outward current. The hyperpolarization reduced the action potential generation. Mechanistically voltage-gated potassium channels likely mediate this hyperpolarization. Because the application of tetraethylammonium suppressed the baclofen-mediated hyperpolarization, while cesium did not.

Taken together, our data demonstrate the presence and functionality of GABA_B-receptors in DNLL neurons before and after hearing onset. In these neurons, postsynaptic GABA_B modulation of the membrane potential is mediated by potassium channels and can lead to action potential suppression.

How the Brain Detects Important Sounds: Deviance Detection in Auditory Brainstem Responses

Johannes Wetekam¹, Julio Hechavarria¹, Luciana Lopez-Jury¹, Manfred Koessler¹

¹Institute of Cell Biology and Neuroscience, Goethe University, Frankfurt, Auditory Computations Group (Kössl, Hechavarria), Max-von-Laue-Str. 13, 60438 Frankfurt am Main, Germany

The ability to detect unexpected acoustic cues in an environment of repetitive sounds is of major importance for animals. The neural correlate of this ability is called deviance detection and describes a change in neural response strength that is solely caused by the stimulus' probability of occurrence. Former studies could demonstrate the presence of deviance detection in both animals and humans across different areas of the brain. However, most of these studies focussed on higher-order stations of the auditory system, like the cortex and thalamus, while less is known about the role lower stations play in the processing of acoustic probability-encoding. In a previous study, we measured non-invasive auditory brainstem responses (ABRs) in the bat species *Carollia perspicillata*, a hearing specialist, and could demonstrate that frequency-dependent deviance detection is already present at the level of the brainstem. Based on this observation, the current study aims to further advance our knowledge of low-hierarchy deviance detection in mammals. To this end, we (1) continued the ABR-recordings in bats but increased the stimulus-complexity (natural vocalisations instead of pure tones) to mimic more natural situations for the animal. Additionally, we (2) tackled the question how fast the brainstem adapts to a repetitive sequence of stimuli, a prerequisite for deviance detection. The results demonstrate that the brainstem is able to encode probabilities of complex stimuli and help to characterise low-hierarchy deviance detection and with this improve our understanding of the phenomenon as a whole.

Implications of synaptic noise on excitation-inhibition integration in auditory brainstem neurons

Jonas Martin Fisch¹, Eckhard Friauf¹

¹Technische Universität Kaiserslautern, Animal Physiology, Erwin-Schrödinger-Straße 13, 67663 Kaiserslautern, Germany

Integration of multiple synaptic inputs is a hallmark of inter-neuronal information processing, and excitatory-inhibitory integration is utterly important in lateral superior olive (LSO) neurons, enabling sound localization. A given LSO neuron receives convergent input from ~40 weak excitatory input fibers from the ipsilateral cochlear nucleus (CN). By contrast, only ~4 strong inhibitory fibers converge from the medial nucleus of the trapezoid body (MNTB; Gjoni et al. 2018; (doi.org/10.1113/JP276012), Müller et al. 2019 (doi.org/10.1113/JP277757)). Differences in interaural sound pressure level (ILD) and temporal disparities (ITD) are integrated in the CN → LSO ← MNTB circuit. 'Class 3 excitability', i.e., phasic firing in response to step current injection, is often seen in other auditory neurons, accompanied by a sensitivity against the rate of depolarization. Adding noise to excitable systems influences the output considerably by creating slope-based stochastic resonance (Gai et al. 2010; doi.org/10.1371/journal.pcbi.1000825). Physiologically, noise arises from 1) temporal jitter of converging inputs and 2) noise in the strength of these inputs. The influence of rate-sensitivity and integration of synaptic noise in mature LSO neurons is unknown. This motivated us to combine dynamic-clamp experiments with modeling of input spiking patterns to analyze ILD and ITD integration in these important sound localization neurons.

Using in-vitro whole-cell recordings, we stimulated mouse LSO principal (pLSO) neurons with sinus-amplitude-modulated (SAM) currents. Next, we performed dynamic-clamp experiments to analyze the effects of non-linear currents evoked by conductance injections and their contribution to the rate-sensitivity. Finally, we used computational modeling to create temporal jitter in input spiking. Each spiking pattern was convolved to time-varying conductances using a unitary synaptic conductance template. Summed excitatory and inhibitory conductances thus simulate the convergent inputs from CN and MNTB neurons to a pLSO neuron. This scenario allows to analyze the effects of synaptic noise on output generation and the sensitivity of LSO neurons to virtual sound paradigms. Stimulating phasic pLSO neurons with SAM currents revealed a strong sensitivity to the rate of depolarization. Current threshold was lowest at 200-500 Hz, with a logarithmic mean of ~270 Hz for P30-40 mice. Similar results were obtained at >P60, with a mean of ~240 Hz. SAM conductances increased the minimal frequency at which LSO neurons generated spikes. Adding synaptic noise (temporal jitter) to the conductance was insufficient to evoke spikes in response to low-frequency SAM stimuli.

Taken together, our study shows that phasic LSO neurons are sensitive to the rate of depolarization, creating a band-pass filter for temporal integration. Noise in synaptic excitation is filtered by leaky LSO neurons and provides no further coding information. Spikes occur only when temporal jitter by modeled input fibers is low, emphasizing the importance of enhanced phase-locking by CN neurons. Ongoing experiments will reveal whether noise through synaptic inhibition extends the range of ILD and ITD integration.

Frequency integration in the intermediate nucleus of the lateral lemniscus is based on a biophysically heterogeneous cell population.

Kathrin Deborah Wicke¹, Nikolaos Kladisios¹, Felix Felmy¹

¹Institute of Zoology, University of Veterinary Medicine Hannover, Germany

Cross-frequency processing is considered to generate important information about the acoustic environment. Yet, sound frequencies are mostly represented tonotopically organized in the auditory brainstem pathways, an organisation principle insufficient to explain frequency perception. The intermediate nucleus of the lateral lemniscus (INLL) might be a suitable candidate for cross-frequency integration, as a fraction of INLL neurons have already been suggested to be involved in this task. So far, the biophysical, synaptic and morphological features of this neuronal population remain largely uncharacterized.

We use *in vitro* whole-cell recordings to characterise INLL neurons, their synaptic inputs and label recorded neurons to recover their location and three-dimensional morphology. Additionally, *in vivo* single unit recordings were performed to investigate frequency integration using a two-tone paradigm.

The passive and active membrane properties and firing behaviours of INLL neurons display a vast heterogeneity. This heterogeneity correlates with a continuum of membrane time constants (τ_{mem}) that is based on differences in input resistance. The biophysical differences are not regional specific and do not indicate any connections to possible tonotopic arrangements in the INLL. Morphological features of single neurons do not correlate with biophysical properties, indicating a lack of cellular structure-function relationship and the importance of the expression patterns of voltage gated ion channels. The time course and paired pulse ratios correlate with τ_{mem} . Finally, *in vivo* recordings indicate that a two-tone paradigm, where best-frequency tone is paired with a second tone, leads to a shift in frequency tuning in about a third of INLL neurons. This shift in frequency tuning indicates that INLL neurons do not have a static tuning curve, and frequency integration prevails at this auditory structure.

Our data shows that the neuronal population in the INLL exhibits a biophysical heterogeneity creating a wide continuum of integration time scales. Since no special organisation principle could be observed the temporal integration appears not to be bound to a strict anatomically defined tonotopy. The shift in frequency tuning indicates that this population rather provides a substrate of continuous temporal integration times serving to process sounds in the frequency domain.

Morphology and physiology of the Mongolian gerbil anteroventral cochlear nucleus neurons.

Sabina Nowakowska^{1,2,3}, Jana Henseler^{1,3,4}, Antoine Tarquin Huet^{1,2,3,5}

¹Auditory Circuit Lab, Institute for Auditory Neuroscience, University Medical Centre Göttingen, Robert-Koch-Str. 40, D-37075 Goettingen, Germany

²Multiscale Bioimaging Cluster of Excellence, University Medical Centre Göttingen, Robert-Koch-Str. 40, D-37075 Göttingen, Germany

³Auditory Neuroscience Group, Max Planck Institute for Multidisciplinary Sciences, Am Fassberg 11, 37077 Göttingen, Germany

⁴Else Kröner Fresenius Stiftung, Geschäftsstelle Bad Homburg v.d.H. Louisenstraße 120, 61288 Bad Homburg v.d.H

⁵Auditory Neuroscience and Optogenetics Laboratory, German Primate Center, Kellnerweg 4, 37077, Göttingen, Germany

In response to low frequency sounds, the firing of the auditory nerve fibres (ANFs) is synchronised to the period of the sound - a property named phase-locking. The ANFs send excitatory inputs to the anteroventral cochlear nucleus (AVCN). The postsynaptic neurons in this area of brainstem display improved precision and entrainment of the phase-locking¹. Nonetheless, the underlying integration mechanisms are still unclear. Neurons of AVCN are organised tonotopically and have been grouped into different types based on their morphology² and pattern of physiological responses to short burst pure tones³. Most of this literature is based on cats (*Felis catus*), however, a model of growing importance in hearing research is Mongolian gerbil (*Meriones unguiculatus*). So far, similar mapping of the AVCN has not been performed in gerbils in great detail⁴. Using sharp micropipettes, we recorded *in vivo* from the gerbil's AVCN single unit responses to acoustic stimulation and characterised a wide range of units. Additionally, we analysed the morphology and the number of excitatory inputs of the AVCN neurons along the tonotopic axis. Our results will lay foundation for next experiments interrogating the mechanism of the augmentation of temporal code in AVCN using optogenetic stimulation of the auditory nerve fibers^{5,6} and recently established *in vivo* single unit recordings in the brainstem.

References:

1. Joris, P. X., Carney, L. H., Smith, P. H. & Yin, T. C. Enhancement of neural synchronization in the anteroventral cochlear nucleus. I. Responses to tones at the characteristic frequency. *J. Neurophysiol.* 71, 1022–1036 (1994).
2. Osen, K. K. Cytoarchitecture of the cochlear nuclei in the cat. *J. Comp. Neurol.* 136, 453–483 (1969).
3. Pfeiffer, R. R. Classification of response patterns of spike discharges for units in the cochlear nucleus: Tone-burst stimulation. *Exp. Brain Res.* 1, 220–235 (1966).
4. Ryan, A. F., Woolf, N. K. & Sharp, F. R. Tonotopic organization in the central auditory pathway of the mongolian gerbil: A 2-deoxyglucose study. *J. Comp. Neurol.* 207, 369–380 (1982).
5. Wrobel, C., Dieter, A., Huet A.T., Keppeler, D., Duque-Afonso, C.J., Hoch, G., Jeschke, M., Moser, T. Optogenetic stimulation of cochlear neurons activates the auditory pathway and restores auditory-driven behavior in deaf adult gerbils. *Sci. Transl. Med.* 10, eaao0540 (2018).
6. Mittring, A., Moser, T. & Huet, A. T. Graded optogenetic activation of the auditory pathway for hearing restoration. 2022.09.05.506618 Preprint at <https://doi.org/10.1101/2022.09.05.506618> (2022).

Neuromodulation of the endbulb of Held to Bushy Cell synapse in the anteroventral cochlear nucleus by serotonin and norepinephrine.

Theocharis Alvanos^{1,3,4,6}, Maria Groshkova^{1,5,6}, Tobias Moser^{1,2,3,6}

¹Auditory Neuroscience and Synaptic Nanophysiology Group, Max Planck Institute for Multidisciplinary Sciences, Fassberg Campus, 37077, Göttingen, Germany

²Cluster of Excellence "Multiscale Bioimaging: from Molecular Machines to Networks of Excitable Cells" (MBExC), University of Göttingen, 37075, Göttingen, Germany

³Collaborative Research Center SFB 1286 "Quantitative Synaptology", University of Göttingen, 37075, Göttingen, Germany

⁴International Max Planck Research School for Neurosciences and Göttingen Graduate Center for Neurosciences, Biophysics, and Molecular Biosciences (GGNB), University of Göttingen, 37075, Göttingen, Germany

⁵International Max Planck Research School for Molecular Biology, University of Göttingen, 37075, Göttingen, Germany

⁶Institute for Auditory Neuroscience and Inner Ear Lab, University Medical Center Göttingen, 37075 Göttingen, Germany

While chemical synaptic transmission in most CNS synapses is mediated by a conserved cocktail of presynaptic proteins, a profound variability of synaptic strength has been described between different circuits and even among neurons of the same subtype. This is also true for calyceal synapses of the auditory pathway that are endowed with high synaptic vesicle (SV) release probability (P_{vr}) and large postsynaptic currents leading to temporally precise firing. Neuromodulation of the large endbulb of Held terminals by Norepinephrine (NE) and Serotonin (5-HT) is a promising candidate mechanism to shape and also tune synaptic transmission and its variability across synapses, potentially changing how temporal information is processed in the lower auditory pathway.

We initially gathered immunohistochemical evidence for the presence of 5-HT – and NE – releasing varicosities in the AVCN, juxtaposed to both endbulbs and Bushy cells (BCs), by staining against their respective transporters. The expression of different modulator receptor subtypes at endbulbs and BCs was tackled with immunohistochemistry to seek out the different associated G-protein pathways that could be active in the pre- and postsynaptic compartments of the synapse. We then voltage clamped mouse BCs at physiological temperature and recorded miniature EPSCs (mEPSCs) and evoked endbulb EPSCs before and after bath – application of 5-HT or NE. The exposure to neuromodulators led to shifts in both the kinetics and frequency of mEPSCs, as well as to changes in short – term plasticity, P_{vr} and recovery from readily releasable pool depletion compared to controls. To assess the effect of neuromodulators on the transfer of auditory information, we current clamped BCs and stimulated the afferent auditory nerve fibers that give rise to endbulbs. Our aim is to probe for changes in the latency of endbulb – evoked BC action potentials during pharmacological neuromodulation of the system.

The lower auditory pathway, thanks to its large calyceal synapses, provides a unique opportunity to understand presynaptic neuromodulation and changes in the equilibrium of SV docking, priming, fusion and endocytosis. At the same time, learning how short – term plasticity can be modulated in the endbulb will elucidate dynamic aspects of sound localization in different behavioural contexts and yield transferrable

hypotheses to study neuromodulation in other neuronal circuits.

Neuronal Integration of Acoustic Signals in an Insect Auditory System

Annette Stange-Marten¹, Jan Scherberich¹, Stefan Schöneich¹, Melisa Merdan-Desik^{1,2},
Manuela Nowotny¹

¹ Friedrich-Schiller-Universität Jena, Institut für Zoologie und Evolutionsforschung, Jena, Germany

² Goethe-Universität, Institut für Zellbiologie und Neurowissenschaften, Frankfurt am Main, Germany

Mechanoreceptors in hearing organs translate sound-induced mechanical responses into neuronal signals, which are processed and forwarded to the brain along a chain of neurons in the auditory pathway. In bushcrickets, axons of the sensory cells in the hearing organ, that is located in the front leg ears, project to the prothoracic ganglion, where the first-integration step takes place. There, a relatively small number of local and projecting interneurons process incoming signals to facilitate frequency spectrum analysis, temporal pattern recognition and directional orientation. During this first-integration step of neuronal signals, inhibition is well described in bushcrickets. However, information about advantage in processing during hearing about what is lost and what is gained is still missing.

Here, we systematically characterize in the bushcricket species *Mecopoda elongata* the neuronal processing at the level of sensory cells, the prothoracic ganglion as well as in ascending neurons projecting to the brain. We collected data about the temporal pattern of spiking along this auditory pathway and the impact of inhibitory interneurons. To this end, we measured extracellularly spiking of sensory neurons in the leg, the activity of the prothoracic ganglion using multielectrode arrays and the response of the neck connectives with hook electrodes during tonal and natural song stimulation. To gain access to the role of inhibition, we eliminated sensory input from the contralateral ear.

Our experiments reveal the timing sequence of spikes along the auditory pathway in bushcrickets from the sensory neuron to the neck, which connects to the brain. Specifically, from the ear to the neck about 14 ms are needed and spike numbers decrease. Furthermore, we show the spatio-temporal pattern of excitation within the prothoracic ganglion and in particular the impact of inhibitory interneurons projecting from the contralateral side. Interestingly, we found long-lasting increases in local field potential amplitudes, that point to amplification processes on the synaptic level. This may play a role during communication of *M. elongata* males with females.

Phase coupling is crucial for positive threshold effect in tinnitus patients

Konstantin Tziridis¹, Holger Schulze¹

¹University hospital Erlangen, ENT Hospital, Head and Neck surgery, Waldstrasse 1, 91054 Erlangen, Germany

Since the hypothesis of the development of tinnitus through a physiological mechanism for optimising the acoustic information flow into the central nervous system (stochastic resonance, SR) was established in 2016, we have been able to find numerous indications to prove this mechanism. One of them was based on the audiometric examination of nearly 40,000 patients of our ENT clinic with and without tinnitus, in which we were able to show that lower hearing thresholds were observed in patients with tinnitus than in patients without tinnitus, especially in the range below 3 kHz, which is important for understanding speech. In other words, in line with the prediction of our model, patients with tinnitus hear better than patients without tinnitus.

An essential component of our model are so-called delay-lines in the dorsal nucleus cochlearis, which are able to calculate the autocorrelation of the neuronal signal and thus quantify the information content transmitted into the auditory system. This in turn is used to optimise the stochastic resonance and thus the information transmission. Decisive for this information content in the signal is its temporal structure, which is expressed, for example, in the phase coupling of the neural to the acoustic signal. However, this phase coupling exists in mammals only up to a maximum frequency of around 5 kHz. Above this frequency, according to our hypothesis, no more optimisation of the information transmission and thus of the hearing threshold could take place.

Against the background of these considerations, we have now re-examined the above mentioned data and found that patients with tinnitus below 5 kHz have a significantly better hearing threshold across all frequency ranges than patients with tinnitus above this cut-off frequency. These latter patients even have significantly worse hearing thresholds than the patients without tinnitus. This finding is another strong indication that the phase coupling of the neuronal activity relevant for SR is responsible for the positive threshold effect and optimises the flow of information into the auditory system in the range up to 5 kHz.

***Phyllostomus discolor* Retain a Consistent Beam Size in Seeking Targets**

Ravi Umadi^{1,2}, Lasse Jakobsen³, Lutz Wiegrebe², Uwe Firzlaff¹

¹Lehrstuhl für Zoologie, TUM School of Life Sciences, Technische Universität München, Liesel-Beckmann-Str. 4, 85354 Freising-Weihenstephan, Germany

²Department Biologie II, Ludwig-Maximilians-Universität, Großhaderner Str. 2, 82152 Planegg, Germany

³Department of Biology, University of Southern Denmark, Campusvej 55, 5230 Odense, Denmark

Control and coordination of the geometric shape and the acoustic features of the sonar beam are a source of dynamic flexibility and adaptability for a foraging echolocator. In the wild, FM bats use a highly directional beam in the search phase to avoid clutter and enhance the range by adjusting the mouth gape. In the final approach, they broaden the beam by lowering the frequency for better trackability. Phyllostomids and Rhinolophids can achieve beam size variability via nostrils and nose leaf positioning. However, the beam dynamics during the active pursuit of an object of interest in the presence of competing objects are not well established. In this study, we did experiments in a virtual echo-acoustic environment under the oddball paradigm. The bats were required to search and find a rewarding deviant phantom echo among the non-rewarding background phantom echoes. The bats were trained to sit restrained on a platform, 1.9 m away, and probe via echolocation the space in front of them, where a 45-channel parabolic array of microphone and speaker assembly units provided us a means to generate and define the virtual echoes in real-time playback experiments. We collected and analyzed the audio data for two experimental conditions. The first condition simulated an open-ended search. The bats searched the array for a randomly assigned rewarding unit while the speakers were muted. We then employed the oddball paradigm where the deviant echo was either a temporally or spectrally modified playback of the calls. We reconstructed the sonar beam imprint for calls in search sequences and derived the dimensions of the beam at 3dB amplitude drop. A comparison of the variability in the beam sizes between the two experimental conditions showed clear differences in beam geometry. In the first condition, the

beam width and height ranged from 10 to 80 degree angles, and the beam area expanded to 4000 degree². In the oddball condition, the width and height of the beam centered around 40 ± 10 degrees, and the beam area was limited to around 1000 degree². The data also indicate a shift toward

constancy of beam dimensions in oddball search sequences; an initial random search presumably results in the identification of the target and prompts a constraint on the beam geometry. The call-frequency content analyses generally mirror the trend in beam geometry and could partly account for the changes in the beam size. As seen in the results from no playback conditions,

P. discolor can produce a broad range of beam dimensions, conceivably via a combination of call-frequency and nose-leaf morphology adjustments, aiding the myriad of navigational and foraging contexts. However, the results from the oddball condition demonstrate that beam size consistency might be a preferable strategy for active target pursuit in complex scenes to ease both the processing load and motor coordination of the emitter and receivers. Moreover, for a given beam size, spectral and intensity adjustments nonetheless grant flexibility.

Potential functions of local and descending auditory neurons in a bush cricket

Ali Cillov¹, Andreas Stumpner¹

¹University of Göttingen, Dept. Cellular Neurobiology, Julia-Lermontowa-Weg 3, 37077 Göttingen, Germany

Orthopterans have evolved acoustic communication at least two or three times independently. Though their auditory systems share similar units, different species also exhibit divergent evolutionary adaptations. A duetting bush cricket, *Ancistrura nigrovittata* (Phaneropteridae) has been studied in unprecedented detail. Males sing with a distinct temporal pattern at ca. 16 kHz and females respond with short delay and a click at ca. 28 kHz. The critical parameters for song recognition are known. Ascending neurons and T-fibres project to the brain, where important processing takes place – best studied so far for carrier frequency. The properties of the information relayed to the brain are based on local processing in the prothorax. Two of the four known local neuron types and most descending neurons (DNs) have not been studied in detail so far. Data from potentially homologous neurons in other bush crickets are either missing or fragmentarily distributed over different taxa. We describe local and descending neurons in *A. nigrovittata* and ask what their potential function in song recognition might be.

Our data from intracellular recordings and stainings show morphologically similar but physiologically diverse DN types including one type, which has a reduced descending axon making it a local neuron. Another local neuron not described in detail so far is similar in its temporal responses but mainly differs in directional dependence. Both types might serve as reference neurons for sound in general. Most DN types with more central projections respond to acoustic but not vibratory stimuli, while those with lateral projections respond also or nearly exclusively to vibration. We also report a neuron tuned to the male song frequency but also responsive to vibration, possibly participating in the switch from acoustic long-distance communication to acousto-vibratory short-distance communication.

Representation of auditory space in the shell of the inferior colliculus

Meike Marie Rogalla¹, Gunnar L Quass¹, Deepak Dileepkumar¹, Alexander N Ford¹,
Gunseli Wallace¹, Harry Yardley¹, Pierre F Apostolides¹

¹University of Michigan, Kresge Hearing Research Institute, Department of Otolaryngology-Head and Neck Surgery, Ann Arbor, Michigan, USA

Spatial hearing enables humans and animals to localize sounds in their vicinity, which contributes to survival. Unlike vision or touch, the peripheral auditory system lacks a spatial map at the sensory receptor level. Sound source location is therefore derived centrally from mainly binaural cues, as well as from monaural cues. In the case of unilateral hearing loss, binaural cues are no longer available, which limits spatial hearing. However, monaurally occluded humans and animals can regain sound localization following perceptual training. It is assumed that the observable re-learning of sound localization relies on the context-dependent re-calibration of auditory space representation by monaural cues. Thus, central experience-dependent auditory plasticity mechanisms must exist to re-calibrate sound localization circuits. The “shell” nuclei of the inferior colliculus (shell IC) are hypothesized to act as plasticity loci for sound localization cues. However, the neural population coding of spatial information in the mammalian shell IC remains poorly understood. We developed an acoustic delivery system to present sound stimuli from distinct spatial positions within the horizontal frontal field by moving a speaker around the animals’ head while performing cellular resolution 2-photon Ca²⁺-imaging in the shell IC of awake, head-fixed mice. We found that neurons in the murine shell IC are spatially tuned, and that the population coding follows a surprisingly different pattern as previously shown for other auditory regions: In contrast to the central IC, where spatial tuning shows a contralateral dominance, we found both contra- and ipsi-lateral selective neurons, such that a single hemisphere contained a representation of the entire horizontal field. Although previous data suggested a monotonic code for spatial representations in the mammalian auditory system, many shell IC neurons were tuned to discrete contra- and ipsi-lateral positions. Tuning required binaural integration and seems impervious to representational drift: tuning broadened or shifted towards the contralateral hemifield after inserting an ear plug into the left ear. To our knowledge, these results are the first insight into spatial population codes of the mammalian shell IC. Future studies will test if active engagement in a localization task is required for plasticity of spatial tuning during monaural hearing loss.

Robust Frontal Spatial Representations Appear in the Auditory Cortex of Awake Mice

Michael Hideki Myoga^{1,2}, Matthias Gumbert², Benedikt Grothe^{2,3}

¹Ludwig-Maximilians-Universität München, Biomedical Center, Department of Physiological Genomics, Großhaderner Str. 9, 82152 Planegg-Martinsried, Germany

²Max-Planck-Institut für Biologische Intelligenz (i.G.), Schaltkreise für Richtungshören, Am Klopferspitz 18, 82152 Planegg-Martinsried, Germany

³Ludwig-Maximilians-Universität München, Division of Neurobiology, Department Biologie II, Großhaderner Str. 2, 82152 Planegg-Martinsried, Germany

In the auditory system, the detection and perception of a sound's spatial location must be computed and processed entirely within the brain, as space is not mapped onto its sensory epithelium. In the auditory cortex (AC), initial studies of spatial tuning generally supported a model in which spatial information is represented in the relative firing rates of two opposing, hemispheric channels. However, these studies were performed exclusively under anaesthesia, and more recent psychophysical and electrophysiological studies in the awake AC have provided some evidence for a third, frontal channel. The confusion over the number of spatial channels represented in the AC stems at least in part from the lack of a direct comparison of individual neurons between wakefulness states.

We therefore employed longitudinal *in vivo* two-photon calcium imaging in the AC of CBA/CaJ mice with the genetically-encoded calcium indicator GCamp6s. A total of eight imaging sessions were performed (interleaved between four anaesthetized and four awake sessions). Spatial tuning was probed with a five-loudspeaker free-field array spanning 120 ° of horizontal angular space (30 ° ipsilateral to -90 ° contralateral), and analyses were performed on neurons that could be re-found on all sessions.

We found that spatial tuning between wakefulness states and across sessions was generally unstable, although the population under anaesthesia as a whole exhibited a robust contralateral bias, thus supporting the two-channel model of other studies using anaesthesia. However, in the awake state, a subpopulation of neurons became robustly tuned to the front of the animal. This subpopulation was remarkably stable, consisting of largely the same neurons across sessions. Interestingly, these neurons did not have stereotyped spatial tuning under anaesthesia. Many were actually non-responsive or not spatially tuned while anaesthetised.

Our findings thus provide direct evidence for a third, frontal spatial channel in the awake mouse AC. The precise manner in which anaesthesia specifically suppresses frontal tuning remains unclear, but recent reports of spatial tuning in the awake mouse inferior colliculus show no such robust frontal tuning, tempting us to speculate that it in fact arises *de novo* in the AC. Future studies promise further insights into the behavioural significance of frontal spatial tuning in mammals.

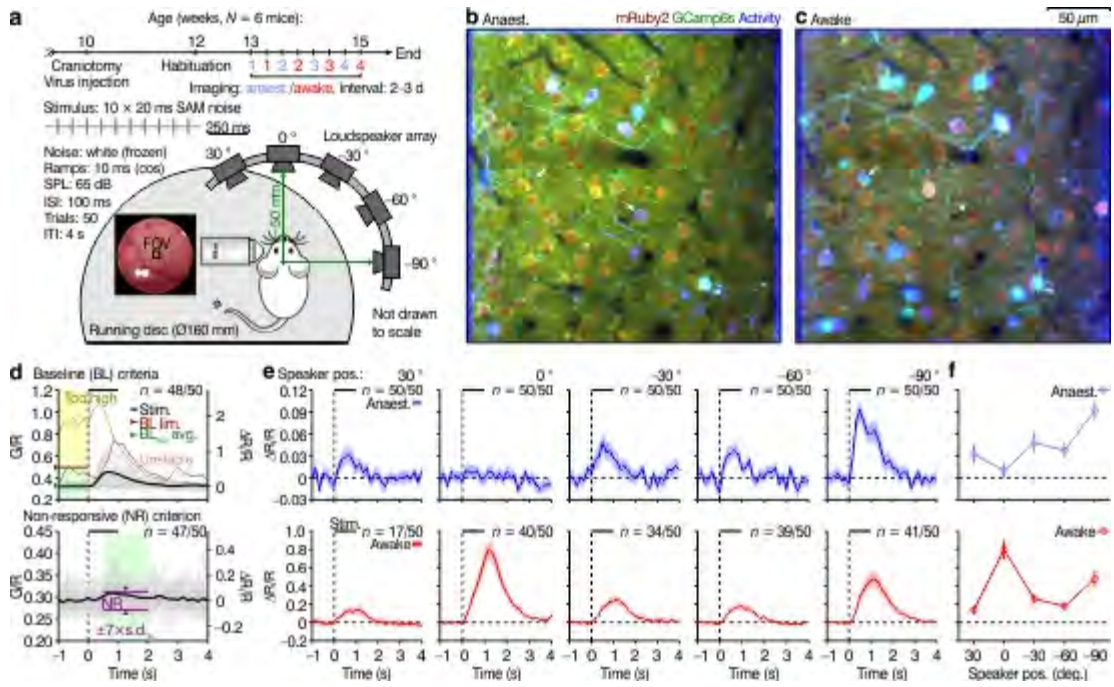

Species-specific morphometry of structural compartments of MNTB principal neurons

Christina Pätz-Warncke¹, Tjard Bergmann¹, Sönke von den Berg¹, Felix Felmy¹

¹Stiftung Tierärztliche Hochschule Hannover, Institut für Zoologie, Bünteweg 17, 30559 Hannover, Germany

Neurons in the medial nucleus of the trapezoid body (MNTB) are glycinergic globular cells, which precisely relay information to elicit a rapid feedforward inhibition. Since the MNTB can be addressed in all mammals investigated so far and its projection pattern is comparable across mammals, this circuit appears evolutionary highly conserved. At least in rodents, several cellular features including soma size are supposed to vary along the tonotopic axis of the MNTB. Although the input-output function of MNTB neurons is dominated by somatic excitation, the dendritic compartment of these neurons is implicated in action potential generation by additional sodium conductance and to serve as a current sink to accelerate EPSPs. Most of this detailed knowledge originates from mice and rats, while this structure exists in every mammal investigated so far. A detailed reconstruction and quantitative morphometry of the dendritic, somatic and initial axonal compartment of MNTB neurons and their species-dependency is lacking.

We used 3D reconstructions from single-cell electroporations to analyse the structure of individual MNTB neurons from five different species and performed immunofluorescence to determine soma and nucleus arrangement in a total of eight species. The examined species were mouse lemurs, tupaia, guinea pig, two bats, mouse, gerbil and Etruscan shrew. We find that average soma size strongly correlates with brain size. Soma size increases with tonotopic frequency only in tupaia, gerbil, mouse and Etruscan shrew, while it tends to decrease in both bat species and guinea pig. In all species, the dendritic compartment extends beyond the MNTB border defined by VGluT-positive calyx of Held terminals. Sholl analysis reveals dendritic distances from the soma of more than 200 μm even in Etruscan shrew. The longest dendritic distances from the soma are found in bat and gerbil. The average number of primary dendrites is lowest in bats and highest in gerbil. Only in gerbil the complexity and length of the dendritic arbour, its orientation and shape are correlated with the tonotopic frequency. The initial dendritic segment before the first branch point is shortest in Tupaia and longest in bat. Across species, the average diameter of the initial dendritic and axonal segment correlates with soma volume, suggesting an adjusted current sink coupling. Furthermore, dendritic and unexpectedly axonal compartments appear connected with glycinergic and glutamatergic synapses, judged by overlapping fluorescence of VGluT1 and GlyT2 labelling with the cellular marker.

Taken together, MNTB neurons possess large and complex dendrites, which receive different synaptic inputs. The detailed analysis shows species-dependent differences in MNTB arrangement and morphology of the somatic, dendritic and axonal compartment. These differences cannot generally be explained by differences in brain size, indicating species-dependent adaptations in this highly conserved brainstem structure.

Stimulus-specific adaptation in the bat's frontal and auditory cortex

Eugenia Gonzalez-Palomares¹, Julio C. Hechavarria¹

¹Goethe University Frankfurt am Main, Institute for Cell Biology and Neuroscience, Max-von-Laue-Str., 13, 60438 Frankfurt am Main, Germany

In humans, scream vocalizations have strong amplitude modulations (AM) at 30 to 150 Hz. These AM correspond to the acoustic correlate of perceptual roughness. In bats (species *Carollia perspicillata*), distress syllables also carry amplitude fluctuations at rates of approximately 1.7 kHz (> 10 times faster than in humans). The distress calls with these modulations are used more prominently by males and might signal a greater urgency, since they elicit larger heart rate increments than their demodulated versions. In order to study the neural processing of these two sounds (the distress calls with fast AM and the demodulated versions), we simultaneously recorded in two brain areas from the bat neocortex, the auditory cortex (AC) and the frontal auditory field (FAF), a frontal area responsive to sounds. We searched for stimulus-specific adaptation (SSA), which is described as the neuronal adaptation to a frequently presented stimulus (standard) yet responding strongly to an infrequent sound (deviant). The amplitude modulated natural calls and their demodulated forms were used as stimuli pairs. Our results show the existence of stimulus-specific adaptation in response to natural distress sounds produced by the bats. In addition, we describe that the dynamics of stimulus specific adaptation differs between frontal and auditory areas within the bat brain.

Target resolution of single neurons in the computational target distance map of bats

Ali Roustazadeh¹, Uwe Firzlaff¹

¹Technical University of Munich, Chair of Zoology, Liesel-Beckmann-Strasse 4, 85354 Freising

In the auditory cortex of echolocating bats, the distance to an object (target) is represented in a specialized neuronal map. Neurons in this map only fire action potentials if echoes are reflected from objects in the environment (e.g. insects or other prey items) and arrive with a specific delay after the bat has emitted a call. In contrast to structural maps, which simply reflect the topographic organization of the epithelial surface of a peripheral sensor, the map of target-distance is a computational map. The delay between call emission and echo arrival is computed within the neural circuitry of the bats' auditory system, and each neuron in the target distance map is tuned to a specific delay time.

Our experiments aim to investigate the representation of multiple objects in the computational target distance map of the bat *Phyllostomus discolor*. These objects are arranged along the same distance axis. Single-electrode extracellular recordings are employed to reveal the resolution along the distance axis i.e. the minimum distance between the objects that can be resolved by single delay-tuned neurons. For this purpose, a virtual target echo is combined with two virtual masker echoes, occurring with a shorter and a longer masker delay, thus simulating reflections from objects (maskers) positioned in front of and behind the virtual target. These maskers can be thought about as foliage in front of and behind the target that do not entirely occlude each other.

Preliminary results indicate that the presence of maskers diminishes the response to the call-target echo pair, even if they are presented with delays outside the range of call-echo delays that the neuron is tuned to. Therefore, the target distance resolution of single neurons cannot simply be inferred from the width of their delay-tuning functions.

The target-resolution thresholds will be compared to the data from the behavioral performance of bats in previous psychophysical experiments. This will answer the question if psychophysically measured target resolution can be explained solely based on the performance of single neurons, or if a larger population of neurons in the target distance map is needed to achieve the behaviorally measured resolution.

The role of Otoferlin at the inner hair cell synapse: An In vitro investigation

Mehar Monga^{1,2}, Julia Preobraschenski^{1,2}

¹Biochemistry of Membrane Dynamics, Institute for Auditory Neuroscience, University Medical Center, Göttingen

²MBExC Research Alliance 3.2

Neurotransmission at the auditory synapse differs from that at central nervous system synapses in its temporal fidelity, precision, and molecular machinery. These synapses are capable of ultrafast microsecond level precision, leading to faithful sound processing. The inner hair cells (IHCs) of the cochlea are the primary sensory organs for sound encoding, converting mechanical sound vibrations to neurotransmitter signal. The synaptic machinery governing SV exocytosis varies considerably from CNS synapses. Calcium triggered neurotransmitter release at the IHC synapse is perceived to be mediated by Otoferlin, a 227 kDa, membrane protein possessing seven C2 domains. Mice lacking the *Otof* gene are profoundly deaf; many missense mutations in the gene are known to cause auditory synaptopathy DFNB9 in humans. Multiple lines of evidence indicate that Otoferlin is involved in calcium mediated exocytosis, vesicle recycling and active zone replenishment. In vitro data suggest that isolated C2 domains of the protein bind calcium, and phospholipids.

However, till date, there are no in vitro studies characterizing the full length protein. Due to its size, the presence of a membrane anchor, and an unstable behavior in solution, it has been difficult to purify the protein. Therefore, the exact role of Otoferlin is largely unresolved. We have been working on elucidating the mechanism by which Otoferlin functions using bottom up reconstitution and structural approaches. We have succeeded in purifying functional Otoferlin. Furthermore, our data indicate a calcium, and phospholipid dependent stabilization for the protein. We are also working on predicting the structure of Otoferlin. To this end, we have tested multiple membrane mimics, including salipro nanodiscs, detergents, and liposomes. We have optimized grid freezing conditions for cryo-EM and collected some preliminary data, making headway into resolving the structure of Otoferlin, and identifying crucial calcium binding sites. Our next set of experiments involve probing the role of Otoferlin in SNARE mediated membrane fusion.

Given that missense mutations in Otoferlin can cause varying severity of deafness, we are also working with pathophysiologically relevant mutant Otoferlin constructs, identified by genetic screens and deafness associated databases. An analysis of the full length and mutant proteins in vitro would help us identify the central domains required to preserve protein function. This would be important in designing gene therapies to alleviate Otoferlin associated hearing impairment.

PRELIMINARY CHARACTERIZATION FOR OTOFERLIN

Ca²⁺ dependent stabilization

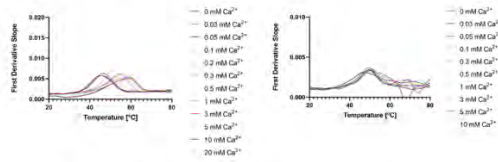

Effect of phospholipids on Ca²⁺ binding

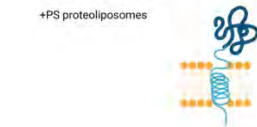
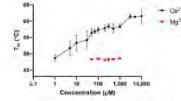
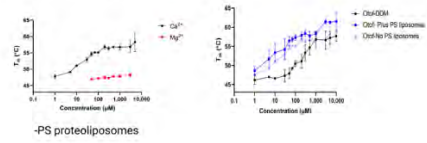

Preliminary characterization of full length and soluble Otoferlin constructs

The TSC – mTORC1 axis in the development of the auditory brainstem

Lena Ebbers¹, Jan Bobrowski¹, Enno Davide Wendlandt¹, Lisa Borowsky¹, Kathrin Thedieck², Hans Gerd Nothwang¹

¹Neurogenetics Division, Department for Neuroscience, Faculty VI - School of Medicine and Health Sciences, Carl von Ossietzky University Oldenburg, Germany

²Lab for Metabolic Signaling, Institute of Biochemistry and Center for Molecular Biosciences Innsbruck, University of Innsbruck, Austria

Mammalian/mechanistic target of rapamycin (mTOR) is a central determinant of cell metabolism, proliferation, differentiation and survival in virtually all organs. mTOR exists in two structurally and functionally distinct multiprotein complexes termed mTOR complex 1 (mTORC1) and mTOR complex 2 (mTORC2), which are embedded in a sophisticated kinase network mediating mTOR's multiple functional outputs.

In humans, mTORC1 hyperactivation is causative for tuberous sclerosis complex, a multisystem disorder characterized by benign tumors in multiple tissues including the brain. Neurodevelopmental manifestations include seizures, a developmental delay and autism spectrum disorder. In addition, mTORC1 hyperactivation is associated with auditory dysfunction in mice and humans.

To study central auditory aspects of mTORC1 dysregulation, we generated two genetically modified mouse lines by conditionally disrupting the mTORC1 suppressor *Tsc1* (leading to mTORC1 hyperactivation) or the mTORC1 component *Raptor* (leading to mTORC1 inactivation) in the auditory brainstem. The auditory brainstem is composed of a multitude of neuronal populations, which are organized in various interconnected nuclei, participating in fundamental auditory processing tasks including localization of sound sources and determination of sound duration.

Conditional *Tsc1* and *Raptor* knockout mice (*Tsc1^{Egr2}* and *Raptor^{Egr2}*, respectively) exhibit pronounced morphological disturbances of the cochlear nucleus complex (CNC) and the superior olivary complex (SOC), two major complexes of the auditory brainstem. In the *Raptor* deficient brainstem these centres were markedly reduced, whereas *Tsc1* ablation results in the opposing effect. Further analyses focusing on the medial nucleus of the trapezoid body (MNTB) in the SOC, revealed a significant increase in cell cross-section area in adult *Tsc1^{Egr2}* mice. In contrast, total MNTB cell number was significantly reduced. Analyses in neonatal mice showed a delayed assembly of the SOC nuclei as the MNTB was not discernible in *Tsc1^{Egr2}* mice at P0, pointing to a developmental delay of auditory brainstem structures. In adult *Raptor^{Egr2}* mice the MNTB was not detectable in Nissl stained sections. Immunohistochemical analyses revealed residual dispersed neurons in the MNTB area. These cells were innervated by small underdeveloped Calyces as shown by Vglut1 immunoreactivity.

To confirm that these alterations were due to disturbed mTORC1 activation we used phospho-S6 (pS6) as a read-out for mTORC1 activity. Indeed, pS6-positive cells in the auditory brainstem were significantly increased in *Tsc1^{Egr2}* and decreased in *Raptor^{Egr2}* mice.

In summary, our results point to a requirement of a balanced mTORC1 activity for proper development of the auditory brainstem. In addition, morpho-functional alterations in the auditory brainstem upon mTORC1 hyperactivity possibly contribute to auditory processing deficits in patients with tuberous sclerosis.

The two-pore potassium channel subunit Task5 regulates central auditory processing

Christoph Körber¹, Mahshid Helia Saber¹, Michaela Kaiser¹, Lukas Rüttiger²

¹Heidelberg University, Department of Functional Neuroanatomy, Im Neuenheimer Feld 307, 69120 Heidelberg, Germany

²University of Tübingen, Molecular Physiology of Hearing, Tübingen Hearing Research Centre, Department of Otolaryngology, Elfriede-Aulhorn-Strasse 5, 72076 Tübingen, Germany

Processing of precisely timed auditory signals critically depends on the neurons ability to fire brief action potentials (APs) at high frequencies for prolonged times. Information about the timing of signals is typically conveyed by neurons firing a single AP at the beginning of the stimulus (onset firing), thereby allowing for the persistence of timing information. This firing pattern is enabled by the expression of a specialized set of ion channels and the tight regulation of the neuronal excitability in these cells. Neuronal excitability is mainly set by two-pore potassium channels (K2P channels) that regulate the resting membrane potential (RMP). Of particular interest in auditory neurons is the K2P subunit Task5, which, in mouse, is expressed almost exclusively in the auditory brainstem nuclei. Task5 failed to form functional ion channels in heterologous expression systems and is thus known as a “silent” subunit. Here we show, using shRNA-mediated knock-down (KD) and knock-out (KO) of Task5, that Task5 plays an important role in the establishment of precisely timed, brief APs and onset firing pattern. Moreover, we demonstrate that Task5 KO mice show deficits in high frequency, high fidelity synaptic transmission at the endbulb of Held synapse in the cochlear nucleus and in the processing of sounds that are either loud or in the high frequency range above 16 kHz.

Weak topographic organization of auditory corticocollicular neurons

Kira Maria Anna Andrea¹, Tatjana T. X. Schmitt¹, Simon L. Wadle¹, Jan J. Hirtz¹

¹Technische Universität Kaiserslautern, Physiology of Neuronal Networks, Erwin-Schrödinger Straße 13, 67663 Kaiserslautern, Germany

The auditory cortex (AC) modulates the upstream auditory pathway through descending corticofugal projections. Many of these projections arise from layer 5 of the AC and project to the inferior colliculus. These corticocollicular (CC) connections are involved in processing of complex sounds and auditory related learning. Partly due to their location in deep cortical layers, their population activity patterns within neuronal AC ensembles remain poorly understood. We used widefield and 2-photon calcium imaging in awake and anesthetized mice to record the activity of hundreds of layer 5 neurons. We observed that CC neurons are broader tuned than other AC layer 5 pyramidal neurons. Furthermore, although widefield imaging revealed a global tonotopic order, local best frequency distribution on single cell level indicated a less precise topography of frequency representation of CC neurons compared to neurons projecting to other targets. Interestingly, this observation was limited to the primary auditory cortex and the anterior auditory field and excluded the secondary auditory cortex. Activity cluster analysis in experiments using pure tone stimulations showed that CC neurons form large, reliable clusters. Furthermore, CC neurons in the primary auditory cortex and the anterior auditory field integrate information over larger distances than non-CC neurons. These findings are in line with our results regarding weak topographic order of CC neurons. Accordingly, the physical extend of activity clusters in the secondary auditory cortex did not differ between neuron types, or was even lower for CC neurons, depending on the sounds used for acoustic stimulation. Our findings demonstrate that AC activity topography is neuron type-dependent and suggest subfield-specific differences in the physiological role of CC neurons.

What factors influence the speed of task learning in a freely moving go/no-go paradigm?

Gökce Dogu¹, Valentin Winhart¹, Paula Gundi¹, Andrey Sobolev², Miguel Bengala¹, Dardo N. Ferreira^{2,3}, Michael Pecka^{1,2}

¹Graduate School of Systemic Neurosciences, Ludwig-Maximilians-Universität München, Munich, Germany

²Division of Neurobiology, Department Biology II, Ludwig-Maximilians-Universität München, Munich, Germany

³Department of General Psychology and Education, Ludwig-Maximilians-Universität München, Munich, Germany

Recent calls for more naturalistic experiments are challenging the experimental reductionism towards more behavioral variability during data acquisition. However, increasing behavior complexity during animal training (e.g. free exploration) may prolong learning periods and hinder assessment to what extent a subject's performance in a specific task is limited by its perceptual/neuronal sensitivity or by difficulties in the procedural learning of the task structure.

We have recently developed the Sensory Island Task (SIT), a flexible behavioral paradigm that combines closed-loop auditory feedback during self-motion and natural free exploratory behavior to study auditory processing. Animals are trained via positive reinforcement to search for a particular area in the arena ("target island"), which triggers a change in the presented stimulus. The animal reports detection of the target stimulus by remaining within the target island for a defined time ("sit-time"). The location of the target island is randomized across trials, making the stimulus feature under investigation the only informative cue for task completion. We have successfully trained animals (Mongolian gerbils) on sound features that are either based on spectral (frequency discrimination and identification) or temporal processing (sound localization) of monaural and binaural stimulus features, respectively. One advantage of SIT is its high flexibility in adapting various paradigm parameters (target island size, sit-time, etc.) to the specific behavioral repertoire and idiosyncrasies of each individual (e.g. locomotion speed). Nonetheless, we noticed that training periods consistently differed significantly between the frequency discrimination and sound localization task (few days vs multiple weeks, respectively), raising the question to what extent this difference in learning speed is caused by differences in underlying neuronal processing strategies (spectral vs temporal) or feature saliency. Specifically, spectral discrimination can be achieved monaurally and hence is independent of the animals' position in the arena, while sound localization is based on binaural cues, which dependent on the head-to-loudspeaker angle and hence changes constantly during free exploration, potentially resulting in diminished saliency. To answer this question, we trained gerbils on a monaural stimulus feature that is based on temporal processing: stimulus duration discrimination. We find that gerbils learned this task similarly fast as the spectral discrimination task, demonstrating that temporal processing per se is not a limiting factor for learning speed, but rather differences in saliency between monaural and binaural cue probabilities might shape training period durations. Interestingly, individual that were initially trained on a monaural task (and thus were already familiarized with the general task logic) exhibited considerably shortened learning periods for the subsequent training of the sound localization task. Thus, allowing for initial procedural learning of tasks in free-exploration paradigms may counteract saliency-based limitations in learning and facilitate generalization to more challenging stimulus features.

Poster Topic

T19: Chemical Senses: Olfaction, Taste, Others

- [T19-1A](#) Anatomical basis of olfactory processing in the brain of *Ixodes* ticks
Carola Städele
- [T19-2A](#) Anatomy of central gustatory circuits in the honey bee brain
Melissa Pitzalis, Virginie Larcher, Louise Bestea, Gabriela de Brito Sanchez, Martin Giurfa, Julie Carcaud, Jean-Christophe Sandoz
- [T19-3A](#) Axonal projections of main and accessory olfactory bulb principal neurons in mice
Moritz Nessler, Marc Spehr
- [T19-4A](#) Challenges and approaches for measuring whole-brain activity in non-model insects
Yvonne Hertenberger, Sercan Sayin, Einat Couzin-Fuchs, Armin Bahl
- [T19-5A](#) Characterization of innate odor driven exploratory behavior
Christian Daniel, Giovanni D`uva, Maria Ioannidou, Leticia Batista, Carlotta Martelli
- [T19-6A](#) Chemosensory processing of sickness related cues via the mouse accessory olfactory system
Friederike Donata Seifert, Marco Niestroj, Maciej Winiarski, Anna Bryska, Lydia Kopplin, Pavel Stopka, Alicja Puscian, Oliver Pabst, Minghong Ma, Marc Spehr
- [T19-7A](#) Circuit mechanisms controlling state-dependent food intake in *Drosophila*
Lara Lederle, Anna-Lena Eckes, Janina Brückner, Xinyu Liu, Rouven Lukas Ziegler, Jan Pielage
- [T19-8A](#) Early olfactory processing in antennal lobe neurons in the stick insect *Carausius morosus*
Andrea Gonsek, Volker Dürr, Martin Strube-Bloss
- [T19-9A](#) Effect of environment and internal state on *Drosophila* larval group behaviour
Akhila Mudunuri, Katrin Vogt
- [T19-10A](#) Electrophysiological and morphological characterization of periglomerular cells in the mouse accessory olfactory bulb
Hannah-Lena Tröger, Marc Spehr
- [T19-11A](#) Evolution of an olfactory subsystem and its link with the multiple emergences of eusociality in Hymenoptera
Simon Marty, Antoine Couto, Patrizia d`Ettorre, Stephen Montgomery, Jean-Christophe Sandoz

- [T19-1B](#) Evolution of chemosensory receptor repertoires
Sigrun I. Korsching, Daniel Kowatschew, Milan Dieris
- [T19-2B](#) Examination of membrane properties that control plasticity of kinetics and sensitivity in hawkmoth olfactory receptor neurons
Aditi Vijayan, Anna Schneider, Mauro Forlino, Katrin Schröder, Yajun Chang, Martin Garcia, Monika Stengl
- [T19-3B](#) Examination of spontaneous activity of pheromone-sensitive olfactory receptor neurons in the hawkmoth *Manduca sexta* and the role of Orco
Monika Stengl, Katrin Schroeder
- [T19-4B](#) Homeostasis of Mitochondrial Ca²⁺ Stores Is Critical for Signal Amplification in *Drosophila melanogaster* Olfactory Sensory Neurons
Eric Wiesel, Sabine Kaltofen, Bill S. Hansson, Dieter Wicher
- [T19-5B](#) Interindividual variation of synaptic partners: a study on the olfactory pathway of *Drosophila melanogaster*
Leticia Leandro Batista, Pascal Züfle, Carlotta Martelli
- [T19-6B](#) Investigation of dose-dependent modulatory mechanisms in mouse olfactory transduction
Victoria K. Switacz, Daniela R. Drose, Marc Spehr
- [T19-7B](#) Linear integration of taste and courtship song drive social interactions in *Drosophila* males
Adrián Palacios-Muñoz, Jan Clemens
- [T19-8B](#) Multisite imaging of neural activity using a genetically encoded calcium sensor in the honey bee *Apis mellifera*
Jean-Christophe Sandoz, Julie Carcaud, Marianne Otte, Bernd Grünewald, Albrecht Haase, Martin Beye
- [T19-9B](#) Obtaining numerical values of an olfactory system: first steps to characterize the olfactory pathway in the crustacean *Parhyale hawaiensis*
Katja Dorina Kümmerlen, Sophie Raspe, Steffen Harzsch
- [T19-10B](#) SNMP1 is critical for sensitive pheromone detection and pheromone-controlled behaviors in the desert locust *Schistocerca gregaria*
Joris Lehmann, Johanna Libnow, Maryam Khosravian, Hetan Chang, Markus Knaden, Bill S. Hansson, Jürgen Krieger, Jörg Fleischer
- [T19-11B](#) Social flexibility and olfactory processing in the desert locust
Inga Petelski, Yannick Guenzel, Sercan Sayin, Einat Couzin-Fuchs
- [T19-1C](#) Spike Frequency Modulation of Central Neurons in the Primary Olfactory Pathway of Insects

Jan Erik Radermacher, Debora Fusca, Svenja Corneliussen, Jonas M Klußmann, Peter Kloppenburg

- [T19-2C](#) State-dependent modulation of odor valence and social behavior via the main olfactory pathway
Annika Cichy, Adam Dewan, Jingji Zhang, Sarah Kaye, Tiffany Teng, Cassandra Blanchard, Paul Feinstein, Thomas Bozza
- [T19-3C](#) Synaptic mechanisms and their functions for stimulus adaptation in the Drosophila olfactory pathway
Sofia C. Brandão, Carlotta Martelli
- [T19-4C](#) The larval sensory system: From structure to function
Vincent Richter, Anna Rist, Anton Miroschnikow, Michael J. Pankratz, Albert Cardona, Michael Laumann, Andreas S. Thum
- [T19-5C](#) The mushroom body output encodes behavioral decision during sensory-motor transformation
Cansu Arican, Felix Johannes Schmitt, Wolfgang Rössler, Martin Fritz Strube-Bloss, Martin Paul Nawrot
- [T19-6C](#) The neuronal logic of how internal states control food choice
Daniel Münch, Dennis Goldschmidt, Carlos Ribeiro
- [T19-7C](#) The role of SNMP2 in the olfactory processes of moths
Sina Cassau, Jürgen Krieger
- [T19-8C](#) The search for olfactory receptors tuned to pheromones in the honey bee
Benjamin Andreu, Nicolas Montagné, Thomas Chertemps, Emmanuelle Jacquin-Joly, David Touboul, Amandine Huebert
- [T19-9C](#) The Sensilla-Specific Expression and Subcellular Localization of SNMP1 and SNMP2 Reveal Novel Insights into their Roles in the Antenna of the Desert Locust *Schistocerca gregaria*
Jürgen Krieger, Doreen Sander, Angelina Degen, Thomas Karcher, Stephanie Krüger, Michael Laue, Gerd Hause, Heinz Breer, Sina Cassau
- [T19-10C](#) Whole brain representation of odor and taste and their integration in the adult fly
Paul Bandow, Sophie Aimon, Ilona C. Grunwald Kadow
- [T19-11C](#) Binge eating suppresses flavor representations in the mouse olfactory cortex
Hung Lo

Anatomical basis of olfactory processing in the brain of *Ixodes* ticks

Carola Städele¹

¹University Medical Center Göttingen, Institute for Neuro- and Sensory Physiology, Humboldtallee 23, 37073 Göttingen, Germany

Ticks are economically significant ectoparasites and vectors for diseases such as Lyme borreliosis, tick-borne encephalitis, anaplasmosis, and rickettsia. About 900 tick species have been identified worldwide, but only about 20 species transmit human pathogens. However, these few species transmit a greater diversity of infectious agents than any other group of blood-feeding arthropods.

Ticks are true vampires. To survive, males and females must have at least one blood meal in each of their three life stages. Ticks are thought to possess sophisticated sensory abilities and a nervous system to locate and outwit their hosts efficiently. Various chemical and physical cues, including body odor, carbon dioxide (CO₂), heat, and vibration, have been proposed to be used by ticks. Still, our current understanding of tick sensory abilities is minimal.

Ticks are Arachnids, and together with mites, they constitute the subclass Acari. Ticks smell with their forelegs, which bear a specialized multi-sensory organ called Haller's organ. It is well-established that the Haller's organ is involved in tick olfaction. However, the neuronal basis for olfactory processing in ticks is mysterious, as well as the nervous system architecture. Despite a large body of behavioral evidence for olfaction in ticks, how ticks smell has remained a puzzle, and it is unclear how conserved mechanisms are across species.

To explore tick chemical sensing, we focus on two economically important sister tick species: the European castor bean tick (*Ixodes ricinus*) and the American black-legged tick (*Ixodes scapularis*). We are focusing on unfed adult animals (males and females). We are using retrograde neuronal tracing of foreleg projections, antibody staining, and 3D reconstruction techniques to decipher the anatomy of the *Ixodes* brain – the synganglion. Our data reveal that the Haller's organ is indeed essential for olfaction. Most foreleg neuronal projections (i.e., Haller's organ projections) terminate in olfactory glomeruli-like structures in a bilateral symmetrical area of the synganglion previously identified as olfactory lobes. A network of serotonergic innervation surrounds the olfactory glomeruli, resembling insect olfactory anatomy.

We found that the Haller's organ is likely the only sensory structure involved in olfaction in *Ixodes* ticks. Retrograde neuronal labeling of all other tick appendages and testable organs did not reveal sensory structures that terminate in the olfactory lobe or the olfactory glomeruli. Additionally, *Ixodes*' mouthparts seem to be predominantly gustatory.

We currently employ antibody staining to identify the olfactory glomeruli's anatomical fine structure and surrounding tissue. We anticipate that in-depth anatomical characterization will help identify potential mechanisms for olfactory coding in the *Ixodes* nervous system. So far, we have not identified significant differences between the neuronal anatomy of the two sister species, indicating that the *Ixodes* nervous system architecture is conserved across the genus.

Anatomy of central gustatory circuits in the honey bee brain

Melissa Pitzalis¹, Virginie Larcher¹, Louise Bestea², Gabriela de Brito Sanchez², Martin Giurfa², Julie Carcaud¹, Jean-Christophe Sandoz¹

¹University Paris-Saclay - CNRS, EGCE, 12 route 128, 91190 Gif-sur-Yvette, France

²Research Centre on Animal Cognition, Center for Integrative Biology, CNRS (UMR 5169), University of Toulouse, 118 route de Narbonne, F-31062 Toulouse cedex 09, France

Taste allows animals and humans to discriminate edible from non-edible items and is, therefore, crucial for survival. How taste information is encoded and modulated in the central nervous system is important both for the field of neurosciences and for managing food intake in species that play a major role in agriculture and food production. In the honey bee, an insect that is both a well-established model for neuroscience studies and a key species for crop pollination, the sense of taste has remained largely unexplored despite intensive studies on this insect's other sensory modalities (olfaction, vision).

Electrophysiological recordings showed that gustatory receptors, located on the antennae, the mouthparts and the tarsi, respond with varying sensitivity to sugars, salts, and possibly amino acids, proteins and water. However, the sequencing and annotation of the honey bee genome revealed a surprising scarcity of gustatory receptor genes (GRs) compared to other insect species, which possess several dozens of GRs. In the honey bee, only 11 functional GRs and 3 pseudogenes have been identified so far. How taste sensations arise from such a reduced number of gustatory input channels remains unknown and calls for a thorough analysis of central taste processing in the bee brain.

Here we report neuroanatomical reconstructions of central gustatory circuits of the honey bee. We described the output neurons of the subesophageal zone (SEZ), the primary gustatory center, and confirmed the Subesophageal-Calycal Tract (SCT) as the main output of this structure. We also performed retrograde staining of the SCT coupled to anterograde staining of the antennae or proboscis, which allowed us to draw up a map of sensory inputs to the SEZ. We show that SCT dendrites overlap with sensory input from the proboscis but not the antennae in the SEZ. We are currently developing a preparation to perform electrophysiological recordings of the SEZ during gustatory stimulations.

Axonal projections of main and accessory olfactory bulb principal neurons in mice

Moritz Nessler¹, Marc Spehr¹

¹Department of Chemosensation, Institute for Biology II, RWTH Aachen University, Aachen, Germany

Chemosensory stimuli are detected via specialized sensory organs in the rodent nasal cavity. Here, peripheral sensory neurons transduce chemical stimuli into neuronal activity and relay this information to the olfactory bulb. Although many chemosensory signals are detected by sensory neurons of the main olfactory epithelium, semiochemicals and other social signals are primarily detected by the vomeronasal system. Centrally, main and vomeronasal information is processed separately in the main and accessory olfactory bulb, respectively. Each circuit's principal projection neurons, mitral/tufted cells, extend axonal projections towards downstream target regions. Despite anatomical investigations of the main or accessory olfactory circuitry, comparative analysis of individual projection paths using modern tracing techniques and largely intact brain samples is lacking.

We unveiled the main and accessory olfactory pathways using animals that express Cre-recombinase under the t-box protein 21 promoter and stereotactic injections of recombinant adeno-associated viruses (rAAV). Microinjections of these Cre-dependent rAAVs restricted expression to either main or accessory olfactory bulb principal neurons. Whole-brain slice preparations, cleared tissue samples, and confocal microscopy enabled the three-dimensional assessment of olfactory bulb axonal projections and the identification of olfactory target regions.

Altogether, we describe selective axonal projections of main or accessory olfactory bulb principal neurons, enabling the comprehensive characterization of both unique and shared projection targets of these two central olfactory pathways. We, therefore, provide the foundation for future investigations into the integrative processing of olfactory information in these target regions.

Challenges and approaches for measuring whole-brain activity in non-model insects

Yvonne Hertenberger¹, Sercan Sayin², Einat Couzin-Fuchs^{1,2,3}, Armin Bahl²

¹University of Konstanz, Neurobiology, Universitätsstraße 10, 78464 Konstanz, Germany

²Centre for the Advanced Study of Collective Behaviour, University of Konstanz, Konstanz 78464, Germany

³Department of Collective Behaviour, Max Planck Institute of Animal Behavior, 78464 Konstanz, Germany

The insect world constitutes of an enormous variety of behavioral repertoires across innumerable species. This comprehensive dictionary offers an excellent opportunity to understand how nervous systems generate algorithms for solving reoccurring questions. Despite these opportunities in the field of evolution and neurobiology, exploring underlying neuronal correlates is challenging due to the lack of specific tools for most of these species. Existing tools have drawbacks. Importing genetically encoded calcium markers is arduous and costly, even with the availability of the CRISPR-Cas9 system. Calcium and voltage dyes can be lacking in photostability. Electrophysiology requires extensive training and can be limited in spatial information. Based on rapid gene expression, immediate early genes have been used, especially in mammalian systems, to characterize recent behavioral history. Such tools can offer a window to unbiased, hypothesis-free, exploratory whole-brain analyses without focusing on a particular brain region. Here we are leveraging our expertise in peripheral sensory modalities in insect organisms. Using controlled olfactory stimulus delivery, we explored odor-driven responses in the desert locust, *Schistocerca gregaria*, the American cockroach, *Periplaneta americana*, the honeybee, *Apis mellifera*, and fruit fly *Drosophila melanogaster*. We utilized straightforward processing pipelines to create species-specific template brains onto which activity maps could be registered. We hope this package will expand the number of species investigated in the insect neurobiology.

Characterization of innate odor driven exploratory behavior

Christian Daniel¹, Giovanni D`uva¹, Maria Ioannidou¹, Leticia Batista¹, Carlotta Martelli¹

¹Johannes Gutenberg University Mainz , Institute of Developmental Biology and Neurobiology (iDN), Hans-Dieter-Hüsch-Weg 15, 55128 Mainz, Germany

During exploration fruit flies must successfully navigate through a highly variable and ever-changing environment to avoid predators, locate suitable mates or viable food sources. To find the most favorable path, sensory stimuli are used to predict possible benefits or harm, before actions are executed. In the context of olfaction, many odors are innately associated with a value, either positive (attractive), or negative (repulsive) that drives respectively approach and avoidance behaviors. These values are constantly re-evaluated and updated throughout the lifespan of a fruit fly in the context of experience-dependent inner- and outer-state information. Cues with innate valence raise expectations of feedback, mostly in the form of reward or punishment, but also possibly in the form of a gain of information. When these predictions are not fulfilled the representation of an odor-associated value should change. Which neural computations mediate this flexibility remains to be understood. We aimed at characterizing the behavior of flies during odor source exploration to identify these key computations.

With the help of a novel free walking assay, we show that exploratory behavior towards innate attractive odorants is indeed flexible over time. We analyzed trajectories of naïve fruit flies that are exposed to a continuous and stable odor cue without receiving reward nor punishment over 15 minutes. We found that after inspecting an innately attractive odor source (methyl acetate, 2-butanone), flies lose interest within the timespan of several minutes. They then switch from approach behavior to neutral exploratory behavior. Flies therefore are able to update and re-evaluate valence that is associated to odor-cues, when expectations are not fulfilled. In contrast to appetitive odors, innately aversive odor cues (benzaldehyde) are persistently avoided over time, suggesting valence specific flexibility in odor driven behavior.

Looking at the behavior of individual flies, we identified two different behavioral phenotypes: some flies repeatedly visit the odor source but also explore its surroundings, while a second group of flies persistently stay at the odor source for several minutes before switching behavior. We show how these phenotypes depend on the arenas' dimensions and on group interactions.

Finally, we investigate whether flexible behavior towards an unrewarding appetitive cue is based on an update of innate value associated to the odor, or rather requires the learning of positional information within the behavioral arena. For this we introduce two odor cues of the same type at different locations, either simultaneously or temporally separated, to understand whether flies learn to associate a spatial location with the lack of reward or rather re-evaluate the odor cue itself.

Our results demonstrate the importance of innate value for exploration and re-evaluation of olfactory cues and the existence of different strategies in genetically identical individuals, offering the opportunity for investigating how these computations are implemented in the brain.

Chemosensory processing of sickness related cues via the mouse accessory olfactory system

Friederike Donata Seifert¹, Marco Niestroj¹, Maciej Winiarski², Anna Bryska², Lydia Kopplin³, Pavel Stopka⁴, Alicja Puscian², Oliver Pabst³, Minghong Ma⁵, Marc Spehr¹

¹RWTH Aachen University, Department of Chemosensation, Worringerweg 3, 52074 Aachen, Germany

²Laboratory of Emotions' Neurobiology, Center of Excellence for Neural Plasticity and Brain Disorders BRAINCITY, Nencki Institute of Experimental Biology, 3 Pasteur Street, 02-093 Warszawa Warsaw, Poland

³Institute of Molecular Medicine, University Hospital, RWTH Aachen, Pauwelsstraße 30, 52074 Aachen, Germany

⁴Biotechnology and Biomedicine Center of the Academy of Sciences and Charles University in Vestec (BIOCEV), Prumyslová 595, 252 42 Vestec, Czech Republic

⁵Department of Neuroscience, University of Pennsylvania Perelman School of Medicine, 109 Johnson Pavilion, 3610 Hamilton Walk, Philadelphia, PA 19104, USA

Chemosensory evaluation of a conspecific's health status is essential for rodent social behavior. We hypothesize that mice detect health status during social interactions via the accessory olfactory system. Here, we address this issue using an integrated approach that combines chemical analysis of rodent scent marks, physiological analysis of vomeronasal sensory neuron activity in response to chemosignals from healthy versus sick individuals, and behavioral responses to such stimuli. Using RAG-KO mice which develop colitis upon T-cell injection, we collect bodily secretions (urine and bedding) at various stages of disease progression and test for activation of the accessory olfactory system. Our results reveal i) the molecular identity of candidate sickness-related cues, and ii) health state-dependent activation patterns in sensory neurons within the vomeronasal organ. Employing genetically labeled sensory neurons that express a defined vomeronasal receptor, we investigate a potential role of this receptor in disease-specific cue detection. Finally, we report behavioral data that support the notion of sickness-related cue processing via the accessory olfactory system.

Circuit mechanisms controlling state-dependent food intake in *Drosophila*

Lara Lederle¹, Anna-Lena Eckes¹, Janina Brückner¹, Xinyu Liu², Rouven Lukas Ziegler¹,
Jan Pielage¹

¹Technische Universität Kaiserslautern, Department of Zoology and Neurobiology, Erwin-Schrödinger-Straße 13, 67663 Kaiserslautern, Germany

²Friedrich Miescher Institute for Biomedical Research, Basel, 4058, Switzerland

Precise regulation of food uptake is an essential feature for the survival for all animals. A variety of factors contribute to appropriate feeding decisions. These factors include precise integration of sensory stimuli, the internal nutritional state of the animal as well as prior experiences. To date, surprisingly little is known regarding the neuronal circuits that regulate and control state-dependent feeding behavior. The gustatory circuit of the fruit fly *Drosophila melanogaster* represents an excellent model to explore these circuits due to the unique combination of genetic tools, anatomical knowledge, and a simple response pattern of feeding behaviour.

Here, we describe a novel class of gustatory interneurons (GINvm) that serve as a signalling hub to integrate both sensory and satiety signals to modulate food intake based on the internal state of the animal. We identified a cluster of neurons with an almost identical morphology whose cell bodies are in the ventral-medial suboesophageal zone (SEZ). Morphological analyses demonstrate a unique projection pattern throughout the whole brain with neuronal arborizations branching into the dorsal-medial SEZ and axonal projections reaching the pars intercerebralis (PI) region of the brain. Using genetic targeting and artificial silencing in combination with proboscis extension response assays we show that GINvm-neurons are required for fine-tuning sweet-sensitivity in starved flies at physiological sucrose concentrations through interplay with insulin producing cells (IPCs). We propose that GINvm-neurons represent a gain-control and feed-forward module of information processing within the gustatory system necessary for the integration of taste and hunger signals.

Early olfactory processing in antennal lobe neurons in the stick insect *Carausius morosus*

Andrea Gonsek¹, Volker Dürr¹, Martin Strube-Bloss¹

¹Bielefeld University, Biological Cybernetics

For reliable spatial orientation in darkness, where the use of vision is limited, many insects rely on other sensory modalities such as touch, gustation, or olfaction. Insect antennae, being dedicated multi-sensory organs, play a key role in the sensation of these modalities. The stick insect *Carausius morosus* carries two long antennae and several studies have addressed their use in active tactile sensing and the sensory control of locomotion. During walking, the antennae are constantly moving in a rhythmic manner, and show an increased sampling frequency upon antennal contact events that guide targeted leg movements. In addition to facilitate tactile information, antennal sampling might also serve to gain olfactory information, which has been studied very little in stick insects so far. However, chemosensory, tactile and proprioceptive information need to be integrated in order to adjust behavioural responses appropriately, including changes in antennal movement. To expand our understanding of multimodal integration and its effect on antennal movement, the present study focuses on the neural processing of olfactory information. We conducted multi-unit recordings of antennal lobe (AL) neurons and characterized their response profiles to a set of ecologically relevant odours, including hexanal, a main component of the smell of freshly cut leaves. Indeed, hexanal-induced activity in the AL was increased, underlining its behavioural relevance to herbivorous stick insects. Unexpectedly, a subpopulation of AL neurons responded reliably not only to odour but also to the sound of our stimulation device. This suggests hitherto unknown mechanosensory sensitivity to airborne vibrations in stick insects in general, and in the AL in particular. Since we visualized the electrodes' recording positions we are certain that only neural activity within the AL was recorded. Taken together, our data suggest that, besides the separation of biologically relevant odours, the AL in stick insects might already integrate mechanosensory and olfactory information at an early processing level. We will further investigate this, using our established methods.

Effect of environment and internal state on *Drosophila* larval group behaviour

Akhila Mudunuri^{1,2}, Katrin Vogt^{1,2}

¹Department of Neurobiology, University of Konstanz, Universitätsstraße 10, 78464 Konstanz

²Centre for the Advanced Study of Collective Behavior, University of Konstanz, Universitätsstraße 10, 78464 Konstanz

Drosophila larvae benefit from group behaviour as they can burrow together to find better quality food resources. However, this exposes them to cannibalism and makes them prone to disease. This motivates us to study how *Drosophila* larvae interact in a group and understand how it is modulated by the environment. To explore this, we tracked second instar *Drosophila* larvae in the dark on agarose medium for 15 minutes in groups of 15 as well as single larva. From the videos, we analysed various behaviour parameters such as speed, turn rate and average distance maintained with their neighbours. To understand how larval group behaviour is affected by a change in environment, we tracked larvae in the light. As larvae are prone to cannibalism in limited resource condition, we wanted to also explore how resource availability as well as internal state such as starvation affects group behaviour. We observe that single larvae are much more affected by a change in environment than when they are in a group. Larvae in a group always want to maintain a certain distance with their neighbours irrespective of the environment. This motivates us to further look into the neural basis behind this behaviour.

Electrophysiological and morphological characterization of periglomerular cells in the mouse accessory olfactory bulb

Hannah-Lena Tröger¹, Marc Spehr¹

¹Department of Chemosensation, Institute for Biology II, RWTH Aachen University, Aachen, Germany

The mouse accessory olfactory system plays a key role in the detection of chemosignals during conspecific social interactions. Sensory information detected by the system's peripheral structure, the vomeronasal organ, is sent via the vomeronasal nerve to the accessory olfactory bulb (AOB). At this first central stage of information processing, AOB mitral cells (AMCs) receive excitatory synaptic input from vomeronasal sensory neurons in multiple glomeruli. Local interneurons surrounding the glomeruli are collectively designated as periglomerular cells (PGCs). However, it is unknown whether PGCs form a homo- or heterogeneous neural population. Furthermore, the physiological function(s) of this AOB neuron population remains elusive. Here, we perform whole-cell patch-clamp recordings from visually identified PGCs in acute slices of the mouse AOB to investigate their biophysical properties. In addition, diffusion loading with biocytin is used to label PGCs for *post-hoc* morphological analysis, allowing for correlation of structural and functional characteristics. In order to determine cell type-specific features, passive and active membrane properties are analyzed. PGCs are characterized by high excitability. With fast action potential kinetics, PGCs exhibit discharge at relatively high frequencies. Voltage-dependent potassium, sodium, and calcium currents display distinct activation and inactivation properties. Our results thus reveal both the biophysical properties and morphological features of an elusive AOB neuron population and provide first insight into physiological PGC characteristics.

Evolution of an olfactory subsystem and its link with the multiple emergences of eusociality in Hymenoptera

Simon Marty¹, Antoine Couto², Patrizia d'Etto³, Stephen Montgomery², Jean-Christophe Sandoz¹

¹ Evolution Genome Behavior and Ecology, CNRS, IRD, Université Paris-Saclay, France

² School of Biological Science, University of Bristol, UK

³ Laboratory of Experimental and Comparative Ethology, University of Sorbonne Paris, France

Eusociality, one of the most remarkable form of animal society, is primary characterized by a reproductive division of labor where altruistic individuals (workers) forego their own reproduction to help the reproductive individuals (queens) and their progeny. The benefit of altruism is lost when directed toward non-relatives and so the ability to discriminate kin from non-kin appears pivotal for the emergence of the eusociality. Hymenoptera gather the highest number of eusocial species with multiple emergences unmatched in other taxa, suggesting that certain factors have facilitated evolution toward eusociality. Ants and hornets, both eusocial, are thought to possess an olfactory subsystem dedicated to the detection of nestmate odors, mostly cuticular hydrocarbons (CHC). CHC are detected within basiconic sensilla on the antennae. These sensilla house olfactory sensory neurons whose axons project to a distinct cluster of glomeruli in the antennal lobe (known as the T6 in ants). This region is also characterized in both species by a lack of serotonergic projections, contrary to the rest of the antennal lobe. Since ants and hornets have independently acquired eusociality and are phylogenetically distant within Hymenoptera, we investigated the evolutionary origins of this subsystem and its possible link with the multiple emergences of eusociality. To this end, we carried out a comparative neuroanatomical and immunohistochemical study of the antennal lobe on a broad sampling of Hymenoptera. Our data suggest that the subsystem is ancient and present in social as well as solitary Hymenoptera, but that the loss of serotonergic projections is not ubiquitous and follows a complex evolutionary pattern. We are currently describing these patterns in details in ants and wasps.

Evolution of chemosensory receptor repertoires

Sigrun I. Korsching¹, Daniel Kowatschew¹, Milan Dieris¹

¹Institut für Genetik, Department für Biologie, Zülpicher Str. 47a, 50674 Köln, Germany

The sense of smell is carried in vertebrates by four major and several minor olfactory receptor families, with the largest family, the ORs proper, being present already in cephalochordates. The origin of the other families has been assigned to either the common ancestor of vertebrates (trace amine-associated receptors, TAARs and vomeronasal type 1 receptors, V1Rs) or to the common ancestor of jawed fish (TAARs and V2Rs). We have taken advantage of the recent availability of high quality genomic databases of early-derived chordates to re-assess the origin of these olfactory receptor families. We find no evidence for any of these receptors to be present outside of the vertebrate subphylum, confirming previous assessments. We clarify the TAAR receptors of lamprey (jawless vertebrate) as a TAAR-like sister clade to the TAAR family of jawed vertebrates. This sister clade is also present in jawed vertebrates but there it has not undergone gene expansion and is not expressed in olfactory sensory neurons. We show the lamprey V1R family to consist of six genes, with one of them a direct ortholog of a gene conserved in bony fish and another an ortholog of a gene pair conserved between sharks and bony fish. We report the presence of 1-2 V2R receptors in lampreys, shifting the origin of the V2R family back to the common ancestor of vertebrates. Moreover we show that *adorb* (synonym A2C), an olfactory receptor for nucleotides, is present already in cephalochordates (lancelets), hemichordates (acorn worms) and echinoderms (sea stars and sea urchins), suggesting its presence in the common ancestor of deuterostomes. Neither lamprey V2Rs nor lamprey *adorb* are expressed in olfactory sensory neurons, in contrast to lamprey V1Rs and TAAR-like genes. The work reported here provides a molecular basis to examine the origins of olfactory receptor function.

Examination of membrane properties that control plasticity of kinetics and sensitivity in hawkmoth olfactory receptor neurons

Aditi Vijayan¹, Anna Schneider¹, Mauro Forlino², Katrin Schröder¹, Yajun Chang¹, Martin Garcia², Monika Stengl¹

¹University of Kassel, Animal Physiology, Heinrich-Plett-Straße 40, 34132 Kassel, Germany

²University of Kassel, Theoretical Physics, Heinrich-Plett-Straße 40, 34132 Kassel, Germany

Hawkmoth olfactory receptor neurons (ORNs) innervate long pheromone-sensitive trichoid sensilla on the male moth antennae. ORNs respond to pheromone concentrations over several log units, making the process of pheromone transduction a highly sensitive affair with a very large dynamic range. Furthermore, ORNs can track intermittent pheromone stimulation up to about 10 Hz, which allows the males to locate the calling females. Unresolved mechanisms of sensitization and adaptation further extend the ORNs' response range. Therefore, sensitivity and kinetics of ORNs' pheromone responses are very plastic. They appear to involve different mechanisms and ion channels, dependent on time of day, and on strength, intermittency, and duration of previously experienced pheromone exposure. Pheromone responses are most sensitive and have faster kinetics during the night, when nocturnal hawkmoths are active, as compared to daytime when they are resting. Daily changes in ORN's sensitivity and kinetics correlate with daily rhythms in antennal cAMP levels. Accordingly, cAMP analogs infused into trichoid sensilla sensitized, while cGMP infusions adapted pheromone responses in *in vivo* tip-recordings. Also, different labs reported that low pheromone concentrations activated phospholipase C in moth antennae, while strong and long pheromone stimulation elevated cGMP levels. Based on published biochemical evidence and our own electrophysiological data collected *in vivo* as well as *in vitro*, we developed a new hypothesis. We suggest that the plastic control of sensitivity and kinetics of hawkmoth ORNs is mediated via pull-push mechanisms that are orchestrated via interlinked circadian and ultradian rhythms in membrane potential, in Ca²⁺, and cyclic nucleotide levels.

To challenge our hypothesis, we performed tip-recordings of pheromone-sensitive trichoid sensilla of *M. sexta* *in vivo* combined with pharmacology to examine general membrane properties of ORN's. First, we developed an assay employing current injection protocols at increasing or decreasing frequencies (ZAPs) as approximation for intermittent pheromone stimulation at different frequencies. With *in vivo* ZAPs, combined with application of second messengers or ion channel antagonists, we will examine whether membrane properties of hawkmoth ORNs are tuned via second messenger-dependent pacemaker channels that allow for adaptive membrane resonance. Membrane resonance describes a frequency-specific increase in a neuron's impedance, which makes neurons more sensitive to inputs that occur at the same specific frequency range. Based on our physiological data, we are going to build a computational model of the plasma membrane's clockwork to gain insights about potentially required resonance properties and interactions of second messenger- and voltage-dependent ion channels. Tuning of those properties could enable hawkmoths to predict and make use of any regularity in their chemical surroundings, adjusting sensitivity and kinetics to their respective needs. Understanding self-organizing membrane rhythms and underlying mechanisms would shed light on plasticity of gain control and kinetic properties that might reveal general mechanisms governing stimulus transduction cascades.

[Supported by DFG grants STE531/20-1,2 to MS and GRK 2749-1]

Examination of spontaneous activity of pheromone-sensitive olfactory receptor neurons in the hawkmoth *Manduca sexta* and the role of Orco

Monika Stengl¹, Katrin Schroeder¹

¹University of Kassel, Biology, Animal Physiology/Neuroethology, Karl von Frisch Str. 40, 35132 Kassel, Germany

Nocturnal *Manduca sexta* hawkmoths feed at dusk and dawn and mate during the night. Males' and females' ultradian feeding rhythms are entrained to their food plants' nectar production rhythms, while their nightly mating rhythms are synchronized via circadian release of the female's sex pheromones. Pheromone pulses released by female hawkmoths at night are patterned into intermittent filament stimuli by turbulent air. The frequency of these pheromone pulses entails information about the upwind distance of the calling female. Thus, behaviorally relevant pheromone and odor stimuli express ultradian as well as circadian rhythmicity in the hawkmoths' environment. It is known that hawkmoth olfactory receptor neurons (ORNs) generate spontaneous action potentials at low, ultradian frequencies that are not randomly distributed. Thus, ORNs generate endogenous ultradian membrane potential oscillations with unknown mechanisms and unknown purpose. Also, it is not known which pacemaker channel types are responsible for these ultradian endogenous rhythms. Furthermore, it is not known whether spontaneous action potential activity changes during the sleep-wake cycles. It is possible that these changes in spontaneous action potential activity are modulated via a circadian clock to serve circadian changes in ORNs' pheromone sensitivity and temporal resolution.

We conducted long-term tip-recordings of single trichoid sensilla to examine the spontaneous action potential activity over the course of several days in search for daily rhythmicity. Indeed, ultradian spontaneous action potential rhythms expressed a daily modulation in the circadian time range in different animals (n=5) with higher activity during the night, the activity phase of nocturnal hawkmoths. Furthermore, average burst frequency and burst duration, as well as average numbers of action potentials per burst expressed a daily modulation across hawkmoths. It was shown before that the olfactory receptor coreceptor (Orco) is involved in the generation of spontaneous activity in absence of pheromone stimulation. Furthermore, in the fruit fly *Drosophila melanogaster* Orco-dependent phosphorylation via protein kinase C (PKC) increases open time probability of Orco and renders Orco sensitive to cyclic nucleotides. Therefore, we performed tip-recordings combined with pharmacology at two different Zeitgeber times (ZTs), at ZT 9-11, when hawkmoths rest, and at ZT 1-3, the end of the hawkmoths' activity phase at dawn. We examined whether activation of PKC via phorbol esters and application of cyclic nucleotides with or without PKC activation affects spontaneous activity daytime-dependently in hawkmoth ORNs. Indeed, we found ZT-dependent second messenger modulation of spontaneous activity that was, however, different from the published findings of Orco-modulation in *Drosophila*. Therefore, our future experiments will examine whether the ZT-dependent second messenger modulation of spontaneous activity depends on Orco or other pacemaker channels in hawkmoth ORNs.[Supported by DFG grants STE531/20-1,2 to MS and RTG 2749-1 "multiscale clocks"]

Homeostasis of Mitochondrial Ca^{2+} Stores Is Critical for Signal Amplification in *Drosophila melanogaster* Olfactory Sensory Neurons

Eric Wiesel¹, Sabine Kaltofen¹, Bill S. Hansson¹, Dieter Wicher¹

¹Max Planck Institute for Chemical Ecology, Department of Evolutionary Neuroethology, Hans-Knöll-Straße 8, 07745 Jena, Germany

Insects detect volatile chemosignals with olfactory sensory neurons (OSNs) that express olfactory receptors. Among them, the most sensitive receptors are the odorant receptors (ORs), which form cation channels passing Ca^{2+} . OSNs expressing different groups of ORs show varying optimal odor concentration ranges according to environmental needs. Certain types of OSNs, usually attuned to high odor concentrations, allow for the detection of even low signals through the process of sensitization. By increasing the sensitivity of OSNs upon repetitive subthreshold odor stimulation, *Drosophila melanogaster* can detect even faint and turbulent odor traces during flight. While the influx of extracellular Ca^{2+} has been previously shown to be a cue for sensitization, our study investigates the importance of intracellular Ca^{2+} management. Using an open antenna preparation that allows observation and pharmacological manipulation of OSNs, we performed Ca^{2+} imaging to determine the role of Ca^{2+} storage in mitochondria. By disturbing the mitochondrial resting potential and induction of the mitochondrial permeability transition pore (mPTP), we show that effective storage of Ca^{2+} in the mitochondria is vital for sensitization to occur, and release of Ca^{2+} from the mitochondria to the cytoplasm promptly abolishes sensitization. Our study shows the importance of cellular Ca^{2+} management for sensitization in an effort to better understand the underlying mechanics of OSN modulation.

Supported by the DFG (SPP2205)

Interindividual variation of synaptic partners: a study on the olfactory pathway of *Drosophila melanogaster*

Leticia Leandro Batista¹, Pascal Züfle¹, Carlotta Martelli¹

¹Johannes Gutenberg Universität Mainz, Institute of Developmental Biology and Neurobiology (iDN), Hans-Dieter-Hüsch Weg 15, 55128 Mainz, Germany

The fruit fly *Drosophila melanogaster* shows highly individualized perception of odors, with persistent idiosyncratic preferences when naïvely choosing between olfactory stimuli. Innate behaviors like this one show individual variation even among genetically identical animals and likely arises from both stochastic developmental events and post-developmental modulation. Innate olfactory behavior relies on projection neurons (PNs) to forward odor information from peripheral receptor neurons to the lateral horn neurons (LHNs). Recent studies indicate a putative variability of PN-LHN partners, as well as a lack of correlation between PN-LHN synaptic strength and physiological response for both available *D. melanogaster* connectomes. As these connections' variability were still unknown, in this work we quantify the variability in wiring of five LHNs cell types to its PN presynaptic partner across animals and hemispheres. For that, BacTrace and trans-Tango were used for retrograde and anterograde trans-synaptic labeling, and partners could be quantified and identified. Therefore we provide the first quantitative description of inter-individual differences in adult olfactory pathway wiring.

Investigation of dose-dependent modulatory mechanisms in mouse olfactory transduction

Victoria K. Switacz¹, Daniela R. Droese¹, Marc Spehr¹

¹RWTH Aachen University, Department of Chemosensation, Institute for Biology II, Worringer Weg 3, 52074 Aachen, Germany

Adaptation to prolonged or repetitive stimuli is a critical modulatory mechanism of sensory systems, leading to temporarily decreased sensory sensitivity. In olfactory sensory neurons (OSNs), activation of odorant receptors (ORs) and subsequent G protein-coupled signaling leads to negative feedback via Ca²⁺-calmodulin and, thus, sensory adaptation. However, many ORs show high sensitivity and are activated already at (sub)micromolar concentrations (Firestein *et al.*, 1993; Grosmaitre *et al.*, 2006). Previous studies observed a dose-dependent modulation of sensory sensitivity in isolated mudpuppy OSNs (Zhang & Delay, 2006). Similarly, we performed pilot experiments in mouse OSNs using IBMX + forskolin as a “broadband” stimulant and Ca²⁺-imaging, which revealed a summation and even potentiation of responses in a dose-dependent manner. With increasing stimulus concentrations, the number of summing cells decreased while the number of adapting cells increased. However, the exact mechanism behind this modulation is not yet explored. Using whole-cell patch clamp recordings of OSNs in acute main olfactory epithelium (MOE) tissue slices, we aim to (i) investigate which signaling cascade steps / components are modulated during adaptation versus summation processes, (ii) whether dose-dependency is receptor-(in)dependent and (iii) whether the ability to modulate responses is a stable or transient OSN feature. Together, we want to gain insight into how OSNs adjust their odor sensitivity and therefore can cover a very broad range of stimulus concentrations.

Linear integration of taste and courtship song drive social interactions in *Drosophila* males

Adrián Palacios-Muñoz¹, Jan Clemens¹

¹ENI, Neural Computation and Behavior group, Grisebachstr. 5, 37077 Göttingen, Germany

During social interactions, animals exchange information through multiple sensory modalities. For male fruit flies, this information guides the decision to engage in courtship or to compete for resources in the surrounding area. Two sensory modalities are the most relevant: the chemical cues from the target, i.e. taste and smell, and the acoustic cues from other nearby males engaging in courtship.

The males' drive and type of social interaction largely depends on the recognition of the target's gender. This recognition is mediated by taste receptors on the foreleg tarsi, which are activated when tapping the body of the target. Chemical cues from a female increase the males' drive to interact and lead to courtship. By contrast, male chemical cues suppress the drive to interact and are more likely to lead to aggression.

Interestingly, playback of courtship song, which mimics the event of nearby males singing to other females, can evoke courtship between males, overriding the suppressive cues from the taste of other males. This implies that these acoustic and chemical cues are integrated to influence the decisions of males. However, we do not know how males integrate song and taste, or if these cues contribute to unique aspects of the males' behavior.

To study the integration of song and chemical cues, we performed genetic, physical and optogenetic manipulations of gustatory, olfactory and auditory inputs to the male fly. Using a generalized linear model that predicts the amount of interaction with a male or female target, we characterized the computation and the weights underlying cue integration. Our results suggest that males linearly integrate taste and song cues. Male taste has a negative weight, while female taste has a positive weight. However, the magnitude of the weights for chemical cues and for song is independent of target sex. Furthermore, social experience and genetic background impact the male's baseline drive to socially interact without changing how they integrate taste and song cues.

Lastly, we find that playback of song drives aggression towards both male and female targets, suggesting that song influences the choice between aggression or courtship independent of target sex. We are currently testing whether this aggression is the result of song-induced arousal or a behavioral response that is specific to song.

In summary, we provide the first quantitative assessment of how males integrate chemical and acoustic social cues to drive social interactions. Our results pave the way for studying how chemical and acoustic cues are integrated in the brain.

Multisite imaging of neural activity using a genetically encoded calcium sensor in the honey bee *Apis mellifera*

Jean-Christophe Sandoz¹, Julie Carcaud¹, Marianne Otte², Bernd Grünewald³, Albrecht Haase⁴, Martin Beye²

¹Evolution, Genomes, Behavior and Ecology, Université Paris-Saclay, CNRS, IRD, Gif-sur-Yvette, France

²Evolutionary Genetics, Heinrich Heine University Düsseldorf, Düsseldorf, Germany

³Institut für Bienenkunde, Polytechnische Gesellschaft, FB Biowissenschaften, Goethe-University, Frankfurt am Main, Germany

⁴Center for Mind/Brain Sciences, University of Trento, Rovereto, Italy

Sociality is classified as one of the major transitions in evolution, and the most advanced level of sociality is found in eusocial insects such as the honey bees. This sophisticated social behavior seems to be associated with higher cognitive abilities in these insects, however the study of their neural bases has been limited by the lack of tools that allow measuring neuronal activity simultaneously in different brain regions of the honey bee brain. Here, we developed the first pan-neuronal genetic driver in a Hymenopteran model organism, the honey bee, and expressed the calcium indicator GCaMP6f under the control of the honey bee synapsin promoter. We show that GCaMP6f is widely expressed in the honey bee brain, allowing to record neural activity from multiple brain regions simultaneously, including from poorly investigated brain regions such as the mushroom body calyces or the lateral horn. Our recordings show that while odorant quality (chemical structure) and quantity are faithfully encoded in the honey bee antennal lobe, odor coding in the lateral horn departs from this simple physico-chemical coding, in line with the role of this structure in coding the biological value of odorants. These brain recordings represent the first use of a neurogenetic tool for recording neural activity in a eusocial insect.

Obtaining numerical values of an olfactory system: first steps to characterize the olfactory pathway in the crustacean *Parhyale hawaiiensis*

Katja Dorina Kümmerlen¹, Sophie Raspe¹, Steffen Harzsch¹

¹University of Greifswald, Zoological Institut and Museum, Soldmannstraße 23, 17489 Greifswald, Germany

The specialized sensilla on the first antennae of malacostracan crustaceans that receive olfactory cues are called aesthetascs. These aesthetascs are associated with olfactory sensory neurons (OSNs) expressing ionotropic receptor molecules. The primary olfactory centers (olfactory lobe) in the brain of crustaceans received input from the afferents of the olfactory sensory neurons. The olfactory lobes are subdivided into dense synaptic neuropils, the glomeruli, surrounding a fibrous core. Within these glomeruli, the afferents, local interneurons and projection neurons interact at a synaptic level. From the olfactory lobe, the projection neuron tract extends to higher order neuropils such as the lateral protocerebrum (Harzsch & Krieger 2018, *Progress in Neurobio*, 161, pp.23-60; Schachtner et al. 2005, *Arthropod Struct. Dev.* 34, 257–299). As shown in previous experiments, the olfactory lobe of *Parhyale hawaiiensis* displays a diverse neurochemistry. However, our knowledge on the numbers of the neuronal elements involved in the olfactory pathway is insufficient. For the larger decapod crustaceans such as *Panulirus argus* (Schmidt & Ache, 1996, *J. Comp. Physiol.* 178, 605–628.; Steullet et al., 2000, *J. Comp. Neurol.* 418, 270–280) and *Procambarus clarkii* (Beltz et al., 2003, *J. Comp. Neurol.* 455, 260–269; Blaustein et al., 1988, *J. Crustac. Biol.* 493– 519; Mellon and Alones, 1993 *Microsc. Res. Tech.* 24, 231–259), the exact numbers of aesthetascs, OSNs, glomeruli and projection neurons are known, but not for smaller crustaceans with a presumably simpler olfactory system in the size range of that of insects. Using multiple techniques including electron microscopy, florescence microscopy, 3D reconstruction, backfilling and focal injection as well as behavioral experiments, we want to describe the olfactory pathway in *Parhyale hawaiiensis* and give a base line for its behavior regarding olfaction. The resulting data will serve as base for our comparative study about the evolution of crustacean and hexapod (Dr. Jürgen Rybak, Eleftherios Dimitriou, MPI for Chemical Ecology Jena) olfactory core circuits using computational modeling (Prof. Martin Nawrot, Magdalena Springer, Computational Systems Neuroscience, University Cologne).

This study is supported by DFG grant HA2540/20-1 in PP 2205 “Evolutionary Optimization of Neuronal Processing”

SNMP1 is critical for sensitive pheromone detection and pheromone-controlled behaviors in the desert locust *Schistocerca gregaria*

Joris Lehmann¹, Johanna Libnow¹, Maryam Khosravian¹, Hetan Chang², Markus Knaden², Bill S. Hansson², Jürgen Krieger¹, Jörg Fleischer¹

¹Martin Luther University Halle-Wittenberg, Institute of Biology/Zoology, Department of Animal Physiology, Hoher Weg 8, 06120 Halle (Saale), Germany

²Max Planck Institute for Chemical Ecology, Department of Evolutionary Ecology, Hans-Knöll-Strasse 8, 07745 Jena, Germany

The sensory neuron membrane protein 1 (SNMP1) is co-expressed with given odorant receptors (ORs) in subsets of olfactory sensory neurons (OSNs) in the antennae of insects. Previous studies in holometabolous flies and moths have indicated that SNMP1 may act as a co-receptor facilitating ultrasensitive pheromone detection in concert with given ORs and is required for proper pheromone-controlled behavior. However, the function of SNMP1 in hemimetabolous insects has not been studied. Here, we set out to address the relevance of SNMP1 for pheromone detection and behavior in an important hemimetabolous pest insect, the desert locust *Schistocerca gregaria*. Towards this goal, using the CRISPR/Cas technology, we generated a mutant knockout line to investigate the relevance of SNMP1 for detecting phenylacetonitrile (PAN), a male courtship inhibition pheromone in *S. gregaria* signaling male identity of its releaser. In electroantennogram (EAG) recordings, we found significantly reduced EAG responses in mutant versus wildtype animals over a broader range of amounts of PAN used for stimulation. In addition, single sensillum recordings with basiconic sensilla on the antenna revealed a significantly lower spike frequency upon PAN-induced stimulation in the SNMP1 mutants. These electrophysiological findings support the notion that SNMP1 is substantial for sensitive detection of PAN in desert locusts.

To address the question whether sensitive PAN detection in *S. gregaria* is critical for PAN-controlled behavior, experiments were conducted in which the pairing of male and female animals was analyzed. In a first approach, couples of females and males were separated, the pronotum of females was painted with PAN (10%) to mimic male identity, and the initial pairs were allowed to mate again. In contrast to wildtype conspecifics, mutant males did not significantly avoid re-pairing with females treated with the courtship inhibition pheromone PAN. In a second behavioral approach, a male was allowed to choose between a female painted with PAN and a female without this treatment. When a PAN concentration of 10% was utilized, both wildtype and mutant males preferred non-treated females. However, when a concentration of 1% PAN was applied, in marked contrast to their wildtype conspecifics, mutant males did not prefer untreated females, suggesting that they are indeed handicapped in sensitive PAN detection. In summary, our findings indicate that SNMP1 is important for sensitive responses to PAN in antennal OSNs and critical for appropriate PAN-evoked behaviors in the desert locust.

Social flexibility and olfactory processing in the desert locust

Inga Petelski^{1,2,3,4}, Yannick Guenzel^{1,2,3,4}, Sercan Sayin^{1,2,3}, Einat Couzin-Fuchs^{1,2,3}

¹University Konstanz, Neurobiology, Universitätsstrasse 10, 78464 Konstanz, Germany

²Centre for the advanced study of behavior, Universitätsstrasse 10, 78464 Konstanz, Germany

³Max Planck institute of animal behavior, Universitätsstrasse 10, 78464 Konstanz, Germany

⁴International Max Planck research school for organismal biology, Hofgartenstrasse 8, 80539 München, Germany

Flexibility in social foraging behavior allows animals to maximize foraging success in nutritionally unpredictable environments. The desert locust *Schistocerca gregaria* exhibits one of the most extreme examples of this flexibility. Usually, solitary locusts populate sparse landscapes at low densities and forage alone. However, under suitable conditions, mediated by an increase in density of surrounding conspecifics, locusts gradually

convert into a gregarious phase. The transition to group foraging entails considerable changes in the type, quality, and quantity of sensory information available to individual animals. In addition to personally acquired evidence, gregarious locusts have access to a plethora of social information, allowing them to integrate socially derived clues on the location and quality of a food source. How does the social context, such as the smell of conspecifics, guide animals in their foraging campaigns? Are there sensory differences between the two phases? We address these questions by investigating the early olfactory processing of food odor cues in the presence and absence of the colony smell via calcium imaging of antennal lobe projection neurons in gregarious and solitary animals. We demonstrate that a simulated olfactory group context increases the overall magnitude of projection neuron activity to food odorants in gregarious animals. This social modulation is phase-dependent and does not occur in solitary animals, suggesting it to be a potential adaptation of the olfactory system to facilitate or promote foraging in a group.

Spike Frequency Modulation of Central Neurons in the Primary Olfactory Pathway of Insects

Jan Erik Radermacher¹, Debora Fusca¹, Svenja Corneliussen¹, Jonas M Klußmann¹,
Peter Kloppenburg¹

¹Biocenter, Institute for Zoology, Cologne Excellence Cluster on Cellular Stress Responses in Aging-Associated Diseases (CECAD) and Center for Molecular Medicine Cologne (CMMC) University of Cologne, Cologne, Germany.

In the insect antennal lobe, which is the functional equivalent of the vertebrate olfactory bulb, cholinergic uniglomerular projection neurons (uPNs) and GABAergic multiglomerular local interneurons (LNs) each have specific physiological tasks during odor processing. The odor responses of these neurons are influenced by synaptic input and their intrinsic electrophysiological properties. This study aims to thoroughly define the intrinsic electrophysiological properties of uPNs and LNs and the underlying ionic current profiles that enable the neurons to perform their specific tasks during odor information processing. Using defined current- and voltage-clamp protocols, we found significant cell type-specific differences in the electrophysiological properties. GABAergic LNs generated strong rebound potentials after hyperpolarization, while cholinergic uPNs showed spike frequency acceleration during sustained depolarization. Since the anatomical and morphological organization of the olfactory circuitry is shared between insect species, we also address whether the conserved circuit organization observed between insect species is associated with similar intrinsic electrophysiological properties and ionic mechanisms. For this purpose, the studies are performed comparatively on two evolutionarily distant insect species, the hemimetabolous cockroach *P. americana* and the holometabolous fruit fly *D. melanogaster*.

Supported by DFG grant KL 762 / 10-1 to PK.

State-dependent modulation of odor valence and social behavior via the main olfactory pathway

Annika Cichy¹, Adam Dewan², Jingji Zhang³, Sarah Kaye³, Tiffany Teng³, Kassandra Blanchard³, Paul Feinstein⁴, Thomas Bozza³

¹University of Bonn, Medical faculty, Institute of Physiology II, 53115 Bonn, Germany

²Department of Psychology, Florida State University, Tallahassee, FL 32306, USA

³Department of Neurobiology, Northwestern University, Evanston, IL 60208, USA

⁴The Graduate Center Programs in Biochemistry, Biology and CUNY Neuroscience Collaborative, New York, NY 10016

Mammalian social behaviors such as aggression are influenced by conspecific chemical cues, typically low volatility molecules that activate the vomeronasal pathway. While the main olfactory system is required for proper social behaviors, the molecular basis for how social cues are detected via the main olfactory pathway of mammals is not well-characterized. Trimethylamine is a volatile, sex-specific chemical that is enriched in adult male mouse urine and specifically activates main olfactory sensory neurons that express trace amine-associated receptor 5 (TAAR5). Here we show that trimethylamine, acting via TAAR5, elicits state-dependent attraction or aversion in male and female mice depending on neuroendocrine or social status. Genetic knockout of TAAR5 abolishes valence responses in both sexes and significantly reduces aggression-related behaviors in males, while adding trimethylamine augments aggressive behavior towards juvenile males. We further show that transgenic expression of TAAR5 specifically in olfactory sensory neurons rescues aggressive behaviors in knockout mice, despite extensive remapping of TAAR5 projections to the olfactory bulb. Our results show that state-dependent behavioral responses to a volatile social cue are mediated via the main olfactory pathway, identify a specific main olfactory input (TAAR5) as necessary for intermale aggression, and reveal that apparently innate behavioral responses are independent of patterned glomerular input to the olfactory bulb.

Synaptic mechanisms and their functions for stimulus adaptation in the *Drosophila* olfactory pathway

Sofia C. Brandão¹, Carlotta Martelli¹

¹Johannes Gutenberg University of Mainz, Institute of Developmental Biology and Neurobiology, Hanns-Dieter-Hüsich-Weg 15, 55128 Mainz, Germany

Adaptation is a key mechanism in all sensory systems, allowing neurons to modulate their response so they can appropriately encode the environment's stimulus statistics. The olfactory system of the fruit fly *Drosophila melanogaster* is no exception: if the dendritic response of olfactory receptor neurons (ORNs) is measured in the antennae by single sensillum recordings, adaptation is observed, since these neurons decrease their dendritic response to an odor after adaptation to a background of the same odor.

Each ORN expresses one or a few chemosensory receptors and projects its axon to a single glomerulus in the antennal lobe (AL). In the AL, ORNs synapse onto projection neurons (PNs) that relay odor information to higher brain regions and to local neurons (LNs) that couple and modulate the different glomeruli, mainly through lateral inhibition. If the response of ORNs is measured in their axons by expressing a genetically-encoded calcium reporter, adaptation is no longer observed: the response to a pulse is identical whether it is delivered isolated or after a background.

Here we investigate the mechanisms that transform an adaptive firing rate response into non-adaptive synaptic activity and what role it has in odor coding for different adapted conditions. We block synaptic output from ORNs using *shibire(ts)*, in order to interfere with lateral inhibition from local neurons (LNs) and feedback modulation from projection neurons (PNs), and measure responses in the ORNs themselves. With this intervention, ORNs show adaptation to a background, indicating that cell-extrinsic mechanisms that require input from ORNs are responsible for ORNs' axonal lack of adaptation. To clarify what is the output of the antennal lobe in terms of adaptation, we quantify responses in PNs' dendrites. We show that PN responses are transient due to synaptic depression, but nonetheless they do not adapt to a background. We discuss what mechanisms could be responsible for such synaptic plasticity. Finally, we use a computational model to show how adaptation of single ORNs supports contrast coding at the population level and discuss what are the consequences for odor-driven behavior.

References:

- Benda, J. (2021). Neural adaptation. *Current Biology*, 31(3), R110–R116.
- Brandão, S. C., Silies, M., & Martelli, C. (2021). Adaptive temporal processing of odor stimuli. *Cell and Tissue Research*, 383, 125–141.
- Martelli, C., & Fiala, A. (2019). Slow presynaptic mechanisms that mediate adaptation in the olfactory pathway of *Drosophila*. *ELife*.
- Nagel, K. I., & Wilson, R. I. (2011). Biophysical mechanisms underlying olfactory receptor neuron dynamics. *Nature Neuroscience*, 14(2), 208–216.
- Wilson, R. I. (2013). Early Olfactory Processing in *Drosophila*: Mechanisms and Principles. *Annual Review of Neuroscience*, 36, 217–241.

The larval sensory system: From structure to function

Vincent Richter¹, Anna Rist², Anton Miroschnikow³, Michael J. Pankratz³, Albert Cardona⁴, Michael Laumann⁵, Andreas S. Thum^{1,2,6}

¹Leipzig University, Genetics Department, Talstraße 33, 04318 Leipzig, Germany; ²University of Konstanz, Konstanz, Germany;

³Department of Molecular Brain Physiology and Behavior, LIMES Institute, University of Bonn, Bonn, Germany; ⁴Department of Physiology, Development and Neuroscience, University of Cambridge, Cambridge, United Kingdom; ⁵Electron Microscopy Center, University of Konstanz, Konstanz, Germany; ⁶Zukunftskolleg, University of Konstanz, Konstanz, Germany

Sensory perception is the ability through which an organism is able to process sensory stimuli from the environment. This stimulus is transmitted from the peripheral sensory organs to the central nervous system, where it is interpreted. *Drosophila melanogaster* larvae possess peripheral sense organs on their head, thoracic, and abdominal segments. These are specialized to receive diverse environmental information, such as olfactory, gustatory, temperature or mechanosensory signals. In this work, we complete the description of the morphology of external and pharyngeal larval sensilla and provide a complete map of the ultrastructure of the different types of sensilla that comprise them. This was achieved by 3D electron microscopic analysis of partial and whole body volumes, which contain high-resolution and complete three-dimensional data on the anatomy of the sensilla and adjacent ganglia.

Our analysis revealed three main types of sensilla on thoracic and abdominal segments: the papilla sensillum, the hair sensillum and the knob sensillum. They occur either solitary or organized in compound sensilla such as the thoracic Keilin's organ or the terminal sensory cones. We present a spatial map defining these sensilla by their position on thoracic and abdominal segments. Further, we identify and name the sensilla located at the larval head, the last fused abdominal segments and the pharyngeal region. We show that mechanosensation dominates in the larval peripheral nervous system, as most sensilla have corresponding structural properties. The result of this work, the construction of a complete structural and neuronal map of the larval sensilla, provides the basis for following molecular and functional studies to understand which sensory strategies the *Drosophila* larva employs to orient itself in its natural environment.

The mushroom body output encodes behavioral decision during sensory-motor transformation

Cansu Arican¹, Felix Johannes Schmitt¹, Wolfgang Rössler², Martin Fritz Strube-Bloss³,
Martin Paul Nawrot¹

¹Computational Systems Neuroscience, Institute of Zoology, University of Cologne, Cologne, Germany

²Behavioral Physiology and Sociobiology (Zoology II), Biozentrum, University of Würzburg, Würzburg, Germany

³Department of Biological Cybernetics and Theoretical Biology, University of Bielefeld, Bielefeld, Germany

Animals form a behavioral decision by evaluating sensory evidence on the background of past experiences and the acute motivational state. In insects, the mushroom body (MB) has repeatedly been implicated in assessing the appetitive or aversive valence of the sensory stimulus to bias approach versus avoidance behavior, both in naïve and trained animals. To study the MB involvement in innate feeding behavior we performed extracellular single-unit recordings from MB output neurons (MBONs) while simultaneously monitoring a defined feeding behavior in response to timed odor stimulation in naïve American cockroaches. All animals expressed the feeding behavior almost exclusively in response to food odors. Likewise, MBON responses were invariably and strongly tuned to the same odors. Importantly, MBON responses were restricted to behaviorally responded trials, which allowed the accurate prediction of the occurrence versus non-occurrence of the feeding behavior from the neuronal population activity. During responded trials the neuronal activity generally preceded the onset of the feeding behavior, indicating a causal relation. We conclude that the recorded MB output population dynamically encodes the behavioral decision to inform downstream motor networks.

The neuronal logic of how internal states control food choice

Daniel Münch¹, Dennis Goldschmidt¹, Carlos Ribeiro¹

¹Fundação Champalimaud, Behavior and Metabolism Laboratory, Avenida Brasília, 1400-038 Lisboa, Portugal

When deciding what to eat, animals evaluate sensory information about food quality alongside multiple ongoing internal states. How internal states interact to alter sensorimotor processing and shape decisions such as food choice remains poorly understood. Here we use pan-neuronal volumetric activity imaging in the brain of *Drosophila melanogaster* to investigate the neuronal basis of internal state-dependent nutrient appetites. We created a functional atlas of the ventral fly brain and find that metabolic state shapes sensorimotor processing across large sections of the neuropil. By contrast, reproductive state acts locally to define how sensory information is translated into feeding motor output. These two states thus synergistically modulate protein-specific food intake and food choice. Finally, using a novel computational strategy, we identify driver lines that label neurons innervating state-modulated brain regions and show that the newly identified 'borboleta' region is sufficient to direct food choice towards protein-rich food. We thus identify a generalizable principle by which distinct internal states are integrated to shape decision making and propose a strategy to uncover and functionally validate how internal states shape behaviour.

The role of SNMP2 in the olfactory processes of moths

Sina Cassau¹, Jürgen Krieger¹

¹Martin Luther University Halle-Wittenberg, Institute of Biology/Zoology, Department of Animal Physiology, Hoher Weg 8, 06120 Halle (Saale), Germany

Insects detect behaviorally relevant odorants via olfactory sensory neurons (OSNs) that extend their dendrites into lymph-filled, hair-like structures on the antenna, called sensilla. At the base of a sensillum OSNs are enveloped by support cells (SCs), which control the composition of the lymph. OSNs and SCs express the proteins necessary for the proper detection of olfactory cues. These include so-called sensory neuron membrane proteins (SNMPs) representing insect-specific members of the vertebrate CD36 family of lipid receptors and transporters. In moths, the SNMP1 type is exclusively expressed in OSNs and implicated as a co-receptor acting in the sensitive detection of pheromones. In contrast, the function of the SNMP2 type is unknown, and in conflict with its name SNMP2 is solely expressed in non-neuronal SCs. We recently localized the SNMP2 protein at the apical membrane of SCs facing the sensillum lymph. This, together with its CD36 family membership, led to the concept that SNMP2 might function as transporter that acts in sensillum lymph maintenance processes by removing lipophilic “waste products” stemming from degraded odorants. In order to investigate this concept, we examined the uptake of lipophilic fluorescent fatty acid (FA) analogs mimicking degraded pheromones in a cell line stably expressing the SNMP2 of *Heliothis virescens*. In live cell imaging experiments we found a rapid and increased uptake of long chain FA analogs in SNMP2 expressing cells, which was significantly reduced in the presence of the CD36-protein inhibitor (SSO). Furthermore, incubating the antennae of the moths *H. virescens* and *Bombyx mori* with these FA analogs, we revealed fluorescence signals only in the non-neuronal SCs, which were reduced by preincubating antenna with SSO. Together these results indicated that SCs can take up lipophilic compounds from the sensillum lymph and suggests an involvement of SNMP2 in this process. To approach the consequences of a disturbance in SC/SNMP2-mediated processes for the proper termination of olfactory signaling, we incubated the antenna of *B. mori* males in SSO and monitored their behavioral response to female released pheromones. We found that SSO-treated males show a prolonged “flutter dance” in response to female-emitted pheromones compared to untreated males. We hypothesize that this might result from inhibiting SNMP2-mediated olfactory recovery processes, such as the fast removal of lipophilic pheromone degradation products that in consequence might lead to a blockage of pheromone degradation processes, a resulting persistence of pheromone molecules and a prolonged activation of pheromone-responsive OSNs. Altogether, our data further support the view that SCs and SNMP2 have an important function in olfactory maintenance processes, which are the prerequisite for proper detection of behaviorally relevant odorants.

The search for olfactory receptors tuned to pheromones in the honey bee

Benjamin Andreu¹, Nicolas Montagné², Thomas Chertemps², Emmanuelle Jacquin-Joly³,
David Touboul⁴, Amandine Huebert⁴

¹ Evolution, Genome, Behavior, Ecology, Université Paris-Saclay, CNRS, IRD, Gif-sur-Yvette, France

² Sorbonne Université, Institute for Ecology & Environmental Sciences of Paris, Department of Sensory Ecology, Paris, France

³INRA, Institute of Ecology & Environmental Sciences of Paris, Department of Sensory Ecology, Versailles, France

⁴ICSN, Institute of Chemistry of Natural Substances, Gif-sur-yvettes, France

Being social insects, honeybees use pheromones to ensure intraspecific communication allowing colony cohesion in a wide range of contexts: queen retinue, brood care, foraging, colony defense, swarming, etc. Honeybees constitute an interesting model to study the neurobiological basis of pheromonal processing, as the anatomy of the honey bee brain has been well characterized. Despite increasing knowledge already acquired on olfactory processing in this species, the nature of pheromonal coding is still poorly understood. Knowledge from other insects suggest that pheromones would be detected and processed by highly specific and isolated subsystems (“labeled lines”) while general odorants would be encoded in a combinatorial fashion (“across fiber pattern”). But, with a such a plethora of different pheromonal compounds, more than most insects, can the bee brain really harbor as many labeled lines? Or did this social insect evolve a more cost-effective strategy using combinatorial coding of pheromone information? To answer these questions, we study the responses of individual olfactory receptors and attempt to determine their ligands (receptor deorphanization). To this aim, we use heterologous expression in the “empty neuron system” of *Drosophila*, coupled to transcuticular calcium imaging. We will present here the work that lead to the identification of ligands for a first olfactory receptor in our panel. Once the ligands of each receptor are identified, we will study their neural representations in the honey bee brain using *in vivo* calcium imaging, aiming to produce a complete picture of the circuits involved in pheromone processing in this social insect.

The Sensilla-Specific Expression and Subcellular Localization of SNMP1 and SNMP2 Reveal Novel Insights into their Roles in the Antenna of the Desert Locust *Schistocerca gregaria*

Jürgen Krieger¹, Doreen Sander¹, Angelina Degen¹, Thomas Karcher^{1,2}, Stephanie Krüger³, Michael Laue⁴, Gerd Hause⁵, Heinz Breer⁶, Sina Cassau¹

¹Martin Luther University Halle-Wittenberg, Institute of Biology/Zoology, Department of Animal Physiology, Hoher Weg 8, 06120 Halle (Saale), Germany

² present address BMG Labtech GmbH, 77799 Ortenberg, Germany

³Martin Luther University Halle-Wittenberg, Institute of Biology/Zoology, Department of Developmental Biology, 06120 Halle (Saale), Germany

⁴Advanced Light and Electron Microscopy, Centre for Biological Threats and Special Pathogens 4 (ZBS 4), Robert Koch Institute, 13353 Berlin, Germany

⁵Martin Luther University Halle-Wittenberg, Biocenter, Electron Microscopy Unit, 06120 Halle (Saale), Germany

⁶University of Hohenheim, Institute of Physiology, 70599 Stuttgart, Germany

The desert locust, *Schistocerca gregaria*, can form dreaded swarms of millions of individuals that can destroy the vegetation and crops of complete landscapes. In locust, reproduction, aggregation and food search behaviors are controlled by complex olfactory signals. Odorant detection is achieved via different types of olfactory sensilla on the antenna that house olfactory sensory neurons (OSN) and associated support cells (SCs), both of which express the proteins required for olfactory signaling. Among these proteins, two members of the CD36 lipid transporter/receptor family, named sensory neuron membrane proteins 1 and 2 (SNMP1 and SNMP2), are indicated to be of vital importance. While SNMP1 is considered to act as a coreceptor in the OR-mediated detection of pheromones, SNMP2 was found to be expressed in SCs; however, its function is unknown. Towards a better understanding of the role of the two SNMPs in the olfactory system of *S. gregaria*, we have analysed their antennal topography and subcellular localization using specific antibodies. Through fluorescence immunohistochemistry (FIHC) we found SNMP1 in the somata and respective dendrites of all OSNs in trichoid sensilla and in subsets of OSNs in basiconic sensilla. Notably, SNMP1 was also detected in SCs of these sensilla types. In contrast, SNMP2 protein was only visualized in SCs of basiconic and coeloconic sensilla. This expression pattern of the two SNMPs is established already in first instar nymphs of the hemimetabolous insect and retained throughout development. Exploring the subcellular localization by electron microscopy using anti-SNMP1 and anti-SNMP2 antibodies revealed an immunogold labelling of SC microvilli bordering the sensillum lymph. Together our findings suggest a dual role of SNMP1 in the antenna of *S. gregaria*, in some OSN subpopulations in odor detection as well as in functions of some SCs. In contrast, SNMP2 was found solely in support cells and their microvilli membranes, suggesting a role limited to sensillum lymph recovery processes.

Whole brain representation of odor and taste and their integration in the adult fly

Paul Bandow^{1,2}, Sophie Aimon³, Ilona C. Grunwald Kadow^{1,2}

¹Institute of Physiology II, Faculty of Medicine, University of Bonn, Germany

²GSN, Ludwig-Maximilians-University, Munich, Germany

³Max Planck Institute for Biological Cybernetics, Tübingen, Germany

Chemosensation, the sense of smell and taste, is an essential tool for most animals, including humans, for finding and evaluating possible food sources not only with respect to their edibility but also their nutritious value. Hence, odorants and tastants often have intrinsic valence which means that they are perceived as either positive or negative and can cause innate attraction or aversion.

Using in vivo whole brain light field imaging in the adult fruit fly (*D. melanogaster*). We have investigated how neurons respond to odor and taste of different valence on a brain wide level. The peripheral perception of this sensory inputs has been studied intensively, yet how these signals are encoded in higher brain centers, is still poorly understood, especially in gustation. How odor and taste is combined in the brain is even less understood. Since it has been demonstrated that the valence of a stimulus can be modulated by the metabolic state of the animal, we further examined which brain regions are influenced in their odor or taste responses by starvation.

In order to study this, we expressed the calcium-sensitive protein GCamp pan-neuronally in all neuronal cells. We recorded the Ca²⁺-dependent changes in fluorescence with high temporal resolution using a custom-build light field microscope (LFM) and reconstructed a three-dimensional image of neuronal responses to odors and tastes of the whole brain. With this approach, we analyzed valence-coding and integration of sensory stimuli on a global scale.

We have imaged both fed and starved flies and exposed them to different odor and taste substances. We analyzed the peak responses in twelve major brain areas and found that depending on the sensory modality, the response is highly region-specific. Odors elicited high responses in the lateral horn (LH), the mushroom bodies (MB) as well as the superior neuropils (SNP), whereas tastants strongly activated the gnathal ganglia (GNG). Moreover, we found that starvation increases the response to appetitive odors and in contrast reduces the response to non-appetitive tastes in multiple brain regions. This suggests that metabolic state modulates olfactory and gustatory circuits in different ways. When pairing a taste with an odor stimulus, both odor and taste responsive regions were activated simultaneously. We found that pairing an appetitive odor with a bitter taste results in higher responses brain-wide, especially in fed flies. This suggests that brain activity during multisensory integration of chemosensory stimuli is influenced by valence information and the internal state.

In a second step, we are analyzing this data set, using independent component analysis (ICA) in order to identify functional subregions for multisensory and metabolic state integration that show highly correlated activity in response to the stimulus with the aim of mapping them to anatomical subregions, neural tracts or even individual neurons. We aim at creating a functional map across the whole fly brain that illustrates the neural circuits involved in integration of taste and odor as well as metabolic state, based on our in vivo experiments.

Binge eating suppresses flavor representations in the mouse olfactory cortex

Hung Lo^{1,2}

¹Charité – Universitätsmedizin Berlin, corporate member of Freie Universität Berlin and Humboldt-Universität zu Berlin, Neuroscience Research Center, Berlin, Germany

²Charité – Universitätsmedizin Berlin, corporate member of Freie Universität Berlin and Humboldt-Universität zu Berlin, Einstein Center for Neurosciences Berlin, Berlin, Germany

³Institut für Biologie, Humboldt Universität zu Berlin, Berlin, Germany

⁴Cognitive Neurobiology, Humboldt Universität zu Berlin, Berlin, Germany

⁵Charité – Universitätsmedizin Berlin, corporate member of Freie Universität Berlin and Humboldt-Universität zu Berlin, NeuroCure Cluster of Excellence, Berlin, Germany

⁶Center for Neurodegenerative Diseases (DZNE), Berlin, Germany

Appropriate feeding behavior is the foundation of maintaining homeostasis. Elevated feeding rate (binge eating) is a common trait of eating disorders, and it is associated with obesity. It is also known that flavor perception has an active role in regulating feeding. However, the effects of feeding rate on flavor sensory feedback remain unknown. We developed a liquid food delivery system that mice can consume flavored milk with different feeding rates, e.g., slow eating mode (4-second interval) and binge eating mode (0.4-second interval). Using miniscope in mice, we showed that binge eating suppresses neuronal activity in the anterior olfactory (piriform) cortex (aPC), while slow eating does not. The strength of binge-induced suppression in the aPC predicts animals' consumption and duration of feeding. This binge-induced suppression is only observed in aPC, not in gustatory or somatosensory cortices.

Odor inputs from olfactory bulb mitral cells remain stable upon binge eating, suggesting the suppression is not due to degraded odor inputs. The suppression is also unlikely due to the activation of local GABAergic aPC interneurons (PV⁺ & SST⁺). We further examined the inhibitory effects of dopaminergic and serotonergic modulation in the aPC by using in vivo neuromodulator imaging. Taken together, our results provide clear circuit mechanisms of binge-induced flavor modulation, which may contribute to binge-induced overeating due to reduced sensory feedback of food items.

Binge eating suppresses flavor representations in the mouse olfactory cortex (piriform cortex)

Lo et al., 2022

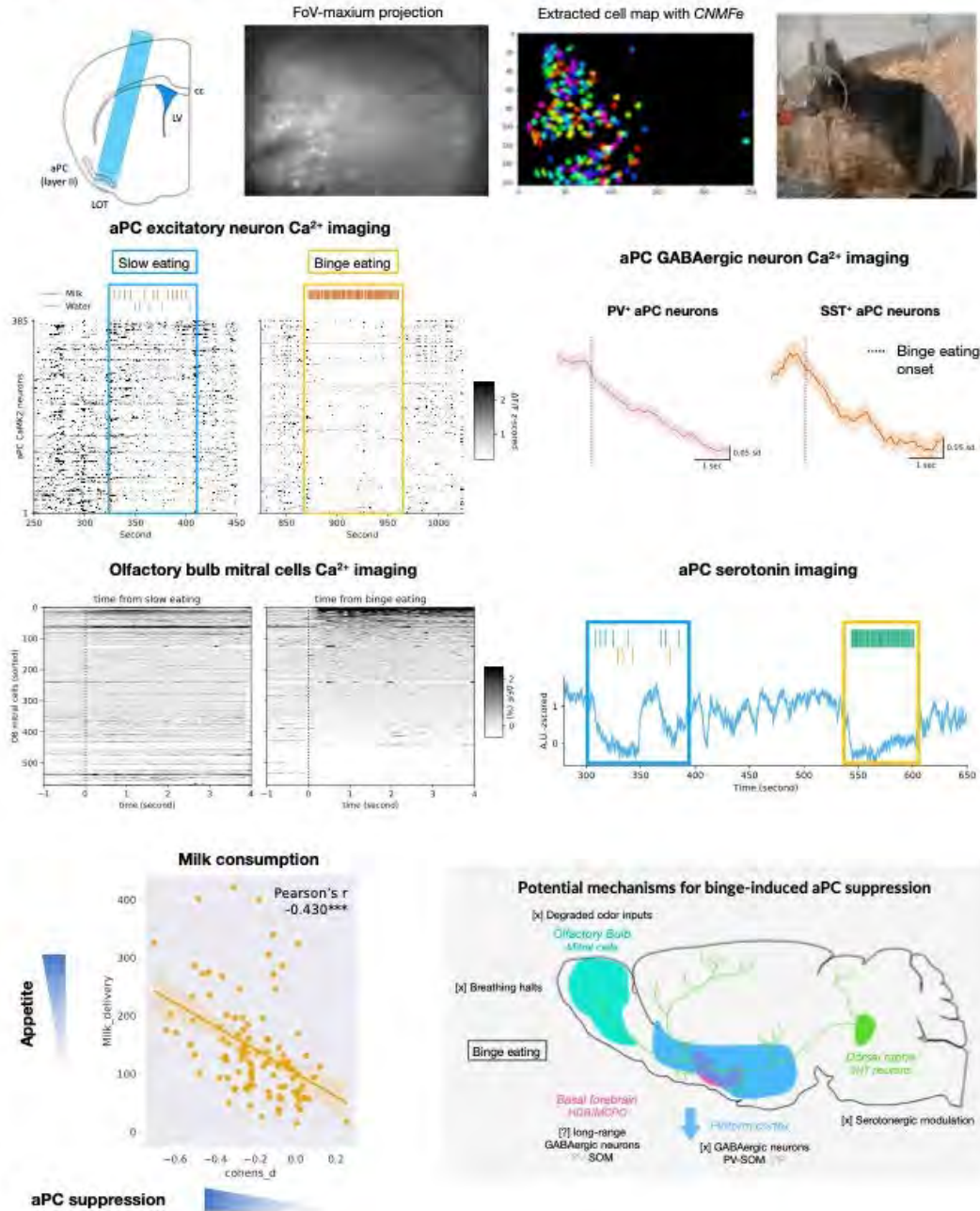

Poster Topic

T20: Somatosensation: Touch, Temperature, Proprioception, Nociception

- [T20-1A](#) Altered Thermoregulation in Adra2b-Null Mice Links to Metabolic Alterations
Xinnan Song, Katharina Zimmermann, Pragyanshu Khare
- [T20-2A](#) Anatomical characterization of *Drosophila melanogaster* ascending neurons conveying somatosensory information from the adult ventral nerve cord to the brain
Massimo Thiel, Erica Ehrhardt, Kei Ito
- [T20-3A](#) Ceramide Synthases: New Players in Pain Signaling?
Oliver Dräger, Marie Bergmeier, Wing-Kee Lee, Erhard Wischmeyer
- [T20-4A](#) Investigating the role of magnetic cues in the neural representation of space in the subterranean mole-rat *Fukomys anselli*
Runita Shirdhankar, Georgina Fenton, Pascal Malkemper
- [T20-1B](#) Leg Campaniform Sensilla Projection Patterns in the Fruit Fly Ventral Nerve Cord
Anna Pierzchlińska, Gesa F. Dinges, Erica Ehrhardt, Till Bockemühl, Kai Feng, Kei Ito, Ansgar Büschges
- [T20-2B](#) FPR2 activation initiates pain resolution and fibrinogen clearance after sciatic nerve injury
Adel Ben Kraiem, Beate Hartmannsberger, Marco Sisignano, Andres. J Garcia, Alexander Brack, Heike Rittner, Alexander Brack, Heike Rittner
- [T20-3B](#) Role of Leg-Campaniform sensilla in fruit fly curve walking
Ricardo Duarte Custódio, Axel Gorostiza, Till Bockemühl, Ansgar Büschges
- [T20-4B](#) Role of the molecular mediator Lrg1 in persistent inflammatory pain.
Ann-Kristin Kenkel, José Ricardo Vieira, Christian Litke, Andromachi Karakatsani, Carmen Ruiz de Almodóvar, Daniela Mauceri
- [T20-5B](#) Magnetoreception in laboratory mice
Li Zhang, Brittany Hamauei, Georgina Fenton, Runita Narendra Shirdhankar, Martha Daniel, Pascal Malkemper
- [T20-1C](#) Stress during adolescence as a predisposing factor for low back pain in adulthood
Deepika Singhal, Rolf-Detlef Treede

[T20-2C](#) The Effects of Developmental Temperature on Adult Behavior in Flies and Ants
Jana Mach, P. Robin Hiesinger

[T20-3C](#) VIP-to-SST circuit motif shows differential short-term plasticity across sensory areas of mouse cortex
Jenifer Rachel, Martin Möck, Mirko Witte, Jochen F Staiger

[T20-4C](#) Voluntary passive movement – do flies play?
Wolf Huetteroth, Tilman Triphan

Altered Thermoregulation in Adra2b-Null Mice Links to Metabolic Alterations

Xinnan Song¹, Katharina Zimmermann¹, Pragyanshu Khare¹

¹Friedrich-Alexander-University Erlangen-Nürnberg, Department of Anesthesiology, AG Zimmermann, Krankenhausstraße 12, 91054 Erlangen, Germany

The adrenoceptor alpha-2b (Adra2b, $\alpha 2B$) is a subtype of $\alpha 2$ -adrenergic receptors, amongst the highly homologous $\alpha 2A$, $\alpha 2B$, and $\alpha 2C$ variants. In vessels, $\alpha 2B$ mediates vasoconstriction and contributes to the peripheral regulation of vascular tone. Loss of $\alpha 2B$ results in peripheral nitric oxide synthase inhibition, which is an important factor mediating peripheral vascular tone during thermal stress. However, high-fat diet feeding increases the mRNA expression of hypothalamic $\alpha 2B$, and the importance of peripheral vascular tone in energy homeostasis is well evident but the direct evidence-demonstrating role of Adra2b in thermal preference and thermoregulatory behavior along with their metabolic phenotyping is missing. Here, we assessed the thermal preference behavior and metabolic profile of Adra2b-null mice at different ambient temperatures. We used 8-10 week-old male Adra2b-null mice (N=25) and their wild-type littermates (N=25), bred and raised in single genotype cages and housed at 22 ± 2 °C. For the assessment of thermal preference behavior, we used Zimmermann's Thermal Gradient Ring (TGR) assay. In this assay, individual mice were placed in a circular running track with floor temperature equilibrated in temperature ranges from 5-30 °C and 15-40 °C, imaginary divided into 12 equal zones. The thermoneutral zone (TNZ) was then determined using thermography according to Romanowsky's assay where the mice were held in restrainers and exposed to constant temperatures ranging between 22-34 °C (N=6). Finally, food intake and locomotor activity were measured at different temperatures using Promethion apparatus. In the TGR assay, weighted preference temperature was not significantly different between WT and Adra2b-null mice in both the gradient protocols i.e., 5-30 °C (27.13 ± 0.18 vs 27.61 ± 0.25 °C) and 15-40°C (29.59 ± 0.17 vs 29.53 ± 0.11 °C). Similarly, no significant differences in other parameters were observed during 1st 30 min in both protocols. However, during the 5-30 °C gradient, a larger cold tolerant behavior of Adra2b-null mice was observed during the last 30 min of the experiment. In this period, WT mice stayed significantly away from 18.6-25.5 °C (18.6 °C ($p=0.049$), 20.9 °C ($p=0.029$), 23.2 °C ($p=0.019$), and 25.5 °C ($p=0.027$)) as compared to Adra2b-null mice. Furthermore, in contrast to Adra2b-null mice, WT mice showed a clear preference for 30 °C over 28°C. In the 15-40°C gradient setup, Adra2b-null mice showed less avoidance response from 35.5 to 40.0 °C compared to their WT littermates. TNZ for WT mice was in the range of 30.5-33.5 °C while TNZ for Adra2b-null mice was in the range of 31-34.5 °C. Adra2b-null mice showed significantly less vasodilation as compared to their WT littermates at 32 °C ($p<0.001$), 33°C ($p=0.005$) and 34 °C ($p=0.002$). In line with the shift in TNZ, Adra2b-null mice had significantly less body weight (26.87 ± 0.57 vs 32.56 ± 0.36 , $p=0.003$) after reaching the age of 15-16 weeks, which was not observed initially at the age of 8-10 week. Similar to the thermal preference behavior at 28 °C and 30 °C, the WT mice showed differential food intake and locomotor activity while the Adra2b-null mouse did not show any significant difference at these temperatures. Taken together, our data illustrate that Adra2b-null mice showed impaired thermoregulatory behavior, and an increase in TNZ, which might be a contributing factor to their lower body weight due to temperature-induced alteration in food intake and locomotor activity.

Anatomical characterization of *Drosophila melanogaster* ascending neurons conveying somatosensory information from the adult ventral nerve cord to the brain

Massimo Thiel¹, Erica Ehrhardt², Kei Ito³

¹University of Cologne, Institute of Zoology, AG Ito, mthiel6@smail.uni-koeln.de

²University of Cologne, Institute of Zoology, AG Ito, eehrhard@uni-koeln.de

³University of Cologne, Institute of Zoology, AG Ito, k.ito@uni-koeln.de

The systematic analysis of individual ascending neurons (ANs) based on anatomical data is crucial for the understanding of neuronal circuits that influence locomotion to respond adaptively to the environment. The central nervous system of the fruit fly *Drosophila melanogaster* consists of 2 parts: the brain in the head and the ventral nerve cord (VNC) in the body. For locomotion control, information and feedback from mechanosensory neurons projecting to the VNC is needed and must be transmitted to the brain. The campaniform sensilla (CS) encodes mechanical load by detecting deformation of the cuticular exoskeleton, whereas the chordotonal organ (CO) detects multiple features of joint kinematics, tension or vibration. External sensilla (ES) detects movement of the bristles caused by wind or by contact, gustatory sensilla (GS) detects food signals, stretch receptor (SR) detects tension and stretch between neighbouring leg joints, and multidendritic neuron (MD) detects diverse stimuli such as pain, temperature and touch. Here we used Multicolor flip-out (MCFO) stochastic single-cell labelling light microscope data to create a map of ANs receiving somatosensory information in the VNC and projecting to the brain. An advantage of light microscopy data is the visualization of arborization patterns of the same neuron sample in both the VNC and the brain.

Comparing single neuron images in 3D, we have identified more than 425 types of ANs; we are subsequently classifying them based on their overall morphology, VNC sensory and motor input, axon trajectory, and targets in the brain to establish a map of ANs in the adult fruit fly. Many of the analyzed ANs innervate bilaterally and intersegmentally. The top 5 most innervated brain regions are: gnathal ganglia (GNG), saddle (SAD), wedge (WED), anterior ventrolateral protocerebrum (AVLP), and vest (VES). AN types that have similar arborizations in the VNC, thus receiving similar input, sometimes have different targets in the brain; information conveyed by these ANs can diverge to multiple brain parts. Some other AN types have different arborizations in the VNC, thus receiving different inputs, but target the same brain compartment; multimodal information from these ANs will converge there. ANs receiving input from leg CO and leg CS terminate both within AVLP; multimodal CO+CS ANs tend to terminate in the posterior AVLP and the ANs specialised for CO tend to terminate in the anterior AVLP but broader regions than the CO+CS ones; there is still an overlap between the two groups. Such complex convergence and divergence suggest the need of simultaneous integration of somatosensory information for locomotor flexibility and adaptive behavior. GNG is the most innervated neuropile by ANs and integrate information from the leg neuropil, wing neuropil and haltere neuropil. This suggests that its function is very important for the signalling between the brain and the VNC.

Ceramide Synthases: New Players in Pain Signaling?

Oliver Dräger¹, Marie Bergmeier², Wing-Kee Lee², Erhard Wischmeyer¹

¹Department of Cellular Neurophysiology, Medical School OWL, Bielefeld University, Bielefeld, Germany.

²Department of Physiology and Pathophysiology of Cells and Membranes, Medical School OWL, Bielefeld University, Bielefeld, Germany.

The TWIK-related spinal cord potassium channel (TRESK), a member of the two-pore domain potassium channel family, has been implicated in pain disorders and nociception. Previous studies identified mutations in the TRESK gene leading to increased neuronal excitability in sensory neurons by inhibiting calcium and sodium ion currents mediated by the transient receptor potential vanilloid (TRPV) 1 channel. Furthermore, it has been shown that the lipid composition of plasma membranes could alter ion channel activity. Levels of the sphingolipid sphingomyelin, a major component of the plasma membrane, are directly regulated by its precursor, ceramide. We hypothesized that TRESK activity can be influenced by changes to its lipid microenvironment through ceramide synthases (CerS). To this end, expression studies to investigate a putative link between TRESK and neuron-specific CerS were performed. CerS1 mRNA expression is significantly lower in mouse dorsal root ganglion (DRG) tissue compared to spinal cord (SC) neuronal tissue. TRESK overexpression downregulated CerS1 mRNA in HEK293 and F11 cells, respectively, as well as decreasing TRPV1 and increasing calcitonin gene-related peptide (CGRP) mRNA in F11 cells. Additionally, TRESK overexpression significantly decreased cell viability and proliferation rates as determined in both cell lines. In future studies, electrophysiological measurements using whole-cell patch clamp recordings will be used to investigate effects of CerS1 on ion currents in HEK293-TRESK and the generation of action potentials in F11 cells. Because of its differential expression in DRGs compared to SC neuronal tissue and its downregulation in TRESK overexpressing HEK and F11 cells, we suggest a possible role of CerS1 in DRGs and pain signaling.

Investigating the role of magnetic cues in the neural representation of space in the subterranean mole-rat *Fukomys anselli*

Runita Shirdhankar¹, Georgina Fenton¹, Pascal Malkemper¹

¹Max Planck Institute for Neurobiology of Behavior, Neurobiology of Magnetoreception, Ludwig-Erhard-Alle-2, 53175 Bonn, Germany

Navigation requires complex neural mechanisms wherein the ensemble activity of spatially selective cells creates a mental map of the external environment. One of the cell types of this machinery called place cells encodes the location of the animal in the environment by utilizing egocentric and allocentric cues. The subterranean mole-rat *Fukomys anselli* lives in underground tunnels, navigating through a monotonous habitat where external cues used by epigeic animals are scarce. Behavioral studies have, however, demonstrated that mole-rats use the directional component of the Earth's magnetic field for orientation. We, therefore, hypothesize that magnetic cues modulate their spatial representations. To test this hypothesis, we recorded single-unit neuronal activity from the mole-rat hippocampus, a brain region known to contain place cells in other mammalian species. Neural data was recorded while the animals explored a 1D circular arena in total darkness. Cue rotation manipulation of a polarizing magnetic and tactile cue was done between sessions in order to disambiguate the preferred sensory modality that place cells rely on. We found spatially tuned cells in the hippocampus of the mole-rats with representations similar to those observed in other mammalian species and deciphered the role of magnetic and tactile cues in formation of these representations. These findings provide insights into the neural mechanism of navigation in total darkness and the role of magnetoreception in spatial navigation in mammals.

Leg Campaniform Sensilla Projection Patterns in the Fruit Fly Ventral Nerve Cord

Anna Pierzchlińska¹, Gesa F. Dinges², Erica Ehrhardt¹, Till Bockemühl¹, Kai Feng³, Kei Ito¹, Ansgar Büschges¹

¹University of Cologne, Institute of Zoology, Zùlpicher Straße 47b, 50674 Cologne, Germany

²Department of Mechanical and Aerospace Engineering, West Virginia University, Neuro-Mechanical Intelligence Laboratory, 26506-6106 Morgantown, USA

³Queensland Brain Institute, The University of Queensland, Brisbane, QLD 4072, Australia

Walking constitutes a mode of locomotion for many terrestrial animals, including the fruit fly *Drosophila melanogaster*. The locomotor output must be adjusted to current behavioural goals or environmental obstacles. It is well known that peripheral signals sent from sensory organs contribute to coordination within the limb segments – intra-leg coordination, as well as to the temporal and spatial relationship between all six legs – inter-leg coordination (Bidaye et al. 2018).

Campaniform sensilla (CS) are sensory receptors which detect deformations in the exoskeleton (e.g. Dinges et al. 2021). Elastic substructures of CS deform upon changes in force, especially load, which results in sensory discharge, ultimately contributing to the reinforcement or adjustment of locomotor output. The role of CS in walking kinematics was investigated in previous experiments, where optogenetic inhibition of CS subsets in walking flies showed changes in the intra- and inter-leg coordination.

The aim of the presented project is to analyse how sensory information from CS is integrated in the central nervous system of a fruit fly. Using immunohistochemistry, we are able to label single neurons and track their arborisations in the ventral nerve cord. As a result, we note a correlation between the location of CS on the leg and projection patterns of their axon terminals in the nerve cord. We conclude that CS neurons show leg location specific pathways and arborisation, which could suggest differences in their effect exerted on the locomotor output generated during walking.

These data combined with behavioural studies' results will serve our understanding on how differences in the projection patterns of certain classes of sensory receptors affect locomotor activity. It could also shed light onto how the information originating in the sensory organs is integrated with the centrally generated neuronal activity pattern.

This study was supported by DFG grants CRC1451A05 and 233886668/GRK1960 to AP, EE, GD, KI and AB.

References:

- Bidaye SS, et al. Six-legged walking in insects: how CPGs, peripheral feedback, and descending signals generate coordinated and adaptive motor rhythms. *J Neurophysiol* (2018)
- Dinges GF, et al. Location and arrangement of campaniform sensilla in *Drosophila melanogaster*. *J Comp Neurol* (2021)

FPR2 activation initiates pain resolution and fibrinogen clearance after sciatic nerve injury

Adel Ben Kraiem¹, Beate Hartmannsberger¹, Marco Sisignano², Andres. J Garcia³,
Alexander Brack¹, Heike Rittner¹, Alexander Brack¹, Heike Rittner¹

¹University hospital of Würzburg, Department of Anesthesiology and Critical Care, molecular pain research, Oberdürrbacher Straße 6, 97080 Würzburg, Germany

²Pharmazentrum Frankfurt/ZAFES, Institute of Clinical Pharmacology, University Hospital, Goethe-University, D-60590 Frankfurt am Main, Germany

³Petit Institute for Bioengineering and Bioscience, Georgia Institute of Technology, Atlanta, GA 30332

Background: The resolution of pain is a tightly orchestrated process governed by e.g. anti-inflammatory cytokines or certain macrophage and T cells subtypes. Nerve injury leads to neuropathic pain and Wallerian degeneration followed by regeneration and resolution of hypersensitivity in certain types of neuropathies [1]. Peripheral nerves maintain a highly controlled environment which is protected by blood nerve barrier (BNB) consisting of the endoneurial capillaries and the perineurium. Capillaries are sealed by tight junction proteins (TJP) such as claudin-5 (Cldn5). Nerve injury loosens the BNB via downregulation of Cldn5 amongst others. A barrier disruption allows extravasation of elements such fibrinogen inducing neuroinflammation [2]. Specialized proresolving mediators (SPMs) are a family of lipids, lipoxins, resolvins, and maresins responsible for resolution of inflammation [3, 4]. They are also short-term analgesic, and barrierprotective e.g. in lung capillaries in inflammation [5]. Mechanistically, the resolvin RvD1 shields endothelial adherens junction via activation of its receptors formyl peptide receptor 2 (ALX/FPR2) and G protein coupled receptor 32 (GPR32) [6]. We postulated that specific endogenous SPMs are increased during resolution after traumatic neuropathy and local SPM application accelerates resolution of neuropathic pain possibly by barrier resealing.

Methods: Animal experiments were approved by the Regierung von Unterfranken and were conducted according to ARRIVE guidelines. Wistar rats underwent a chronic constriction injury (CCI) [7]. To identify the resolution phase, mechanical and thermal hypersensitivity were measured by von-Frey Hargreaves test as well as functional tests like voluntary wheel running and the catwalk test. TJP as well as SPMs receptors and inflammatory markers were analyzed by RT-PCR, immunostaining and western blot. The metabolome of endogenous SPMs was measured by liquid chromatography tandem mass spectrometry (LC-MS/MS) in. Injections of the FRP2 agonists BML-111 and RvD1 nanoparticles were performed daily for 1 week locally on injury site.

Results: Mechanical and thermal pain thresholds were decreased for six weeks and the resolution takes place between week 3 and week 6, while gait defects persisted. After injury, Cldn5 was downregulated and fibrinogen leaked into the endoneurium. At six weeks fibrinogen is absent from the perineurium. An extensive metabolome analysis of DRG, nerve, spinal cord, and innervated skin documented increased concentration of 15-HETE – a precursor of lipoxin A (LXA4) – at the beginning of resolution. In parallel, its' receptor Fpr2 was upregulated. Local application of BML-111, an Fpr2 agonist, and RvD1 nanoparticles at 18 d after injury fostered pain resolution. This treatment reduced also endoneurial fibrinogen and upregulated Cldn5, CD206 labeling M2 macrophages, as well as tissue plasminogen degrading fibrinogen. Blocking TAM receptors prevented fastened pain resolution via Fpr2 activation.

Conclusion: Certain SPMs fasten pain resolution after nerve injury by fibrinogen clearance from the endoneurium due to multiple parallel mechanisms including anti-inflammation, resealing the endoneurial barrier and fibrinogen degradation.

Role of Leg-Campaniform sensilla in fruit fly curve walking

Ricardo Duarte Custódio¹, Axel Gorostiza¹, Till Bockemühl¹, Ansgar Büschges¹

¹University of Cologne, Institute for Zoology, Ansgar Büschges Lab, Zülpicher Straße 47b, 50674 Köln, Germany

In Neurobiology the act of movement and the perception that an action occurred are essential for most behaviors and ultimately shape how every animal is able to function in the world. In light of this, this project's purpose is to investigate how an organism's nervous system acquires and integrates sensory information to efficiently react to its environment. To achieve this goal, we are investigating, how specific somatosensory information, i.e. signals about load, is sent to nervous centers of the fruit fly *Drosophila melanogaster* (D.mel), how this information is processed herein, and what role load signals play in the generation of adaptive locomotor behavior, e.g. for generating turns in walking.

The sensory organs in question are the campaniform sensilla (CS), mechanoreceptors located throughout the fly's exoskeleton, with approximately 42 sensors in each leg [1].

Preliminary results from the lab (Dinges et al., unpublished) indicate that targeted activation and inhibition of specific leg CSs elicits behavioral effects on walking. Specific kinematic parameters such as leg swing and stance durations were found to be affected.

To further dissect this topic, we study how changes in load, e.g. increase, reflects on locomotor behavior on the context of CS optogenetic manipulation. To do this we use an established approach (Mendes et al.[2]), i.e. adding weight to the fly's notum – and, while specific CS are optogenetically inhibited, quantify changes in kinematic parameters during walking. It is expected that flies will show different kinematic parameters while walking with an increased gravitational load in conditions, when subsets of CS are transiently inactivated. Initial results indicate that leg kinematics during stepping differ between control conditions as compared to when CS are transiently inactivated.

With our approach, we will be able to provide evidence on how CS functionally contribute to motor control in terrestrial locomotion and point out relevant neuronal substrates for this component of proprioception.

This study was supported by DFG grant Bu857/15-1 in the international NeuroNex consortium "C3NS". For further information see Symposium #15.

1. Dinges, G. F. et al. Location and arrangement of campaniform sensilla in *Drosophila melanogaster*. *Journal of Comparative Neurology* 529, 905–925 (2021).
2. Mendes, C. S., Rajendren, S. v., Bartos, I., Márka, S. & Mann, R. S. Kinematic Responses to Changes in Walking Orientation and Gravitational Load in *Drosophila melanogaster*. *PLOS ONE* 9, e109204 (2014).

Role of the molecular mediator Lrg1 in persistent inflammatory pain.

Ann-Kristin Kenkel¹, José Ricardo Vieira^{1,2,3}, Christian Litke¹, Andromachi Karakatsani²,
Carmen Ruiz de Almodóvar^{2,4,5}, Daniela Mauceri^{1,6}

¹ Department of Neurobiology, Interdisciplinary Center for Neuroscience (IZN), Heidelberg University

² European Center for Angioscience, Medical Faculty Mannheim, Heidelberg University, Mannheim, Germany

³ Faculty of Biosciences, Heidelberg University, Heidelberg, Germany

⁴ Institute for Neurovascular Cell Biology, University Hospital Bonn, Bonn, Germany

⁵ Schlegel Chair for Neurovascular Cell Biology, University of Bonn, Bonn, Germany

⁶ Department of Anatomy and Cell Biology, University of Marburg

Chronic pain is a pathological manifestation of neuronal plasticity supported by altered gene transcription in spinal cord neurons that results in long-lasting hypersensitivity. Neuronal plasticity is modulated, among other things, by epigenetic modifications of DNA and chromatin. Prominent epigenetic mediators, regulating the expression of a variety of genes fundamental to a wide range of physiological and pathological neuroadaptations in the central nervous system, are histone deacetylases (HDACs). Recently, the concept that epigenetic regulators might be important in pathological pain has emerged, but a clear understanding of the molecular players involved in the process is still lacking.

Our group recently showed that that long-lasting inflammatory pain cause nuclear export and inactivation of HDAC4 in neurons of spinal cord dorsal horn. Expression of a constitutively nuclear localized HDAC4 mutant impaired the development of mechanical hypersensitivity but left acute and basal sensitivity unaltered. Next-generation bulk RNA-sequencing analysis revealed an inflammation-related, pain-dependent gene program regulated by HDAC4 comprising known and novel mediators of sensitization, including the secreted glycoprotein **leucine-rich α -2 glycoprotein 1 (Lrg1)**, which is known to be involved in signal transduction. In recent years, a rising number of publications have described the role of Lrg1 in several human pathological conditions, particularly cancer, diabetes, endothelial dysfunctions, cardiovascular disease, neurological and inflammatory disorders. Further studies are still necessary to guarantee our current knowledge of Lrg1 function.

Using pharmacological and molecular tools to modulate Lrg1 expression, combined with different pain models of inflammation, in this study we investigated whether Lrg1 expression is linked to and modulates persistent inflammatory pain. Our results might pave the way to novel analgesic therapies by providing fresh molecular targets embodied by Lrg1.

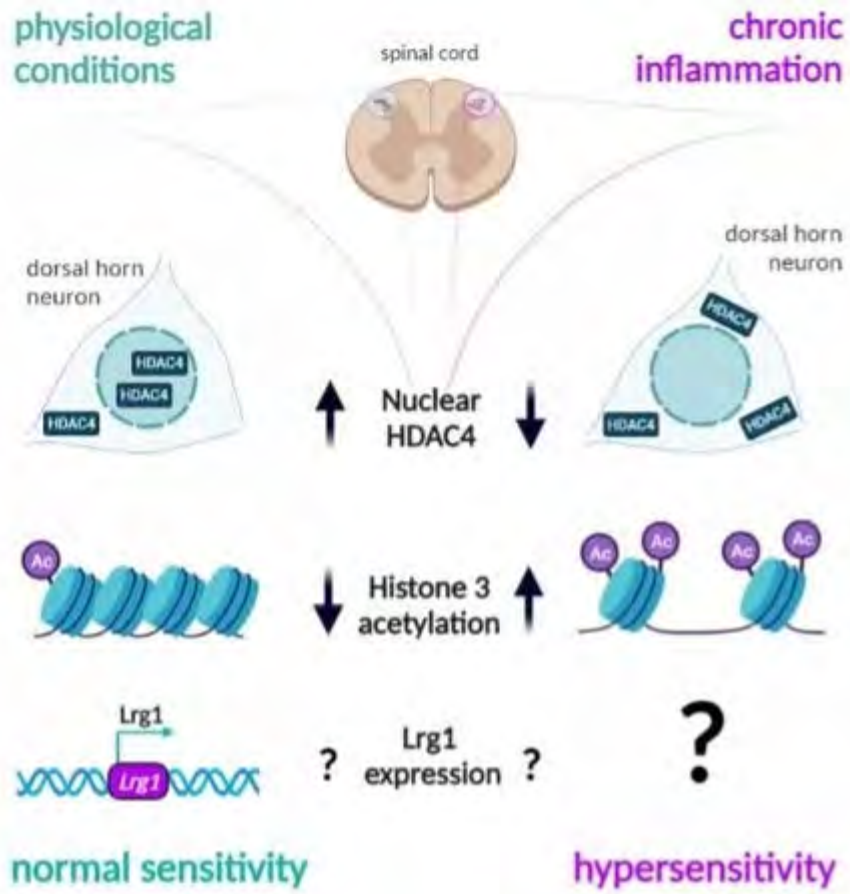

Graphical abstract: Role of the molecular mediator Lrg1 in persistent inflammatory pain: a novel molecular target for analgesic therapies?

Magnetoreception in laboratory mice

Li Zhang¹, Brittany Hamauei¹, Georgina Fenton¹, Runita Narendra Shirdhankar¹, Martha Daniel¹, Pascal Malkemper¹

¹Max Planck Institute for Neurobiology of Behavior – caesar, Neurobiology of magnetoreception, Ludwig-Erhard-Allee 2, 53175 Bonn, Germany

Magnetoreception is prevalent in animals, including insects, birds, fishes, and mammals. Geomagnetic sensing provides them with the necessary geographic location and orientation information to guide survival-related behaviors. Mammalian magnetoreception research, compared with birds, is still in its infancy, and there has been no clear conclusion about the various hypothetical mechanisms of mammalian magnetoreception. This partially results from the limited number of model species available for the study of mammalian magnetoreception, the insufficient number of individuals in non-traditional animal models, and the lack of research tools which may adversely affect the research progress in this field. The laboratory mouse is the most used animal model in neuroscience and it has been suggested to possess a magnetic sense. We, therefore, aimed to establish a robust assay to study magnetoreception in C57BL/6J mice. Here, we present the results of behavioral experiments on the perception of the direction and strength of magnetic fields along with a brain-wide screen for magnetically induced neuronal activation.

Stress during adolescence as a predisposing factor for low back pain in adulthood

Deepika Singhal¹, Rolf-Detlef Treede¹

¹Medical Faculty Mannheim, Department of Neurophysiology, Ludolf-Krehl Str. 13-17, 68161 Mannheim, Germany

Childhood maltreatment has been found to be associated with an increased risk of non-specific low back pain (LBP). However, the relevant molecular mechanisms associated with the initiation or amplification of chronic LBP due to stress in adolescence are largely unknown. We hypothesize that stress in adolescence induces a latent sensitization of the dorsal horn neurons of the low back leading to an increased pain hypersensitivity to an additional mild nociceptive input in adulthood. Here, we investigated if the adversity in young rats augments the mechanical hyperalgesia, alongwith the sex-dependent consequences of stress for the low back pain. A myofascial low back pain animal model already established in lab was used for the study, in which 2 NGF injections are administered at an interval of 5 days and the hyperalgesia in the low back multifidus muscle was checked with the pressure pain threshold of the ipsilateral side. Adolescent female Wistar rats underwent restraint stress for 12 consecutive days and control animals were handled. In adulthood, all rats were injected with two intramuscular injections of NGF/Saline at an interval of 5 days. As a result, latent sensitization was found to be moderately induced ($d=0.58$) due to stress during adolescence as a reduced pressure pain threshold (PPT) was reported after the first saline injection in female rats. However, it induced a higher effect in males ($d=0.87$). Second injection of NGF also showed a moderately decreased ($d=0.54$) PPT of the low back in female rats. Open field test for measuring the anxiety-like behavior showcased moderately ($d=0.6$) established anxiety in stressed rats compared to the control rats. Hence, the sex difference analysis concluded that, stress can moderately induce nociceptive priming in the females, but a larger long-lasting effect was found in males. Therefore, stress during adolescence can be exclaimed as a predisposing factor for the development of the low back pain in adulthood. For the future prospects, molecular mechanisms associated with the mechanical hyperalgesia predisposed by stress during adolescence will be determined.

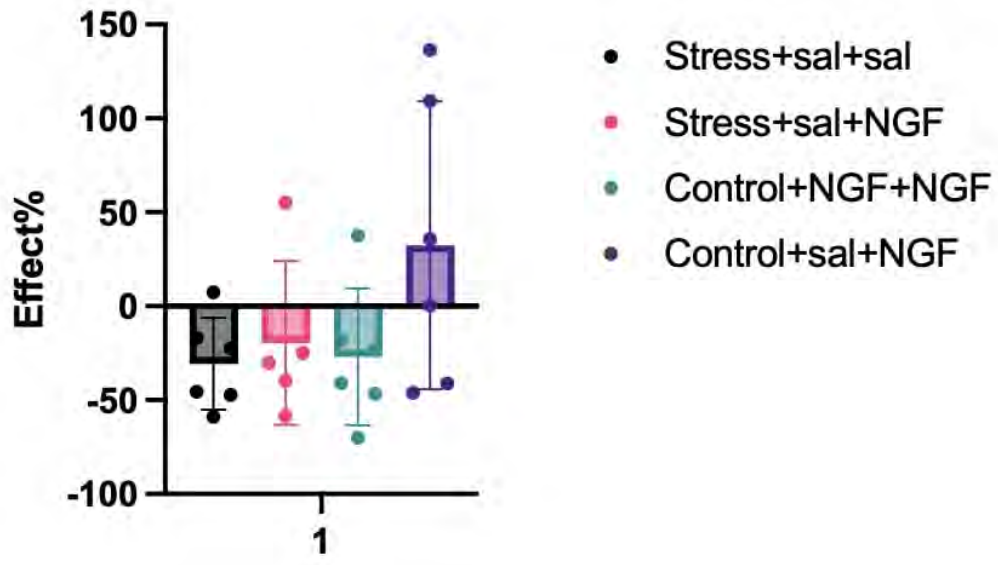

The Effects of Developmental Temperature on Adult Behavior in Flies and Ants

Jana Mach¹, P. Robin Hiesinger¹

¹Division of Neurobiology, Institute for Biology, Freie Universität Berlin, Berlin, Germany

Insects, unlike birds and mammals, do not have an intrinsic mechanism to keep their body temperature constant. In non-social insects, like flies, the temperature during development is entirely dependent on the temperature of the environment. Social insects, on the other hand, care for their offspring throughout their development and are able to regulate the temperature inside developmental chambers to varying extents using different strategies (e.g., active fanning in honey bees, relocation between the nest chambers in different ant species). We have recently characterized the effects of developmental temperature on brain wiring and behavior in *Drosophila melanogaster* (Kiral et al., 2021). Surprisingly, adult behavioral activity is adapted to the temperature at which the fly developed. This effect is specific to overall activity measures, as behavioral parameters related to movement precision are robust to variable developmental temperatures. The underlying cause of the adaptation of adult behavioral activity is currently unknown, but inversely scales with differences in synapse numbers after development at different temperatures. In addition, changes in mitochondrial activity could directly affect activity levels as well as synapse development.

In this work we test both hypotheses and characterize the behavioral and biological consequences of temperature during pupal development in *Drosophila melanogaster* and the clonal raider ant *Ooceraea biroi*, two holometabolous insect species that differ in their reproductive strategies. These experiments are devised to reveal flexible developmental changes of genetically encoded brain development in a variable environment. We propose that evolution has selected for functional, but not identical brains, depending on developmental temperature.

VIP-to-SST circuit motif shows differential short-term plasticity across sensory areas of mouse cortex

Jenifer Rachel¹, Martin Möck¹, Mirko Witte¹, Jochen F Staiger¹

¹Institute of Neuroanatomy, Universitätsmedizin Göttingen (UMG), Kreuzberggring 40, 37077 Göttingen, Germany

Inhibition of GABAergic interneurons has been found critical to fine-tune the excitation-inhibition balance of the cortex. One such connectivity motif is the inhibition of somatostatin (SST)-expressing neurons by vasoactive intestinal polypeptide (VIP)-expressing neurons. While this motif has largely been studied in L2/3 of the cortex, the effects of L2/3 VIPs onto L4 SSTs are yet unknown. Recent evidence has uncovered vast morphological differences between SSTs of L4 in primary somatosensory (S1) and visual (V1) cortices, with S1 cells showing dense L4 axonal arborization characteristic of 'non-Martinotti' (nMC) cells, while V1 'Martinotti' (MC) cells showed a preference to arborize within L1. It is unclear if these morphological differences also manifest functionally in the L2/3 VIP to L4 SST motif.

Therefore, we aimed to study the morpho-electrophysiological connectivity properties of the VIP to SST circuit, and to answer the following questions:

1. Do L2/3 VIPs target L4 SSTs in S1 and V1 cortices?
2. Do L2/3 VIPs exhibit functional differences when targeting L4 nMCs and MCs in S1 and V1 cortices?

We used whole-cell patch clamp in transgenic mouse slices to target VIP and SST cells. Electrophysiological characterization was facilitated using potassium gluconate intracellular solution. A population of SSTs was patched with cesium methylsulfonate solution and held at 0 mV in voltage clamp to study VIP connectivity. Internal solutions contained 2% biocytin for post-hoc morphological recovery.

We identified strong differences in the morphological features of L4 SSTs, wherein cells in S1 fell into the nMC subclass, while in V1 presented with MC-like features. Around 40-45% of tested SST cells were inhibited by VIP cells in both cortices. Parameters like response amplitude, latency and peak time were largely comparable between cortices. However, we observed stark differences in short-term plasticity, which was studied by evoking VIP firing at varying frequencies. During high-frequency stimulation of both motifs, some connections showed short-term facilitation while others showed a stable response. A fraction of VIP-to-nMC, but not VIP-to-MC connections showing short-term depression. We thus provide evidence that VIP cells target morphological subclasses of SST cells differentially, forming cell-type specific inhibitory motifs.

Voluntary passive movement – do flies play?

Wolf Huetteroth¹, Tilman Triphan¹

¹Leipzig University, Genetics, Talstr. 15, 04103 Leipzig, Germany

Play-like behaviour (PLB) is described across the animal kingdom, with a clear emphasis on vertebrate species. Only few studies so far looked at invertebrate PLB, and these cases were mostly restricted to social exchanges.

To address this void, we examined exploratory behaviour in the vinegar fly *Drosophila melanogaster* by presenting single males to an enriched environment with voluntary access to a spinning platform – a carousel. We also analysed the behaviour of blind or proprioceptive impaired flies in this paradigm to determine the respective influence of visual or proprioceptive input. We demonstrate that flies indeed exhibit complex interaction with a moving carousel with repeated and prolonged visits, but also spontaneous avoidance. These interactions were idiosyncratic, but conserved across days in individual animals. Carousel visits of flies with different alleles of the foraging gene (Rover and sitter) deviated from wildtype flies in opposite directions.

We argue that self-exposure to centripetal force represents intentional exafferent stimulation, which may provide an efficient way to improve self-perception and hence motor control. Indeed, male flies that had access to a spinning carousel performed significantly better in a competitive courtship assay than control males, providing evidence for an adaptive value of voluntary passive movement PLB, or intentional exafference.

Poster Topic

T21: Motor Systems

- [T21-1A](#) (Sub-) cortical recordings in zebra finches during vocal interactions
Carlos Manuel Gomez Guzman, Daniela Vallentin
- [T21-2A](#) A detailed characterisation of acoustic motifs in calling songs of the duetting bushcricket *Phaneroptera sparsa*
Charlotte Mudter, Manuela Nowotny, Stefan Schöneich
- [T21-3A](#) Cortical nucleus mMAN contributes to syllable sequencing in adult Bengalese finches (*Lonchura striata domestica*)
Avani Prasad Koparkar, Sooyoon Shin, Timothy L. Warren, Michael Brainard, Lena Veit
- [T21-4A](#) Decoding network architecture and function of the central pattern generator for asynchronous flight reveals a novel mechanism for network desynchronization through electrical synapses
Silvan Hürkey, Stefanie Ryglewski, Nelson Niemeyer, Jan-Hendrik Schleimer, Susanne Schreiber, Carsten Duch
- [T21-5A](#) Decomposition of 3D joint kinematics of forward walking fruit flies, *Drosophila melanogaster*
Moritz Hausteiner, Ansgar Büschges, Till Bockemühl
- [T21-6A](#) Descending control of backward walking - more than just a switch
Stefan Dahlhoff, Aleya Meric, Jan M. Ache
- [T21-7A](#) Effects of deep brain stimulation (DBS) in the entopeduncular nucleus (EPN) in dystonic *dt^{SZ}* hamsters
Anika Lüttig, Stefanie Perl, Maria Paap, Denise Franz, Marco Heerdegen, Rüdiger Köhling, Angelika Richter
- [T21-8A](#) Evidence for distributed temporal representations at the input layer of the cerebellum
Franziska Bender, Berat Semihcan Sermet, Giovanni Diana, Maria Miruna Costreie, Florian Ruckerl, Gael Moneron
- [T21-9A](#) GABA-ergic Neurons of the Stick Insect with a Focus on Intersegmental Connectivity
Matthias Gruhn, Giulia DiCristina, Sherylane Seeliger, Sima Syed-Nejadi, Ansgar Büschges
- [T21-1B](#) Inferring choices from full-body movements during go-before-you-know decision making in freely moving rhesus monkeys

Irene Lacal, Zurna Ahmed, Neda Shahidi, Alexander Gail

[T21-2B](#) Integration of visual and mechanosensory cues by descending neurons controlling backward walking in *Drosophila*

Aleyna M. Meric, Stefan Dahloff, Jan M. Ache

[T21-3B](#) Integration of visual and vibrotactile cues for estimating reach goal direction in humans
Lukas Amann, Virginia Casasnovas, Enrico Ferrea, Alexander Gail

[T21-4B](#) Investigation of motor development in an ion channelopathy model
Grusha Primal Mathias, Dirk Isbrandt, Stephan Marguet, Andrea Merseburg

[T21-5B](#) Optogenetic inhibition reveals causal modulation of parietal motor goal encoding via frontal-to-parietal projections in rhesus monkeys
Hao Guo, Michal Fortuna, Janina Hüer, Stefan Treue, Alexander Gail

[T21-6B](#) Regular physical activity and motor learning induce white matter myelination: a longitudinal, multi-shell diffusion MRI study in rat
Lisa-Marie Goncalves, Nico Lehmann, Patricia Wenk, Marco Taubert, Eike Budinger

[T21-7B](#) Single cell type analysis of wing and haltere premotor circuits in the ventral nerve cord of *Drosophila melanogaster*
Erica Ehrhardt, Samuel C. Whitehead, Shigehiro Namiki, Ryo Minegishi, Igor Siwanowicz, Kai Feng, Hideo Otsuna, FlyLight Project Team, David Stern, Jim Truman, David Shepherd, Michael Dickinson, Kei Ito, Barry J Dickson, Itai Cohen, Wyatt Korff, Gwyneth M Card

[T21-8B](#) Task-dependent modifications of premotor interneuron activity and load processing in an insect leg-muscle control system
Angelina Ruthe, Philipp Rosenbaum, Alkan Özyer, Ansgar Büschges

[T21-1C](#) Temperature responses of stomatogastric neurons in the brush-clawed shore crab, *Hemigrapsus takanoi*.

Wolfgang Stein, Steffen Harzsch

[T21-2C](#) Thalamus drives vocal onsets in the zebra finch song sequence
Felix W. Moll, Devorah Kranz, Ariadna Corredera Asensio, Margot Elmaleh, Lyn A. Ackert-Smith, Michael A. Long

[T21-3C](#) The effect of continuous visual feedback uncertainty on motor adaptation
Virginia Casasnovas, Lukas Amann, Enrico Ferrea, Alexander Gail

[T21-4C](#) The interplay of behavioral rules and feedback during social behavior
Sarath Ravindran Nair, Jan Clemens

- [T21-5C](#) Unraveling *Drosophila* curve walking behavior
Ezequiel Axel Gorostiza, Till Bockemühl, Kei Ito, Ansgar Büschges
- [T21-6C](#) Unraveling the frequency- and layer-specific effects of high-frequency STN stimulation in mice in vivo
Svenja Kreis, Heiko J. Luhmann, Sergiu Groppa, Daniela Mirzac, Muthuraman Muthuraman
- [T21-7C](#) Using a Multi-Network Approach with DeepLabCut to Improve Automatic Pose Estimation
Terrence Michael Wright, Till Bockemühl, Ansgar Büschges
- [T21-8C](#) Using Neuropixels recordings to probe the stability of latent variables of the cortical grasping network in primates
Roberta Nocerino, Jan Churan, Hansjörg Scherberger
- [T21-9C](#) Walking speed affects spatial and temporal variability of leg movements in freely walking *Drosophila melanogaster*
Vincent Godesberg, Ansgar Büschges, Till Bockemühl

(Sub-) cortical recordings in zebra finches during vocal interactions

Carlos Manuel Gomez Guzman¹, Daniela Vallentin²

^{1,2}Max Planck Institute for Biological Intelligence, Vallentin, Eberhard-Gwinner-Straße, 82319 Starnberg, Germany

Vocalizations are often produced within the context of social interactions. However, they might also be produced in absence of external cues. Zebra finches, for instance, are highly vocal and engage in vocal turn-taking when exposed to a social partner, but also produce calls when they are alone. Furthermore, it is not known whether vocal behavior under different contextual constraints is generated by the same or different neural dynamics. Previously, it has been demonstrated that the midbrain area dorsomedial nucleus of the intercollicular complex (DM) drives the production of vocalizations. On the other hand, the cortical premotor nucleus HVC controls the timing of vocal turn taking, which is essential to avoid overlapping call production between individuals. We aim to explore the neural activity in both brain areas while birds call in and outside of a social context by performing high density Neuropixel probe recordings. This technique allowed us to observe the time course of hundreds of neurons from multiple areas of interest simultaneously. We were able to replicate previous results demonstrating that HVC neurons show various characteristic firing patterns when calls are presented (see Norton et al. PNAS 2022). Similarly, we recorded neurons that activated shortly before call onset when a bird interacted with a vocal partner. Additionally, we developed a histology-guided approach that allowed us to reliably and simultaneously insert the Neuropixels probe in the cortical area HVC and the midbrain region DM responsible for call production. With this, we were able to obtain the first midbrain recordings in awake zebra finches listening to conspecific calls. In the future, we aim to characterize the neural activity of HVC and DM during different contexts of call production. Taken together, this work will contribute to a better understanding of midbrain activity in relation to call production and perception, and at the same time address vocal turn-taking with a systems-level approach, thus enabling the possibility of generating models to describe vocal output and its determinants.

A detailed characterisation of acoustic motifs in calling songs of the duetting bushcricket *Phaneroptera sparsa*

Charlotte Mudter¹, Manuela Nowotny¹, Stefan Schöneich¹

¹Friedrich Schiller University Jena, Institute for Zoology and Evolutionary Research, Erbertstr. 1, 07743 Jena, Germany

In many acoustically communicating insects the males produce simple and repetitive sound pulse pattern to attract females of their own species, and the mute females then phonotactically approach the singing male. In the bushcricket subfamily of Phaneropterinae, however, males and females perform acoustic duets for mate finding. Here we conducted and analysed long-term sound recordings of isolated and also acoustically paired males and females of the bushcricket species *Phaneroptera sparsa*. Different elements of the acoustic duets and the mate finding behaviour of this species had been described before by Heller et al. (2021 Europ J Entomol 118: 111-121). They reported that in this species both sexes may move towards each other during mate localisation. In our recordings, most of the isolated males showed a high spontaneous singing activity. We identified and characterised 6 distinct motifs in the male calling song: trills, chirps, single pulses, double pulses, complex pattern (all in the frequency band of about 20-40 kHz), and high-frequency pulses (frequency band: 30-60 kHz). These 6 motifs differed clearly in temporal features and/or sound frequency and were very constant between the individual males. Isolated females, however, did never sing spontaneously during our recordings, but when acoustically paired with a singing male they acoustically responded with a single short sound pulse ('tick'; frequency band: 20-40 kHz) to one specific element of the male song - the complex pattern. The function of the other motifs in the male calling songs are not known yet. After hearing a female response (acoustic reply), the singing males usually changed their acoustic performance by producing much more complex patterns (probably to provoke more female acoustic responses for phonotactic localisation) but also more high-frequency pulses. We hypothesise that, similar to lebinthine crickets (ter Hofstede et al. 2015 Curr Biol 25: 3245-3252), the high-frequency pulses of the male *P. sparsa* may startle the female (sensory exploitation of the startle reflex to provoke substrate vibration by the female) or may even provoke an active vibratory response (true female communication signal) – so that the male could then use the sound and vibration signals to approach the responding female. In further studies we will test if the females actively generate substrate vibration in response to the male's high-frequency pulses. Our detailed analysis and characterisation of the different acoustic motifs in the song of *P. sparsa* are the first step to investigate their exceptionally complex communication system in more detail at a neuroethological level.

Cortical nucleus mMAN contributes to syllable sequencing in adult Bengalese finches (*Lonchura striata domestica*)

Avani Prasad Koparkar¹, Sooyoon Shin², Timothy L. Warren², Michael Brainard², Lena Veit^{1,2}

¹University of Tuebingen

²University of California, San Francisco

Birdsong is a learned vocal behaviour composed of sequences of individual elements called syllables. As most neuroscience research on songbirds focuses on one species with relatively stereotyped songs, the zebra finch, the neuronal mechanisms underlying the formation of songs from variable syllable sequences remain poorly understood.

Here, we test whether cortical nucleus mMAN (*medial magnocellular nucleus of the anterior nidopallium*) contributes to the variable sequencing of adult Bengalese finch (*Lonchura striata domestica*) song. mMAN is part of a basal ganglia-thalamo-cortical loop that projects to motor nucleus HVC. Bengalese finch song contains branch points, where one syllable can be succeeded by multiple following syllables in a probabilistic manner and chunks, where multiple syllables are sung in stereotypical order. After mMAN lesion, sequencing became more random: 1) Transition probabilities at branch points became less predictable (for example ab-c 70% and ab-d 30% became ab-c 60% and ab-d 40%), characterised by an increase in total transition entropy. 2) We observed breaking of previously stereotyped chunks, and introduction of new transitions between syllables. 3) Repeat phrases, where the same syllable is repeated multiple times, increased in length and variability after the lesion. These changes were apparent as soon as singing resumed after the lesion and persisted after the song had stabilised.

mMAN lesions in adult zebra finches have previously been found to have little influence on song production. In contrast, our results suggest that nucleus mMAN contributes to the variable sequencing of Bengalese finch song, and suggests that models of song production may need to include areas upstream of premotor song nucleus HVC for species with more complex song syntax.

Decoding network architecture and function of the central pattern generator for asynchronous flight reveals a novel mechanism for network desynchronization through electrical synapses

Silvan Hürkey¹, Stefanie Ryglewski¹, Nelson Niemeyer², Jan-Hendrik Schleimer²,
Susanne Schreiber², Carsten Duch¹

¹Institute of Developmental Biology and Neurobiology, Hanns-Dieter-Hüsch-Weg 15, Johannes Gutenberg-Universität Mainz

²Institute for Theoretical Biology, Unter den Linden 6, Humboldt-Universität zu Berlin

Asynchronous flight as employed by >600,000 insect species allows particularly high wing beat frequencies of 100-1000 Hz. Physics dictates the need for high wingbeat frequencies for forward propulsion of small insects with low Reynolds numbers. In brief, high frequencies of alternating contractions of wing elevator and depressor muscles are realized by resonating stretch activation. The flight motoneurons (MNs) fire only every ~40th wingbeat to regulate the myoplasmic calcium concentration, which in turn, regulates muscular stretch sensitivity and is linearly proportional to wing power output (Gordon and Dickinson, 2006). Thus, in contrast to vertebrate skeletal muscle, muscle contractions are not regulated by MN activity on the level of single wingbeats, but indirectly and on a much slower time course. In *Drosophila* the firing patterns of the 5 MNs to the 6 fibers of the dorsal longitudinal flight muscle (DLM) is known (Harcombe and Wyman, 1977 & 1978). In brief, during flight all 5 MNs fire at identical frequencies, but not simultaneously, so that the activity of the 5 MNs is splayed-out in time. However, neither the architecture of the underlying central pattern generating network (CPG), nor the functional relevance of these splayed-out motor patterns are known.

By combining electro- and optophysiology with theory, computational modeling, and *Drosophila* genetics we demonstrate that coordinated MN firing is produced by a minimal CPG that does not rely on patterned activity of premotor interneurons. Instead, tonic, unpatterned, cholinergic excitatory input is shaped into splayed-out MN activity by electrical synapses between MNs. The electrical synapses are encoded by ShakingB (ShakB), are bidirectional, and non-rectifying. ShakB-RNAi in the 5 DLM MNs disturbs the splay state and increases firing synchronization, whereas overexpression (oe) of ShakB causes splay state collapse and strong MN firing synchronization. Both theory and computational modeling predict that desynchronization by electrical synapses requires two conditions, weak electrical synapses and a specific excitability profile of the coupled neurons, namely a homoclinic spike onset. The first one is verified *in vivo* by MN firing synchronization in ShakB-oe. We verified also the second theoretical prediction by changing the excitability profiles of the coupled neurons through targeted expression of the delayed rectifier Shab potassium channel. This indeed causes firing synchronization during flight *in vivo*.

We find the same splayed-out firing patterns across individuals and even across different species, indicating high functional relevance. In fact, forced MN firing synchronization through ShakB-oe causes up to 8-fold higher fluctuations in wing beat power than observed in control. By measuring the kinetics of muscle fiber electrical activation and the resulting changes in myoplasmic calcium, we find that splayed-out MN activity minimizes myoplasmic calcium fluctuations across the 6 muscle fibers to stabilize wing power output.

Decomposition of 3D joint kinematics of forward walking fruit flies, *Drosophila melanogaster*

Moritz Haustein¹, Ansgar Büschges¹, Till Bockemühl¹

¹Department of Animal Physiology, Institute of Zoology, University of Cologne, Zùlpicher Straße 47b, 50674 Cologne, Germany

Animals exhibit a rich repertoire of locomotive behaviors. In the context of legged locomotion, i.e. walking, animals can change their heading direction, traverse diverse substrates with different speeds, or can even compensate for the loss of a leg. This adaptability emerges from the fact that biological limbs typically have more joints and/or more degrees of freedom (DOF), i.e. independent directions of motions, than required for any single movement task. This implies that detailed kinematic analyses are required to understand the demands on the underlying motor control system.

Drosophila melanogaster represents an expedient model organism for the investigation of walking. However, its tiny size and relatively fast movements challenge the precise measurement of leg motions. To study 3D joint kinematics, we created a kinematic leg model for *Drosophila* and applied inverse kinematics to replicate leg postures of forward walking fruit flies. For this, flies (n: 12, steps: 241, 256, 273 for front, middle, hind legs) walked on a spherical treadmill and leg movements were recorded with six synchronised high-speed cameras. For 3D reconstruction, 36 leg keypoints (each leg: thorax-coxa joint, ThCx; coxa-trochanter joint, CxTr; trochanter-femur joint, TrFe; femur-tibia joint, FeTi, tibia-tarsus joint, TiTar; tarsus tip, Tar) and five body keypoints were tracked automatically using the DeepLabCut toolbox. We created kinematic chains for all legs based on joint rotational axes and positions extracted from micro-computed tomography (μ CT) data. To determine joint angles, forward kinematics of these leg chains were optimized using a gradient descent algorithm that minimized the distances between the positions of the tracked and model keypoints.

As in other insects, the CxTr and the FeTi were used for levation/depression and flexion/extension in all legs, respectively. In contrast, movements of the ThCx were more complex and required three DOFs for accurate modeling. Fixing of one or two DOFs in the ThCx revealed that individual DOFs were employed differently by the leg pairs during swing and stance phases. Strikingly, the kinematic chains of the front legs required an additional roll DOF in the TrFe which enabled a slight rotation of the femur-tibia plane, while a moveable TrFe was not necessary for modeling the leg postures of the middle and hind legs. Forward stepping of front and hind legs was primarily executed in the anterior-posterior plane, but the leg movements during swing and stance phase were opposite for both leg pairs. The front and hind legs were straightened by promotion of the coxa, depression of the femur, and flexion of the tibia during the swing or stance phase, respectively, while these movements were reversed in the other step phase. In contrast, the middle legs exhibited an idiosyncratic kinematic pattern. Surprisingly, protraction and retraction were not only mediated by movements of the coxa, but also by a prominent rotation of the femur-tibia plane (rotational range of the plane normal, mean \pm SD: 37.6 ± 12.0 degrees). In addition, flexion of the tibia in the middle legs played a lesser role for walking compared to the other leg pairs.

In conclusion, each pair of legs revealed distinct joint kinematics during forward walking. This has implications for the underlying motor control system. Not only do motor commands need to account for this, but also the proprioceptive feedback signals should be shaped by these differences.

Descending control of backward walking - more than just a switch

Stefan Dahlhoff¹, Aleyna Meric¹, Jan M. Ache¹

¹Neurobiology and Genetics, Theodor-Boveri-Institute, Biocenter, Julius-Maximilians-University of Würzburg, Würzburg, Germany

Insects, like other animals, are capable of walking backwards if they encounter an impassable barrier. In *Drosophila*, backward walking is controlled by a small population of four moonwalker descending neurons (MDNs). These neurons integrate visual¹, mechanosensory² and olfactory³ inputs and induce backward walking by altering the dynamics of leg motor circuits in the ventral nerve cord. The combination of knowing a small population of identified descending neurons driving a very robust phenotype, consisting of constant backward walking when activated, presents a unique opportunity to study motor control. Despite the key role of MDNs in the descending control of walking, their activity has not been quantified in behaving animals. For example, it is unclear what the activity of MDNs might look like during walking, forward or backward, and other behavioral states, such as flight. It is therefore unclear how MDNs drive changes in behavior under ethological conditions. We addressed this question by performing in-vivo whole cell patch clamp recordings of individual MDNs in behaving flies. Our experimental setup allows us to analyze walking direction and velocity as well as flight while monitoring MDN activity. In addition, we used an LED arena to deliver visual stimuli to the fly and quantify MDN sensory responses. Our results show that during periods of rest, where no leg movements occur, MDNs are firing at a constant rate. This firing rate is heavily modulated during bouts of leg movement, which occur during walking but also grooming or postural adjustments. Moreover, we find that MDNs are strongly inhibited and visual inputs are suppressed during flight. This inhibition occurs in a stepwise fashion, with a first hyperpolarization upon loss of ground contact and further hyperpolarization at the onset of flight. This hints towards multiple parallel mechanisms underlying flight-dependent MDN inhibition. In summary, our results suggest that MDNs do not simply act as a switch that reverses walking direction when activated, but more like a control knob with an idle position at rest. Depending on the internal state and sensory inputs, this control knob can be finely adjusted. Thus, MDNs could play a crucial role in a circuit maintaining an equilibrium between walking forward, backward and a resting state.

1. Sen, R. et al. Moonwalker Descending Neurons Mediate Visually Evoked Retreat in *Drosophila*. *Curr. Biol.* 27, 766–771 (2017).
2. Sen, R., Wang, K. & Dickson, B. J. TwoLumps Ascending Neurons Mediate Touch-Evoked Reversal of Walking Direction in *Drosophila*. *Curr. Biol.* 29, 4337-4344.e5 (2019).
3. Israel, S., Rozenfeld, E., Weber, D., Huetteroth, W. & Parnas, M. Olfactory stimuli and moonwalker SEZ neurons can drive backward locomotion in *Drosophila*. *Curr. Biol.* 32, 1131-1149.e7 (2022).

Effects of deep brain stimulation (DBS) in the entopeduncular nucleus (EPN) in dystonic *dt^{SZ}* hamsters

Anika Lüttig¹, Stefanie Perl¹, Maria Paap¹, Denise Franz², Marco Heerdegen², Rüdiger Köhling², Angelika Richter¹

¹Institute of Pharmacology, Pharmacy and Toxicology, VMF, University Leipzig, Germany

²Oscar Langendorff Institute of Physiology, University Rostock, Germany

Introduction

DBS of the globus pallidus internus (GPi, entopeduncular nucleus, EPN, in rodents) has become important for the treatment of generalized dystonia. There is evidence that striatal dysfunctions cause a disturbed thalamocortical inhibition via altered neuronal activity in the GPi/EPN. However, the pathophysiology, as well as the mechanisms of DBS, are largely unknown, which hampers the detection of biomarkers for optimization of DBS and add-on therapeutics.

Objectives

In our project of the CRC “Electrically active implants” we aim to elucidate mechanisms of DBS in animal models of dystonia. We recently found that short-term (3 h) EPN-DBS with 130 Hz (50 μ A, 60 μ s) improves paroxysmal dystonia in the *dt^{SZ}* mutant hamster and reduces spontaneous excitatory cortico-striatal activity in brain slices of this model, indicating fast effects in synaptic plasticity. In the present study, we, therefore, examined whether short-term DBS leads to changes of c-Fos, an immunohistochemical marker of neuronal activity, and of brevicin, a perineuronal net protein involved in the regulation of synaptic plasticity, in EPN-related network regions.

Materials & Methods

For immunohistochemistry, we used brains of stimulated *dt^{SZ}* hamsters, in which DBS had improved dystonia, as well as sham-stimulated and naïve animals and performed cell counting and fluorescence intensity measurements within the basal ganglia (BG) network. Therefore, we performed double labeling of c-Fos with GAD67 and with parvalbumin (PV), respectively and for the investigation of the perineuronal net component, we performed double labeling of brevicin with PV in the same *dt^{SZ}* hamsters and equally treated control animals.

Results

After DBS vs. sham, c-Fos⁺ around the electrode was increased. Unexpectedly, c-Fos⁺ cells were decreased in deep cerebellar nuclei (DCN) after DBS, but no changes became evident within the whole EPN, habenula, ventromedial thalamus, cortex and striatum. Cell counting of c-Fos activated GAD67⁺, as well as activated PV⁺ cells, showed no differences between the groups in motor cortex and striatum. Brevican comparison of *dt^{SZ}* and control hamsters revealed interesting differences within the BG-thalamocortical circuit, but no changes after DBS became evident.

Conclusion

With regard to recent electrophysiological data, we expected c-Fos changes especially in cortical GABAergic

neurons after DBS in dt^{SZ} hamsters. The lack of changes within the BG network could be related to the short duration of stimulation or the time interval between stimulation and c-Fos staining. The changes in brevican in naïve animals could point to a developmental disruption of PN which may contribute to the presumed disinhibition of PV⁺ neurons and abnormal plasticity within the BG circuit. However, it remains unclear whether the findings represent a cause of dystonia or the consequences of other changes. Ongoing long-term EPN stimulations, now feasible by a new fully implantable stimulator (STELLA), probably lead to more pronounced effects within the network and will be useful to verify the DCN effects.

Funded by the Deutsche Forschungsgemeinschaft (DFG, German Research Foundation) - SFB 1270/1,2 – 299150580

Evidence for distributed temporal representations at the input layer of the cerebellum

Franziska Bender¹, Berat Semihcan Sermet¹, Giovanni Diana¹, Maria Miruna Costreie¹, Florian Ruckerl¹, Gael Moneron¹

¹Synapse and Circuit Dynamics, Département de Neurosciences, Institut Pasteur, Paris, France

The cerebellum processes contextual information with an internal model (Wolpert et al, 1998) and generates delayed temporal associations between conditioned sensory and unconditioned stimuli (Medina et al, 2000) to fine-tune motor and cognitive behaviors. Each granule cell (GC) receives diverse sensory information from mossy fibers (MFs) to represent rich contextual information within the population (Chabrol et al, 2015; Ishikawa et al, 2015). Information from multiple modalities is integrated, expanded and recoded to maximize the number of sensory patterns that can be detected and finally control body muscles (Marr, 1969; Albus, 1971). The GC layer is thought to generate a diverse temporal representation that enables learning temporally precise behaviors (Medina et al. 2000). A network model from the lab suggests that input specific diversity of MF-GC synaptic dynamics are sufficient to generate diverse GC firing patterns that act as a temporal basis for cerebellar learning. We expressed fast GCaMP8f in GCs and measured the diversity of sensory responses in vivo using two-photon laser-scanning microscopy. We observed a temporal distribution of calcium response times and durations across the population, which could not be accounted for by trial to trial variability and was consistent with a diverse temporal representation. By sparse expression of glutamate reporter SF-iGluSnfr (Marvin et al., 2017) we simultaneously recorded from all MF-GC synapses of a given GC. Specific MF-GC synapses responded to selective sensory stimuli or combinations and with differences in firing frequencies and delays. We compared temporal representations of whisker stimulation by MF activity, MF-GC synapse glutamate release and GC activity. Our data are consistent with a transformation due to the diversity of STP and support theoretical work.

GABA-ergic Neurons of the Stick Insect with a Focus on Intersegmental Connectivity

Matthias Gruhn¹, Giulia DiCristina¹, Sherylane Seeliger¹, Sima Syed-Nejadi¹, Ansgar Büschges¹

¹University of Cologne, Inst.f.Zoology/Animal Physiology, Zùlpicher Straße 47 b, 50674 Koeln, Germany

Coordinated walking movements need constant adaptation to the requirements of the environment. In the stick insect *Carausius morosus*, coordinated walking is the result of descending control from the brain, activity of local pattern generating networks, local sensory feedback from the limbs and intersegmental information flow (e.g. Mantziaris et al. 2017, Bidaye et al. 2018, Haberkorn et al. 2021).

One major factor that is known to shape the activity of these different motor behavior-generating components is inhibition (e.g. Büschges & Schmidt 2015, Gebehart et al. 2022), yet the sources of this local and intersegmental inhibition are still only partially known. In addition, at present, only little information exists on numbers and transmitter content of intersegmentally projecting neurons between the brain and the thoracic ganglia as well as between the thoracic ganglia, which could be responsible for conveying modulating or coordinating influences (eg. Mentel et al. 2007, Stolz et al.2019).

We therefore systematically retrogradely labeled the connectives of the stick insect ventral nerve cord and combined the staining with anti- γ -aminobutyric acid (GABA) immunocytochemistry to 1) identify numbers and location of putatively inhibitory GABA-positive neurons, and 2) number and location of intersegmentally projecting inhibitory neurons within this population in the stick insect nervous system.

We found that that the cerebral ganglion (CG) contains approximately 1400 GABA-IR neurons plus another approximately 1000 GABA-IR neurons in the optic lobes. The gnathal or subesophageal ganglion (GG) contains approximately 600 GABA-IR neurons, and the pro- meso and metathoracic ganglia (ProG, MesoG, MetaG) approx. 500, 560 and 760 GABA-IR neurons, resp.

Of the descending up to 320 neurons from the CG, so far only 26 neurons in the CG were found GABA-positive, while of the up to 440 neurons descending from the GG towards the thoracic ganglia, up to 160 were GABA-positive. From the Pro-, Meso-, and Metathoracic ganglia, up to 310, 340, and 300 descend posteriorly, of which up to 140 descending GABA-positive neurons were found in the ProG, up to 92 in the MesoG, and 54 GABA-positive neurons were found in the MetaG. From the 510, 326, and 580 neurons ascending anteriorly from the ProG, MesoG and MetaG, resp., up to 84 ascending GABA-positive neurons were found in the ProG, up to 166 in the MesoG, and up to 154 ascending GABA-positive neurons in the MetaG.

The localization of putative local and intersegmental inhibitory neurons will give us an important tool to characterize inhibitory network components in the stick insect walking system.

This work was supported by DFG grant Bu857/15.

Inferring choices from full-body movements during go-before-you-know decision making in freely moving rhesus monkeys

Irene Lacal¹, Zurna Ahmed^{1,2}, Neda Shahidi^{1,3}, Alexander Gail^{1,2,3,4}

¹Sensorimotor Group, German Primate Center, Goettingen, Germany

²Faculty for Biology and Psychology, University of Goettingen, Germany

³Leibniz ScienceCampus Primate Cognition, Goettingen, Germany

⁴Bernstein Center for Computational Neuroscience Goettingen, Germany

Neurophysiological experiments conducted with chair-seated animals have extensively demonstrated that action goals are dynamically represented in primate sensorimotor cortex during movement planning and execution. To which extent established concepts gained from lab studies generalize to more complex, ecologically-relevant contexts remains unknown. We address this question by studying goal-directed, full-body movements in a behavioral paradigm that requires the experimental animal to decide while acting and that can allow us to investigate the neural basis of decision making in freely moving monkeys.

Two rhesus macaques were trained to perform a walk-and-reach task in a 4.6 m (W) x 2.5 m (D) x 2.6 m (H) enclosure (Exploration Room) with two synchronized touchscreen-based kiosk systems (XBIs) [1] serving as potential targets on a short side of the room. To start a trial, the monkey had to acquire a centered position at the opposite side of the room. Once the touchscreens turned white, the animal was allowed to walk towards the offered targets within a pre-defined time window. During this movement epoch, a change in color of the two screens revealed the reward associated to each target (blue = low, red = high) at varying stimulus-onset asynchrony (SOA). Animal movements were registered by six FLIR chameleon cameras, safely mounted inside the experimental room by mean of a custom-developed, adjustable, animal-proof chassis (ExplorEye). The monkeys' full-body postures were tracked offline in 2D using DeepLabCut [2] and reconstructed in the 3D space using Pose3D [3].

The animals showed motivation to engage in the task, as they spent on average 82-89% of the session duration performing the required walk-and-reach movements with a success rate above 90%. Moreover, within the first 30 sessions, both monkeys transitioned from a directionally-biased guessing behavior to a predominant reward-based choice strategy. The analysis of their velocity profiles showed that longer SOAs correlate with shorter peak velocity latency and longer movement time. To identify the point of commitment to the chosen option, we applied an adapted version of the Cone method [4], a tool for single trial readout of target commitment from 3D trajectories. A correlation between the SOA and the time of commitment to the chosen option was found for both monkeys.

Our results support three conclusions: (i) monkeys can learn to engage in experimentally controlled, goal-directed and unconstrained walk-and-reach movements in a trial-wise fashion within a large environment; (ii) full-body movement kinematics depend on the timing of environmental salient information and can be extracted from video-based markerless motion capture; (iii) the moment of commitment to a target can be quantified with good precision in single walking trajectories. These conclusions support the feasibility of the adopted paradigm for trial-wise neurophysiological testing of choice behavior in freely moving macaques.

1. Calapai, A. et al., Behavior research methods, 49(1), 35-45 (2017).

2. Nath, T. et al., Nature protocols, 14(7), 2152-2176 (2019).

3. Sheshadri, S., et al., Journal of Open Source Software, 5(45), 1849 (2020).

4. Ulbrich, P., & Gail, A., Behavior Research Methods, 1-17 (2021).

Integration of visual and mechanosensory cues by descending neurons controlling backward walking in *Drosophila*

Aleyna M. Meric¹, Stefan Dahlhoff¹, Jan M. Ache¹

¹Neurobiology and Genetics, Theodor-Boveri-Institute, Biocenter, Julius-Maximilians-University of Würzburg, Würzburg, Germany

Animals constantly adjust their behavior to ever-changing environmental conditions. Sensory information like vision, olfaction, and touch, converges in the brain, and through descending neurons (DNs) is relayed to motor circuits in the ventral nerve cord to elicit adaptive behavioral responses. Some specified yet flexible behaviors, like walking, are modulated by specific descending command neurons that are sufficient to elicit and necessary for the full display of that behavior. One example of this is the Moonwalker descending neurons (MDNs) in the *Drosophila melanogaster* nervous system which can switch the walking direction from forward to backward. MDNs form a population of four DNs, two in each hemisphere. Given their small number and key role in modulating locomotion, MDNs provide a great model for exploring how behavioral changes are elicited by descending command-like neurons in response to sensory cues. In insects, backward walking can be elicited by mechanosensory cues, for example, antennal touch, visual cues, such as an approaching object, and aversive olfactory stimuli.

Here, we set out to investigate the responses of individual neurons in the MDN population to multimodal sensory stimulation. To study how MDNs integrate visual and mechanosensory cues, we performed *in vivo* whole-cell patch-clamp recordings in tethered, non-behaving *Drosophila* and quantified the activity of individual MDNs during visual and mechanosensory stimulation. Visual stimulation was performed by presenting wide-field visual motion stimuli and moving objects on an LED Arena. For mechanosensory stimulation, frontal air puffs were delivered to the body of the flies.

Our preliminary results reveal that MDNs exhibit differential responses depending on the visual stimulus shown. Moreover, individual neurons in the MDN population differ in their responses to visual stimuli. These findings suggest that the two MDNs in each hemisphere are differentially tuned to sensory inputs. Ablation experiments revealed that MDN responses to mechanosensory stimuli were mediated by the antennae, wings, and halteres. These mechanosensory responses, like the visual ones, also differed between individual MDNs. In summary, our results suggest that the sensory tuning of the two MDNs on each side of the brain is different. Thus, from a sensory perspective, the four MDNs form a heterogeneous population. Ultimately, our findings can deliver insights about the role of DN populations in modulating adaptive locomotion via the integration of multimodal sensory cues.

Integration of visual and vibrotactile cues for estimating reach goal direction in humans

Lukas Amann^{1,2}, Virginia Casasnovas^{1,2}, Enrico Ferrea^{1,3}, Alexander Gail^{1,2,4,5}

¹German Primate Center, Sensorimotor Group, Göttingen, Germany

²Faculty of Biology and Psychology, Georg-August University, Göttingen, Germany

³Institute for Neuromodulation and Neurotechnology, University Hospital and University of Tuebingen, Tuebingen, Germany

⁴Bernstein Center of Computational Neuroscience, Göttingen, Germany

⁵Leibniz ScienceCampus Primate Cognition, Göttingen, Germany

When reaching towards objects, information of multiple senses is needed to perform appropriate movements and to control different kinematic parameters. Visual feedback provides position information of the hand and potential reach goals. In addition, the somatosensory system delivers data about muscle and joint configuration which is called proprioception. Understanding the underlying process of multisensory integration in the context of movements is relevant for the control of neuroprostheses, where often only visual input provides feedback about the position of the artificial effector.

To investigate the integration of visual and somatosensory inputs during movement planning and execution, both types of information need to be experimentally controlled. Since proprioception is difficult to control, a different way of providing somatosensory input is needed.

Here we tested a non-invasive way of delivering information about the location of reach goals using vibrating motors attached to the moving arm of subjects. To test the suitability of this type of sensory stimulation, human subjects performed a memory-guided center-out reach task with a haptic manipulandum in a 2D workspace without seeing their own hand but a cursor representation of their hand position instead. Target direction was cued either visually, using vibrotactile stimulation or a combination of both types of sensory input. Before starting with the main experiment, subjects were familiarized with vibrotactile stimulation during a training session. Multisensory integration becomes especially important in situations where one sensory modality is of limited reliability. Here, we systematically varied visual target uncertainty to encourage visuotactile integration.

Preliminary data suggests that subjects' initial reach angle closely matched the target angle instructed using vibrotactile cues. Furthermore, high visual target uncertainty led to large initial reach errors, but when provided with additional congruent vibrotactile stimulation, initial reach error was reduced.

Based on these findings, we conclude that human subjects are able to interpret vibrotactile cues and combine them with visual information, especially when the latter is unreliable.

Investigation of motor development in an ion channelopathy model

Grusha Primal Mathias¹, Dirk Isbrandt¹, Stephan Marguet¹, Andrea Merseburg¹

¹DZNE Bonn & University of Cologne, Kerperner str. 62, 50937 Köln, Germany

Motor action is essential for patterning developing brain circuits and learning in the physical world. Developing brains, however, are more prone to insults that can lead to neurodevelopmental disorders, such as attention-deficit hyperactivity disorder (ADHD), autism spectrum disorder (ASD), and developmental epileptic encephalopathies (DEEs). Although diverse, many of these disorders share common comorbidities, especially motor dysfunctions. We hypothesized that in *de novo* ion channel mutation causing DEEs, abnormal network excitability in the cortico-basal ganglia-thalamic loops during brain development results in observed motor deficits. To study the normal and altered developmental trajectory of motor control, we perform *in vivo* acute silicon probe depth recordings from the primary somatosensory cortex and the dorsolateral striatum in mice between the ages of postnatal day (P) 5 and 42. We use the Mobile HomeCage setup (Neurotar) for animals >P15, allowing us to record from head-fixed behaving animal at various timepoints. In order to establish the method and identify the direct vs. indirect pathway spiny projection neurons (dSPNs & iSPNs respectively), we use an Adenosine 2A receptor (Adora-2a) promoter-driven Designer Receptors Exclusively Activated by Designer Drugs (DREADDs) mouse line, described by Farrell et al., 2013, to chemogenetically activate only the iSPNs. After spike sorting with Kilosort3, we are able to identify and differentiate the SPNs and interneurons, mainly fast-spiking (FSI) and tonically active neurons (TANs). Furthermore, we cross this DREADD line with a mouse line deficient in hyperpolarization-activated nucleotide-gated cation channel (HCN)/h-current activity in forebrain projection neurons to understand the extent to which these ion channels play a role in the development of motor control. Adult mice of this line show neurodevelopmental phenotypes, such as locomotor hyperactivity and stereotypies, when h-current deficiency was present during the first three postnatal weeks. **Future directions:** We seek to characterize the local field potentials and unit activities to identify and therapeutically target abnormal network excitability during vulnerable time windows of motor development to ameliorate or prevent the neurodevelopmental phenotype.

Optogenetic inhibition reveals causal modulation of parietal motor goal encoding via frontal-to-parietal projections in rhesus monkeys

Hao Guo¹, Michal Fortuna^{1,3}, Janina Hürer^{2,4,8}, Stefan Treue^{2,5,6,7}, Alexander Gail^{1,5,6,7}

¹Sensorimotor Group, German Primate Center, Goettingen, Germany

²Cognitive Neuroscience Laboratory, German Primate Center, Goettingen, Germany

³Allen Institute for Brain Science, Seattle, WA, USA

⁴Ernst Strüngmann Institute for Neuroscience in Cooperation with Max Planck Society, Frankfurt, Germany

⁵Faculty for Biology and Psychology, University of Goettingen, Germany

⁶Leibniz ScienceCampus Primate Cognition, Goettingen, Germany

⁷Bernstein Center for Computational Neuroscience Goettingen, Germany

⁸Laboratoire de Neurosciences Cognitive et Computationnelles, Ecole Normale Supérieure, INSERM, PSL University, Paris, France

Context-dependent visuomotor transformations are associated with the frontoparietal network in the cerebral cortex of primates. It has been hypothesized that the dorsal premotor cortex (PMd) and the parietal reach region (PRR) coordinate their activities via reciprocal connections to select motor goals. Context-dependent visuomotor mapping can be probed with a center-out anti-reach task, requiring subjects to respond to a spatial cue with an opposite-side reach movement. The slower spatial remapping of a visual cue onto an incongruent motor goal in anti-reaches putatively demands higher levels of cognitive control than the congruent mapping in pro-reaches. Latency analysis of neuronal spiking activity in previous studies had shown that PMd leads PRR in terms of encoding motor goals particularly in anti- but not pro-reaches. Yet, if and how the activity in PMd causally influences neural dynamics in PRR during motor goal selection is still unclear. Here, we tested the hypothesis that PMd causally impacts PRR spatial encoding of motor goals and that this impact is stronger during incongruent visuomotor mapping compared to congruent mapping.

To address this question, neural dynamics of PRR neurons were studied in combination with pathway-selective (PMd to PRR) optogenetic silencing of PMd axons projecting to PRR, while monkeys performed a memory-guided, center-out, anti-reach task. To this aim, neurons in the PMd area of two rhesus monkeys were transduced with the inhibitory opsin eArchT3.0 delivered in an AAV5 vector, and driven by the CamKII α -promoter (AAV2/5-CamKII α -eArchT3.0-eYFP). While the monkeys performed the task, continuous laser stimulation (532 nm λ , 330 ms pulse duration) was applied during the presentation of the visual cues that instructed the spatial target and the pro-anti task rule prior to a delay period for planning the movement. Stimulation trials were randomly interleaved with no-stimulation trials, and single-unit microelectrode recordings were performed simultaneously in the laser-stimulated neuropil, either in the transfected PMd or in PRR.

Local laser stimulation in PMd resulted in reliable silencing of PMd neural activity, proving evidence for a functional expression of inhibitory opsin in the transfected PMd neurons. Laser stimulation of the PMd axons projecting to PRR decreased the amplitude of local field potential in PRR and modulated neural responses in the nearby neurons, providing evidence that inhibition of presynaptic activity from PMd was effective in modulating postsynaptic neural activities. Importantly, modulation effects were not limited to the laser

stimulation period but also extended to the movement planning period which followed the laser stimulation. The causal influence of PMd projection silencing on PRR was context-dependent, in that motor goal encoding at the PRR population level was delayed exclusively during anti-reach trials. This result was demonstrated by both population-level directional decoding and time-resolved analysis of average directional selectivity in PRR.

Our results support the hypothesis that dynamic reorganization in PRR, as it is selectively needed for spatial remapping in anti- but not pro-reach trials, depends on the functional and direct input from PMd. Our findings strengthen the view that rule-based, goal-directed reaching partly builds on frontal-to-parietal causal modulation in the primate sensorimotor system.

Regular physical activity and motor learning induce white matter myelination: a longitudinal, multi-shell diffusion MRI study in rat

Lisa-Marie Goncalves¹, Nico Lehmann², Patricia Wenk¹, Marco Taubert^{2,3}, Eike Budinger^{1,3}

¹Leibniz Institute for Neurobiology, CNI, Brenneckestraße 6, 39118 Magdeburg, Germany

²Otto-von-Guericke University Magdeburg, Faculty of Human Sciences, Department of Sport Science, Zschokkestr. 32, D-39104, Magdeburg, Germany

³Center for Behavioural Brain Sciences, Universitätsplatz 2, D-39106 Magdeburg, Germany

Introduction

Physical activity is supposed to improve brain health and plasticity; yet clinical application of training interventions requires a better characterization of the underlying microstructural processes, like activity-dependent myelination [1]. Multi-shell diffusion-based MRI measures brain tissue parameters indicative of myelination non-invasively across the brain. We examined the effects of running wheel (RW) exercise and rotarod (RR) training on white matter (WM) tracts across the rat brain using diffusion tensor imaging (DTI) and neurite orientation dispersion and density imaging (NODDI) [2].

Methods

Twenty-eight male Wistar rats were assigned to an Exercise- (EG) and Control-Group (CG). The EG underwent RW exercise, followed by RR training, the CG underwent only RR training. In vivo brain images were acquired at a Bruker 94/20 system at three time points. An optimized SE-EPI protocol was used for the DTI experiment (TR = 3000 ms, TE = 23.10 ms, with four b-values: 0, 1000, 1500, 2000 s/mm²; 64 vectors) as well as a single-shot gradient-echo-EPI scan for a resting-state BOLD-fMRI (TR = 1000 ms, TE = 15 ms, resolution = 0.400 mm, 720 repetitions, 34 slices, 1 average). Averaged values of fractional anisotropy (FA), mean diffusivity (MD), orientation dispersion (OD), and intra-cellular volume fraction (ICVF) were extracted within whole-brain WM and several other atlas ROIs using FSL routines. For individual as well as group comparisons, Mann-Whitney-U and Wilcoxon-tests were applied.

Results/Discussion

Subsequent to the descriptive statistics of behavioral data for all animals (n=28), a t-test for adjusting the differences in RR performance between EG and CG was conducted, revealing a significantly higher mean latency in rotarod for animals who underwent RW exercise before RR training ($p=0.04$; $A=0.05$). Regarding imaging data, our results (n=11) revealed several changes in most diffusion parameters specific for the three training conditions (only RW, only RR, both RW and RR). Generally, for total WM as well as for several individual WM structures FA and ICVF increased, while MD and OD decreased. The combination of exercise and training showed the most notable effects on an individual comparison particularly in FA with significant increases in total WM (2%) as well as in various ROIs with the strongest increases in hippocampal fibers (7%) and the corpus callosum (6%). For RW exercise and RR training alone, these two ROIs showed the strongest percentual increase as well, although only significant for RW exercise with an increase of about

6% in hippocampal fibers and about 4% in the corpus callosum. Spearman-correlations between WM changes and performance were computed, indicating a relationship between WM changes and RR performance for animals that underwent both RW exercise and RR training ($r = 0.987$, $p = 0.001$). Currently, more imaging data are analyzed to increase the sample size, as well as the evaluation of the rs-fMRI data.

Conclusions

We provide preliminary evidence that the combination of physical exercise and rotarod training induces significant changes in WM brain structures. Our results are indicative of adaptive myelination and increased fiber density, further analyses on rs-fMRI data might give insights into exercise- and training-induced functional connectivity.

Acknowledgement

This study was supported by the CRC 1436.

References

- 1] Lehmann N, Tolentino-Castro JW, Kaminski E, Ragert P, Villringer A, Taubert M. Interindividual differences in gray and white matter properties are associated with early complex motor skill acquisition. *Hum Brain Mapp.* 40(15):4316-4330.
- [2] Lehmann N, Aye N, Kaufmann J, Heinze HJ, Düzel E, Ziegler G, Taubert M. Longitudinal Reproducibility of Neurite Orientation Dispersion and Density Imaging (NODDI) Derived Metrics in the White Matter. *Neuroscience* 457:165-185.

Single cell type analysis of wing and haltere premotor circuits in the ventral nerve cord of *Drosophila melanogaster*

Erica Ehrhardt¹, Samuel C. Whitehead², Shigehiro Namiki³, Ryo Minegishi³, Igor Siwanowicz³, Kai Feng⁴, Hideo Otsuna³, FlyLight Project Team³, David Stern³, Jim Truman^{3,5}, David Shepherd⁶, Michael Dickinson^{3,7}, Kei Ito^{1,3}, Barry J Dickson³, Itai Cohen², Wyatt Korff³, Gwyneth M Card³

¹University of Cologne, Institute of Zoology, Zùlpicher Str 47b , 50674 Cologne, Germany

²Physics Department, Cornell University, 271 Clark Hall, Ithaca, New York 14853, USA

³Janelia Research Campus, Howard Hughes Medical Institute, 19700 Helix Dr, Ashburn, Virginia, 20147, USA

⁴Queensland Brain Institute, University of Queensland, 79 Upland Rd, Brisbane, QLD, 4072, Australia

⁵Department of Biology, University of Washington, Seattle, Washington 98195, USA

⁶School of Natural Sciences, Bangor University, Bangor LL57 2UW, Bangor, UK

⁷California Institute of Technology, 1200 E California Blvd, Pasadena, California 91125, USA

The precise control of motor behavior is essential for survival and reproduction. Fruit flies adjust their wing and haltere movements dynamically to stabilize their flight or to perform rapid aerial maneuvers. Male flies produce courtship song by vibrating a single wing. Little is known about how premotor circuits in the nerve cord generate such distinct patterns of motor behavior. Even though the muscles as well as the motoneurons (MNs) innervating to these muscles have been known, the detailed anatomical features as well as the functions of these neurons are not well understood. Nerve cord interneurons that should lie upstream of these motoneurons have hardly been investigated.

To create a toolkit for investigating the organization of premotor circuits, we used a combinatorial genetic technique, split-GAL4 intersections, to create 195 sparse driver lines targeting approximately 200 individual cell types innervating the neck, wing and haltere neuropils and intermediate tectulum of the adult *Drosophila* ventral nerve cord. Using Multi-color flip out (MCFO) technique to induce reporter gene expression stochastically in each driver line, we visualized single neurons and analyzed their morphology.

Our driver lines target all the 12 wing power MNs, 16 out of the 18 known wing steering MNs, 5 out of 8 known haltere MNs, 4 out of the 6 mesothoracic ventral unpaired median (VUM) neurons, and over 150 VNC interneurons. The power MNs innervating the dorsal longitudinal muscle (DLM) have already well characterized, but for the first time we have precisely described the morphology of all the power MNs innervating the dorsal ventral muscles (DVM). Whereas these power muscle MNs mainly innervate within the wing neuropil, wing steering muscle MNs often also innervate the neck and haltere neuropils, where they may receive information for stabilizing flight or steering. Likewise, we found that haltere MNs innervate either only within the haltere neuropil or extend into the wing and neck neuropils.

The VNC interneurons were characterized with the developmental origins based on their cell body fiber trajectories, and input and output synaptic sites based on their characteristic morphology. They were further classified based on their primary target neuropils, laterality, and inter- or intra-segmental projection patterns. Our library of driver lines will enable experiments to dissect the premotor circuits that control wing-related

motor behavior of the fruit flies such as flight and courtship. Detailed anatomical information within the VNC will enable precise matching of identified neurons with the neurons segmented from the electron microscopy data.

Task-dependent modifications of premotor interneuron activity and load processing in an insect leg-muscle control system

Angelina Ruthe¹, Philipp Rosenbaum¹, Alkan Özyer¹, Ansgar Büschges¹

¹University of Cologne, Institute of Zoology, Zùlpicher Str. 47b, 50674 Cologne, Germany

Animals can rapidly change their walking direction when needed. While this sounds simple at first, it requires a number of modifications within the locomotor system. From previous work on the stick insect walking system, it is known that the activity of most antagonistic muscle pairs remains the same during forward and backward walking. Only the thorax-coxa (ThC) joint motor neurons (MNs), i.e. retractor coxae (RetCx) and protractor (ProCx), reverse their activity pattern in such a way that RetCx is active during stance phase when the animal walks forward and during swing phase when the animal walks backward (and vice versa for ProCx; Rosenbaum et al. 2010). In addition, it has been shown that the effect of load feedback from leg load sensors (campaniform sensilla) on ThC MNs changes along with a change of the walking direction so that increasing load promotes activity of the stance MN pool, i.e. RetCx during forward and ProCx during backward stepping (Akay et al. 2007). However, it is not yet known, how the segmental neural networks generate the switch in ThC MN activity and the change in influence of load feedback when changing the stepping direction.

Here, we used the semi-intact single-leg preparation, in which we recorded MN activity extracellularly and premotor interneuron activity intracellularly, while the middle leg performed stepping movements on a treadmill. In this experimental condition, tactile stimulation of either the abdomen or the head elicits “fictive” forward or backward motor activity (Rosenbaum et al. 2015).

So far, our data show that all recorded premotor interneurons were modulated during both stepping directions, suggesting that the same premotor network controls motor activity in both conditions. Currently, we are specifically focusing on the premotor interneurons of the ThC motor neurons and their input and output onto motor neurons in both walking directions to understand where task-dependent changes are implemented within the premotor network. Furthermore, we are working on an experimental approach that allows to integrate CS stimulation into the aforementioned single-leg preparation to further analyze the processing of load feedback during both walking directions.

The study was supported by DFG grants Bu857 and 233886668/GRK1960.

Temperature responses of stomatogastric neurons in the brush-clawed shore crab, *Hemigrapsus takanoi*.

Wolfgang Stein¹, Steffen Harzsch²

¹Illinois State University, School of Biological Sciences, Campus Box 4120, 61790 Normal, USA

²University of Greifswald, Cytology and Evolutionary Biology, Soldmannstr. 23, 17489 Greifswald, Germany

The intertidal brush-clawed shore crab, *Hemigrapsus takanoi*, is native to the temperate waters of Japan. It has recently seen a dramatic invasive expansion into colder European waters, but the reasons for this expansion remain unclear. Here, we investigate the temperature range at which the nervous system of *H. takanoi* remains functional as a possible aspect of this species' invasive success. Since the body temperature of intertidal invertebrates closely follows the rapidly changing temperatures in this habitat, neurons are predicted to function over a wide temperature range to ensure survival and facilitate the species' range expansion.

We analyzed in vitro temperature responses of the pyloric central pattern generating neurons in the stomatogastric ganglion. The pyloric rhythm serves a vital function in digestion. Like in other decapod species, it was continuously active with a triphasic pattern and well-maintained phase relationships (N>10). However, in contrast to other crabs, pyloric rhythm frequency increased only moderately with temperature, reaching a maximum of <1 Hz below 20°C. Unexpectedly, pyloric phase relationships changed, with warmer temperatures increasing the duty cycle of the pyloric PY neurons.

The pyloric rhythm was very cold-resistant. First action potentials failed at 2.7±0.4°C (N=8). Rhythmic activity stopped at 0.8±0.3°C (N=7). At high temperature, individual action potentials or bursts failed at 30.5±0.9°C (N=10). The rhythm crashed at 31.7±0.9°C (N=10) when neurons started to fire in unpredictable ways. A return to room temperature restored rhythmic activity in all cases.

Thus, *H. takanoi* neurons remain functional over a range of almost 30°C. We are currently testing the effects of long-term changes in habitat temperature on neuronal activity.

Thalamus drives vocal onsets in the zebra finch song sequence

Felix W. Moll^{1,2}, Devorah Kranz², Ariadna Corredera Asensio², Margot Elmaleh², Lyn A. Ackert-Smith², Michael A. Long²

¹University of Tuebingen, Institute of Neurobiology, Auf der Morgenstelle 28, 72076 Tuebingen, Germany

²NYU Neurosci., NYU Sch. of Med., New York, NY

While motor cortical circuits contain information related to specific movement parameters, long-range inputs also play a critical role in action execution. Thalamic projections can shape premotor activity and have been suggested to mediate the selection of short, stereotyped actions comprising more complex behaviors. However, the mechanisms by which the thalamus interacts with motor cortical circuits to execute such movement sequences remain unknown. Here we find that thalamic drive engages a specific subpopulation of premotor neurons within the zebra finch song nucleus HVC (proper name) and that these inputs are critical for the progression between vocal motor elements (i.e., 'syllables'). In vivo 2-photon imaging of thalamic axons in HVC revealed consistent song-related activity, and online perturbations of thalamic function caused song to be truncated at syllable boundaries. We used thalamic stimulation to identify a sparse set of thalamically-driven neurons within HVC, representing ~15% of the premotor neurons within that network. Surprisingly, this population of putative thalamorecipient neurons is robustly active immediately preceding syllable onset. Through selective targeting of these 'starter cells', thalamic input may be initiating individual song components. These findings highlight the motor thalamus as a director of cortical dynamics in the context of an ethologically-relevant behavioral sequence.

The effect of continuous visual feedback uncertainty on motor adaptation

Virginia Casasnovas^{1,2}, Lukas Amann^{1,2}, Enrico Ferrea^{1,3}, Alexander Gail^{1,2,4,5}

¹Sensorimotor Group, German Primate Center, Göttingen, Germany

²Faculty of Biology and Psychology, University of Göttingen, Göttingen, Germany

³Institute for Neuromodulation and Neurotechnology, University Hospital and University of Tübingen, Tübingen, Germany

⁴Leibniz ScienceCampus Primate Cognition, Göttingen, Germany

⁵Bernstein Center for Computational Neuroscience, Göttingen, Germany

Sensory prediction errors are thought to be one of the main drivers of motor adaptation, resulting from a mismatch between the sensory feedback that was internally predicted and the one that was actually received. Optimal integration theory suggests that each of these sources should be weighted by their uncertainty, so that when sensory feedback is highly uncertain the rate of adaptation should be reduced. Behavioral studies in human subjects have indeed shown that movement corrections are reduced when visual feedback of hand position is made more spatially uncertain. Specifically targeting implicit motor adaptation by using a non-contingent error-clamp perturbation, a recent study showed that with high feedback uncertainty, adaptation was attenuated for small but not for large errors, potentially because for small errors the estimated location of the hand relative to the target could be mistaken. Yet, most previous studies only provided terminal feedback of movement. Here, we probed the effect of visual feedback uncertainty on motor adaptation while providing this feedback continuously throughout movement. In this way, sensory prediction errors can be continuously computed, which has been found to affect adaptation, and highlights the behavioral relevance of feedback.

We modulated the spatial uncertainty of visual feedback by having subjects control a cursor (low uncertainty) or a cloud of five randomly moving dots (high uncertainty). Each one of these dots had an initial position that was drawn from a normal distribution centered around the subjects current true hand position, and also had a short lifetime upon which another dot appeared at a different location. Subjects performed the experiment in a 2D virtual reality environment to avoid view of their arm. They had to control a haptic manipulandum that provided the readout for their hand position. The main task was to perform planar center-out reaches from a central point to one out of four targets arranged around an outer circle at the diagonal directions. To induce adaptation, we used a visuomotor rotation paradigm which included baseline (no perturbation), rotation (perturbation, 30 deg) and washout (no perturbation) blocks. In comparison to the previously mentioned study, we used contingent feedback and subjects were not informed of the perturbation, providing a more naturalistic setting. Each subject was assigned to one of the two uncertainty conditions, controlling either the cursor or the cloud throughout the three visuomotor rotation blocks. Preliminary results show that, during baseline, movement variability was increased with high feedback uncertainty. Moreover, the rate of adaptation and the final level of adaptation was lower with high feedback uncertainty. Overall, our findings are in line with optimal integration theory, and showcase how the presence of visual feedback throughout movement can influence the relevance it is given to guide motor adaptation.

The interplay of behavioral rules and feedback during social behavior

Sarath Ravindran Nair¹, Jan Clemens^{1,2,3}

¹European Neuroscience Institute, Neural Computation and Behavior Lab, Grisebach Str. 7, 37077 Goettingen, Germany

²Bernstein Center for Computational Neuroscience, Göttingen, Germany

³corresponding author, contact: clemensjan@gmail.com

Social interactions are shaped by an individual's own actions and the resulting feedback from the interaction partner. Interactions with different partners can vary, but the relative contribution of an individual's own actions vs. the partner's feedback to this variation is often unclear. For example, interactions between friends differ from interactions between strangers: Either because an individual uses different rules to interact with a friend and a stranger. Or because a friend provides different social feedback than a stranger. At the same time, individuals are often able to maintain certain aspects of behavior in spite of the varying social cues that arise from target-specific feedback. For instance, we can maintain a friendly demeanor, irrespective of whether we get friendly or hostile feedback.

We address the interplay of behavioral rules and feedback using the courtship of *Drosophila melanogaster* as a model. During courtship, males dynamically process sensory feedback from the female to pattern their courtship song. The male is typically behind the female and a receptive female slows down in response to song to allow the male to interact and eventually copulate. Interestingly, *Drosophila* males also court other males and these interactions look remarkably different: the target male often speeds up in response to the song and sings back or is aggressive. Notably, male-male pairs often interact head-to-head, something that virtually never occurs in male-female interactions, which are typically head-to-tail.

We first asked whether the target sex-specific position of the male arises from a target-specific positional preference of the male courter or from different reactions from the courtship target. In other words, does the courter or the target initiate the head-to-head state? We found that the head-to-head state is almost always initiated by the male target turning towards the courter. This reaction is caused by song, since removing song by muting or deafening one male abolished the head-to-head states. Our results show that the reactions of the target, and not a change in the actions of the courter, drive the differences in interactions towards different partners.

These target sex-specific differences in the interaction lead to different visual cues for the male to pattern his song. Surprisingly, despite the sex-specific differences in cues, the song statistics are remarkably similar during male- and female directed singing. This could be because the rules that pattern the song change with or adapt to the target sex. Or because these rules are robust to the sex-specific behavioral feedback. To this end, we identified the rules that pattern the song using computational modeling. This shows that males use the same three rules to sing towards both sexes: Models with target-specific strategies do not outperform a target-agnostic model and the three rules are used equally frequently for male and female targets. Looking at the rules, we find that they are robust to the sex-specific behavioral feedback, explaining how similar behavior can emerge despite variable feedback from interacting partners.

In summary, our results show that while the target-specific feedback leads to differences in interactions, robust behavioral rules can pattern consistent social behaviors irrespective of these differences.

Unraveling *Drosophila* curve walking behavior

Ezequiel Axel Gorostiza¹, Till Bockemühl¹, Kei Ito¹, Ansgar Büschges¹

¹Universität zu Köln, Institut für Zoologie, Zülpicher Straße 47 b, 50674 Köln, Germany

From seeking partners or searching for food, to escaping from a threat, moving is a fundamental feature for countless animal species. Terrestrial animals, such as arthropods, displace across the environment thanks to the execution of coordinated movements of their jointed limbs, for which kinematic parameters and movement sequences are modified to fulfill actual behavioral demands. Insects, for example, adjust their step cycle period and stance duration in order to control speed during straight walking, while their leg coordination patterns change gradually from a predominant tripod coordination at high speed, to tetrapod at intermediate speeds and what resemble “wave gaits” at lower speeds (e.g. Wosnitz et al. 2013). However, only limited insight exists for changes in interleg coordination in situations, when the behavioral goals require more complex alterations, e.g. for generating turns in locomotion (e.g. Dürr, 2005). To address this question, we use the fruit fly due to its highly versatile behavioral performance and the opportunity to subsequently access neural mechanisms by means of the neurogenetic toolbox offered. Curve walking presents an interesting readout of the motor system in insects: while during straight walking contralateral pairs of legs in each segment produce similar but anti-phasic steps, during the generation of turns the motor system must operate by breaking contralateral symmetry and generate marked modifications in leg stepping kinematics differing between both sides. To address these questions, we analyzed 416 videos of free walking flies with nonlinear trajectories. We described three major strategies employed by the flies to produce curve walking; adjustments, arcs, and turns. Adjustments and arcs can be performed with higher forward speeds than turns, and their pivot point is far from the body, while for turns the pivot point is very close to the animal. Kinematic parameters from arcs resemble those from straight walking, while turns present distinctive differences, e.g. in stance durations. We also found differences in the temporal phase relationship between legs from the inner and the outer side of the curves. Our analyses suggest that contralateral asymmetries required for curve walking increase when forward walking speed decreases through the different strategies.

Supported by DFG-grant Bu857/15-1 and IT/9-1.

Unraveling the frequency- and layer-specific effects of high-frequency STN stimulation in mice in vivo

Svenja Kreis¹, Heiko J. Luhmann¹, Sergiu Groppa², Daniela Mirzac^{2,3}, Muthuraman Muthuraman²

¹University Medical Center of the Johannes Gutenberg University Mainz, Institute of Physiology, Duesbergweg 6, 55128 Mainz, Germany

²Department of Neurology, Focus Program Translational Neuroscience, Rhine Main Neuroscience Network, University Medical Center of the Johannes Gutenberg University Mainz, Langenbeckstr. 1, 55131 Mainz, Germany

³Nicolae Testemitanu State University of Medicine and Pharmacy, Chisinau MD-2001, Republic of Moldova

Background: High-frequency deep brain stimulation (DBS) of the STN is widely used to treat movement disorders, such as Parkinson's disease (PD). However, despite its widespread clinical use, its therapeutic mechanisms and the frequency- and layer-specific effects on the connectivity between STN and different areas of the motor cortex are mainly unknown.

Methods: In this study, we performed multi-site extracellular recordings of spontaneous neuronal activity of STN and all RFA- (proposed homolog to the PMC) and CFA-layers (proposed homolog to the M1) to gain insight into the connectivity between these areas in lightly anesthetized mice in vivo. Additionally, neuronal activity in the three areas was recorded during high-frequency stimulation of the STN (at 50, 140, 160, and 180 Hz). Therefore 8-14 weeks old C57Bl6-N mice were anesthetized with 1 mg/g urethane (i.p.). Two craniotomies were performed over STN, RFA, and CFA. Silicone MEA electrodes were inserted into STN, CFA, and RFA. This study focuses on the beta and high gamma frequency bands. Correct electrode placement was verified using histology. The effect of the STN stimulation on the oscillatory proxies was analyzed between the three regions using LFP coherence and the causality with time-resolved partial directed coherence. Additionally, β - and γ -bursts were analyzed.

Results: Our results confirm that high-frequency stimulation of the STN does reduce the number of long β -bursts in RFA, CFA and STN. Furthermore, we showed that the spectral power in RFA and CFA is significantly increased only at 160Hz STN stimulation in the high γ frequency band. This effect was significantly stronger in RFA as compared to CFA. Additionally, we could show that the coherence between RFA, CFA, and STN was significantly reduced due to 160Hz STN stimulation in the β - and high γ frequency band. Using tPDC, we furthermore demonstrated that the flow of information from STN towards RFA and CFA is reduced due to high-frequency STN stimulation. In contrast, the flow of information from the cortex towards STN is unchanged. Lastly, we showed that the number, length, and amplitude of long β - and γ -bursts in RFA, CFA, and STN are reduced due to 160 Hz STN stimulation.

Discussion: Using a combination of LFP power, LFP coherence, and tPDC we were able to clearly show that high-frequency STN stimulation with 160Hz has a significant, layer and frequency-specific effect on the effective functional connectivity between STN, RFA, and CFA. Our results provide insights into the effect of DBS on the motor cortex network of lightly anesthetized, adult wild-type mice, which provide answers for some questions on the mechanism of action of DBS.

Using a Multi-Network Approach with DeepLabCut to Improve Automatic Pose Estimation

Terrence Michael Wright^{1,2}, Till Bockemühl¹, Ansgar Büschges¹

¹Universität zu Köln, Department of Animal Physiology, 47b Zülpicher Str, 50674 Köln, Germany

²California State University, Sacramento, Department of Biological Sciences, 6000 J Street, 95819 Sacramento, California, USA

Multiple software packages are now available to perform marker-less pose estimation, which has provided new insights into how behaviors are produced and/or coordinated. A major goal of these programs is to estimate these poses with as little error as possible. There are two primary sources of error: the error inherent in the network itself and any human error in the annotation of the frames used to train the model. Several metrics have been developed (Root Mean Square Error, e.g.) to minimize the error between the trained network and the object of interest. Ultimately, however, any significant errors that occur during the annotation step typically need to be corrected via human intervention and, optionally, a follow-up re-training on frames of interest. This re-training improves the output of the trained network, but does not completely eliminate these network errors.

To address this, we propose a multi-network approach, in which a video sequence of interest is analyzed not by a single network but by multiple networks. Here, we use a diverse set of videos of freely walking fruit flies. In these videos, we are interested in several important body parts for pose estimation, like the tarsal tips or the front and back of the animal. We hypothesize that for any position of interest within a video frame

1) errors across networks will be rare and

2) these errors will be sufficiently distinct (i.e., a significant pixel distance) from other networks analyzing the same position in the same video frame.

To explore this hypothesis, we trained ten DeepLabCut networks using 100 frames selected from videos of ten different flies (1000 frames total across all ten videos.) These networks will thus be composed of distinct subsets of frames for each of ten flies, which should make the resulting networks generalizable to data from new individual flies. At the same time, while these ten networks will be structurally similar, they crucially have been trained on different training data sets.

Each trained network will be used to analyze novel videos of flies, and a metric will be generated that will produce a more reliable estimate of the position of interest across the ten networks as opposed to a single trained network. For any pose of interest, we will use k-means clustering to identify networks that identify the same position and/or a combined log-likelihood estimate of position from across the ten networks to produce a likelihood “surface” that provides the best likelihood estimate of the pose. With this new approach, we hope to make pose estimation more robust and automated and thus reduce the need for human intervention.

Using Neuropixels recordings to probe the stability of latent variables of the cortical grasping network in primates

Roberta Nocerino¹, Jan Churan¹, Hansjörg Scherberger^{1,2}

¹Deutsches Primatenzentrum GmbH, Leibniz-Institut für Primatenforschung, Göttingen, Germany

²Faculty of Biology, Georg-August-Universität Göttingen, Göttingen, Germany.

In everyday life, humans and monkeys perform a wide variety of grasping movements. In both species, the kinematics of grasping depends on the characteristics of the object to be grasped. Considering that different objects can be grasped in various ways, it is not surprising that neither humans nor monkeys use a default grip, but rather specific grasps for different objects and intended actions. The frontoparietal grasping network is involved in the organization of such movements, which includes the anterior intraparietal area (AIP), the ventral premotor cortex (F5) and the primary motor cortex (M1). Neurons in AIP are selective for the shape and orientation of objects to be grasped, whereas neurons in F5 more strongly represent the type of grip used to grasp the object and neurons in M1 are predominantly active during movements. To investigate the structure of populations of spiking activity (latent variables) in different locations of this network and when the same behavior is repeated on different days, we trained macaque monkeys to perform a visually instructed delayed grasping task in which the animal was instructed to grasp twelve different objects presented on two pc-controlled turntables. To obtain information about hand kinematics, the monkey performed the task with a data glove. Finally, to record simultaneously populations of hundreds of neurons, we established a new methodology of using Neuropixels probes in the monkey. Whereas this recording technology is already widely used in rodents, applications in the brain of non-human primates still represents a challenge. The presence of a thicker dura mater typically prevents the electrodes to penetrate. To mitigate this problem, we employed a 3-mm long guide tube that enabled the probe to safely penetrate the dura and enter the brain without risk of getting broken.

Using this methodology, we have successfully recorded from two cortical areas (AIP and F5). In a first analysis, we confirmed differences in reaction and movement time when grasping different objects as well as the presence of coding differences of individual neurons in AIP and F5 when grasping different objects. Furthermore, we were able to decode these grasping movements from the recorded neural population activity using a Naïve Poisson Bayes decoder, obtaining a decoding accuracy > 60%.

So far, we have confirmed that Neuropixels probes are suitable to replicate results obtained previously with more traditional probes. As a next step, we will now investigate the properties of large neuronal populations that can be recorded with Neuropixels while animals perform complex grasping actions. This will bring us several steps closer to understanding the structure and dynamics of cortical population activity during goal-directed grasping actions.

Walking speed affects spatial and temporal variability of leg movements in freely walking *Drosophila melanogaster*

Vincent Godesberg¹, Ansgar Büschges¹, Till Bockemühl¹

¹University of Cologne, Animal physiology, Zülpicher Straße 47b, 50674 Cologne, Germany

When studying the walking behavior of animals, walking speed always proves to be one of the most important aspects to consider. In this context, most other parameters such as stepping frequencies, duty cycles, phase relations, or interleg coordination patterns are highly correlated with walking speed. This can be seen most prominently in large vertebrates, in which changes in walking speed are accompanied by obvious gait changes. But also walking insects, in which these clear gait changes are absent, show clear speed dependencies of several spatial and temporal parameters in walking. Furthermore, previous studies implicitly suggested that there might also be an additional inverse correlation between walking speed and the variability of leg movements in insects; these data suggest that several kinematic parameters become less variable at higher walking speeds. This finding seems to be counter-intuitive at first, but might be explained by a speed-dependent reduction of sensory information, thus reducing noise and variability in the generation of motor output. More detailed investigations of these aspects, however, were fairly difficult for the longest time, since the crucial prerequisite is an extensive data basis that covers a large portion of the walking speed range and acquisition of high-quality data of walking animals was very labor-intensive until recently.

In this study, we used a deep artificial neural network approach to drastically enhance the process of extracting kinematic data from videos of freely-walking *Drosophila*. This approach delivered high-quality results comparable to manual annotations and enabled an almost 50-fold faster data analysis. The resulting data set contained the body and leg tip positions of over 100,000 steps taken during normal, straight walking in a total of 103 individual male wildtype flies. Leg tip positions were normalized to body length (BL) and walking speed was calculated accordingly. Stance phases were determined automatically by identifying sequences in which individual leg tips did not move relative to the walking substrate. Anterior and posterior extreme positions (AEPs and PEPs, i.e. touchdown and lift-off positions) served as the basis for the spatial variability measure. Furthermore, for measurement of temporal variability, the phase relations between ipsi- and contralateral leg pairs were determined. All steps were distributed into bins of 1 BL s⁻¹ width and mean variability values were normalized for better comparability.

We found that freely-walking *Drosophila* show a clear decrease in both spatial and temporal variability with increasing walking speeds. For AEPs and PEPs the effect was highly similar and on average linear over the whole walking speed range. For the phase relations, i.e. the temporal coordination, it was more pronounced than for the spatial variability for contralateral pairs of middle and hind legs as well as for all ipsilateral leg pairs, while the effect was weaker for the phase relations between front legs. The variability of phase relations on average decreased most strongly between 3 and 6 BL s⁻¹ and was relatively constant at higher walking speeds. Based on these findings, we have developed multiple hypotheses to explain the observed effects and came up with concrete experimental approaches to test them, including inhibition experiments with chloride selective channelrhodopsins.

Poster Topic

T22: Homeostatic and Neuroendocrine Systems, Stress Response

- [T22-1A](#) „Satiety vs. Starvation “– Neuropeptidomics of the central nervous system of *Drosophila melanogaster* L3-larvae
Anna-Sophie Kügler, Susanne Neupert
- [T22-2A](#) Calcium dependent mechanisms to establish neuronal homeostatic setpoints
Niklas Krick, Richard Baines, Matthias Landgraf
- [T22-3A](#) Cell-specific function of the thyroid hormone transporters Mct8 and Oatp1c1 in mouse blood-brain barrier cells
Androniki Alevyzaki, Boyka Markova, Steffen Mayerl, Heike Heuer
- [T22-5A](#) Connection of MC3R neurons and their role in stress responses
Jiajie Zhu, Rachel Lippert, Selma Yagoub, Lídia Cantacorps, Katrin Ritter, Robert Chesters
- [T22-6A](#) Dopaminergic signaling in the arcuate nucleus of the hypothalamus
Svenja Corneliussen, Isabella Gaziano, Nasim Biglari, René Neuhaus, Linyan Shen, Tamara Sotelo Hitschfeld, Paul Klemm, Lukas Steuernagel, Alain de Solis, Weiyi Chen, F. Thomas Wunderlich, Jens C. Brüning, Peter Kloppenburg
- [T22-7A](#) Energy homeostasis and melanocortin receptors of the paraventricular thalamus
Robert Chesters, Bethany Coull, Lydia Palm, Katrin Ritter, Rachel Lippert
- [T22-1B](#) Homeostatic signaling helps cooled fish larvae escape from ballistic predators
Alexander Hecker, Stefan Schuster
- [T22-2B](#) Impact of thyroid hormone transporter Mct8/Oatp1c1 deficiency on hippocampal GABAergic and glutamatergic systems in the mouse CNS
Andrea Alcaide Martin , Heike Heuer, Steffen Mayerl
- [T22-3B](#) Insulin-like signalling together with the serotonin transporter regulate appetite in *Drosophila melanogaster*
Magdalena Gompert, Katharina Dorn, JianZheng He, Henrike Scholz
- [T22-4B](#) Integrated cardio-behavioural defensive states
Jérémy Signoret-Genest, Nina Schukraft, Sara L. Reis, Dennis Segebarth, Philip Tovote

- [T22-5B](#) Maternal diabetes and metformin exposure affect offspring brain development in a sex-dependent manner.
Lidia Cantacorps, Jiajie Zhu, Selma Yagoub, Lea-Sophie Kasch, Maya Paterson, Miguel Serrano-Lope, Rachel Lippert
- [T22-6B](#) Sepsis-like Bacterial infection modulates innate Behaviour in *Drosophila melanogaster*
Thomas Riemensperger, Fabienne Reh, Kei Ito
- [T22-7B](#) Impaired cerebrovascular reactivity and elevated levels of carbon dioxide – central regulation of combined peripheral effects
Dorothea Ziemens, Marius Richter, Ákos Menyhárt, Eszter Farkas, Markus Schwaninger, Jan Wenzel
- [T22-8B](#) Stimulation of autophagy in hippocampal neurons by Neuropeptide Y
Ines Erdmann, Gina Marie Krause, Elisa Redavide, Anke Müller, Daniela C. Dieterich, Oliver Stork, Anne Albrecht
- [T22-1C](#) Tanycytic thyroid hormone (TH) signalling in the regulation of hypothalamic functions and hormone uptake
Akila Chandrasekar, Sebastain Abele, Anke Fähnrich, Frauke Spiecker, Jens Mittag, Markus Schwaninger, Helge Müller-Fielitz
- [T22-2C](#) Temperature-dependent variability of detectable neuropeptide titers in individual *Drosophila* neurons by quantitative immunolabelling
Inga Schirmer, Susanne Neupert
- [T22-3C](#) The role of BDNF^{LH} neurons in the regulation of feeding behaviour
Carolin Schumacher, Anne Petzold, Tatiana Korotkova
- [T22-4C](#) The role of orexin receptors 1 and 2 in serotonergic neurons of raphe nuclei
Gagik Yeghiazaryan, Xing Xiao, Simon Hess, Paul Klemm, Anna Sieben, André Kleinriders, Donald Morgan, Thomas Wunderlich, Kamal Rahmouni, Dong Kong, Thomas Scammell, Bradford Lowell, Jens Brüning, Christine Hausen, Peter Kloppenburg
- [T22-5C](#) The Role of TRH Neurons in Energy Homeostasis and Regulation of Brown Adipose Tissue
Andreea Constantinescu, Luka Höhne, Jens Mittag, Helge Müller-Fielitz, Markus Schwaninger
- [T22-6C](#) 3-D STED Imaging of Tanycytes
Surya Prakash Rai, Helge Müller-Fielitz, Markus Schwaninger
- [T22-7C](#) Sleep deprivation increases performance in larval zebrafish decision making
Hanna Zwaka, Paula Pflitsch, Will Joo, Kumaresh Krishnan, Nadine Oury, Armin Bahl, Declan Lyons, Jason Rihel, Florian Engert
- [T22-8C](#) Transgenerational effects of early life stress on DNA methylation of the Oxytocin receptor promoter (OxtR) in mouse brain and peripheral tissues.

Brigid Chimoita Aliero, Nicole Gröger, Alexandra Lesse, Kathrina Braun, Jörg Bock

[T22-9C](#) Complementary lateral hypothalamic populations resist hunger pressure to balance nutritional and social needs

Anne Petzold, Hanna Elin van den Munkhof, Rebecca Figge-Schlensok, Tatiana Korotkova

[T22-10C](#) A role of the oxytocin signaling in the hypothalamus for social fear learning

Takuya Osakada, Yiwen Jiang, Rongzhen Yan, Rina Tabuchi, Dayu Lin

„Satiety vs. Starvation “– Neuropeptidomics of the central nervous system of *Drosophila melanogaster* L3-larvae

Anna-Sophie Kügler¹, Susanne Neupert¹

¹Universität Kassel , Institute of Biology, Section: Animal Physiology, Heinrich-Plett-Str. 40, 34132 Kassel, Germany

Starvation is induced by a lack of nutrients and energy and drives eating and food-seeking behavior. In addition, hunger is a guidance signal that ensures that the search for food only takes place when needed. This occurs via neuronal signals such as neuropeptides. Neuropeptides are shorter peptide molecules of a length up to 45 aa produced by neuronal and endocrine cells. They are processed from larger preproteins that contain a signal peptide and canonical prohormone convertase processing sites, and executes functions as neuromodulator or hormone via G- protein- coupled receptor (GPCR)- signaling.

To uncover potential peptidergic candidates which are involved in the regulation of feeding, we used tissue extract analysis by matrix-assisted laser desorption/ionization time-of-flight (MALDI-TOF) MS and Q-Exactive Orbitrap mass spectrometry (MS) to investigate the neuropeptidome of L3 *Drosophila* larvae under fed and starved condition. Therefore, CNS samples from three different test groups are tested: (1) non-starved, (2) 24 hour starved, and (3) 48 hours starved larvae. Statistical comparison of resulting mass spectra revealed changes in the ion signal intensities of products of ten neuropeptide genes (pyrokinin (hugin gene), short neuropeptide F, myosuppressin, corazonin, allatostatin-C, diuretic hormone-44, neuropeptide-like precursor-1, extended fmrfamide, sif amide, kinin).

By applying Q-Exactive Orbitrap MS, we could confirm the amino acid composition of these neuropeptides by fragmentation analysis. In addition, we found dynamics in the intensity of ion signal under different feeding conditions which are not match with known *Drosophila* neuropeptides. The sequence of the molecules has to be characterize in further experiments using de novo sequencing and BLAST data bank search.

The results of our study provide necessary input for future measurements up to single cell level to study the dynamic in up- and downregulation of neuropeptides underlying mechanisms regulating feeding.

Calcium dependent mechanisms to establish neuronal homeostatic setpoints

Niklas Krick¹, Richard Baines², Matthias Landgraf¹

¹University of Cambridge, Department of Zoology, United Kingdom

²University of Manchester, Division of Neuroscience, United Kingdom

The properties of neuronal networks required for normal function are specified during a phase of development that is referred to as a critical period. Transient activity perturbations during a critical period cause mis-specification of neuronal properties with lasting consequences to network function. In humans, suboptimal critical period experiences are thought to be associated with neuro-developmental or neuro-psychiatric conditions. How critical period activity patterns are translated into structural and physiological changes, is currently not well understood.

To address this fundamental question, we are taking advantage of the well characterised and tractable *Drosophila* larval locomotor network, which also has a clearly defined critical period; in late embryogenesis, coincident with the transition from spontaneous unpatterned to coordinated patterns of neuronal activation. Our aim is to identify the cellular and molecular substrates which together define the homeostatic setpoint of the locomotor circuitry. Ectothermic animals, such as *Drosophila*, are particularly susceptible to changes in temperatures during their development, which when experienced during the critical period, cause morphological, physiological and behavioural changes that last beyond embryogenesis and throughout larval life. For example, transient embryonic experience of 29°C or 32°C cause changes in neuromuscular junction growth, transmission and larval crawling behaviour. Interestingly, the observed pre- and postsynaptic responses differ from those expected based on homeostatic plasticity mechanisms known in the field and can provide novelty for the understanding of homeostatic adaptation.

My aim is to understand how neurons translate transient critical period perturbations into lasting cellular adaptations. I am particularly interested in exploring potential roles for calcium in translating critical period experiences and regulating adaptive mechanisms that contribute to establishing homeostatic setpoints, because in neurons, calcium serves a dual function, as charge carrier and second messenger. To test this, I expose embryos to high temperatures and concomitantly manipulate, in single cells, calcium signalling pathways during the critical period, e.g. cell targeted knockdowns to either disrupt calcium extrusion or activity dependent calcium influx. Experiencing 32°C during the critical period reliably leads to increased presynaptic growth and bouton number at the larval neuromuscular junction. Preliminary data suggests, that this critical period-specified presynaptic terminal growth relies on calcium signalling.

In order to determine how changes in synaptic size and morphology correlate with altered physiology, I am using two electrode voltage clamp to analyse critical period-induced changes to synapse physiology, either caused by transient changes in calcium signalling during the critical period and/or 32°C temperature exposure.

Cell-specific function of the thyroid hormone transporters Mct8 and Oatp1c1 in mouse blood-brain barrier cells

Androniki Alevyzaki¹, Boyka Markova¹, Steffen Mayerl¹, Heike Heuer¹

¹University Hospital Essen, University Duisburg-Essen, Department of Endocrinology, Diabetes & Metabolism, Hufelandstrasse 52, 45147 Essen, Germany

Thyroid hormones (TH) are essential for proper CNS development and function. For passing the blood-brain-barrier and entering neural target cells TH requires transmembrane transporters. Mice with combined deficiency in the TH transporters Mct8 and Oatp1c1 (Mct8/Oatp1c1 dko mice) display a strongly diminished TH passage into the brain and, consequently, a disturbed neuronal maturation, myelination as well as locomotor abnormalities. As both transporters are expressed in several neural cell types, the exact cell-specific function of Mct8 and Oatp1c1 in brain barrier cells remains to be defined.

To address this question, we generated mice lacking Mct8 and/or Oatp1c1 specifically in endothelial cells (= Endo del mice) by crossing conditional Mct8 flox and Oatp1c1 flox animals with mice expressing Cre-recombinase under the constitutively active Tie2 promoter. To eliminate Mct8 and/or Oatp1c1 specifically in astrocytes in the adult CNS (=Astro del mice), we took advantage of a Tamoxifen-inducible Aldh1l1 CreERT2 mouse line and crossed it with conditional Mct8/Oatp1c1 flox mice. Both Mct8/Oatp1c1 Astro del and Endo del mice were phenotypically indistinguishable from their control littermates. By monitoring Cre recombinase activity with a reporter protein, we confirmed a cell-specific recombination in astrocytes and endothelial cells, respectively.

Immunofluorescence analysis revealed a strongly reduced number of Parvalbumin-positive neurons in the cerebral cortex of Endo del mice, similarly to the phenotype seen in global Mct8/Oatp1c1 deficiency. In contrast, myelination was less compromised in mice lacking Mct8/Oatp1c1 only in endothelial cells compared to global Mct8/Oatp1c1 dko mice. In comparison, Astro del mice did not show any alterations regarding myelination or interneuron marker expression. Furthermore, analysis of TH target gene expression by FISH revealed only mild changes in Astro del mice while Endo del animals exhibited strongly reduced expression levels indicating a TH deficient state in the CNS. Altogether, our data point to a critical role of Mct8 and Oatp1c1 in mediating TH transport across endothelial cells whereas cellular TH passage in astrocytes appears to be only mildly compromised in the absence of Mct8 and Oatp1c1.

Connection of MC3R neurons and their role in stress responses

Jiajie Zhu^{1,2}, Rachel Lippert^{1,3}, Selma Yagoub^{1,2}, Lídia Cantacorps¹, Katrin Ritter¹,
Robert Chesters¹

¹Deutsches Institut für Ernährungsforschung Potsdam-Rehbrücke, Germany

²University of Potsdam, Germany

³NeuroCure Cluster of Excellence, Charité-Universitätsmedizin Berlin, Germany

In modern society, stress has become a common trigger for inappropriate eating behaviors, yet the mechanism behind is not well established. The central melanocortin system is known to be the key regulator of energy homeostasis, it is mediated through a family of five related G protein-coupled melanocortin receptors, MC1R through MC5R, whereas only MC3R and MC4R are expressed in the brain. Mice lacking MC3R have been shown to have abnormal responses to fasting, shown by inappropriate refeeding behavior and altered corticosterone levels. However, where these MC3R neurons are acting to mediate effects of nutritional stresses such as fasting is unknown. In addition, recent work shows a role for MC3R in social behaviors as well. Therefore, we studied the role of MC3R modulation in two different stress paradigms (nutritional and non-nutritional). Further, we identified innervation of MC3R neurons to target sites using the MC3R-Cre; ROSA26-LSL-Synaptophysin-TdTomato mouse model. One site identified as a target of MC3R neurons was the amygdala. Interestingly, we found out a distinct pattern of MC3R projections to the central Amygdala and completely absent of projection to the basolateral amygdala (BLA). The amygdala is responsible for fear response, reward mechanisms and promoting anxiety-like behavior. We hypothesize, MC3R regulates neuronal circuits projecting to the AMY to mediate food intake under stress situations.

Dopaminergic signaling in the arcuate nucleus of the hypothalamus

Svenja Corneliussen^{1,2}, Isabella Gaziano^{1,3,4}, Nasim Biglari^{1,3,4}, René Neuhaus^{1,3,4}, Linyan Shen^{1,3,4}, Tamara Sotelo Hitschfeld^{1,3,4}, Paul Klemm^{1,3,4}, Lukas Steuernagel^{1,3,4}, Alain de Solis^{1,3,4}, Weiyi Chen^{1,3,4}, F. Thomas Wunderlich^{1,4,5}, Jens C. Brüning^{1,3,4,6}, Peter Kloppenburg^{1,2}

¹Excellence Cluster on Cellular Stress Responses in Aging Associated Diseases (CECAD) and Center of Molecular Medicine Cologne (CMMC), University of Cologne, Joseph-Stelzmann-Str. 26, 50931 Cologne, Germany

²Institute for Zoology, Biocenter, University of Cologne, Germany

³Max Planck Institute for Metabolism Research, Department of Neuronal Control of Metabolism, Gleueler Str. 50, 50931 Cologne, Germany

⁴Center for Endocrinology, Diabetes and Preventive Medicine (CEDP), University Hospital Cologne, Kerpener Str. 26, 50924 Cologne, Germany

⁵Max Planck Institute for Metabolism Research, Department of Obesity and Cancer, Gleueler Str. 50, 50931 Cologne, Germany

⁶National Center for Diabetes Research (DZD), Ingolstädter Landstrasse 1, 85764 Neuherberg, Germany

The arcuate nucleus of the hypothalamus (ARC) contains functionally antagonistic neuron populations, which play a crucial role in regulating homeostatic food intake and energy homeostasis. These neuron populations are the orexigenic agouti-related peptide (AgRP) and neuropeptide Y (NPY) expressing neurons, as well as the anorectic proopiomelanocortin (POMC) and cocaine- and amphetamine-regulated transcript (CART) expressing neurons. These neurons sense and integrate multimodal endocrine and neuronal signals that reflect the energy status of the body. The feeding response upon sensing an energy depletion is called homeostatic feeding and is mainly regulated in the ARC. In contrast, hedonic feeding refers to feeding beyond the body's nutritional needs and is mainly controlled by neuronal networks in the mesocorticolimbic system. One of the most important neurotransmitter in the mesolimbic system is dopamine, which is significantly involved in the rewarding effects of food intake. The neuronal connection between the ARC and mesocorticolimbic systems has been studied intensively. However, less is known about the direct action of dopamine on POMC and AgRP neurons. In this study, we addressed this question using newly developed mouse models where intersectional Cre/Dre-dependent recombination allows successful labeling, translational profiling and electrophysiological characterization. We found that POMC neurons mainly express the inhibitory Drd2 receptor (~30 %), while AgRP neurons mainly express the excitatory Drd1 receptor (~15 %). Accordingly, perforated patch clamp experiments showed that dopamine application excited most of the AgRP neurons in a dose-dependent manner, whereas most of the POMC neurons were inhibited. Using a newly generated mice line targeting only POMC^{Drd2+} neurons, we show that the dopamine inhibition is Drd2-dependent and that these neurons express different neuropeptide signaling pathways compared to the general POMC population. This was highlighted by an enhanced expression of somatostatin receptors and increased responsiveness to somatostatin of POMC^{Drd2+} neurons. Furthermore, selective chemogenetic activation of POMC^{Drd2+} neurons uncovered their ability to suppress feeding acutely and preserve body temperature. Taken together, this study gave new insight into the understanding of the dopamine-dependent control of homeostatic feeding and provides a comprehensive characterization of POMC^{Drd2+} neurons.

Energy homeostasis and melanocortin receptors of the paraventricular thalamus

Robert Chesters¹, Bethany Coull¹, Lydia Palm^{1,2}, Katrin Ritter¹, Rachel Lippert^{1,3}

¹Neurocircuit Development and Function (NDF), German Institute of Human nutrition (DIfE), Potsdam-Rehbrücke Germany

²Humboldt Universität zu Berlin, Germany

³NeuroCure Cluster of Excellence, Charité - Universitätsmedizin Berlin, Germany

The melanocortin system is a key regulator of food intake and energy expenditure. Melanocortin receptors in the brain receive both orexigenic and anorexigenic input. Melanocortin receptor 3 (MC3R) is implicated in modulating feeding behaviour and body weight changes under different nutritional challenges. Moreover, deficiencies in MC3R can alter reward circuitry, and perturb energy homeostasis leading to mild obesity.

MC3R is highly expressed in the paraventricular nucleus of the thalamus (PVT): a brain region that integrates internal energy state with environmental stimuli to determine feeding and reward behaviours. However, little is known of the role of MC3R signalling within the PVT.

Preliminary immunohistochemical data from our lab indicates a significant increase in neuronal activity within the PVT after fasting. Thus we decided to further monitor the activity of PVT-MC3R neurons using fiber photometry recording and different nutritional challenges, to investigate their role in feeding behaviour and energy homeostasis.

Homeostatic signaling helps cooled fish larvae escape from ballistic predators

Alexander Hecker¹, Stefan Schuster¹

¹University of Bayreuth, Department of Animal Physiology, Universitätsstraße 30, 95440 Bayreuth, Germany

Fish use Mauthner cell (M-cell) initiated fast-starts to escape threats. These escapes slow down in cold waters and acclimate only in weeks or not at all. In encounters with most other ectothermic predators, that are equally slowed down, this would not matter - with one exception: Some ectothermic predators of fish larvae use so-called ballistic strikes whose speed is not affected by cooling because they release stored energy. Here we report that cooled zebrafish larvae unusually rapidly restore escape latency as well as their chances for surviving encounters with damselfly nymphs in the cold. Recovery of escape latency correlated surprisingly tightly with changes in the Ca^{2+} -influx that occurred in the M-cells after each escape. These correlated changes in post-response Ca^{2+} -influx involve homeostatic processes that are intrinsic to the M-cell as we show in experiments that circumvent the usual flow of information across sensory organs and the brain. Lastly, pharmacology suggests that these rapid adjustments require functional NMDAR, CaMKII and gap junctions. The tight coupling between Ca^{2+} -influx and escape latency couples processes of cellular homeostasis to homeostasis at the behavioral, ecologically relevant level – allowing zebrafish larvae to face the temperature-independent ballistic strikes of damselfly nymphs in cold waters.

Impact of thyroid hormone transporter Mct8/Oatp1c1 deficiency on hippocampal GABAergic and glutamatergic systems in the mouse CNS

Andrea Alcaide Martin¹, Heike Heuer¹, Steffen Mayerl¹

¹University Duisburg-Essen, University Hospital Essen, Dept. of Endocrinology, Diabetes and Metabolism, Hufelandstraße 55, 45147 Essen, Germany

The monocarboxylate transporter 8 (Mct8) and the organic anion transporting polypeptide 1c1 (Oatp1c1) are thyroid hormone (TH) transporters that are crucial for the passage of THs across the blood brain barrier and further into neural cells in the murine CNS. In neural cells, THs bind to nuclear receptors that regulate gene transcription and, thus, critical processes of brain development such as neurogenesis, progenitor migration, differentiation and synaptogenesis. Inactivation of both TH transporters in mice (Mct8/Oatp1c1 dKO mice) result in alterations in the CNS such as a reduced thickness of the cerebral cortex, impaired development of the cortical GABAergic system and increased seizure susceptibility. However, in these mice little is known about the hippocampus, a structure particularly sensitive towards the presence of TH and central in many forms of epilepsy. Here, we address the consequences of Mct8/Oatp1c1 deficiency for neuron development in the murine hippocampus. To this end, we first characterized the hippocampal inhibitory GABAergic system by immunofluorescence analysis at different postnatal stages. Assessment of inhibitory interneuronal markers (Gad67, Parvalbumin, Somatostatin) in young and adult mice revealed a delayed GABAergic system development in Mct8/Oatp1c1 dKO mice. Moreover, qPCR analyses indicated altered expression of GABA transporters and GABA transaminase suggesting increased GABA degradation in adult stages. Likewise, glutamate receptor subunit expression was assessed by qPCR demonstrating an increase in kainite receptor subunits (GluR6, GluR7, KA1, KA2) in adult stages that argues for increased excitatory neurotransmission. Together, these results point to an altered development of the hippocampal inhibitory and excitatory systems that could potentially impact neurotransmission and seizure susceptibility in the absence of Mct8 and Oatp1c1. Ongoing studies will reveal to which extent functional parameters are altered in Mct8/Oatp1c1 dKO mice and whether these abnormalities are caused by a neuron-autonomous function of these TH transporters.

Insulin-like signalling together with the serotonin transporter regulate appetite in *Drosophila melanogaster*

Magdalena Gompert¹, Katharina Dorn¹, JianZheng He¹, Henrike Scholz¹

¹University of Cologne, Department for Zoology, Zülpicher Straße 47b, 50674 Cologne, Germany

The energy homeostasis of animals is dependent on their internal energy levels and the availability of nutrients in their environment. To prevent diseases originating from uncontrolled food intake and maintain energy homeostasis the animals must adapt the intake of the two major nutrients carbohydrates and proteins, selectively. As in vertebrates in *Drosophila* the serotonergic system partially regulates the consumption of both. We show that different sets of serotonergic neurons regulate appetite- or hunger-driven consumption of a given nutrient. Further, insulin-like signalling regulates sucrose appetite by modulating serotonergic neuron activity. We provide evidence that the modulation is partially mediated by dislocation of the serotonin transporter within the serotonergic neurons resulting in increased serotonin signalling. Therefore, we provide evidence that insulin-like signaling in serotonergic neurons contributes to synaptic plasticity which influences food choice and prevents overconsumption by repressing the appetite for carbohydrates.

Integrated cardio-behavioural defensive states

Jérémy Signoret-Genest^{1,2}, Nina Schukraft¹, Sara L. Reis¹, Dennis Segebarth¹, Philip Tovote^{1,2}

¹Institute of Clinical Neurobiology, University Hospital Wuerzburg, Wuerzburg, Germany

²Center for Mental Health, University Hospital Wuerzburg, Wuerzburg, Germany

Fear and anxiety are brain states that evolved to mediate defensive responses to threat. While it is clear that the defence reaction includes multiple interacting behavioural, autonomic and endocrine adjustments, their integrative nature is poorly understood. In particular, under seemingly identical threat conditions, both deceleration (bradycardia) as well as acceleration (tachycardia) of heart rate (HR) have been reported, hampering consensus on the relevance and meaning of cardiac changes for the integrated defence reaction. By identifying stereotypical behavioural and HR dynamic associations at different timescales and under various conditions, we here define cardio-behavioural, rapid “microstates” and “macrostates”, characterized by slower dynamics. Interestingly, both micro-and macrostates reflect context-dependent threat levels, but we also found that macrostate dynamics can critically affect the expression of the most elemental cardio-behavioural elements (i.e. microstates), encompassing the most common readout for fear, i.e. the freezing response. In turn, optogenetics experiments designed accordingly revealed how integrated cardio-behavioural micro- and macrostates are mediated by specific circuit elements in the midbrain periaqueductal grey. Our work puts forth a framework for systematic integration of cardiac and behavioural readouts that presents the basis for a better understanding of complex neural defensive states and their associated systemic functions.

Maternal diabetes and metformin exposure affect offspring brain development in a sex-dependent manner.

Lídia Cantacorps^{1,2}, Jiajie Zhu¹, Selma Yagoub¹, Lea-Sophie Kasch¹, Maya Paterson¹, Miguel Serrano-Lope¹, Rachel Lippert^{1,2,3}

¹German Institute of Human Nutrition Potsdam-Rehbrücke, Neurocircuit Development and Function, Arthur-Scheunert-Allee 114-116, 14558 Nuthetal, Germany.

²German Center for Diabetes Research (DZD), Neuherberg, Germany.

³NeuroCure Cluster of Excellence, Charité-Universitätsmedizin Berlin, Germany.

Maternal gestational diabetes and excessive gestational body weight gain are associated with an increased risk of metabolic disorders for the offspring. Pharmacological treatments for gestational diabetes include insulin and metformin, the latter of which was only recently approved for its use during pregnancy. Both are effective in normalizing maternal glycemia; however, metformin, unlike insulin, is able to cross the placental barrier. The putative effects of metformin on offspring's brain development are still unknown, although recent clinical studies have shown increased adiposity in 9-year-old children born to metformin-treated mothers. Metformin is known to promote AMPK signalling, which has a key role on axonal growth during development. Overactivation of AMPK during early postnatal life may have an impact on axonal projection formation in the hypothalamus, which is a key player in the regulation of energy homeostasis and feeding behaviours. Thus, we aim to decipher the effects of the antidiabetic treatment exposure during the lactation phase on intra-hypothalamic neuronal connectivity formation in mice. To address this, female C57BL/6N mice were exposed either to control diet (CD) or high-fat diet (HFD) prior mating, during pregnancy and lactation to induce maternal diabetes. A third group of females were exposed to HFD during lactation. Insulin and metformin were given during the early postnatal weeks, which represents the human-equivalent period to the third-trimester of pregnancy, as would be seen in the human scenario. Then, offspring mice were sacrificed across postnatal development and brains were extracted. Agouti-related peptide (AgRP) and proopiomelanocortin (POMC) neuronal projections into the paraventricular nucleus of the hypothalamus (PVH) were assessed, as well as changes on AMPK signalling in the hypothalamus. According to our data, mothers receiving HFD only during the lactation resemble a model of excessive gestational body weight gain, as evidenced by their increase in body weight. Further, our results reveal a differential response to anti-diabetic interventions depending on the maternal nutritional status, as shown by differential effects on offspring's growth and circulating metabolic hormones. Maternal HFD led to a reduction of AgRP fibre density in anterior PVH nucleus, which could only be partially rescued by metformin treatment in males. A sexual dimorphism on AMPK signalling was also observed by Western Blot, with females being more sensitive to metformin-induced AMPK activation. Thus, we conclude that maternal overnutrition compromises the establishment of the hypothalamic neuronal network during early postnatal development and that these impairments do not appear to be rescued by metformin.

Sepsis-like Bacterial infection modulates innate Behaviour in *Drosophila melanogaster*

Thomas Riemensperger¹, Fabienne Reh¹, Kei Ito¹

¹Universität zu Köln, Experimentelle Morphologie / Neuroanatomie, Zùlpicher Straße 47b, 50674 Köln, Germany

Drosophila feed and live on fermenting fruits, favouring the exposure to potentially hazardous pathogens. Like many other eukaryotes fruitflies have evolved immunological mechanisms as well as adaptive behaviours to reduce the risk of infection and protect themselves against bacterial infection. Employing opto-physiological methods in combination with behavioral studies, our present study aims at investigating the neuronal pathways that integrate the information about a sepsis-like bacterial infection through *Erwinia carotovora carotovora* (*Ecc*) in the generation of behaviour. We found that sepsis-like infection is followed by a drastic reduction of feeding and increased spontaneous locomotor activity accompanied by a strong increase of neuronal activity in the ventral nerve cord of the fly. Our detailed anatomical analysis revealed that the neuronal circuits with increased neuronal activity are Leucokinin producing neurons and neurons expressing the Leucokinin receptor. Further, we found that two Leucokinin neurons employ dopamine as co-transmitter. To shed light on the role of the Leucokinin neuron circuits in the observed modulation of behaviour we knocked out components of the circuit and compared the repercussion on the behaviour of flies suffering from a sepsis-like bacterial infection and uninfected flies.

Impaired cerebrovascular reactivity and elevated levels of carbon dioxide – central regulation of combined peripheral effects

Dorothea Ziemens¹, Marius Richter¹, Ákos Menyhárt², Eszter Farkas², Markus Schwaninger¹, Jan Wenzel¹

¹University of Lübeck, Institute for Experimental and Clinical Pharmacology, Ratzeburger Allee 160, 23562 Lübeck, Germany

²University of Szeged, Department of Cell Biology and Molecular Medicine, Somogyi u. 4, 6720 Szeged, Hungary

Carbon Dioxide (CO₂) is a well-known metabolic end-product of cellular metabolism that is removed from organs by the blood stream and ultimately through respiration. Its main effects comprise vital functions including breathing, as well as behavioral changes like arousal and anxiety. These changes are to be considered as mechanisms that lead to the removal of CO₂ from the body. The removal and adaptation of the organism to varying concentrations of CO₂ are well described and occurs at different levels. For instance, CO₂ serves as one of the key regulators of cerebral blood flow, with hyper- and hypocapnia resulting in dilation and constriction of the cerebral vasculature, respectively. A loss of the physiological properties and functionality of the endothelium (endothelial dysfunction) encompasses a shift of vessels to a vasoconstrictive state. This phenomenon has not only been described as a secondary cause of metabolic diseases such as obesity but it has been described in primary neurological diseases such as Alzheimer's and Parkinson's disease. The extent to which endothelial dysfunction contributes to the severity of said diseases and the underlying molecular mechanisms are yet unknown. Recently, we developed a mouse model mimicking cerebral endothelial dysfunction that is induced by a knockout of the Gα_{q/11} signaling pathway specifically in brain endothelial cells (Gα_{q/11}^{beKO}).

We hypothesize, that the loss of cerebral vascular reactivity leads to impaired removal of CO₂ from the tissue and in turn, a change in the regulation of the cerebral carbon dioxide buffer system (e.g. changes in pH) as well as various systemic consequences.

For this purpose, we challenged Gα_{q/11}^{beKO} mice with a short CO₂ exposure, measuring cortical blood flow (by laser Doppler) and tissue pH (by pH-selective electrode) simultaneously. We could show that CO₂ induces pH changes in the brain tissue, which are aggravated in Gα_{q/11}^{beKO} mice. Additionally, we identified specific CO₂-sensitive brain areas (by *c-fos* expression) and could show that these cerebral pH changes drive peripheral effects, such as changes in body temperature regulation, which are enhanced in Gα_{q/11}^{beKO} mice. Using a direct brain area specific proton shift approach, we could provide results showing similar peripheral effects on temperature regulation.

Overall, our findings suggest, that cerebrovascular reactivity is essential for normal brain function and highlight the importance of central neural circuits driving peripheral metabolic effects. The mouse model investigated in this study provides a useful platform for further understanding the contribution of cerebral endothelial dysfunction with its associated consequences to diseases like the metabolic syndrome.

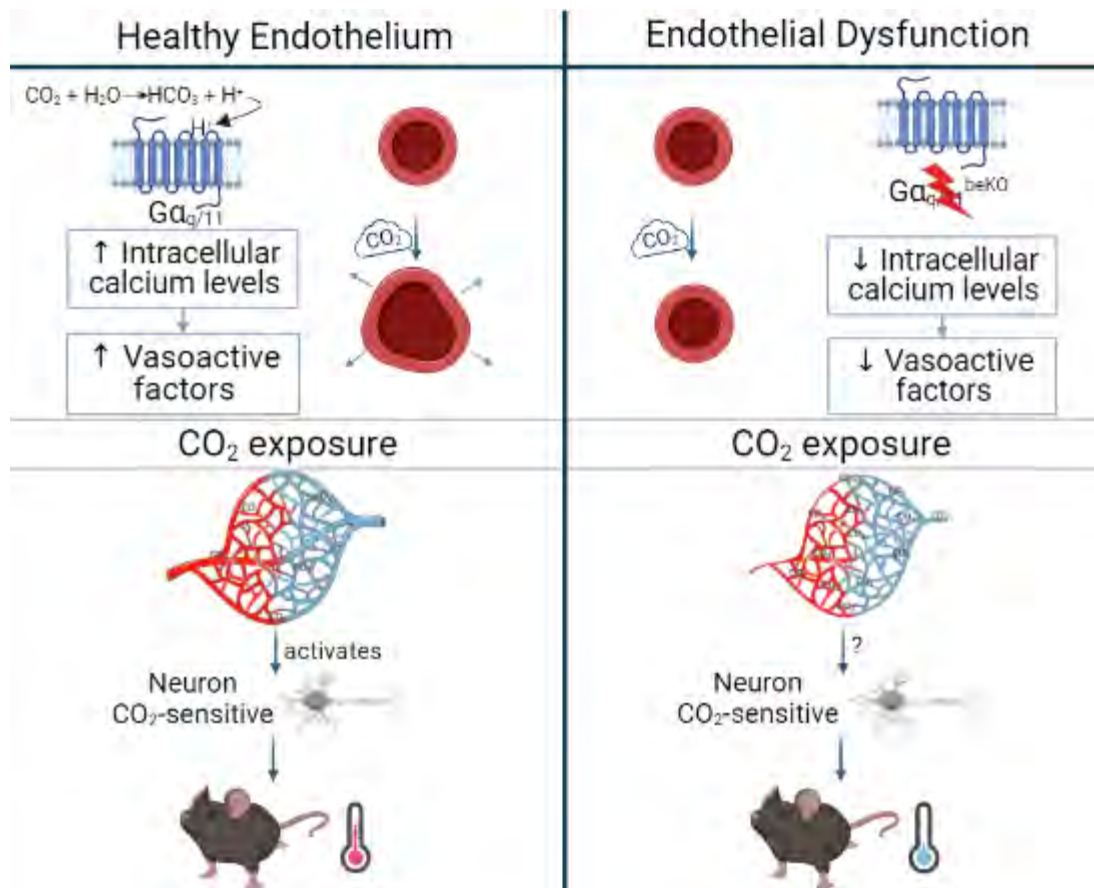

Stimulation of autophagy in hippocampal neurons by Neuropeptide Y

Ines Erdmann¹, Gina Marie Krause¹, Elisa Redavide^{1,2,4}, Anke Müller^{3,4}, Daniela C. Dieterich^{3,4}, Oliver Stork^{2,4}, Anne Albrecht^{1,4}

¹Institut für Anatomie, Neuroanatomie, Leipziger Str. 44, 39112 Magdeburg, Germany

²Institut für Biologie, Leipziger Str. 44, 39112 Magdeburg, Germany

³Institut für Pharmakologie und Toxikologie, Leipziger Str. 44, 39112 Magdeburg, Germany

⁴Centre for Behavioral Brain Research (CBBS), Magdeburg

Maintaining the proper function of each cell is pivotal to the survival of an organism. Thus, the proportion between newly synthesized molecules and the degradation of old or dysfunctional molecules needs to be tightly regulated within a cell. A typical degradation route within eukaryotic cells is called autophagy. Here macromolecules or even whole cell organelles are degraded and recycled. In neurons with their complex structure, architecture and function, autophagy plays an important role in protein homeostasis and organelles turn over in order to adapt to changing environmental conditions and maintain cellular homeostasis. The neuropeptide Y (NPY) is one of the most abundant neuropeptides within the brain and was recently found to induce autophagy in primary hypothalamic and cortical co-cultures. On the behavioral level, NPY is well known to regulate feeding via its hypothalamic subpopulation as well as anxiety and fear memory via NPY-positive hippocampal interneurons. Here, NPY is one of the most promising candidates to mediate stress resilience and reduce anxiety. Because of the high relevance for NPY as a potential candidate for the treatment of stress-induced neuropsychiatric disorders, we need to investigate its molecular functions within the hippocampus in more detail.

NPY treatment of neuronal primary cultures from the rat hippocampus induced autophagy for up to 24h, measured with western blot and immunocytochemistry for the marker LC3. While stimulation of hippocampal primary cultures in mice showed a different dynamic. Furthermore, in vivo injections of NPY into the mouse hippocampus increased LC3 levels in a circumscriptive hippocampal subregion and the hilus of the dentate gyrus (DG). This region contains NPY-positive interneurons, which demonstrated an activity-dependent regulation of LC3. Moreover, chemogenetic silencing of local NPY neurons in the DG regulated mossy fibre structure known as the projections from the DG to CA3 excitatory cells. Currently, we are investigating the NPY effects on autophagy and their possible link to the mossy fibre projections by using organotypic hippocampal slice cultures (OHSCs) from mice. First experiments showed an acute reduction of LC3 signal intensities that was restricted to the granular cell layer of the DG and the CA3 pyramidal cell layer.

Taken these findings together, NPY effects on autophagy in mice appear to be highly dynamic in the locally refined mossy fibre system and within NPY-positive interneurons. With regard to its anxiolytic and antidepressant effects, these cellular functions of NPY may help to refine novel targets for therapies against stress-induced neuropsychiatric disorders such as depression and post-traumatic stress disorders (PTSDs).

Tanycytic thyroid hormone (TH) signalling in the regulation of hypothalamic functions and hormone uptake

Akila Chandrasekar¹, Sebastain Abele¹, Anke Fähnrich², Frauke Spiecker¹, Jens Mittag³, Markus Schwaninger¹, Helge Müller-Fielitz¹

¹Institute of Experimental Pharmacology and Toxicology, University of Lübeck

²Lübeck Institute of Experimental Dermatology

³Institute of Endocrinology and Diabetes, University of Lübeck

Thyroid hormones (TH) play an important role in brain development, central nervous system functions and energy metabolism. In order to mediate these effects in the brain, TH are actively transported through the blood-brain barrier from the periphery to the brain. Tanycytes are specialized ependymal cells that line the wall and the base of the third ventricle in the mediobasal hypothalamus. The cell bodies are in contact with the cerebrospinal fluid and send their processes to hypothalamic nuclei (α tanycytes) and the fenestrated vessels (β tanycytes) in the median eminence (ME). Tanycytes projecting to the ME act as gatekeepers for the entry of peripheral substances (eg: leptin and ghrelin) and control hormonal release of hypophysiotropic hormones (eg: GnRH and TRH). They express the repertoire to transport and activate TH and respond to TH themselves. Our previous data suggested that TH modulates tanycytic functions and morphology, which in turn plays a role in the TH transport to the hypothalamus. However, the precise mechanism of how TH and their receptors modulate tanycytic functions is unclear. In this project we use specific genetic tools to manipulate the tanycytic TH transport as well as the tanycytic TH signalling pathway, to investigate the physiological relevance of the interaction between TH and tanycytes. We inhibit TH functions by overexpressing a dominant negative mutant of Thyroid hormone receptor α (TR α 1^{DN}) in tanycytes. We use qPCR and calcium imaging as tools to investigate the changes in the hormonal axes and gene expression on inhibiting TR α 1 specifically in tanycytes. We further probe into the possible metabolic changes in the mice by using indirect calorimetry. It has previously been shown that addition of the TRH analog taltirelin led to an increase in the size of the endfeet of tanycytes. To further understand the morphological changes of tanycytes due to TH, we performed scratch assays to track the migration patterns of primary tanycytes. Overall, we hypothesize that the modulation of the gatekeeper functions of tanycytes by inhibition of TR α 1 specifically in tanycytes and regulation of tanycytic endfeet morphology has an important impact on the central regulation of physiological functions and diseases. A better understanding of how local TH actions modulate tanycytic functions could provide the basis for an improved treatment opportunity of patients with central TH resistance.

Temperature-dependent variability of detectable neuropeptide titers in individual *Drosophila* neurons by quantitative immunolabelling

Inga Schirmer¹, Susanne Neupert¹

¹Universität Kassel, Animal Physiology, Heinrich-Plett-Straße 40, 34132 Kassel, Germany

Neuroactive substances like biogenic amines and neuropeptides play an essential role in the regulation of physiological processes and animal behaviors. Both are released from neurons and have highly diverse functions, structures and dynamic expression pattern in the nervous system. Physiological and behavioral experiments to understand their functional role within neuronal circuits often rely on animal immobilization by cooling; however, the influence of this intervention on the physiology of the organism remains largely unexplored for neuropeptides. In this study, we investigate cooling effects on individual corazonin (Crz)-expressing neurons of larval and adult fruit fly *Drosophila melanogaster* by quantitative immunocytochemistry. Corazonin and octopamine are involved in a variety of neuronal circuits regulating e.g. feeding, growth and stress responses. To uncover temperature-depending effects, we used two test groups: (1) uncooled animals, and (2) animals cooled for 60 min. As a marker we used a gfp-guided Tcd2-Gal4 fly strain and performed whole-mount immunofluorescence stainings against corazonin (Crz) on L3 larval CNSs and adult brains. Statistical comparison revealed higher signal intensities of Crz-ir larval neurons in cooled flies compared to uncooled. In addition, our preliminary data indicated also a difference in the soma size of the dorsolateral Crz-processing neurons which showed a larger volume in cooled animals compared to uncooled.

Our experiments suggest a non-negligible influence of the cooling time on the neuropeptide titers. Thus, this aspect should be strongly considered for experimental designs of future studies to investigate the functional role of these signaling molecules within neuronal circuits.

The role of BDNF^{LH} neurons in the regulation of feeding behaviour

Carolin Schumacher¹, Anne Petzold^{1,2}, Tatiana Korotkova^{1,2}

¹University of Cologne, Institute for Vegetative Physiology, Robert-Koch-Str. 39, 50931 Cologne, Germany

²Max Planck Institute for Metabolism Research, Gleueler Str. 50, 50931 Cologne, Germany

BDNF is a neurotrophin that has been shown to be involved in energy balance regulation in humans and rodents, through as yet unknown neural mechanisms. While the lateral hypothalamus (LH) is a major feeding regulatory centre and harbours a substantial population of BDNF⁺ neurons, the relevance of BDNF signalling within the LH for the regulation of feeding remains elusive.

To investigate whether the activity of BDNF^{LH} cells affects feeding behaviour, we selectively excited those cells in freely behaving mice using a chemogenetic activation. To do so, we expressed either hM3Gq -an excitatory DREADD – or a control construct in BDNF^{LH} cells of BDNF-Cre mice. During chemogenetic activation of BDNF^{LH} neurons, we measured food and water consumption and assessed feeding and exploration behaviour with automated video tracking.

Activation of BDNF^{LH} cells increased food and water intake six hours after CNO injection. Multi-day activation of BDNF^{LH} cells increased food intake over 24 h without increasing body weight compared to control group. Activation of BDNF^{LH} cells acutely suppressed the consumption of palatable, high fat food without affecting food intake over 24 h, body weight or glucose tolerance compared to control group. Activation of BDNF^{LH} cells acutely increased locomotion in the open field test, and decreased anxiety, assessed in the elevated plus maze. Thus, chemogenetic activation of BDNF^{LH} neurons acutely affected food and water intake, without shifting the homeostatic body weight setpoint. BDNF^{LH} neurons may regulate foraging behaviours by driving locomotion and suppressing anxiety.

The role of orexin receptors 1 and 2 in serotonergic neurons of raphe nuclei

Gagik Yeghiazaryan^{1,2}, Xing Xiao^{2,3}, Simon Hess^{1,2}, Paul Klemm³, Anna Sieben³, André Kleinridders³, Donald Morgan⁴, Thomas Wunderlich³, Kamal Rahmouni⁴, Dong Kong⁵, Thomas Scammell⁵, Bradford Lowell⁵, Jens Brüning³, Christine Hausen³, Peter Kloppenburg^{1,2}

¹ Biocenter, University of Cologne, Zùlpicher Strasse 47b, 50674 Cologne, Germany

² Excellence Cluster on Cellular Stress Responses in Aging Associated Diseases (CECAD) and Center for Molecular Medicine Cologne (CMMC), University of Cologne, Joseph-Stelzmann-Strasse 26, 50931 Cologne, Germany

³ Max Planck Institute for Metabolism Research, Gleueler Strasse 50, 50931 Cologne, Germany

⁴ University of Iowa, Carver College of Medicine, Iowa City, IA 52242, USA

⁵ Beth Israel Deaconess Medical Center and Harvard Medical School, 3 Blackfan Circle, Boston, MA 02215, USA

Obesity and type 2 diabetes mellitus represent a global burden affecting over a third of the world's population. However, the cellular mechanisms of these metabolic disorders are still poorly understood. Orexins (hypocretins) are neuropeptides expressed by distinct neurons in the lateral hypothalamic area (LHA) and adjacent regions. The orexin system consists of two distinct neuropeptides, orexin-A and orexin-B (hypocretin-1 and -2), which are both derived from a common precursor peptide, and they act on two G-protein coupled receptors: orexin receptor type 1 (Ox1R) and type 2 (Ox2R). The wake-active orexin system plays a key role in maintaining dynamic regulation and the daily rhythm of peripheral glucose homeostasis. It regulates blood glucose, possibly through the autonomic nervous system. To better understand the role of orexin receptors in the serotonergic raphe nuclei in energy homeostasis, we systematically investigated the expression and distribution of orexin receptors in serotonergic neurons in the raphe nucleus. Next, we generated mouse lines lacking either Ox1R or Ox2R in serotonergic cells via the Cre/LoxP system and studied the insulin sensitivity of these mice in diet-induced obesity. Last but not least, we investigated the impact of optogenetic activation of orexin signaling and specific inactivation of Ox1R or Ox2R signaling in serotonin transporter (Sert)-expressing cells on glucose metabolism. Collectively, the present study assigns orexin signaling in serotonergic neurons critical yet differential orexin Ox1R and Ox2R-dependent functions in regulating systemic glucose homeostasis.

The Role of TRH Neurons in Energy Homeostasis and Regulation of Brown Adipose Tissue

Andreea Constantinescu¹, Luka Höhne¹, Jens Mittag², Helge Müller-Fielitz¹, Markus Schwaninger¹

¹Universität zu Lübeck, Inst. f. experimentelle u. klin. Pharmakologie und Toxikologie, Alfstrasse, 35, 23552 Lübeck, Germany

² Universität zu Lübeck, Inst.f. Endokrinologie u. Diabetes

AIM

Neurons containing thyrotropin releasing hormone (TRH) in the paraventricular hypothalamus (PVH), are cell populations best known for their role in regulating the hypothalamic-pituitary-thyroid (HPT) axis. Nevertheless, there are multiple TRH expressing populations throughout the brain, including in areas known for their role in temperature homeostasis and metabolic control. Here we focus on the effect of TRH neurons in the PVH, dorsomedial hypothalamus (DMH) and medial preoptic area (MPA) on brown adipose tissue (BAT) thermogenesis, food intake, and energy expenditure, by using a strategy involving transgenic mice and AAV-based chemogenetic tools in combination with calorimetric measurements. Furthermore, we set out to describe possible alternative pathways for PVH residing TRH neurons that diverges from the classical neuroendocrine function of these cells. Using TRHR1^{-/-}/Thr^{cre+} and TRHR2^{-/-}/Thr^{cre+} mice, we show that some of the metabolic effects observed during TRH neuron stimulation in the PVH are independent of the activation of the HPT axis.

RESULTS

Stimulation of PVN TRH neurons led to an increase in energy expenditure (EE), respiratory exchange rate (RER), body temperature and BAT temperature as well as an increased feeding behavior. These effects were accompanied by an increase in thyroid hormone T3 and T4 levels in the plasma. Unexpectedly, the absence of the TRHR1 did not change the effect of PVN TRH stimulation on parameters such as RER, EE and feeding. However, TRHR2 inactivation reduces the increase of EE. Interestingly stimulation of the DMH population led to a similar phenotype but no increase in T4 levels. MPA stimulation on the other hand did not result in BAT driven thermogenesis despite increased RER and EE levels, it also did not change thyroid hormone concentrations in the plasma.

CONCLUSION

Our data show a differential effect of TRH neurons in the PVH, DMH and MPA on BAT activation and thermogenesis. Simultaneously we uncover joined action of different TRH expressing populations in terms of RER and food intake. Thus, we confirm that TRH neuronal signaling plays a pivotal role in the regulation of calorie intake and subsequent energy expenditure that is not confined to PVH action.

Furthermore, our findings show that these effects are partially separable from the action of TRH receptors and the HPT axis. Taken together, our data highlight the importance of different populations of TRH neurons and propose a system of different connections circumventing the established neuroendocrine pathway.

3-D STED Imaging of Tanycytes

Surya Prakash Rai¹, Helge Müller-Fielitz¹, Markus Schwaninger¹

¹University of Lubeck, Institut für Experimentelle und Klinische Pharmakologie und Toxikologie, Ratzeburger Allee 160, 23562 Lubeck, Germany

The hypothalamus regulates the function of the pituitary gland and controls various hormonal axes. Neurons of the hypothalamus produce release hormones, eg. gonadotropin releasing hormone (GnRH) and thyrotropin releasing hormone (TRH). The secretion of GnRH and TRH into the portal vessels is modulated via tanycytes.

As specialized glial cells located in the walls of the third ventricle, tanycytes send long cell protrusions to the portal vessels. The end-feet of the tanycytes surround the blood vessels in the eminentia mediana. It has been suggested that the tanycytic end-feet control the secretion of GnRH and TRH into the portal vessels.

Previously, it has been shown that the size of tanycytic end-feet is altered by TRH analogues such as taltirelin indicating that end-feet are dynamic structures. However, the visualisation was then performed with confocal microscopy which was faced by the resolution limit of light microscopy.

In this study, we studied the morphology of tanycytes using a custom-built STED microscope (Abberior GmbH) which allowed us to visualise the tanycytic end-feet at super-resolution scale. Labelling of individual tanycytes was achieved by AAV-Cre-mediated GFP expression in the R26-mTmG mouse line. Later, the PFA-fixed sections were immunofluorescently stained and the STED microscope was used to visualise the tanycytic cell body and tanycytic end-feet. The images suggest that the multiple processes and end-feet of tanycytes interact to form a 3D barrier structure (Fig. 1).

Ongoing work is characterizing the 3D morphology of tanycytic end-feet in further details. In summary, 3D-STED imaging proves to be a powerful technique to investigate tanycytic cell morphology.

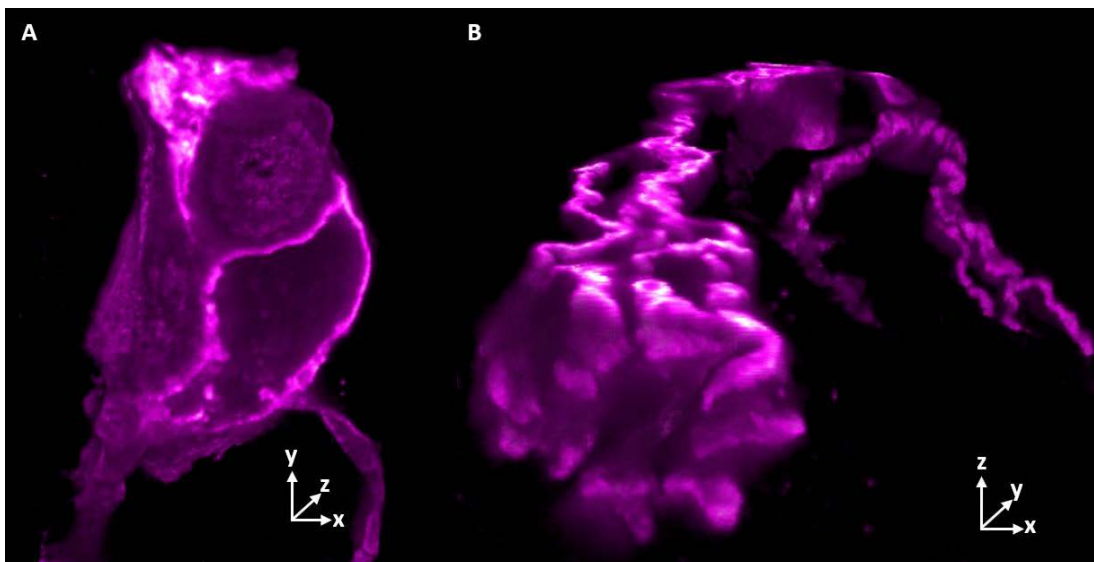

Fig. 1 Three-dimensional STED imaging and volume rendering of the tanycyte. A 4- μ m thick

volumetric recording of A. tanycytic cell body and B. tanycytic end-feet labelled with GFP was performed in 3D-STED mode (xyz pixel size: 50 X 50 X 50 nm). Later, the volume rendering was performed in Fiji using 3D Viewer.

Sleep deprivation increases performance in larval zebrafish decision making

Hanna Zwaka¹, Paula Pflitsch¹, Will Joo¹, Kumaresh Krishnan¹, Nadine Oury¹, Armin Bahl², Declan Lyons³, Jason Rihel³, Florian Engert¹

¹Harvard University, Molecular and Cellular Biology

²Konstanz University

³UCL London

Humans and most animals need sleep to function well. Lack of sleep has a multitude of effects on the brain and the body including a decrease of cognitive and physical performance. Zebrafish are a popular model to study sleep. Here we set out to investigate the effects of sleep deprivation on innate behaviors and simple cognition in larval zebrafish. We show that in zebrafish larvae sleep deprivation downregulates bouting the day after sleep deprivation but does not compromise visual-motor integration. In contrast to expectation, sleep-deprived larvae that are faced with a random-dot motion discrimination task perform better than a well-rested control. Previous work has demonstrated that zebrafish larvae accumulate motion evidence over time and their resulting decision can be explained with a bounded leaky integrator model. We hypothesize that the reduced bouting gives them more time to integrate the random-dot-motion and hence leads to an increased performance. Finally, we artificially reduce bouting in zebrafish larvae using the drug melatonin and show that the decrease bouting in fact leads to an increased performance. Our results provide new findings on the effects of sleep deprivation on innate behaviors in larval zebrafish and pave the way for a more conclusive understanding of the alterations sleep deprivation leaves behind on body and brain.

Transgenerational effects of early life stress on DNA methylation of the Oxytocin receptor promoter (OxtR) in mouse brain and peripheral tissues.

Brigid Chimoita Aliero¹, Nicole Gröger¹, Alexandra Lesse¹, Kathrina Braun^{1,3}, Jörg Bock^{2,3}

¹ Department of Zoology and Developmental Neurobiology, Institute of Biology, Otto-von-Guericke University Magdeburg, Leipziger Str.44, 39120 Magdeburg, Germany

² PG "Epigenetics and Structural Plasticity", Institute of Biology, Otto-von-Guericke University Magdeburg, Leipziger Str.44, 39120 Magdeburg, Germany

³ Center for Behavioral Brain Sciences CBBS, Magdeburg, Germany

Transgenerational inheritance of neuropsychiatric disorders has been linked to early life stress (ELS)-induced epigenetic programming. However, mechanisms describing if this programming occurs via behavioral or germ-line routes remain unresolved. Our earlier work showed that chronic postnatal stress (CS; maternal separation combined with subsequent social isolation) resulted in altered inverse OxtR gene expression in the hippocampus of the female mice, there was an increased expression of OxtR in F0 generation, a decrease in F1 and an increased expression in the F2 offspring. The altered OxtR expression indicated that the function of the oxytocinergic system, a key behavioral modulator, may be permanently modified. Based on these findings we addressed the hypotheses that i) the observed gene expression changes in the brain are epigenetically mediated via DNA-methylation at the OxtR promoter, ii) comparable epigenetic marks can also be detected in the female germ line and in the blood, and iii) these epigenetic marks are transgenerationally transmitted to F1 and F2 generation offspring of female C57BL/6J mice. Using pyrosequencing we detected a number of CS-induced CpG-site-specific changes in OxtR methylation in the hippocampus, prefrontal cortex, whole blood and ovary tissue compared to controls. Patterns of DNA-methylation across the analysed 43 CpG sites were comparable in all tissues and across all generations. We also found a strong positive correlation of DNA-methylation at specific, individual CpG positions between ovaries and prefrontal cortex as well as between hippocampus and blood in all generations. Significant CS-induced changes of mean DNA-methylation at the analysed CpG-sites in ovaries were found in F0, F1 and F2 generation. These findings indicate a transgenerational transmission of the CS-induced epigenetic marks via the female germline, contributing to the observed brain-specific alterations in OxtR-expression.

Complementary lateral hypothalamic populations resist hunger pressure to balance nutritional and social needs

Anne Petzold^{1,2}, Hanna Elin van den Munkhof^{1,2}, Rebecca Figge-Schlensok^{1,2}, Tatiana Korotkova^{1,2}

¹University of Cologne, Institute for Vegetative Physiology, Robert-Koch-Str. 39, 50931 Cologne, Germany

²Max Planck Institute for Metabolism Research, Gleueler Str. 50, 50931 Cologne, Germany

Animals continuously weigh nutritional needs against competing drives such as mating according to state and opportunity. However, the neuronal mechanisms of sensing and resisting metabolic pressure such as hunger or thirst remain poorly understood. The lateral hypothalamus (LH) regulates feeding and drinking, in part through leptin receptor-expressing (LepR^{LH}) and neurotensin-expressing (Nts^{LH}) neurons. In this study, we show how these neural populations enable resistance to metabolic deprivation to enable behavioural flexibility.

Using single-cell, deep-brain Ca²⁺ imaging in freely moving animals, we found that LepR^{LH} neurons encoded food stimuli, whereby the magnitude of food-elicited responses increased with food intake. Failure to resist moderate hunger pressure was encoded by escalating inhibition of a leptin-sensitive LepR^{LH} subpopulation at a fast time scale. Similarly, LepR^{LH} neurons of thirsty animals encoded water stimuli. Optogenetic activation of LepR^{LH} neurons suppressed food or water intake in moderately hungry or thirsty animals. Importantly, LepR^{LH} neurons preferentially encoded potential mating partners, and promoted the sex-specific exploration of social stimuli.

Conversely, hunger pressure intensified water encoding of Nts^{LH} neurons, whereby the magnitude of water-elicited responses reflected food intake. Detailed behavioural analysis revealed that Nts^{LH} neurons track food intake to scale water intake accordingly, ensuring the balance between feeding and drinking, and discounted social interaction.

In summary, hunger pressure gates LepR^{LH} and Nts^{LH} populations in a complementary manner to enable the flexible fulfilment of competing essential needs against hunger pressure.

We gratefully acknowledge support by the ERC Consolidator Grant (772994, FeedHypNet, to T.K.) and DFG (Project-ID 431549029 – SFB 1451, to T.K., EXC2030 CECAD, to T.K., 233886668-GRK1960, to R.F.).

A role of the oxytocin signaling in the hypothalamus for social fear learning

Takuya Osakada¹, Yiwen Jiang¹, Rongzhen Yan¹, Rina Tabuchi¹, Dayu Lin¹

¹New York University Langone Medical Center, Neuroscience Institute, 435 East 30th Street, Science Building, 1323S, 10016 New York, USA

Many animals live in complex social groups. To survive, it is essential to know who to avoid and who to interact. Although naïve mice are naturally attracted to any adult conspecifics, a single defeat experience could elicit social avoidance towards the aggressor for days. The neural mechanisms underlying the behavior switch from social approach to social avoidance remains incompletely understood. Here, we identify oxytocin neurons in the retrochiasmatic supraoptic nucleus (SOR^{OXT}) and oxytocin receptor (OXTR) expressing cells in the anterior subdivision of ventromedial hypothalamus, ventrolateral part ($aVMHvl^{OXTR}$) as a key circuit motif for defeat-induced social avoidance learning. After defeat, $aVMHvl^{OXTR}$ cells drastically increase their responses to aggressor cues. This response change is functionally important as optogenetic activation of $aVMHvl^{OXTR}$ cells elicits time-locked social avoidance towards a benign social target whereas inactivating the cells suppresses defeat-induced social avoidance. Furthermore, OXTR in the $aVMHvl$ is itself essential for the behavior change. Knocking out OXTR in the $aVMHvl$ or antagonizing the receptor during defeat, but not during post-defeat social interaction, impairs defeat-induced social avoidance. $aVMHvl^{OXTR}$ receives its private supply of oxytocin from SOR^{OXT} cells. SOR^{OXT} is highly activated by the noxious somatosensory inputs associated with defeat. Oxytocin released from SOR^{OXT} depolarizes $aVMHvl^{OXTR}$ cells and facilitates their synaptic potentiation, and hence, increases $aVMHvl^{OXTR}$ cell responses to aggressor cues. Ablating SOR^{OXT} cells impairs defeat-induced social avoidance learning whereas activating the cells promotes social avoidance after a subthreshold defeat experience. Altogether, our study reveals an essential role of SOR^{OXT} - $aVMHvl^{OXTR}$ circuit in defeat-induced social learning and highlights the importance of hypothalamic oxytocin system in social ranking and its plasticity.

Poster Topic

T23: Neural Networks and Rhythm Generators

- [T23-1A](#) A galanin-positive population of lumbar spinal cord neurons modulates sexual behavior and arousal
Constanze Lenschow, Ana Rita P. Mendes, Liliana Ferreira, Bertrand Lacoste, Camille Quilgars, Sandrine S. Bertrand, Susana Q. Lima
- [T23-2A](#) A Systematic Classification of Neurons forming the Clamp Region in the Adult *Drosophila* Brain
Jonas Mario Klußmann, Jens Goldammer, Kei Ito
- [T23-3A](#) Anatomical connections of the crow brain's cognitive control center nidopallium caudolaterale (NCL)
Saskia Erdle, Ylva Kersten, Felix W. Moll, Andreas Nieder
- [T23-4A](#) Balanced ring network of spiking neurons as a model of visual cortex hypercolumn
Mohammadreza Soltanipour, Fred Wolf
- [T23-5A](#) Behavioral state-dependent modulation of Insulin-Producing Cells in *Drosophila*
Sander Liessem, Martina Held, Rituja Bisen, Hannah Haberkern, Haluk Lacin, Till Bockemühl, Jan M. Ache
- [T23-6A](#) Biological validation of a microneedle 3D high-density CMOS multi-electrode array for brain tissue and spheroids
Elisa Monz, Lisa Mapelli, Olivier Dubochet, Mariateresa Tedesco, Giacomo Sciacca, Alessandra Ottaviani, Anita Monteverdi, Chiara Battaglia, Simona Tritto, Francis Cardot, Patrick Surbled, Jan Schildknecht, Chiara Cervetto, Manuela Marcoli, Egidio D'Angelo
- [T23-7A](#) Characterization of circadian modulators in relay stations of prefrontal-to-hippocampal circuits via viral tracing and laser microdissection
Lara Mariel Chirich Barreira, Julia U. Henschke, Janelle M.P. Pakan, Anne Albrecht
- [T23-8A](#) Connectivity Analysis of the Monoaminergic Systems of *Drosophila* Brain
Jiajun Zhang, Nikolaj Rieger, Kei Ito, Thomas Riemensperger
- [T23-9A](#) Consequences of Axonal Dysfunctions for Network Oscillations in a Mouse Model of Dravet Syndrome
Raquel Lascorz Massanet, Fabian C. Roth

- [T23-10A](#) DEND mutation disrupts hippocampal network activity and nocturnal γ shifts
Kristina Lippmann, Marie-Elisabeth Burkart, Josephine Kurzke, Jorge Vera, Frances Ashcroft, Jens Eilers
- [T23-1B](#) Dendritic axon origin enables selective information gating by perisomatic inhibition in pyramidal neurons
Martin Both, Alexander Hodapp, Martin E Kaiser, Christian Thome, Lingjun Ding, Andrei Rozov, Matthias Klumpp, Nikolas Stevens, Tina Sackmann, Nadja Lehmann, Andreas Draguhn, Andrea Burgalossi, Maren Engelhardt
- [T23-2B](#) Developmental network embedding of PV interneurons in relation to the emergence of gamma rhythms in the prefrontal cortex
Anton Offermanns, Jastyn A. Pöppelau, Ileana Hanganu-Opatz
- [T23-3B](#) Different involvement of axon-carrying dendrite versus canonical neurons during learning processes
Nadja Sharkov, Matthias Klumpp, Nikolas Stevens, Christian Thome, Janina Kupke, Andreas Draguhn, Ana M. M. Oliveira, Martin Both
- [T23-4B](#) Disinhibitory Circuit Motifs in Mouse Primary Somatosensory (Barrel) Cortex
Felix Preuß, Martin Möck, Mirko Witte, Jochen F. Staiger
- [T23-5B](#) Dynamics in timing of the sounds of *Mecopoda elongata*
Reinhard Lakes-Harlan
- [T23-6B](#) Electrophysiological Characterization and Computational Modeling of Insulin-Producing Cells in *Drosophila*
Federico Cascino-Milani, Lorenzo Fontolan, Sabine Fischer, Jan M. Ache
- [T23-7B](#) Functional Analysis of Neuropeptides in the Accessory Medulla of the Madeira Cockroach *Rhyarobia maderae*
Sohail H. Shoaib, Susanne Neupert, Monika Stengl
- [T23-8B](#) Functional characterization of long-range GABAergic projections from the medial septum to the lateral entorhinal cortex
Viktoria B. Pfennig, Yu-Chao Liu, Elke C. Fuchs, Hannah Monyer
- [T23-9B](#) Higher-order anatomical connectivity explains functional properties of visual circuitry
Juan Felipe Vargas Fique, Sebastian Molina-Obando, Marion Silies
- [T23-10B](#) Investigating the coupling between surplus spike synchrony and slow oscillations in the dorsal hippocampus
Regimantas Jurkus, Julien Fiorilli, Thijs R. Ruikes, Sonja Grün, Cyriel M. A. Pennartz, Michael Denker
- [T23-1C](#) Investigation of the involvement of pigment-dispersing factor (PDF) and other neuropeptides in seasonal adaptation to the changing photoperiod in the cockroach *Rhyarobia maderae*

Huleg Zolmon, Susanne Jaguttis, Monika Stengl

- [T23-2C](#) Ionic currents in insect circadian clock neurons
Anna C. Schneider, Monika Stengl
- [T23-3C](#) Late developmental dynamics of activity patterns within prefrontal-hippocampal networks in health and a genetic risk model for schizophrenia
Marilena Hnida, Jastyn A. Pöpplau, Ileana L. Hanganu-Opatz
- [T23-4C](#) Near-optimal encoding of minimal stimuli in the cortical gateway for somatosensation
Andreas Neef, Fred Wolf, Michael J Gutnick, Omer Revah
- [T23-5C](#) Network synchrony creates neural filters that switch brain state from navigation to sleep in *Drosophila*
Raquel Suárez Grimalt, Davide Raccuglia, Laura Krumm, Cedric C. Brodersen, Anatoli Ender, Sridhar Jagannathan, York Winter, Genevieve Yvon-Durocher, Richard Kempter, Jörg R.P. Geiger, David Oswald
- [T23-6C](#) Neural integration of sensory input and sleep need in *Drosophila*
Cedric Beat Brodersen, Raquel Suárez-Grimalt, Jörg RP Geiger, David Oswald, Davide Raccuglia
- [T23-7C](#) Olfactory dysfunction contributes to impaired developmental hippocampal-prefrontal activity in a mouse model of neuropsychiatric disorders
Fiona Parbst, Sebastian H. Bitzenhofer, Ileana L. Hanganu-Opatz
- [T23-8C](#) Peptidergic and aminergic modulation of Insulin-Producing Cells in *Drosophila*
Martina Held, Isabella Balles, Rituja Bisen, Selina Hilpert, Alexander S. Chockley, Federico Cascino-Milani, Sander Liessem, Meet Zandawala, Jan M. Ache
- [T23-9C](#) Syntalos: A Software for simultaneous acquisition of heterogeneous neurophysiological data and for closed-loop intervention protocols
Matthias Klumpp, Lee Embray, Justus Simon, Andreas Draguhn, Martin Both
- [T23-10C](#) The anatomy of auditory brainstem nuclei in the Etruscan shrew
Alina C. Zacher, Felix Felmy

A galanin-positive population of lumbar spinal cord neurons modulates sexual behavior and arousal

Constanze Lenschow^{1,2}, Ana Rita P. Mendes², Liliana Ferreira², Bertrand Lacoste²,
Camille Quilgars³, Sandrine S. Bertrand³, Susana Q. Lima²

¹Otto-von-Guericke Universität Magdeburg, Institute of Biology, Biology of Neural Circuits, Leipziger Straße 44, Haus 91, 39120 Magdeburg, Germany

²Champalimaud Neuroscience Programme; Champalimaud Foundation, Av. Brasília, Doca de Pedrouços, 1400-038 Lisbon, Portugal.

³INCLIA, Université de Bordeaux, CNRS UMR5287, 33076 Bordeaux, France.

During sex, male arousal increases up to the ejaculatory threshold, allowing genital sensory input to trigger ejaculation. While copulation and arousal increase are thought to be centrally regulated, ejaculation is a reflex controlled by a spinal circuit, whose activity is strongly inhibited by descending input from the brain, bearing no role on the regulation of sexual behavior up until the arousal threshold. However, this hypothesis remains untested. To tackle this problem, we combined genetic approaches with electrophysiological and behavioral analysis to functionally map the spinal circuit controlling the main muscle involved in sperm expulsion, the bulbospongiosus muscle (BSM). We found that BSM motor neurons (BSM-MNs) receive direct synaptic input from a group of galanin-expressing (Gal+) interneurons located in the upper lumbar spinal cord. Furthermore, the Gal+ population is progressively activated during sexual behavior and receives genital sensory input. Electrical and optogenetic activation of the Gal+ neurons evoked activity in BSM-MNs and BSM after spinalization. Interestingly, these effects were dependent on the behavioral state of the male and drastically decreased with repeated stimulation. Moreover, genetic ablation of the Gal+ neurons severely impacted the latency to ejaculate and the structure of the copulatory sequence. Taken together, our results imply an unexpected involvement of the spinal cord in the control of copulatory behavior, sexual arousal and in the post-ejaculatory refractory period, in addition to its well established role in ejaculation.

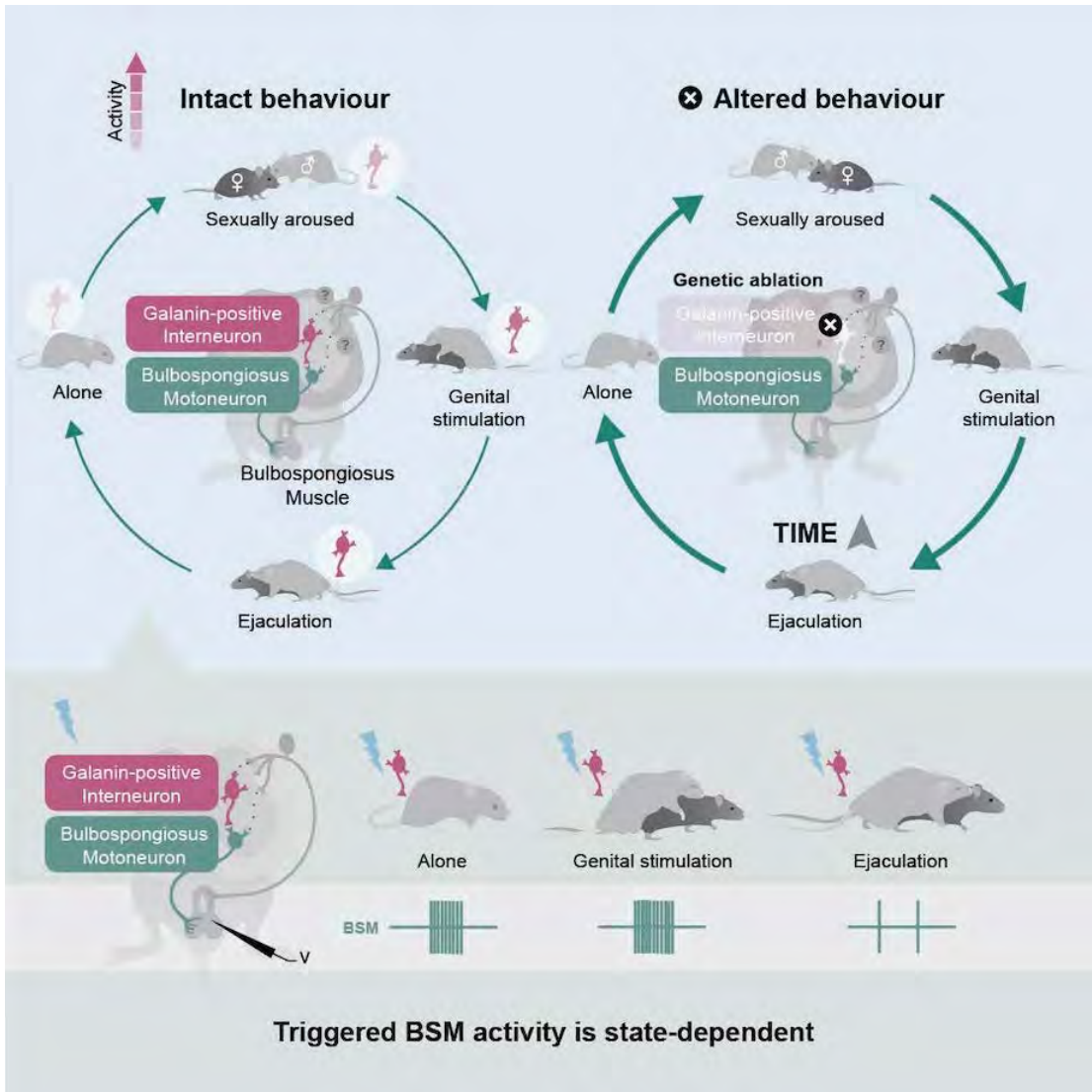

Graphical abstract

A Systematic Classification of Neurons forming the Clamp Region in the Adult *Drosophila* Brain

Jonas Mario Klußmann¹, Jens Goldammer¹, Kei Ito¹

¹University Cologne, AG Ito - Zoological Institute - Biocenter, Zùlpicher Str. 47b, 50674 Köln, Germany

The fruit fly *Drosophila melanogaster* represents a popular model organism that has been the subject of many studies trying to elucidate how the brain integrates sensory input and provides appropriate motor output. However, many studies are confined to a few, well investigated brain regions. In order to understand the neuronal circuits underlying computation that takes place on the scale of the entire brain, the so far unknown brain regions need to be investigated. One of these yet uncharacterized regions in the so to say “terra incognita” of the brain is the clamp region, which is located between the central complex and the mushroom body pedunculus. Despite of its location, the clamp region forms hardly any connections with these extensively studied centers and has completely unknown circuitry and potential function.

In order to reconstruct a neuronal circuit map of the clamp region we use the “hemibrain” electron microscopy connectome data generated at the HHMI Janelia Research Campus in collaboration with Google. In this dataset 746 neurons have been associated primarily to the clamp region, because they have the most extensive arborization there. These neurons were grouped into 346 types according to their near-identical projection and connectivity patterns. To further categorize these neurons in a logical and hierarchical manner, we compared several sorting criteria. The categorization based on the projection patterns within the clamp region yielded the most adequate hierarchical classification. Several neurons types that have a similar morphology and share the same cell lineage were first grouped into “families”, families with similar projection patterns in the clamp region are grouped into “orders” and orders that share certain local features are grouped into “classes”. Neurons that belong to the same class tend to form localized arborizations in different parts of the clamp forming certain levels of compartmentalization.

Many neurons that primarily project to neighboring brain regions also send their arborizations into the clamp. Those clamp-associated neurons were also classified further expanding the classification framework we have established. Our neuron catalogue and its grouping will form the basis for the first description of the connectome of clamp neurons, adding a piece to the map of the *Drosophila* brain and give insights into their possible functions.

Anatomical connections of the crow brain's cognitive control center nidopallium caudolaterale (NCL)

Saskia Erdle¹, Ylva Kersten¹, Felix W. Moll¹, Andreas Nieder¹

¹University of Tübingen, Animal Physiology, Institute of Neurobiology, Auf der Morgenstelle 28, 72076 Tübingen, Germany

The nidopallium caudolaterale (NCL) is the avian analog of the mammalian prefrontal cortex. A growing body of work has demonstrated that neurons in the dorsal NCL (NCLd) can encode abstract concepts and decisions as well as planned actions in carrion crows (*Corvus corone*, songbird). However, the direct inputs and outputs of NCLd have not been mapped comprehensively in songbirds. Here we explored the connections of the corvid NCLd with other brain regions and asked whether the connections of the crow NCLd are conserved when compared to a non-songbird (pigeon). Additionally, a recent study has suggested a split of the songbird NCL into three distinct subregions (dorsal, medial and ventral NCL), which has led to the hypothesis that these three brain areas could be significantly interconnected. To address these questions, we injected retrograde (choleratoxin) and anterograde (dextran) tracers into the NCLd of the carrion crow. Those fluorophore coupled dyes revealed direct, monosynaptic inputs into and axonal projections from NCLd. We found that the connections of the crow NCLd were highly conserved when compared to the NCL of the pigeon. Surprisingly, the medial and ventral NCL were only sparsely connected with the NCLd. Taken together, the connections of the crow NCLd reveal a multimodal structure with direct access to the motor system, rendering it as a prime structure for executive function.

Balanced ring network of spiking neurons as a model of visual cortex hypercolumn

Mohammadreza Soltanipour^{1,2,3}, Fred Wolf^{1,2,3}

¹Göttingen Campus Institute for Dynamics of Biological Networks, Göttingen, Germany

²Max Planck Institute for Dynamics and Self-Organization, Göttingen, Germany

³Berstein Center for Computational Neuroscience, Göttingen University, Göttingen, Germany

A large body of experimental studies have shown that cortical networks are operating in a fluctuation driven regime where the mean input to each neuron remains below threshold. Classical models of balanced networks in which the strong recurrent inhibition “balances” the excitatory drive can robustly reproduce such behavior [1]. It has been reported that networks of orientation tuned neurons in the balanced state can sharpen output relative to input tuning [2,3]. These mechanisms of response sharpening are distinct from amplification-based sharpening and does not rely on nonlinear mechanisms and closeness to a transition to spontaneous symmetry breaking [4,5]. So far, no analytically solvable model for balanced cortical response sharpening was known. Here we present a model and method to analytically obtain the complete population tuning profile for a general balanced state network of ring architecture.

As a model of a visual cortex orientation hypercolumn we examine a ring network of excitatory and inhibitory spiking neuron models. Individual neurons receive a total afferent input that is maximal at a particular stimulus orientation, which depends on their position on the ring. The connection probabilities are orientation specific follow a von Mises distribution in angle difference. The orientation dependence of the tuned afferent input is also assumed to follow a von Mises function. Using a mean field theory in the large system limit, we analytically obtained the exact balanced solution for the firing rate profiles of the network as a series of Bessel functions. This solution is independent of the details of the single neuron model and directly follows from the current balance equation. Depending on concentration of the connection probability, the model accounts for the entire spectrum of networks from a randomly connected network to a highly selective connectivity. Using numerical simulations, we validate the analytical solution and observe heterogeneity of tuning curves in individual neurons. Moreover, we find that while the tuning of the population response profile is contrast invariant, individual neurons exhibit contrast-dependent orientation tuning comparable to recent experimental reports.

References

- [1] Wolf, Fred, et al. "Dynamical models of cortical circuits." *Current opinion in neurobiology* 25 (2014): 228-236.
- [2] Van Vreeswijk, C., and H. Sompolinsky. "Irregular activity in large networks of neurons." *Les Houches*. Vol. 80. Elsevier, 2005. 341-406.
- [3] Rosenbaum, Robert, and Brent Doiron. "Balanced networks of spiking neurons with spatially dependent recurrent connections." *Physical Review X* 4.2 (2014): 021039.
- [4] Ben-Yishai, Rani, R. Lev Bar-Or, and Haim Sompolinsky. "Theory of orientation tuning in visual cortex."

Proceedings of the National Academy of Sciences 92.9 (1995): 3844-3848.

Douglas, Rodney J., et al. "Recurrent excitation in neocortical circuits." *Science* 269.5226 (1995): 981-985.

Behavioral state-dependent modulation of Insulin-Producing Cells in *Drosophila*

Sander Liessem¹, Martina Held¹, Rituja Bisen¹, Hannah Haberkern², Haluk Lacin³, Till Bockemühl⁴, Jan M. Ache¹

¹Neurobiology and Genetics, Theodor-Boveri-Institute, Biocenter, Julius-Maximilians-University of Würzburg, Würzburg, 97074, Germany

²HHMI Janelia Research Campus, Ashburn, VA 20147, US

³Department of Genetics, Washington University in St Louis, St. Louis, MO 63130, US

⁴Department of Biology, Institute of Zoology, University of Cologne, Cologne, 50674, Germany

Insulin plays a pivotal role in metabolic control, neuromodulation, and aging, but its release dynamics are not well understood. We used *Drosophila melanogaster* to study effects of locomotion on the activity of Insulin-Producing Cells (IPCs). Using a combination of *in-vivo* patch-clamp recordings, calcium imaging, and optogenetics, we found that IPCs were inhibited during walking and flight. This modulation was graded, such that the inhibition was stronger during flight – the more energy-demanding behavior. A resulting decrease in insulin levels would support the mobilization of fuel stores and the suppression of anabolic processes during locomotion. IPC activity was increased immediately after cessation of locomotion. This rebound could contribute to replenishing muscle glycogen stores. Surprisingly, IPC modulation preceded the onset of locomotion, suggesting a feedforward mechanism impinging on IPCs. This was further supported by *ex-vivo* recordings combined with optogenetic activation of motor circuits, which revealed that IPC inhibition neither requires actual behavior, nor decreased blood sugar levels – a simple motor command was sufficient to inhibit IPCs. In a nutshell, we add the behavioral state to the list of factors regulating IPC activity in *Drosophila*. These rapid changes in IPC activity precede locomotion and may serve an increased metabolic demand. Moreover, high insulin levels are known to decrease the sensitivity of olfactory sensory neurons in flies. Hence, the inhibition of IPCs could lead to a disinhibition of olfactory sensory neurons, which could increase the likelihood of locating food sources during locomotion. Thus, behavioral state-dependent IPC modulation might enable differential sensorimotor processing.

Biological validation of a microneedle 3D high-density CMOS multi-electrode array for brain tissue and spheroids

Elisa Monz¹, Lisa Mapelli², Olivier Dubochet³, Mariateresa Tedesco¹, Giacomo Sciacca¹,
Alessandra Ottaviani², Anita Monteverdi^{2,4}, Chiara Battaglia¹, Simona Tritto², Francis
Cardot³, Patrick Surbled³, Jan Schildknecht³, Chiara Cervetto^{5,6}, Manuela Marcoli^{5,6,7},
Egidio D'Angelo^{2,4}

¹Brain AG, Huobststrasse 16, 8808 Pfäffikon SZ, Switzerland

²Department of Brain and Behavioral Sciences, University of Pavia, Pavia, Italy

³Centre Suisse d'Electronique et de Microtechnique (CSEM), Neuchâtel, Switzerland

⁴Brain Connectivity Center, IRCCS Mondino Foundation, Pavia, Italy

⁵Dept of Pharmacology (DIFAR), University of Genoa, Genoa, Italy

⁶Interuniversity Center for the Promotion of the 3Rs Principles in Teaching and Research (Centro 3R), Italy

⁷Center of Excellence for Biomedical Research, Genoa, Italy

In recent years, planar multi-electrode arrays (MEAs) have been widely used to record activity from in vitro neuronal cell cultures and tissue slices. However, when this technique is applied to a 3 dimensional structure, it bears several limitations that result in a reduced quality of the information collected, limited interpretation of the results in terms of network functions, and impaired vitality of the tissue analyzed. To overcome these problems, we empowered a CMOS high-density multi-electrode array (HD-MEA) with thousands of microneedles (μ needles) of 65-90 μ m height, able to penetrate and record in-tissue signals, providing for the first time a 3D HD-MEA chip. For biological validation, we used cerebellar and cortico-hippocampal slices as an ex vivo 3D tissue model and brain spheroids as in vitro 3D cellular model. In both cases we demonstrated that the μ needles efficiently penetrate the tissue while the microchannels allow the flowing of maintenance solutions to increase tissue vitality in the recording sites. These improvements are reflected by the increase in electrodes sensing capabilities, the number of sampled neuronal units (compared to matched planar technology), and the efficiency of compound effects. Importantly, each electrode can also be used to stimulate the tissue with optimal efficiency due to the 3D structure. In conclusion, we biologically validate a new recording device characterized by the highest spatio-temporal resolution reported for a 3D MEA and significant improvements in the quality of recordings, with a high signal-to-noise ratio and improved tissue vitality.

Characterization of circadian modulators in relay stations of prefrontal-to-hippocampal circuits via viral tracing and laser microdissection

Lara Mariel Chirich Barreira¹, Julia U. Henschke^{2,3}, Janelle M.P. Pakan^{2,3,4}, Anne Albrecht^{1,2}

¹Otto von Guericke Universität Magdeburg, Institut für Anatomie, Leipziger Str. 44 (Haus 43), 39102 Magdeburg, Germany

²Center for Behavioral Brain Sciences (CBBS), Universitätsplatz 2, 39106 Magdeburg, Germany

³Institute of Cognitive Neurology and Dementia Research, Otto-von-Guericke-University Magdeburg, Leipziger Str. 44, 39120 Magdeburg, Germany

⁴German Centre for Neurodegenerative Diseases, Leipziger Str. 44, 39120 Magdeburg, Germany

Various factors of our modern human life interfere with circadian rhythms, for example artificial light delivered by screens, delayed sleep routines and shift work. These interferences have been associated with memory deficits and are observed in neurodegenerative disorders. In humans and rodents, impaired cognitive function due to circadian strain has been linked to a disrupted medial prefrontal cortex (PFC) to hippocampus (HC) information flow. Two major pathways exist to relay information from the PFC to the HIP that involve projections from the supramammillary area (SUM) to the CA2 and the dentate gyrus (DG) and from the Nucleus reuniens (NRe) to CA1 of the HC. As a first step to understand the underlying circuits involved in circadian disruptions of cognitive function, we analyze here the inputs of circadian neuromodulator cell populations to the SUM and the NRe pathways that participate in the PFC-HC circuit.

In order to identify relevant neurons within these circuits, adeno-associated viral construct was injected in the mPFC of mice to label anterograde projections to the Sum and NRe. In a different cohort, a retrograde tracing virus was injected into the DG. In both groups, tagged and non-tagged cell populations were captured using laser microdissection, their mRNA was isolated, and their sequences reversely transcribed. Gene expression levels of selected orexinergic, adrenergic, GABAergic, histaminergic and purinergic receptors were determined via qPCR. Quantification was done using relative quantification compared to the non-tagged samples. In addition to the single-tracing approach, additional animals were injected with combined anterograde vectors in the PFC, resulting in the expression of tdTomato reporter in the target cells, and retrograde vectors in the DG that express GFP. The proportion of such double projecting neurons in the SUM was analyzed and their expression of the orexin receptor type 1 was determined by immunohistochemical staining of slices containing the SUM.

The current study found that neurons populations in the NRe that receive projections from PFC showed a significantly lower expression level of orexin receptor type 1 mRNA and a significant increase in both GABA-A receptor (Gabra2 subunit) and Histamine 3 mRNA compared to non-tagged neurons in the same area. However, SUM neurons that received projections from PFC did not show significant differences for any mRNA compared. Neurons in SUM that sent projection to DG had significantly less expression of Gabra2 and orexin receptor type 2 mRNA compared to non-tagged neurons. The quantification of expression levels

for histamine 1 by anterograde tracing in both areas and Adora 2a expression in SUM for both tracers was not possible due to minimal expression levels in the isolated populations. The double tracing experiment revealed a cell population with a direct connection between mPFC and DG through the SUM in addition to cells that receive either PFC inputs or transfer to DG.

This research extends our knowledge of differential expression levels for orexin receptors and Gabra2, which will be considered in future pharmacological studies of SUM and NRe relay function in cognition under circadian strain. The orexinergic system represents a potential target for interventions to reverse memory impairments produced by circadian disturbances.

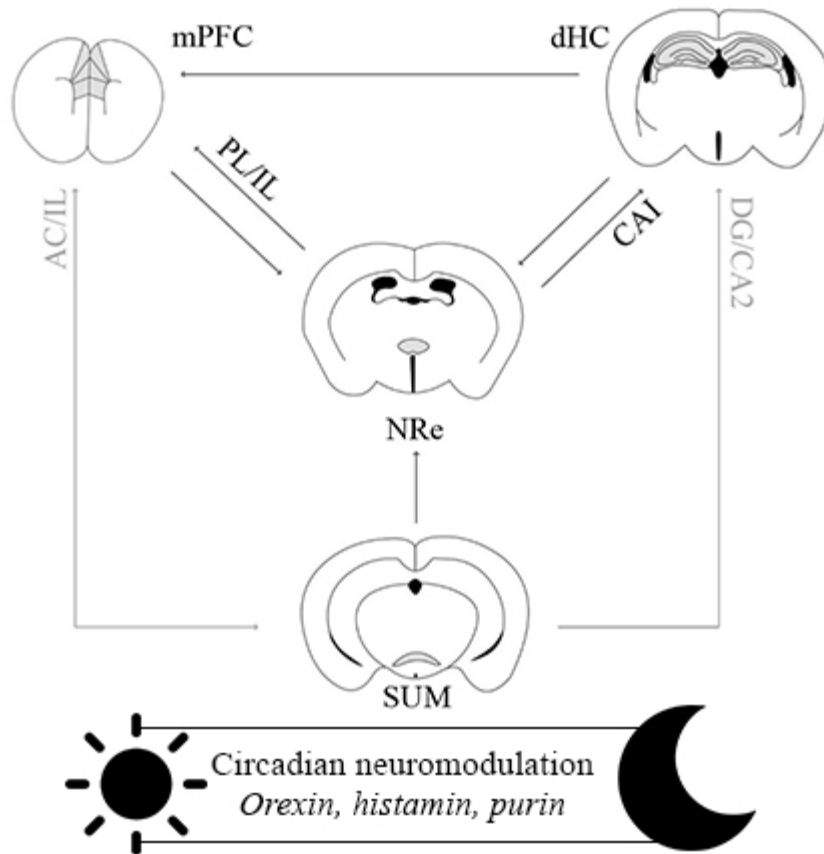

Connectivity Analysis of the Monoaminergic Systems of *Drosophila* Brain

Jiajun Zhang¹, Nikolaj Rieger¹, Kei Ito¹, Thomas Riemensperger¹

¹University of Cologne, Experimental Morphology and Neurobiology, Ito Lab, Zùlpicher Str. 47b, 50674 Köln, Germany

Monoamines are important neuromodulators in both vertebrates and invertebrates. The nervous system of fruit fly *Drosophila melanogaster* utilizes four major aminergic neurotransmitters: indolamine **serotonin** and three catecholamines: **dopamine**, **tyramine**, and **octopamine**. The functions of these monoamines appear partly redundant and partly complementary and are implicated in the regulation of diverse life functions. All the four types of neurons send their projections broadly over large parts of the adult brain. Previous studies let us assume that the circuits of modulatory systems are strongly interconnected among each other, but how individual neurons interact with each other remains unknown. Although these neurons transmit signals in two ways - directly and specifically via chemical synapses and broadly via non-specific diffusion of their transmitters – direct connections should play faster and more important roles for their intermodulation.

Synapse data in the recently published electron microscopy connectome database (FlyEM hemibrain) should become an important tool to better understand the interactions between those aminergic neuromodulator systems, but only a fraction of these neurons have been mapped in the dataset. To address this problem, we mapped nearly all the serotonin-, dopamine- and tyramine/octopamine-producing cells in the hemibrain dataset by searching the matching neurons with single-cell light microscopy data of each neuron type. This enabled us to characterize the global circuit connections across modulatory neurons. Our analysis indicates that certain groups of monoaminergic modulatory neurons display extensive bidirectional interconnections with other groups of neurons of the same neurotransmitter system or those of other monoaminergic systems. Some modulatory neurons display specific unidirectional interaction to other modulatory neurons, whereas other modulatory neurons have very scarce or even no connections to other modulatory neurons.

Our detailed connectivity analysis and connectome-based categorization of the aminergic neuromodulatory systems in the fly brain will provide new insights on the understanding of complex adaptive brain functions such as behavior modulation.

Consequences of Axonal Dysfunctions for Network Oscillations in a Mouse Model of Dravet Syndrome

Raquel Lascorz Massanet¹, Fabian C. Roth¹

¹Division of Physiology, Department of Molecular Medicine, Institute of Basic Medical Sciences, University of Oslo, 0317 Oslo, Norway

Dravet syndrome (DS) is a rare childhood epilepsy with an early onset characterized by febrile seizures followed by spontaneous seizures occurring into adulthood. Further, DS includes a high number of sudden unexplained death (~20%) and children with DS show comorbidities including severe cognitive deficits, autistic traits and ataxia. DS was shown to strongly correlate with pathogenic loss-of-function variants in the SCN1A gene that encodes the voltage-gated sodium channel α subunit Na_v1.1. This subunit is mainly expressed in axons of GABAergic cells, including Parvalbumin-expressing interneurons (PV-IN). In accordance with a large body of data on deficits in PV-IN functions, there have also been found changes in network activities, such as sharp wave ripple oscillations (SPW-R). However, the underlying mechanisms remain poorly understood. In our study, we investigate the hypothesis whether an altered number or composition of sodium channels disturbs axonal currents underlying action potential (AP) generation and conduction, which then impairs rhythmic synaptic inhibition in cortical networks.

Field potential and patch-clamp recordings are performed in the hippocampal CA1 region of heterozygous Scn1a^{+/-} KO-mice and Scn1a^{+/+} littermates in vitro. We use simultaneous recordings of network oscillations, individual neurons, and subcellular structures to study PV-IN activities during SPW-R to reveal how deficits in axonal Na_v1.1 channels account for disturbed network activities. Due to the sudden increase of mortality of mice around postnatal day (P) 24, the analysis is separated into two age groups: P18-23 and P30-35 (survivors).

Consistent with in vivo studies, recordings from hippocampal slices reveal that sharp-wave ripple oscillations in surviving Scn1a^{+/-} mice at P30-35 show a lower frequency of ripple oscillations compared to littermate control mice, while younger Scn1a^{+/-} mice aged P18-23 also show an increased occurrence of SPW-R. While no general impairment of AP generation was observed in PV-IN of Scn1a^{+/-} mice, both stimulation-induced and spontaneous APs showed reduced amplitudes, reduced slope, increased duration, and smaller afterhyperpolarizations, all consistent with reduced sodium channel activity. By studying axonal dysfunctions and their direct effects on complex network activities within the same slice, we can account for the reported interindividual differences in phenotype severity of Scn1a^{+/-} mice. This enables us to provide new insights into how axonal ion channel activities are linked to network activities and into the disease-specific axonal deficits in DS.

DEND mutation disrupts hippocampal network activity and nocturnal γ shifts

Kristina Lippmann¹, Marie-Elisabeth Burkart¹, Josephine Kurzke¹, Jorge Vera², Frances Ashcroft³, Jens Eilers¹

¹Carl-Ludwig-Institute of Physiology, Medical Faculty, Leipzig University, Liebigstr. 27, 04103 Leipzig, Germany

²Dominick P. Purpura Department of Neuroscience, Albert Einstein College of Medicine, NY, USA

³Department of Physiology, Anatomy and Genetics, Henry Wellcome Building for Gene Function, University of Oxford, Oxford, UK

ATP-sensitive potassium (K_{ATP}) channels allow intracellular ATP to control the membrane potential, a process well known for insulin secretion of pancreatic β cells. Humans affected by activating mutations of K_{ATP} channels suffer from developmental *delay*, epilepsy and *neonatal diabetes*, i.e., DEND syndrome. While the development of diabetes in DEND syndrome is well understood, the pathophysiology of the neurological symptoms remains unclear. We hypothesized that inhibitory parvalbumin-positive interneurons (PV-INs) are key both for the occurrence of epilepsy as well as for the developmental delay. PV-INs generate energy-demanding burst activity known to be crucial for cognition-associated hippocampal sharp waves (SPWs) and gamma oscillations; dysfunction of PV-INs can result in epilepsy. We generated mice expressing the DEND mutation $K_{ir6.2}$ -V59M selectively in PV-INs. We found that the mutation leads to reduced intrinsic gamma behavior and GABA release of PV-INs as well as to disturbed gamma oscillations and SPW activity in acute hippocampal slices. Long-term in vivo recordings revealed an increased risk for seizures and a disrupted day-night shift in gamma activity. Our observations attribute PV-INs a key role in DEND syndrome and provide a framework for establishing treatment options for affected individuals.

Dendritic axon origin enables selective information gating by perisomatic inhibition in pyramidal neurons

Martin Both¹, Alexander Hodapp¹, Martin E Kaiser¹, Christian Thome^{1,2,3}, Lingjun Ding^{4,5,6}, Andrei Rozov^{1,7,8}, Matthias Klumpp¹, Nikolas Stevens¹, Tina Sackmann¹, Nadja Lehmann⁹, Andreas Draguhn¹, Andrea Burgalossi^{4,5}, Maren Engelhardt^{2,9}

¹Universität Heidelberg, Institut für Physiologie und Pathophysiologie, Im Neuenheimer Feld 326, 69120 Heidelberg, Germany ²Institute of Anatomy and Cell Biology, Medical Faculty, Johannes Kepler University, Linz, Austria ³Institute for Stem Cell Biology and Regenerative Medicine, Stanford University, USA ⁴Institute of Neurobiology, University of Tübingen, Germany ⁵Werner-Reichardt Centre for Integrative Neuroscience, Tübingen, Germany ⁶Graduate Training Centre of Neuroscience, IMPRS, Tübingen, Germany ⁷Federal Center of Brain Research and Neurotechnologies, Moscow, 117997 Russian Federation ⁸OpenLab of Neurobiology, Kazan Federal University, Kazan 420008, Russian Federation. ⁹Institute of Neuroanatomy, Mannheim Center for Translational Neuroscience (MCTN), Medical Faculty Mannheim, Heidelberg University, Germany

Information processing in cortical pyramidal neurons involves the specific activation into functional ensembles. In this process, only a minority of neurons is recruited while the majority remains silent. This sparse activation is believed to result from widespread perisomatic inhibition in conjunction with specific synaptic excitation. We have previously shown that in ~50% of hippocampal pyramidal cells the axon emerges from a basal dendrite. Here, we propose that this particular morphology provides a mechanism for selective activation of participating neurons through these morphologically unique axo-dendritic compartments.

In awake, head-fixed mice, we found that CA1 pyramidal neurons with a dendritic axon origin displayed a ~4-fold higher firing frequency during network activation compared to neurons with somatic axon origin. This difference was absent outside ripples. Extra- and intracellular recordings in mouse brain slices and computer simulations led us to hypothesize that the axon is forming a functional unit together with the axon-carrying dendrite. We show that excitatory input to axon-carrying dendrites remains efficient even during strong perisomatic inhibition. Other dendrites become uncoupled from this compartment, preventing their input to trigger action potentials. This may likewise apply to all neurons with somatic axon origin. Therefore, cells with axon-carrying dendrites may be privileged members of neuronal ensembles during states of strong perisomatic inhibition, such as fast network oscillations. By this mechanism, activation of inhibitory interneurons and targeted excitation of the respective dendrite may dynamically and rapidly change the functional network topology, resulting in the activation of defined neuronal ensembles. In summary, our findings show that the recruitment of neurons into active ensembles is determined by axonal morphological features - a novel cortical coding mechanism which could generalize beyond the hippocampus.

Developmental network embedding of PV interneurons in relation to the emergence of gamma rhythms in the prefrontal cortex

Anton Offermanns¹, Jastyn A. Pöplau¹, Ileana Hanganu-Opatz¹

¹Center for Molecular Neurobiology Hamburg, Institute of Developmental Neurophysiology, Falkenried 94, 20251 Hamburg, Germany

The prefrontal cortex (PFC) is considered as the hub of cognitive processing and necessary for decision-making, working memory and attention. Prefrontal gamma oscillations are commonly used as proxy of neuronal processes during these tasks. According to the principle of cortical hierarchy, gamma emergence in the PFC is delayed when compared to other brain areas and show a prominent increase in frequency and amplitude, occurring between the second and fourth postnatal week in mice. Parvalbumin-positive (PV⁺) interneurons control gamma generation and show a similar developmental time-course with an age-dependent increase in PV expression and the maturation of firing properties. While the expression of somatostatin in the PFC remains stable with age, studies in sensory cortices have revealed a decrease of somatostatin-positive (SOM⁺) interneuron mediated inhibition of PV⁺ interneurons during early postnatal development.

Considering these parallels between PV⁺ interneuron and gamma development, the question arises whether PV-dependent changes within local prefrontal microcircuits causally mediate the emergence of gamma oscillations. To address this question, we recorded local field potential and single unit activity while optogenetically stimulating layer 2/3 pyramidal neurons (PYRs) and simultaneously inactivating PV⁺ or SOM⁺ interneurons in the PFC of mice between postnatal week 2 and 9. For this, layer 2/3 PYRs were transfected with channelrhodopsin 2 (ET/TC) by *in utero* electroporation. PV⁺ or SOM⁺ interneurons were targeted with somBiPOLES in a Cre-dependent manner by using viral injections.

We show that during the third postnatal week PV⁺ interneurons become increasingly integrated within prefrontal circuits and contribute to the frequency acceleration of fast oscillations and emergence of mature gamma oscillations. We hypothesize that an increase in recurrent connections between PV⁺ interneurons and PYRs as well as a decrease in SOM⁺ interneurons mediated inhibition causes the observed shift from beta to gamma frequency range. Indeed, activating layer 2/3 PYRs while inhibiting PV⁺ at adult age leads to the generation of beta oscillations that are reminiscent to the activity patterns recorded during the second postnatal week.

Thus, developmental network embedding of PV⁺ interneurons contributes to the emergence and acceleration of gamma oscillations, most likely mediated by a shift from SOM⁺ dominated circuits towards PV⁺ dominance.

Different involvement of axon-carrying dendrite versus canonical neurons during learning processes

Nadja Sharkov¹, Matthias Klumpp¹, Nikolas Stevens¹, Christian Thome^{1,2,3}, Janina Kupke⁴, Andreas Draguhn¹, Ana M. M. Oliveira⁴, Martin Both¹

¹Institute of Physiology and Pathophysiology, Medical Faculty, Heidelberg University, Germany

²Institute of Anatomy and Cell Biology, Medical Faculty, Johannes Kepler University, Linz, Austria

³Institute for Stem Cell Biology and Regenerative Medicine, Stanford, USA

⁴Interdisciplinary Centre for Neurosciences – Neurobiology, Heidelberg University, Germany

The hippocampus is important for the formation of declarative memories. It generates distinct network oscillations, during which functional ensembles are specifically activated. The formation of coherently active ensembles requires integration of multiple synaptic inputs within single neurons. According to current understanding, dendritic excitatory synaptic potentials are integrated at the soma which is directly connected with the axon. Signal flow to the axon can be blocked by perisomatic inhibition which is particularly active during network oscillations. Recently, we have shown that in about 50% of hippocampal CA1 pyramidal neurons the axon emerges from a basal dendrite (AcD, 'axon-carrying dendrite'). This particular dendrite is largely independent from somatic signal integration and can efficiently convert excitatory inputs into APs, even under conditions of strong perisomatic inhibition. We therefore hypothesize that AcD cells are more active during states of strong perisomatic inhibition. Based on this mechanism, AcD and canonical cells might be differently involved in the formation and consolidation of episodic memory.

To test this hypothesis, we trained mice on a spatial memory task (m-maze). Active neurons are expected to express immediate early genes (e.g. cFos), and can be identified by ex vivo staining. Additional staining of the axon initial segment enabled us to sort task-activated neurons into AcD and canonical cells. Interestingly, in the ventral hippocampus the number of cFos-expressing AcD cells is particularly high on day 5 while non-AcD cells express cFos stronger on day 7. In contrast, in the dorsal hippocampus the cFos expression is particularly strong on day 3 and decreases over time. While the underlying mechanisms are presently unclear it does, however, indicate distinct roles of AcD and non-AcD cells during formation and consolidation of memory as well as differences in the dorso-ventral axis of CA1.

Disinhibitory Circuit Motifs in Mouse Primary Somatosensory (Barrel) Cortex

Felix Preuß¹, Martin Möck¹, Mirko Witte¹, Jochen F. Staiger¹

¹University Medical Center Göttingen, Institute of Neuroanatomy, Kreuzberggring 36, 37077 Göttingen, Germany

Introduction

GABAergic Interneurons (IN) play a crucial role in information processing in the rodent neocortex and are well integrated into the circuitry of the mouse barrel cortex. They are also targeted by other IN, a circuit motif which is known as disinhibition. It has been reported that layer 2/3 (L2/3) SST cells are targeted by vasoactive intestinal peptide (VIP) and parvalbumin (PV) expressing IN, but little is known about the disinhibitory circuitry of L5 SST cells.

Material and Methods

We performed intralaminar (L5 to L5) paired patch clamp recordings of PV and VIP neurons to SST cells in barrel cortex of mice using acute brain slices. Since L2/3 VIP cells are characterized by an ascending axon, we also performed patch clamp experiments of translaminar L2/3 VIP to L5 SST cells. After experiments, slices were stained and individual pairs were morphologically reconstructed.

Results

Paired patch clamp recordings resulted in a connection probability of 25 % for the intralaminar L5 PV to L5 SST connection, 26 % for the intralaminar L5 VIP to L5 SST connection and 30 % for the translaminar L2/3 to L5 SST connection. Single action potentials led to postsynaptic responses in 50 % of both unitary VIP to SST connections while the synaptic success rate was 90 % in the PV to SST connection. PV to SST amplitudes were significantly larger and had significantly decreased latencies. Train stimulation of PV cells resulted in synaptic depression at all tested frequencies (1, 8 and 40 Hz) stimulation while both VIP connections were facilitating but only at 40 Hz stimulation.

Conclusion

We could demonstrate that L5 PV, L5 VIP and L2/3 VIP neurons effectively target L5 SST cells, thereby confirming and extending the VIP and PV to SST connection as a prominent disinhibitory circuit motif in mouse barrel cortex.

Dynamics in timing of the sounds of *Mecopoda elongata*

Reinhard Lakes-Harlan¹

¹University Giessen, Integrative Sensory Physiology, Heinrich-Buff-Ring 26, 35392 Giessen, Germany

Males of the katydid *Mecopoda elongata* produce a calling sound to attract conspecific females. Sound chirps of about 500ms duration are repeated to form a verse of about 13 minutes duration. The chirp interval is temperature dependant and is about 2.5 seconds. Such numbers are used to characterize the species specific parameters of acoustic signalling.

However, the numbers given above do not reflect the high dynamics in timing in this system, raising questions about the underlying neural pattern generator.

Firstly, from recordings of single individuals it has been observed that the interval changes within a verse. Usually the interval is at the beginning of a verse higher than 2.5s and variable, before timing stabilises.

Secondly, intervals within the first verse are shorter than those of later verses. Therefore, a parameter with longer duration (hours) effects the pattern generator as well.

Thirdly, the pattern is even more variable in groups with interacting individuals. Recordings were performed with a sound camera of chorus signalling in groups of 2, 4, 8 or 12 individuals. Individuals can synchronize their calling, but they can also desynchronize the calling (figure)! The two types have different chirp interval and animals can repeatedly switch between the two types by varying the chirp interval. Thus, the pattern generator is highly influenced by social interaction.

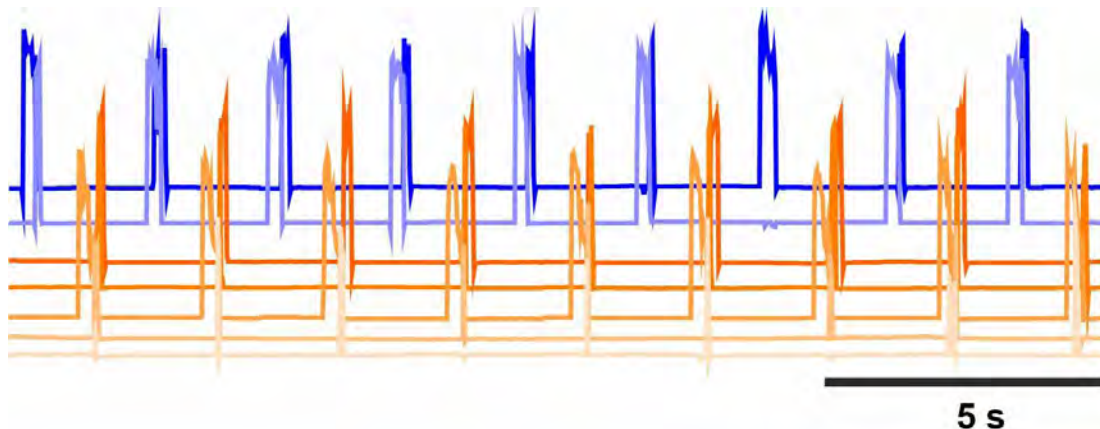

Auditory activity in a desynchronous chorus of *Mecopoda elongata*. Two animals (blue) are out of phase with the group of five other animals (brownish). Both groups have a stable timing.

Electrophysiological Characterization and Computational Modeling of Insulin-Producing Cells in *Drosophila*

Federico Cascino-Milani¹, Lorenzo Fontolan², Sabine Fischer³, Jan M. Ache¹

¹Neurobiology and Genetics, Theodor-Boveri-Institute, Biocenter, Julius-Maximilians-University of Würzburg, Am Hubland, 97074 Würzburg, Germany

²Janelia Research Campus, 19700 Helix Drive, Ashburn VA 20147, USA

³Supramolecular and Cellular Simulations, Center for Computational and Theoretical Biology, Biocenter, Julius-Maximilians-University of Würzburg, Klara-Oppenheimer-Weg 32, Campus Hubland Nord, 97074 Würzburg, Germany

Insulin-Producing Cells (IPCs) are an important population of modulatory neurons in the insect brain that release Insulin-like Peptides (ILPs). ILPs have been demonstrated to play a key role in metabolic homeostasis, aging, development, and the modulation of behavior in different species, including *Drosophila melanogaster*, our model of choice. Quantifying IPC activity dynamics is crucial to developing an understanding of insulin signaling, but this task is quite challenging: IPCs are interconnected with a complex network of neuromodulatory neurons that have a wide variety of effects on IPCs and form numerous direct and indirect reciprocal connections. Due to the complexity of this system, an experimental approach is insufficient to develop a comprehensive understanding of the neuronal mechanisms that underlie the modulation of IPC activity, and thus insulin release. Theoretical models are powerful tools to study the dynamics of such interactions in a coherent framework. Hence, we decided to use a combined approach of electrophysiological characterization and computational modeling to study IPCs and the complex network they are part of.

Here, we developed a conductance-based model of IPCs using data collected in electrophysiological experiments. Patch-clamp recordings of individual IPCs and optogenetic functional connectivity experiments were performed to quantify the intrinsic electrophysiological properties and to characterize some of the key modulatory inputs of this neuronal population. Optimization of our model to fit the experimental data allowed us to study combined effects of different neuromodulators on the activity of an individual IPC. This data-driven model will be expanded to include the entire population of IPCs to analyze how neuromodulators produce circuit-level changes that affect the IPC network. These results will contribute to broaden our understanding of neuromodulation and metabolism in general.

Functional Analysis of Neuropeptides in the Accessory Medulla of the Madeira Cockroach *Rhyparobia maderae*

Sohail H. Shoaib¹, Susanne Neupert¹, Monika Stengl¹

¹Universität Kassel , Tierphysiologie , Heinrich plett straße 40, 34132 Kassel, Germany

Lesion experiments located the circadian pacemaker of the clock of the Madeira cockroach *Rhyparobia (Leucophaea) maderae* to the accessory medulla (AME). Being located ventromedially in the optic lobes, the AME receives photic input from the compound eye photoreceptors and synchronizes the circadian rhythms, both physiologically and behaviorally, to the 24h light-dark cycles. About 240 neurons innervate the AME, which are rich in different co-localized neuropeptides. Among them pigment dispersing factor (PDF) is the best studied insect circadian clock neuropeptide. On the other hand, the functions of most of the other neuropeptides in the AME are still a mystery. The nocturnal Madeira cockroach rests during the day and is active during the night. In mammals as well as in insects it was suggested that sleep wake patterns are adjusted to different photoperiods during the year with two oscillator circuits per bilaterally symmetric circadian clock. A morning (M) oscillator that locks onto dawn and an evening oscillator (E) that locks onto dusk. In *Drosophila* the small ventrolateral clock neurons release PDF and express PDF-receptors. They are M clock neurons. In contrast, other neuropeptidergic clock neurons which do not express PDF but are PDF sensitive belong to the E clock. In the Madeira cockroach M and E clock circuits are not known yet. However, ELISAs showed that PDF concentrations are maximal during the day when the cockroaches are resting. Furthermore, Ca²⁺ imaging studies combined with PDF applications and PDF-immunocytochemistry showed that PDF-expressing neurons that project to the contralateral AME are inhibited by PDF. In contrast, all ipsilateral remaining PDF expressing neurons are activated by PDF. Since PDF controls sleep wake cycles, we followed from these data that the contralateral PDF cells that are suppressed during the day are evening cells promoting activity in the nocturnal cockroach. In contrast, the ipsilateral PDF cells that are activated during the day are M cells which are sleep promoting during the day.

Using Ca²⁺ imaging, now we further challenge this hypothesis. We search for neuropeptide-receptors in PDF-sensitive versus non-PDF sensitive neurons that belong to M or E clock circuits. With backfills from one AME we stain contralaterally projecting clock neurons before we generate primary cell cultures of AME clock neurons. We want to know whether we can distinguish/identify differential sensitivity in M and E clock circuits. We expect that neuropeptides that were found to advance the clock such as corazonin, connect to the M clock neurons, while neuropeptides that were shown to delay locomotor activity rhythms in running wheel assays, such as allatotropin connect to the E clock. Future experiments will further distinguish neuropeptide and neuropeptide receptor expression M and E clock neurons to allow for modelling of circadian clock circuits. [Supported by DFG grants STE531/26-1 to MS and by RTG 2749/1 "multiscale clocks" and STE 531/27 and NE 911/5-1 to SN]

Functional characterization of long-range GABAergic projections from the medial septum to the lateral entorhinal cortex

Viktoria B. Pfennig¹, Yu-Chao Liu¹, Elke C. Fuchs¹, Hannah Monyer¹

¹Medical Faculty of Heidelberg University and German Cancer Research Center (DKFZ), Department of Clinical Neurobiology, Im Neuenheimer Feld 280, 69120 Heidelberg, Germany

Together with the medial entorhinal cortex (MEC), the lateral entorhinal cortex (LEC) provides one of the major cortical inputs to the hippocampus and is crucial for object-related memory formation. Known to serve as the main external input to the entorhinal cortex (EC), the medial septum (MS) generates and sustains theta oscillations, which are pivotal for episodic learning and memory retrieval. Of note, in contrast to the MEC, neurons in LEC are only weakly modulated by theta oscillations. While cholinergic, GABAergic, and glutamatergic long-range projections from the MS to the MEC have been widely studied, knowledge regarding septal GABAergic modulation of the LEC and the cause for weaker theta oscillations has remained incomplete. Here we provide evidence for septal calbindin-positive (CB⁺) GABAergic neurons project abundantly to the LEC. We characterized the target cells combining optogenetics and whole-cell patch clamp recordings, and found that the projections targeted only interneurons and not excitatory cells. Furthermore, unlike septal CB⁺ projections to the MEC that exhibit cellular target specificity (they inhibit low-threshold-spiking interneurons only), septal CB⁺ projections to the LEC inhibit a plethora of GABAergic interneurons. Thus, these projections are the source of a pronounced inhibitory modulation of local networks in the target area. However, the low cellular specificity implies multiple functions at the network and most likely behavioral level. Additionally, we were able to show that targeted LI and LII interneurons in the LEC expressed depolarization-induced suppression of inhibition (DSI). Taken together, our findings demonstrate that local networks in LEC, although in a different manner than in MEC, are strongly modulated by septal GABAergic projections.

Higher-order anatomical connectivity explains functional properties of visual circuitry

Juan Felipe Vargas Fique¹, Sebastian Molina-Obando¹, Marion Silies¹

¹Johannes Gutenberg Universität Mainz, Neural Circuits Lab, Institute for Developmental Neurobiology, Hans-Dieter-Hüsch weg 15, 55128 Mainz, Germany

Functional connectomics aims to understand the relationship between anatomical connectivity and the function of neural circuits. Full EM-based connectomes of fly circuitry that computes motion exist¹ and have informed functional models, but how predictive EM-based connectomes are of circuit function is not fully known. We used the fly visual circuit that detects the direction of bright (ON) motion as an experimental model, where motion computations are considered to be implemented in T4 neurons by parallel feedforward input motifs that have been informed by connectomics. Nevertheless, silencing individual neurons fails to fully abolish motion-guided behavior². Here we show that second-order, non-feedforward connections are functionally relevant in this circuit. We genetically generated flies with minimal circuit motives by first abolishing ON responses in a mutant of the glutamate gated chloride channel *GluCl α* and selectively rescuing individual inputs. Rescue of *GluCl α* in one interneuron (Mi1) leads to the rescue of the direction-selective output of the circuit. Motion computation requires a spatio-temporal comparison that is achieved by multiple cell types^{1,2}, arguing that second- or higher order connections accounts for the functional rescue. Analysis of connectivity patterns suggested that Mi1 is a hub neuron, with more non-feedforward connections to other neurons within the circuit than other interneurons. As predicted by the connectivity analysis we found that Mi1 is capable of functionally rescuing other inputs to T4 within the circuit and, the less interconnected Tm3 neuron (which is also part of core motion-detection circuit), was unable to rescue the circuit output by means of *GluCl α* overexpression. We conclude that higher-order connectivity must be considered when predicting functionally relevant circuit properties.

1. Takemura, S., et al., (2017). The comprehensive connectome of a neural substrate for 'ON' motion detection in *Drosophila* eLife 6:e24394.
2. Strother, JA., et al., (2017) The emergence of directional selectivity in the visual motion pathway of *Drosophila*. Neuron. 94(1):168-182.

Investigating the coupling between surplus spike synchrony and slow oscillations in the dorsal hippocampus

Regimantas Jurkus^{1,4}, Julien Fiorilli^{2,4}, Thijs R. Ruikes², Sonja Grün^{1,3}, Cyriel M. A. Pennartz², Michael Denker¹

¹Institute of Neuroscience and Medicine (INM-6) and Institute for Advanced Simulation (IAS-6) and JARA-Institute Brain Structure-Function Relationships (INM-10), Jülich Research Centre, Jülich, Germany

²Cognitive and Systems Neuroscience Group, SILS Center for Neuroscience, University of Amsterdam, Amsterdam, The Netherlands

³Theoretical Systems Neurobiology, RWTH Aachen University, Aachen, Germany

⁴Equal contribution

Surplus spike synchrony of a simultaneously recorded neuron pair can be quantified by the Unitary Event (UE) analysis method [1-3]. UEs indicating significant synchronous spikes on a millisecond timescale have been related to oscillations of the local field potential (LFP) and show coupling between LFP phase and UEs in the primate motor [4] and visual [5] cortices. Here, we set out to investigate if a similar coupling is present in the rodent hippocampus during an object recognition task involving tactile, visual and visuotactile object sampling.

We quantified UEs in five separate recording sessions of single unit recordings in the dorsal hippocampus. Trials of all three modalities were pooled and aligned on the moment of retraction at the end of object sampling, marked by the rat's withdrawal from the object and the start of locomotion toward the reward location. We also investigated the delta (1 – 4 Hz) and theta (4 – 12 Hz) oscillations of the LFP recorded simultaneously but from separate electrodes in the hippocampus. The LFP analysis revealed a clustering of the instantaneous phase across trials in the delta, but not theta band around the moment of retraction. Additionally, the instantaneous amplitude of the theta band LFP tended to be higher before than after the retraction. Finally, we found a significant delta phase and theta amplitude coupling surrounding the moment of retraction.

We then combined the detected UE spikes and the instantaneous delta and theta phase to construct phase distributions triggered on UE and chance-coincident spikes (CCS). We also compared these to a predictor (PRE, [4, 6]) computed as the joint distribution of individual spike-triggered phases of the two neurons. Both delta and theta UE-triggered phase distributions of individual recording sessions exhibited deviations from uniformity. For the delta band, the UE and CCS distributions showed high variability, whereas for the theta band the three distributions tended to be similar. Moreover, only for theta a clear and consistent preferred phase around the falling phase of the oscillation cycle could be determined across sessions. The delta and theta distributions were averaged across LFP sources for each recording session. The averaged delta phase distributions indicated a variable UE phase preference, which was more pronounced compared to that of CCS and PRE distributions. In contrast, the averaged PRE, CCS and UE theta phase distributions consistently clustered around the falling phase of the theta oscillation.

We relate our findings on the cross-trial synchronization of LFP around the end of object sampling to the evidence for the presence of coupling between excess spike synchrony and slow oscillations in the rodent

dorsal hippocampus. Furthermore, we discuss the potential behavioral relevance of these observations.

Acknowledgements

The authors would like to thank Junji Ito for constructive comments. This project has received funding from the European Union's Horizon 2020 Framework Programme for Research Innovation under Specific Grant Agreements No. 785907 (Human Brain Project SGA2) and 945539 (Human Brain Project SGA3).

References

- [1] Riehle et al 1997 *Science* 278 (5345), 1950–1953
- [2] Grün et al 2002 *Neural Comput* 14 (1), 43–80
- [3] Grün et al 2002 *Neural Comput* 14 (1), 81–119
- [4] Denker et al 2011 *Cereb Cortex* 21 (12), 2681–2695
- [5] Ito et al 2011 *Cereb Cortex* 21 (11), 2482–2497
- [6] Denker et al 2010 *J Comp Neurosci* 29, 599–613

Investigation of the involvement of pigment-dispersing factor (PDF) and other neuropeptides in seasonal adaptation to the changing photoperiod in the cockroach *Rhyparobia maderae*

Huleg Zolmon¹, Susanne Jaguttis¹, Monika Stengl¹

¹University of Kassel, Animal Physiology, Heinrich-Plett-Straße 40, 34132 Kassel, Germany

Due to the earth's rotation around its axis and its rotation around the sun, organisms are exposed to a day-night cycle of about 24 h as well as to changing photoperiods at a cycle of a year. To anticipate favourable times for rest and specific activities, organisms evolved endogenous circadian clocks that generate a rhythm of about 24 hrs. In addition, internal clocks allow adaptations to the changing length of daylight during the year. The Madeira cockroach *Rhyparobia maderae* is an established model of chronobiology. Transplantation experiments identified the accessory medulla (AME) in the brain's optic lobes as the circadian clock that controls rest-activity cycles. Immunocytochemical and behavioral studies showed that AME clock neurons (PDFAMEs) expressing the neuropeptide pigment-dispersing factor (PDF) orchestrate sleep wake cycles of the cockroach. We want to know whether/how an equatorial cockroach that evolved under equinox conditions does adjust to acute/permanent changes in photoperiod with its PDF expressing circadian clock.

Apparently, adaptation to changes in photoperiod involve two circadian oscillator circuits: the morning (M) oscillator locked to dawn and the evening (E) oscillator tracking dusk. While in the fruitfly *Drosophila melanogaster* PDF expressing clock cells are only part of the M clock, morphologically distinct PDF clock cells of *R. maderae* appear to participate in M- and E clocks (Gestrich et al., 2018). Beside PDF, we investigate the short neuropeptide F (sNPF) and allatostatin C (AstC), as possible candidates to be involved in either the M or E oscillator network.

Here, we describe changes in mRNA levels of PDF precursor in cockroaches acutely transferred to different photoperiods. They showed elevated mRNA levels of PDF precursor under long-day conditions (LD 18:6), and decreased levels in short-day conditions (LD 6:18) compared to cockroaches from LD 12:12. Furthermore, the numbers of PDF-immunoreactive neurons anterior and posterior to the accessory medulla (PDFAMEs) were affected by acute transfer of adult cockroaches to different photoperiods. The posterior group of PDFAMEs increased in number in long-day conditions and an anterior group decreased under short-day conditions. Additionally, we found sNPF mRNA levels to increase only under long-day conditions, while AstC mRNA levels appeared to decrease in long-day conditions. In conclusion, also the equatorial Madeira cockroach adapts to different photoperiods either when raised in different photoperiods, or even when adults were acutely transferred to a new photoperiod. Interestingly, the duration of light per day changed the expression of various neuropeptide precursors distinctly in different neuronal groups associated with the circadian clock of the Madeira cockroach. Now, our experiments focus on examination of respective mechanisms.

[Supported by DFG grants STE531/18-3, STE531/25-1, STE531/26-1; STE531/27-1 to MS; and by GRK 2749/1]

Ionic currents in insect circadian clock neurons

Anna C. Schneider¹, Monika Stengl¹

¹University of Kassel, Biology, Animal Physiology/Neuroethology, Heinrich Plett Str. 40, 34132 Kassel Germany

Circadian and ultradian rhythms govern the daily phases of a multitude of physiological processes and behavior in organisms. They control activity and rest phases as well as feeding and mating behavior. Entrainment to geophysical cues, such as daylight, enables synchronization of physiology and behavior across animals of the same species, increasing mating success, and across species, increasing feeding success.

By now, circadian clocks have been identified in the central nervous system of many animals. Besides circadian oscillations of the well-studied molecular clock machinery in the nucleus the electrical activity of clock neurons also cycles daytime dependently, orchestrating postsynaptic neuronal networks that control locomotor activity rhythms. Since the electrical activity of clock neurons continues to oscillate and to drive an animal's behavior even in the absence of rhythmic external cues, clock neurons possess neurophysiological pacemaker properties. While degeneracy exists in the possible combinations of ionic conductances to build effective pacemakers, typical currents include hyperpolarization-activated currents such as I_h (also known as pacemaker current), regenerative currents such as the transient sodium current I_{Na} , and repolarizing potassium currents. It is not resolved yet whether the plasma membrane constitutes a post-translational endogenous clock that is active even in the absence of the molecular clock machinery in the nucleus.

Even though the presence of a circadian clock was first demonstrated in the Madeira cockroach *Rhyparobia maderae* (*Leucophaea maderae*), knowledge about the ionic currents, their interaction, and their modulation by circadian neuropeptides such as pigment-dispersing factor, in the cockroach clock neurons remained sparse. We conducted patch clamp experiments on clock neurons in primary cell cultures of the cockroach circadian clock, located in the accessory medulla, to identify and characterize ionic currents and their response to neuromodulatory substances. We hypothesize that typical pacemaker currents, such as I_h , are expressed at high levels in the clock neurons. In the future, this dataset will serve to build a conductance-based computational model of cockroach clock neurons to examine the interplay of the different currents under different daytime-dependent neuromodulatory conditions and to gain insight into fundamental principles that drive the electrical activity of such clock neurons.

[Supported by DFG grant RTG 2749/1 "multiscale clocks"]

Late developmental dynamics of activity patterns within prefrontal-hippocampal networks in health and a genetic risk model for schizophrenia

Marilena Hnida¹, Jastyn A. Pöpplau¹, Ileana L. Hanganu-Opatz¹

¹Institute of Developmental Neurophysiology, Center for Molecular Neurobiology, University Medical Center Hamburg-Eppendorf, Falkenried 94, 20251 Hamburg, Germany

Complex cognitive abilities involve a neural circuitry that extends across much of the brain, yet it is commonly held that the prefrontal cortex (PFC) in tight coupling with the hippocampus (HP) is a critical hub. With regard to this, the PFC provides executive “top-down” control, accounting for attention, salience detection, working-memory and inhibitory control. It is hypothesized that these abilities mature in parallel with the development of prefrontal circuits and therefore, it is proposed that those emerge relatively late, progressively augment from childhood to young adulthood, and decline only after middle age. However, some aspects of cognitive flexibility, such as decision-making strategies, have been found to reach maximal performance at juvenile age. On a flipside, cognitive disruption, which is related to several neuropsychiatric disorders, such as schizophrenia, is firstly detected during later stages of development, namely during adolescence. Thus, understanding the prefrontal wiring at juvenile age is a critical aim, yet poorly addressed. While our previous studies identified the mechanisms underlying the generation of activity patterns in the PFC during the first postnatal weeks and their role in the pathophysiology of schizophrenia, the dynamics and the role of electrical activity during later developmental periods are still largely unknown. To fill this knowledge gap, we performed multi-site extracellular recordings in the PFC and HP of postnatal day (P) 16-60 mice. The activity patterns were compared to those recorded from Df16(A)^{+/-} mice, which have a heterozygous 1.3 megabase long deletion on chromosome 16. This genetic defect mirrors the 22q11.2 microdeletion in humans, which is associated with an enhanced risk to develop schizophrenia during adolescence or early adulthood. In wild-type mice, prefrontal gamma oscillations and firing progressively augmented in their frequency and amplitude peaking around P30, and decreased afterwards. These developmental gamma features are impaired in the Df16(A)^{+/-} mice. Similarly, the firing in PFC and HP was abnormally timed by oscillatory rhythms during specific time windows of late development. In the HP the power of theta activity progressively augmented with age in wild-type mice and peaks in adolescence, yet this peak is not seen in Df16(A)^{+/-} mice. Moreover, the communication between PFC and HP dynamically evolved with age. The Df16(A)^{+/-} showed a different developmental profile, corresponding to a decreased theta band coupling between the two areas. Thus, we conclude that complex dynamic processes take place during late development and that those processes are disrupted in schizophrenia.

Near-optimal encoding of minimal stimuli in the cortical gateway for somatosensation

Andreas Neef¹, Fred Wolf¹, Michael J Gutnick², Omer Revah²

¹Göttingen Campus Institute for Dynamics of Biological Networks, Germany

²Kohret School for Veterinary Medicine, The Hebrew University of Jerusalem, Rehovot, Israel

In vertebrates, many cortical neurons jointly represent a feature in their collective action potential pattern. The performance of this population coding obviously improves as the number of neurons increases. But it also depends critically on neuron morphology, the kinetics of synaptic receptors, and axonal ion channels. We report that, in rat barrel cortex layer 4, all these parameters appear to be matched for near-optimal encoding, enabling the excitatory population to reliably coding even single, sensory-driven action potentials in thalamic relay neurons. Specifically, the dendrite size of around 200 μ m, long synaptic decay time constants of 7ms, mediated by unusual NMDA receptors with reduced Mg block, the presence of Kv7 channels, and a population size of 1000-3000 neurons jointly lead to the faithful encoding of a single thalamocortical action potential. This matching of parameters across scales, from molecular kinetics to population size, suggests that evolutionary pressure for highly efficient coding shaped multiple aspects of the excitatory cells in layer 4 barrel cortex. We posit that optimal population encoding might be a key objective in cortical structures in general.

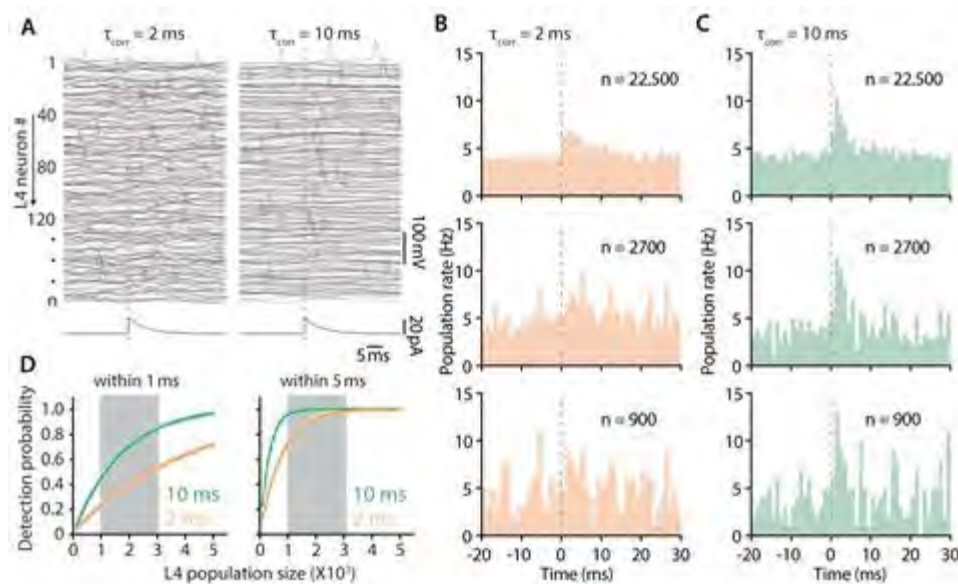

Slow noise in L4 improves the decoding performance. (A) Experimental paradigm for testing L4 population decoding. A single, extra presynaptic spike (aEPSC), embedded in either fast noise (left) or slow noise (right), was injected into a population of n L4 excitatory neurons. Example voltage waveforms are shown, note how the different noise timescales dominate the subthreshold fluctuations. (B) Example peri-stimulus time histograms plotted for fast noise, for population size n of 22,500, 2,700 and 900 (top to bottom). As population size decreases, signal saliency is reduced (pooled from $n = 23$ L4 neurons). (C) As B, but for slow noise. The EPSC-induced rate increase is locked much more tightly to the stimulus time. (D) The effect of synaptic noise correlation time and population

size on the probability of detecting the single EPSC input within 1 ms (left) and 5 ms (right). Circles denote the data points derived from the data in B and C, and solid lines denote exponential fits. The shaded range of population sizes indicates the approximate number of excitatory cells in layer 4 of a single barrel in rat cortex.

Network synchrony creates neural filters that switch brain state from navigation to sleep in *Drosophila*

Raquel Suárez Grimalt^{1,2}, Davide Raccuglia¹, Laura Krumm^{2,4}, Cedric C. Brodersen¹, Anatoli Ender¹, Sridhar Jagannathan¹, York Winter^{2,5}, Genevieve Yvon-Durocher^{1,2}, Richard Kempter^{2,4,6}, Jörg R.P. Geiger^{1,2}, David Oswald^{1,2,3}

¹Institute of Neurophysiology, Charité Universitätsmedizin Berlin, Charitéplatz 1, 10117 Berlin, Germany

²Einstein Center for Neurosciences Berlin, Charitéplatz 1, 10117 Berlin, Germany

³NeuroCure, Charité – Universitätsmedizin Berlin, Charitéplatz 1, 10117 Berlin, Germany

⁴Institute for Theoretical Biology, Department of Biology, Humboldt-Universität zu Berlin, Philippstr. 13, 10115 Berlin, Germany

⁵Institute of Biology, Department of Biology, Humboldt-Universität zu Berlin, Philippstr. 13, 10115 Berlin, Germany

⁶Bernstein Center for Computational Neuroscience Berlin, Philippstr. 13, 10115 Berlin, Germany

All animals require undisturbed periods of rest in which they undergo recuperative processes. However, it is currently unclear how quiescent brain states arise that are able to dissociate an animal from its external world, while retaining vigilance to salient sensory cues. Here, we describe a neural mechanism in *Drosophila* that creates neural filters that engender a quiescent brain state by generating coherent slow-wave activity (SWA) between R5 sleep-need and locomotion-promoting neural networks. Emergence of coherent activity is under circadian control and arises through interactions with the *Drosophila* sleep homeostat. Optogenetic mimicry of coherent activity reveals that temporally fine-tuned R5 oscillations reduce responsiveness to visual stimuli by rhythmically associating neural activity of locomotion-promoting cells, effectively overruling their output. On a circuit level, we find that these two networks bidirectionally regulate behavioral responsiveness by providing antagonistic inputs to downstream head direction cells. Thus, coherent oscillations provide the mechanistic basis for neural filters by temporally associating opposing signals resulting in reduced functional connectivity between locomotion-gating and navigational networks. We propose that the temporal pattern of SWA provides the structure to create a 'breakable' filter, allowing strong or salient stimuli to 'break' the neural interaction and, in contrast to comatose states, allow the animal to wake up, while maintaining body posture.

Neural integration of sensory input and sleep need in *Drosophila*

Cedric Beat Brodersen¹, Raquel Suárez-Grimalt^{1,2}, Jörg RP Geiger^{1,2}, David Oswald^{1,2,3},
Davide Raccuglia¹

¹Charité - Universitätsmedizin Berlin, Department of Neurophysiology, Charitéplatz 1, 10117 Berlin, Germany

²Einstein Center for Neurosciences Berlin, Charitéplatz 1, 10117 Berlin, Germany

³NeuroCure, Charité – Universitätsmedizin Berlin, corporate member of Freie Universität Berlin, Humboldt-Universität zu Berlin and Berlin Institute of Health, Charitéplatz 1, 10117 Berlin, Germany

Beside the circadian cycle, many other external and intrinsic factors affect sleep need as well as our subjective tiredness. How cognitive effort associated with sensory processing is integrated within the brain to accumulate sleep need is unknown. Here, we investigate how the Helicon cells, a neural population that processes visual information, affect the neural representation of sleep need within the brain of *Drosophila*. While acute activation of the Helicon cells gates locomotion, a permanent block of synaptic output counterintuitively reduces sleep and promotes vigilance, suggesting that compounded activity from these neurons indeed contribute to the fly's sleep need. Combining optogenetics with voltage and Ca²⁺ imaging, we demonstrate that the Helicon cells have differential functional connectivities to sleep and wake regulating neural networks. Furthermore, we provide preliminary evidence suggesting that hyperpolarization and synaptic output in Helicon cells are linked, pinpointing to specific molecular players that integrate cognitive effort to accumulate sleep need by interacting with sleep regulating circuits.

Olfactory dysfunction contributes to impaired developmental hippocampal-prefrontal activity in a mouse model of neuropsychiatric disorders

Fiona Parbst¹, Sebastian H. Bitzenhofer¹, Ileana L. Hanganu-Opatz¹

¹ Institute of Developmental Neurophysiology, Center for Molecular Neurobiology, University Medical Center Hamburg-Eppendorf, 20251 Hamburg, Germany

Cognitive deficits represent a major societal and individual burden of neuropsychiatric disorders. They result from abnormal hippocampal-prefrontal communication that has been hypothesized to emerge early in life, long before the disease symptoms are detectable. Studies in mouse models of these disorders confirmed the developmental network dysfunction and identified the impaired drive from the lateral entorhinal cortex (LEC) as the source of hippocampal-prefrontal deficits. We previously showed that already early in life, when other senses are still poorly developed, olfactory inputs and endogenously-generated activity in the olfactory bulb boost the LEC. The contribution of the olfactory system to the developmental network dysfunction and cognitive impairment in neuropsychiatric disorders is fully unknown, despite experimental evidence of substantial olfactory deficits in patients. Here, we address this knowledge gap by combining behavioral assessment in an odor learning task with simultaneous recordings of local field potential and neuronal firing from the olfactory bulb, hippocampus, and prefrontal cortex in postnatal day (P) 8 to 10 immune-challenged *Disc1*^{+/-} mice. We found that odor-evoked activity is impaired in these mice, resulting in a reduced olfactory drive of the hippocampal-prefrontal network and, ultimately, in impaired odor learning. These findings indicate that early olfactory dysfunction might contribute to the impaired prefrontal-hippocampal development in neuropsychiatric disorders.

Peptidergic and aminergic modulation of Insulin-Producing Cells in *Drosophila*

Martina Held¹, Isabella Balles¹, Rituja Bisen¹, Selina Hilpert¹, Alexander S. Chockley¹, Federico Cascino-Milani¹, Sander Liessem¹, Meet Zandawala¹, Jan M. Ache¹

¹ Neurobiology and Genetics, Theodor-Boveri-Institute, Biocenter, Julius-Maximilians-University of Würzburg, Würzburg, Germany

Insulin plays a key role in regulating crucial bodily functions such as growth, reproduction, aging, and most prominently metabolic homeostasis across the animal kingdom. In *Drosophila melanogaster*, insulin is released by 14 insulin-producing cells (IPCs), located in a central modulatory region of the brain. Since insulin plays such an important role in a variety of processes, IPC activity needs to be adjusted, to ever-changing internal demands. This is achieved by inputs from modulatory neurons impinging on the IPC population. Here, we capitalized on the powerful genetic toolkit available in *Drosophila* to characterize the modulation of IPCs *in-vivo*. First, we recorded IPC activity using *in-vivo* calcium imaging and found several clusters in the IPC population, defined by synchronized neuronal activity within each cluster but asynchronous activity between clusters. To investigate how these clusters arise and how IPC activity is regulated in general, we optogenetically activated eleven different peptideric and aminergic neuron populations, implicated in IPC modulation. Simultaneous recordings of individual IPC activity via *in-vivo* whole cell patch-clamp revealed excitatory as well as inhibitory inputs. Interestingly, activating certain upstream neuron populations during calcium imaging unveiled heterogeneous effects on the IPC population. We then used RNA sequencing and anatomical approaches to investigate whether these heterogeneous effects could potentially originate from differences in the receptor expression across IPCs for the tested inputs. Taken together, by characterizing a broad spectrum of inputs alongside receptor expression data, we were able to identify heterogeneous functional inputs to the IPCs. These heterogeneous inputs could in turn be responsible for the clusters we found in the IPC population activity, adding another layer of complexity to the modulation of IPCs. Moreover, our approaches add new insights into how insulin release is regulated to adapt vital bodily functions to ever-changing internal demands and circumstances.

Syntalos: A Software for simultaneous acquisition of heterogeneous neurophysiological data and for closed-loop intervention protocols

Matthias Klumpp¹, Lee Embray¹, Justus Simon¹, Andreas Draguhn¹, Martin Both¹

¹Universität Heidelberg, Institut f. Physiologie u. Pathophysiologie, AG Both, Im Neuenheimer Feld 326, 69120 Heidelberg, Germany

Many experiments rely on the acquisition of heterogeneous data from a variety of different sources, making accurately aligned timestamps a key requirement. In addition, it is often necessary to manipulate experimental settings on the fly, especially *in vivo* where interventions depend on the animal's state or behavior. Finally, acquired data should be stored in a standardized format to simplify subsequent analysis. Software packages supporting these requirements should be readily available, easy to handle and versatile enough to allow setting up new data acquisition pipelines without much effort.

To address these requirements, we developed a new, integrated software solution capable of simultaneous acquisition of data from an arbitrary amount of sources of different kinds, e.g. multi-channel electrophysiological recordings, conventional video images, high-speed camera data, serial interfaces or Miniscopes. The software, called Syntalos, ensures aligned timestamps for all inputs, and makes use of the parallel-processing capabilities of modern CPUs to effectively run many tasks simultaneously. New data sources can be integrated and adjusted with minimal programming skills. For more advanced applications, the modular software design facilitates extension with new modules written in either C/C++ or Python.

All data generated from a given experiment is stored in a well-defined, comprehensive structure, making it easy to compare, pool or share data between experimentalists with different research questions.

With these abilities, Syntalos enables reliable closed-loop experiments for many different (neuro)scientific questions. Tests with diverse research questions, experimental setups and laboratories show the good performance and easy-to-learn structure of the program. In particular, it has been tested in an experiment to map neuron morphology and activity to behavior using Miniscopes and imaging techniques.

The anatomy of auditory brainstem nuclei in the Etruscan shrew

Alina C. Zacher¹, Felix Felmy¹

¹Institute for Zoology, University of Veterinary Medicine Hannover, Germany

Original mammals are supposed to have small head sizes and predominantly high frequency listeners with limited frequency resolution. The Etruscan shrew (*Suncus etruscus*), a recent mammal likely approximates these ancestral conditions. Moreover, the Etruscan shrew's middle ear bone seems to be shaped in an original mammalian fashion. Thus, the smallest terrestrial mammal might be a suitable model organism for the original mammalian auditory system. So far, the central auditory system of the Etruscan shrew is largely unexplored. Therefore, we investigated the anatomical features of the lower auditory brainstem pathways of the superior olivary complex (SOC), the lateral lemniscus (LL) and the inferior colliculus (IC).

By means of Nissl and immunofluorescence labelling, we identified the position, input pattern, calcium binding proteins, inhibitory transmitter types and hyperpolarising cation channels (HCN1) expression in the major nuclei of the SOC, the LL and the IC. Our Nissl staining indicated the well-known gross anatomy of the SOC where the medial nucleus of the trapezoid body (MNTB), the lateral nucleus of the trapezoid body (LNTB), the lateral superior olive (LSO), the superior paraolivary nucleus (SPN) were readily identified. A clear outline of the medial superior olive (MSO) was not apparent. In the LL the ventral (VNLL), intermediate (INLL) and dorsal nucleus (DNLL) and in the IC the central nucleus could be addressed. Synaptic excitation and inhibition marked by VGluT1 and GlyT2 labelling respectively, selective presence of HCN1 immunofluorescence and the distribution of GABAergic and glycinergic labelling supported the identification of most nuclei. Calcium binding protein expression was sparse and many neurons appeared to lack the expression of the three standard proteins Parvalbumin, Calretinin and Calbindin, despite their presence e.g. in the cerebellum. None of the used markers was sufficient to identify the MSO unambiguously.

Our work corroborates the high conservation of the auditory brainstem structures. The lack of an identifiable MSO indicates that Etruscan shrews are predominantly high frequency listeners but unlike bats have not adapted this structure for other functions. The distribution of functional markers for synaptic inputs, transmitters and ion channels matches these in rodents, while the low expression pattern of calcium binding proteins remains enigmatic.

Poster Topic

T24: Attention, Motivation, Emotion and Cognition

- [T24-1A](#) Computational archaeology of the human cognitive past
Wulf Haubensak, Joanna Kaczanowska, Florian Ganglberger, Olga Chernomor, Dominic Kargl, Andreas Hess, Yoshan Moodley, Arndt von Haeseler, Katja Bühler, Lukasz Piszczek
- [T24-2A](#) Decision-making based on visual motion perception in the crow
Philipp Schmidbauer, Andreas Nieder
- [T24-3A](#) Developmental dynamics of cognitive flexibility in mice
Mariia Dorofeikova, Jastyn A. Pöpplau, Ann M. Thies, Ileana L. Hanganu-Opatz
- [T24-4A](#) Effects of altered *Ribosomal S6 kinase (RSK/S6kII)* expression on emotion-relevant open-field behavior of *Drosophila melanogaster*
Yi Wang, Maria Steigmeier, Yasmine Zöller, Thomas Raabe, Christian Wegener
- [T24-5A](#) Exogenous and endogenous spatial attention in crows
Linus Hahner, Malte Quest, Paul Rinnert, Andreas Nieder
- [T24-6A](#) Frontopolar mechanisms for driving social and economic decisions in primate groups
Raymundo Báez Mendoza, Emma P Mastrobattista, Amy J Wang, Ziv M Williams
- [T24-7A](#) Heterogeneity of excitatory neurons of the basolateral amygdala: from transcriptome to calcium imaging and behavior
hansol lim, Christian Peters, Ruediger Klein
- [T24-1B](#) Hunger state-dependent modulation of neural processing and behavior in *Drosophila* larvae
Katrin Vogt
- [T24-2B](#) Mapping of the Carrion Crow's Brain
Ylva Kersten, Felix Moll, Saskia Erdle, Bettina Friedrich-Mueller, Andreas Nieder
- [T24-3B](#) Modality-specific accumulation of evidence in mice performing a multisensory discrimination task
Gerion Nabbefeld, Emma Cravo, Irene Lenzi, Sacha Abou Rachid, Severin Graff, Simon Musall, Björn Kampa
- [T24-4B](#) Negative and positive stimuli in the Open-field test behaviour of *Drosophila melanogaster*
Emilia Derksen, Yi Wang, Christian Wegener

- [T24-5B](#) Neural mechanisms of numerical selection in the fronto-parietal cortices of the macaque
Tobias Machts, Julia Grüb, Andreas Nieder
- [T24-6B](#) Number production in rhesus macaques
Laura Elisa Seidler, Stephanie Westendorff, Andreas Nieder
- [T24-7B](#) Orthogonal coding of food and voluntary exercise by VTA dopamine neurons
Hanna Elin van den Munkhof, Vasyl Mykytiuk, Tatiana Korotkova
- [T24-1C](#) Prefrontal cortex tracks elapsed time during self-paced action selection
Ole Christian Sylte, Hannah Muysers, Hung-Ling Chen, Marlene Bartos, Jonas-Frederic Sauer
- [T24-2C](#) Real-time whistle pitch-matching in wild nightingales
Giacomo Costalunga, Daniela Vallentin
- [T24-3C](#) Selective attention in the highspeed decisions of hunting archerfish
Sophie Yvonne Schödel, Martin Krause, Wolfram Schulze, Stefan Schuster
- [T24-4C](#) Social odour activates the hippocampal formation in zebra finches (*Taeniopygia guttata*)
Uwe Mayer
- [T24-5C](#) Spatial coding by somatostatin and neurotensin neurons in the lateral septum
Robson Scheffer Teixeira, Francisco Javier de los Santos Bernal, Letizia Moscato, Tatiana Korotkova
- [T24-6C](#) The reverse cocktail party problem: Dynamic time-domain jamming avoidance in freely socializing bats
Ava Kiai, Manfred Koessl, David Poeppel, Julio Hechavarria

Computational archaeology of the human cognitive past

Wulf Haubensak^{1,6}, Joanna Kaczanowska¹, Florian Ganglberger², Olga Chernomor³,
Dominic Kargl^{1,6}, Andreas Hess⁴, Yoshan Moodley⁵, Arndt von Haeseler³, Katja Bühler²,
Lukasz Piszczek^{1,6}

¹Research Institute of Molecular Pathology (IMP), Vienna Biocenter (VBC), Campus-Vienna-Biocenter 1, 1030 Vienna, Austria

²VRVis Research Center, Donau-City Strasse 11, 1220 Vienna, Austria

³Center for Integrative Bioinformatics Vienna (CIBIV), Max Perutz Labs, University of Vienna, Medical University of Vienna, Dr. Bohr Gasse 9, 1030 Vienna, Austria

⁴Institute of Experimental and Clinical Pharmacology and Toxicology, Friedrich-Alexander University Erlangen-Nuremberg, Fahrstrasse 17, 91054 Erlangen, Germany

⁵Department of Zoology, University of Venda, Private Bag X5050, Thohoyandou, Republic of South Africa

⁶Department of Neuronal Cell Biology, Center for Brain Research, Medical University of Vienna, Vienna, Austria

Our human identity emerged from multigenic events across brain networks over 61 My of primate evolution. However, these processes acted in brains of ancient ancestors, which are inaccessible to in-depth exploration. Here, we reasoned that by combining genomic and functional brain data we would overcome this challenge. We calculated genome-wide substitution rates in coding sequences (dN/dS ratios) in sets of chronologically ordered mammalian species from mouse to modern humans. We find that neutral and positive selection in functional networks (FNs) was associated with excitatory neurons and synaptic function and correlated with FNs from task-evoked functional MRI and functional neuroanatomy. Additionally, this temporo-spatial atlas revealed early neurogenetic selection of basic cognition and recent evolution of higher cognitive functions in primates. Importantly, this approach allowed to impute functional features of archaic brains from extinct hominin genomes. These data predict a peak for accelerated neurogenetic selection for language and verbal communication in an early hominin ancestor (7.4-1.7 Mya). In recent hominin evolution, strategic thinking together with language emerged as the dominant traits that separated archaic Denisovan and Neanderthal hominins from modern humans (0.8 Mya – present). These periods were interspersed with adaptative selection of social networks (e.g., 26-19 Mya, 7.4 Mya, 0.8 My – present), suggesting partially convergent evolution of socio-affective and higher cognitive traits in the course of primate history. In summary, fusing paleogenomics with brain data allows to reconstruct cognitive traits in archaic brains in silico and difficult to access by any other means.

Decision-making based on visual motion perception in the crow

Philipp Schmidbauer¹, Andreas Nieder¹

¹Animal Physiology, Institute of Neurobiology, University of Tübingen, Auf der Morgenstelle 28, 72076 Tübingen, Germany

The formation of decisions based on sensory information is fundamental to complex behavior. During perceptual decision-making, evidence for different alternatives is accumulated over time. When the amount of sampled information for one alternative reaches a decision threshold, the corresponding action will be initiated. The psychophysical and neuronal characteristics of perceptual decision-making have been intensively investigated in non-human primates. Here, a classic motion direction-discrimination task in which the subject has to discriminate the global motion direction in a visual random dot motion stimulus, laid the foundation for our understanding of how the integration of sensory information leads to a decision.

To directly compare the process of decision formation in mammals to a non-mammalian vertebrate, we trained carrion crows (*Corvus corone*) to perform in a perceptual decision-making task. Following classical primate studies, the crows were trained to discriminate the global motion direction in random dot motion stimuli of varying motion strength. To investigate how the decision-making process adapts to an increase in possible outcomes of the decision, the crows were prompted to discriminate either between two or four possible motion directions. Psychometric functions showed that the crows were proficient in discriminating stimuli with high motion strength but were also able to discriminate stimuli containing low amounts of motion information above chance level. An increase in the number of possible motion directions from two to four reduced discrimination performance. Compared to non human primates, the reaction times of the crows were shorter and less influenced by motion strength or the number of possible motion directions. Establishing the motion direction-discrimination task in the carrion crow provides the opportunity to directly compare the neuronal basis of perceptual decision-making in the avian brain to the convergently evolved mammalian neocortex.

Developmental dynamics of cognitive flexibility in mice

Mariia Dorofeikova¹, Jastyn A. Pöpplau¹, Ann M. Thies¹, Ileana L. Hanganu-Opatz¹

¹Institute of Developmental Neurophysiology, Center for Molecular Neurobiology, University Medical Center Hamburg-Eppendorf, Hamburg, Germany

Cognitive flexibility encompasses executive functions essential for successful survival in a dynamic environment. These higher-order cognitive abilities, such as working-memory (WM) and decision-making (DM), emerge late in life, yet their onset and age-dependent dynamics are poorly understood. To elucidate the developmental trajectories of WM and DM, we monitored mice from postnatal day (P) 17 until adulthood (P60) in a one-day version of digging-based four-choice odor discrimination and set-shifting tasks as well as non-matched-to-sample task in a Y-maze. The behavioral investigation was complemented by post-mortem cFos staining to assess the level of task-dependent neuronal activation. We found that juvenile mice (P23-34) had the shortest latency to dig in the four-choice odor discrimination task when compared with pre-juvenile and adult animals. This fast choice might reflect a higher DM ability at this age. Social status affected the set-shifting parameters with intermediate-ranked mice having the largest number of novel errors. The WM emerged during late development and the performance augmented with age. The behavioral dynamics related to cFos expression changes detected in cortical and subcortical areas. These results reveal distinct developmental trajectories for WM and DM. Whereas DM follows a non-linear development with a peak around P28, WM emerged towards the end of development and linearly progressed until adulthood.

Funded by the DFG (FOR5159).

Effects of altered *Ribosomal S6 kinase (RSK/S6kII)* expression on emotion-relevant open-field behavior of *Drosophila melanogaster*

Yi Wang¹, Maria Steigmeier¹, Yasmine Zöller¹, Thomas Raabe², Christian Wegener¹

¹Neurobiology and Genetics, Würzburg Insect Research, Biocenter, University of Würzburg, Germany

²Medical Radiation and Cell Research, Biocenter, University of Würzburg, Germany

Coffin-Lowry syndrome is a rare genetic disorder with a major character of severe mental retardation. This disorder is caused by a *Ribosomal S6 Kinase 2 (RSK2)* mutation on the X chromosome in humans. The pathophysiology is however not well understood. *RSK2*⁻ mice and *Drosophila RSK*⁻ mutants show various forms of learning deficits.

By establishing an open field test (OFT) in *Drosophila melanogaster*, we can assess “emotion-like” behavior in a quantitative manner by measuring the distance to the center of wall following behavior (WAFO) and total walk distance (TOWA). Here we tested whether *RSK*⁻ flies show an altered phenotype in the OFT.

We found that the loss of function of *RSK* in the *RSK*⁻ mutant fruit fly causes a lower score in WAFO and TOWA, which is inconsistent to the rodent study. In order to confirm and understand the involvement of *RSK* in affecting “emotion-like” behavior that we observed in the *RSK*⁻ mutant fruit fly, we try to identify relevant neuronal circuits by a targeted RNAi screen and CRISPR-Cas9-mediated knockout of *RSK*. This study will enhance our understanding of the brain function of *RSK* in “emotion-like” behavior and mental deficits.

Funded by the Deutsche Forschungsgemeinschaft
(DFG WE 2652/9-1)

Exogenous and endogenous spatial attention in crows

Linus Hahner¹, Malte Quest¹, Paul Rinnert¹, Andreas Nieder¹

¹ Animal Physiology Unit, Institute of Neurobiology, Auf der Morgenstelle 28, University of Tübingen, 72076 Tübingen, Germany

Attention describes the ability to selectively process a particular aspect of the environment at the expense of others. Despite the significance of selective processing, the types and scopes of attentional mechanisms in non-primate species remain underexplored. We trained carrion crows in Posner spatial cueing tasks using two separate protocols where the attention-capturing cues are shown at different times before target onset at either the same or a different location as the impending peripheral target. The variable delay between cue onset and target onset, the stimulus onset asynchrony (SOA), allowed to explore the time course of attention effects. To probe automatic bottom-up, or exogenous, attention, two naïve crows were tested with a cue that had no predictive value concerning the location of the subsequent target. Comparing the performance for valid (cue and target at same location) and invalid (cue and target at opposite locations) cues in the non-predictive cue condition showed a reaction time advantage at an SOA of 400 ms that signified exogenous attention in both crows. To examine volitional top-down, or endogenous, attention, four crows were tested with previously learned cues that predicted the impending target location. In this predictive cue task, the crows showed strong and long-lasting RT advantages to valid cues from 200 ms SOA up to the longest tested SOA of 1600 ms. With a reaction time advantage of 30 ms in the predictive cue protocol relative to the non-predictive cue protocol, the magnitude of the attention effect in crows was comparable to attention effects of macaques. In sum, our results show that both exogenous and endogenous attention mechanisms are present in crows and that crows can employ flexible cognitive control over attention allocation. Our findings in crows therefore contradict the hypothesis that neocortical circuitry is indispensable for endogenous attention in all vertebrates. Rather, it suggests that overarching anatomical and physiological principles of the telencephalic pallium offer this structure as a substrate for endogenous attention to evolve independently across vertebrate phylogeny.

Frontopolar mechanisms for driving social and economic decisions in primate groups

Raymundo Báez Mendoza^{1,2}, Emma P Mastrobattista², Amy J Wang², Ziv M Williams²

¹German Primate Center, Social Neurobiology Lab, Göttingen, Germany

²Harvard Medical School, Boston, USA

Primate group behavior allows individuals to build affiliations and benefit from the reciprocation with others but also poses the unique challenge of tracking others' behavior across multiple distinct interactions. These interactions can often also be highly dynamical and change rapidly based on the reputation or wealth distribution of others. The single-cellular mechanisms that precisely underlie these decisions or that drive the social-economic behavior of groups, however, remain poorly understood. Here, we obtained multiple-neuronal recordings from the dorsomedial prefrontal cortex (dmPFC) and frontopolar (FP) cortex of Rhesus macaques as they performed a structured reciprocity-based social task. In this task three individuals interacted with each other over multiple rounds by offering each other reward and which could allow us to dissociate computations associated with interactive behavior, social preference, and group dynamics. Behaviorally, we find that the monkeys demonstrated a strategic preference for other individuals and favored rewarding those who reciprocated. The rate at which individuals reciprocated within and across sessions was reflected in distinct levels of reputation. At the single-cellular level, we have previously shown that different subpopulations of dmPFC neurons tracked the identity of the current actor and reward recipient. Here, we show that the activity of a subpopulation of FP neurons correlated with the current actor's own reputation for reciprocity. These findings reveal neurons in the primate prefrontal cortex that encode information about specific individuals within social groups and which could help optimize economic benefit during interactive group dynamics. Future work in Macaques and Marmosets will expand on how social ties impinge on these economic behaviors and their neuronal mechanisms.

Heterogeneity of excitatory neurons of the basolateral amygdala: from transcriptome to calcium imaging and behavior

hansol lim¹, Christian Peters¹, Ruediger Klein¹

¹Max Planck institute for Biological intelligence, Ruediger Klein dept, Am Klopferspitz 18, 82151 planegg, Germany

The basolateral amygdala (BLA) integrates emotional, social and metabolic information to participate in a variety of defensive and appetitive behaviors. The circuit mechanisms by which the BLA mediates these different functions are poorly understood. One important aspect is the heterogeneity of excitatory neurons of the BLA. On the one hand, BLA neurons have shown a high degree of heterogeneity that varies in transcriptome, physiology and circuit properties. Genetically distinct BLA populations were found to respond to negative and positive valence stimuli, respectively, and to control the respective behaviors. On the other hand, BLA neurons can be recruited from the same population into active ensembles during different kinds of explorative behaviors, suggesting e.g. that the BLA encodes social exploration behavior in a valence-independent manner. In our study, we have combined single cell transcriptomics to identify heterogeneities among excitatory BLA neurons, with multi fluorescent in situ hybridization to map cell types to subregions of the BLA. We then selected a small number of Cre transgenic lines representing distinct BLA cell types and performed deep brain calcium imaging in response to appetitive and aversive stimuli. Finally, we used optogenetics to manipulate these BLA cell types to modulate valence-specific behavior. Our preliminary results suggest that excitatory neurons of the BLA consist of heterogeneous subpopulations that are organized in space, and are involved in valence-specific behaviors. Two populations of the anterior BA are involved in aversive behaviors, whereas one population of the posterior BA is involved in appetitive behaviors.

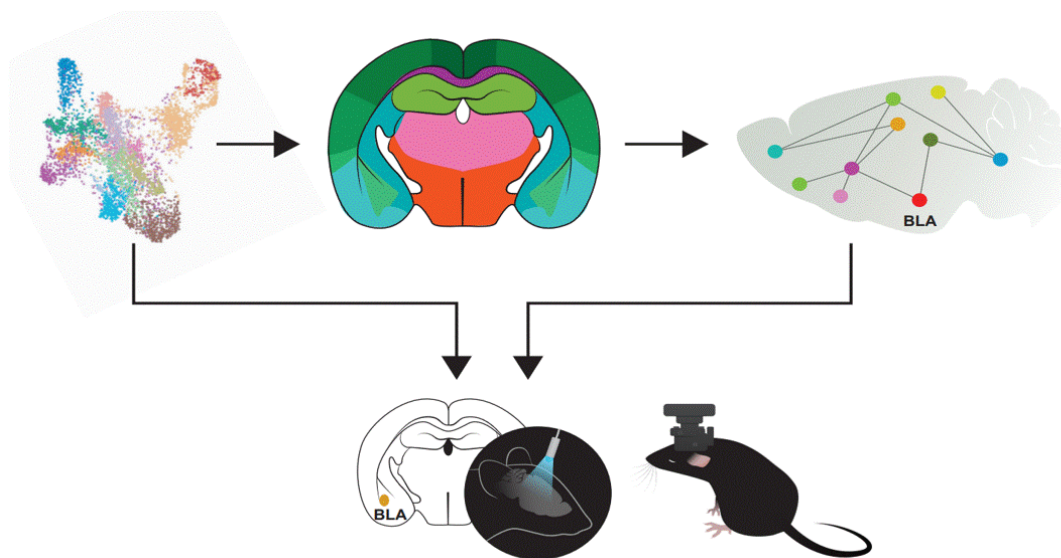

Hunger state-dependent modulation of neural processing and behavior in *Drosophila* larvae

Katrin Vogt^{1,2}

¹University of Konstanz, Biology, Universitätsstrasse 10, 78464 Konstanz, Germany

²Centre for the Advanced Study of Collective Behaviour, Universitätsstrasse 10, 78464 Konstanz, Germany

Making flexible and appropriate foraging decisions is crucial for all animals, especially when facing starvation. Olfactory information is essential to evaluate food quality before ingestion, and previously we found that *Drosophila* larvae switch their odor response from aversion to attraction when food deprived. Such flexibility allows for broader exploration behavior when foraging. We now investigate if such a change in the internal state also influences other behavioral decisions. It has been shown that fly larvae can feed on other conspecifics. We tested fed and food-deprived larvae in a cannibalism setup, to investigate the effect of food deprivation on feeding on dead conspecifics. We find that fed fly larvae rarely use dead conspecifics as a food source. However, food deprivation enhances feeding on conspecifics. Fly larvae also show enhanced feeding when they were allowed to feed on fructose before the test, being in a purely protein-deprived state. State-dependent modulation of olfactory preference requires an intact olfactory sensory system and serotonergic signaling. We will now also investigate the underlying neural mechanisms that mediate the enhanced preference for feeding on dead conspecifics.

Mapping of the Carrion Crow's Brain

Ylva Kersten¹, Felix Moll¹, Saskia Erdle¹, Bettina Friedrich-Mueller¹, Andreas Nieder¹

¹University of Tübingen, Animal Physiology, Institute of Neurobiology, Auf der Morgenstelle 28, 72076 Tübingen, Germany

Corvidae, passerine songbirds such as jays, crows and ravens known as corvids, have become model systems for the study of avian cognition. The superior cognitive capabilities of corvids mainly emerge from a disproportionately large telencephalon found in these species. However, a systematic mapping of the neuroanatomy of the corvid brain, and the telencephalon in particular, is lacking so far. Here, we present our studies on the overall anatomy and anatomical connections of the carrion crow brain, *Corvus corone*, with a special focus on the telencephalic pallium. First, we applied different basic staining techniques to brain slices (Nissl, myelin, combination of Nissl-and-myelin, and tyrosine hydroxylase targeting catecholaminergic neurons). This allowed us to identify brain nuclei and different pallial subdivisions throughout the brain. The extent of these subdivisions and brain nuclei are described according to stereotaxic coordinates. While the overall organization of the carrion crow's brain matches other songbird brains, the relative proportions and expansions of associative pallial areas differed considerably in agreement with the enhanced cognitive skills found in corvids. An important hub for executive function in birds is the nidopallium caudolaterale (NCL), which is thought to be the functional equivalent of the mammalian prefrontal cortex (PFC). Based on the stereotaxic coordinates from our atlas, we injected an anterograde tracer (Dextran) into the dorsal portion of NCL (NCLd) to determine its major output connections. We found strong, heterogeneous terminal fields within the arcopallium, the major source of descending sensory and motor projections in the avian brain. Our atlas, along with a growing connectivity map of the crow brain will enable future functional studies in this fascinating species.

Modality-specific accumulation of evidence in mice performing a multisensory discrimination task

Gerion Nabbefeld^{1,2}, Emma Cravo³, Irene Lenzi^{2,3}, Sacha Abou Rachid^{1,2}, Severin Graff^{1,2,3}, Simon Musall^{2,3}, Björn Kampa^{1,2,4}

¹Department of Neurophysiology, Institute of Biology II, RWTH Aachen University, Aachen, Germany ²Research Training Group 2416 MultiSenses – MultiScales, RWTH Aachen University, Aachen, Germany ³Institute of Biological Information Processing (IBI-3), Forschungszentrum Jülich, Jülich, Germany ⁴JARA BRAIN, Institute of Neuroscience and Medicine (INM-10), Forschungszentrum Jülich, Jülich, Germany

Much effort has focused on studying how the brain processes information from individual senses. Yet, the neural mechanisms that allow for multimodal integration aren't well understood. To study how neural circuits integrate visual and tactile information, we developed a multisensory discrimination task for head-fixed mice. Here, sequences of visual, tactile or visuotactile stimuli are presented on both sides of the mouse. After a short delay the mouse has to indicate the side with the higher stimulus rate to obtain a water reward. Mice achieved high accuracy in all conditions, with improved performance in multisensory trials.

Using widefield-imaging, we measured cortex-wide activity in transgenic mice, expressing the Ca²⁺-indicator GCaMP6s in excitatory neurons. Multisensory stimuli evoked higher neuronal activity compared to unisensory stimulation, particularly in the rostromedial association area RL and the medial frontal cortex (mFC). To better isolate sensory responses we used a linear encoding model. Including a multisensory interaction term explained significantly more information than unisensory regressors alone, especially in parietal and frontal areas. This suggests that cortical multisensory responses are not simply a linear summation of unisensory responses.

To causally test the relation between cortical activity and perceptual decisions, we used the inhibitory opsin stGtACR2 to silence excitatory neurons in RL and mFC at different times during the task. Inhibiting mFC during the delay resulted in robust impairments in all conditions, whereas inactivating RL mainly affected visual performance, despite robust multisensory activity.

Our results show distributed cortical sensory processing and a convergence of sensory streams in mFC guiding behavior.

Negative and positive stimuli in the Open-field test behaviour of *Drosophila melanogaster*

Emilia Derksen¹, Yi Wang¹, Christian Wegener¹

¹University of Würzburg, Neurobiology and Genetics, Germany

The Open-field test (OFT) is widely used to assess locomotor activity, anxiety and exploratory behaviour in rodents. We recently reported evidence that the OFT can be used to assess emotion-like states in the fruit fly, *Drosophila melanogaster* (1). Our goal here was to extend our characterisation of OFT behaviour in fruit flies, focussing on positive and negative stimuli.

Fly locomotor activity was automatically tracked and differences in wall-following (WAFO) and total walking distance (TOWA) were assessed dependent on age, mating status, and sex of CantonS wildtype flies. Electric foot shocks (EFS) were tested as an aversive stimulus, while ethanol and diazepam treatment and manipulation of serotonin transporter (SerT) levels served as positive stimuli.

Our results show that age, sex and mating status affect OFT behaviour. In general, positive stimuli decrease WAFO and TOWA, while negative stimuli have the opposite effect. Interestingly, both conditional SerT overexpression, as well as downregulation, reduces WAFO and TOWA compared to controls. This effect persists after prior EFS exposure.

In summary, our results provide further support to the notion that the simple OFT can be used to assess emotion-like states in *Drosophila*.

(1) Wang et al., Neurofly 2022 St. Malo

Funded by the Deutsche Forschungsgemeinschaft (DFG WE 2652/9-1)

Neural mechanisms of numerical selection in the fronto-parietal cortices of the macaque

Tobias Machts¹, Julia Grüb¹, Andreas Nieder¹

¹Animal Physiology, Institute of Neurobiology, Eberhard-Karls-Universität Tübingen, Auf der Morgenstelle 28, 72076 Tübingen, Germany

Cognitive control is needed to regulate interactions between brain areas to generate purposeful behavior. The prefrontal cortex (PFC) and posterior parietal cortex are key brain areas for cognitive control but also for numerical representations. If and how numerosity-selective cells change their tuning after a presentation of a sequence of other nonmatching numerosities is unclear. We trained two macaque monkeys on a modified version of the delayed match-to-numerosity task in which the monkeys had to match numerosities to sample numerosities (1 – 4). Non-matching numerosities that were presented between sample and matching test stimulus had to be ignored. Up to three sequential numerical non-matches were presented, i.e. the task consisted of up to three test phases and in each test phase the right or wrong numerosity could occur. After the monkeys mastered the task, we simultaneously recorded single-unit activity from PFC and the intraparietal sulcus (IPS). In both brain areas we found cells that exclusively encode the presented numerosities (determined by an ANOVA with the trial-by-trial firing rates in the sample period). For each of these numerosity-selective neurons we determined the individual tuning in the sample period. Next, we tested with tuning curve cross-correlations how this initial tuning changed when a match numerosity was presented in the sequence of test numerosities (match numerosity was equal to the sample numerosity). Surprisingly, PFC neurons kept their initial tuning stably over the three test phases, while neurons from the IPS exhibited increasingly deteriorated tuning with increasing test periods. This was confirmed by training and testing a support vector machine for the discrimination of numerosities during the match period on the spiking activity of the sample period. Our results suggest a privileged role for the PFC in coding and maintaining behaviorally relevant numerical information in light of irrelevant numerosities.

Number production in rhesus macaques

Laura Elisa Seidler¹, Stephanie Westendorff¹, Andreas Nieder¹

¹University of Tübingen, Institute of Neurobiology, Animal Physiology Unit, Auf der Morgenstelle 28, 72076 Tübingen, Germany

In recent years, evidence from several areas of research established that non-human animals possess numerical competence. This ability is of adaptive value in an ecological context. Such non-symbolic representation of numerosity in animals is approximate and based on an approximate number system that follows the regularities of the Weber-Fechner law. The main focus of numerical studies in animals so far was primarily directed towards the discrimination of sensory numerosities. However, there is evidence that animals are also able to produce specific numbers of movements and keep track of self-performed actions. In order to investigate the relationship between perceived numerosity and numbers of performed actions, two rhesus macaques were trained on a number production task. This task required the monkeys to produce as many handle releases as seen numbers of items in visual displays. The stimulus sets consisted either of arrays of dots ranging from one to five or Arabic numerals the monkeys had learned to associate with numerosities. The presented numerical values instructed the required number of counts the monkeys needed to perform. In the number production period following the instruction stimulus phase, each individual hand movement was cued while the inter-count intervals were controlled for temporal factors to eliminate possible action performance based on timing. The completion of each sequence of self-produced numbers of actions was indicated by the monkeys by performing a saccade as a concluding “enter” response. Both monkeys performed this task proficiently and with high accuracy. Behavioral performance showed that the production of numbers follows an approximate number representation and displayed the characteristics of the Weber law such as the numerical size and numerical distance effect. Logarithmic scaling of the behavioral tuning curves resulted in equal variance, indicating the principles of the Fechner law. Analysis of reaction times revealed no difference across timing protocols. Overall, the monkeys’ precision in this task was impressive and comparable to the one seen in humans asked to reproduce a target number with a series of fast key presses while being prevented from symbolic counting. The finding that the monkeys were able to properly reproduce visually instructed numbers one to five by self-generated hand movements shows that they can translate the number of sensed numerical information into the controlled number of self-generated actions.

Orthogonal coding of food and voluntary exercise by VTA dopamine neurons

Hanna Elin van den Munkhof^{1,2}, Vasyli Mykytiuk^{1,2}, Tatiana Korotkova^{1,2}

¹University of Cologne, Medical Faculty, Robert-Koch-Str. 39, 50931 Cologne, Germany

²Max Planck Institute for Metabolism Research, Gleueler Str. 50, 50931, Cologne, Germany

Adequate regulation of innate behaviours, including feeding and locomotion, is crucial for survival. The ventral tegmental area (VTA) forms the core of the neural circuitry driving these motivated behaviours. VTA dopamine neurons encode reward and reward-predicting cues, but not homogeneously. Moreover, separate neurons recently have been shown to respond to subsets of behavioural, kinematic and spatial variables. However, it remains unclear whether individual dopamine neurons distinguish between different reward types. In addition, it is unknown how changes in motivational state, such as enhanced drive for exercise or hunger, influence the responses of VTA dopamine neurons to rewards. Therefore, the aim of this study was to find out whether individual VTA dopamine neurons encode distinct reward types heterogeneously, and how motivational state affects their function.

We performed 1-photon calcium imaging in DAT-cre mice expressing GCaMP6m in the VTA, while they freely explored a paradigm with multiple rewards, including food, water, a conspecific, a running wheel and a novel object. To study the effects of increased drive for exercise and for feeding, calcium dynamics were additionally recorded in mice that were repeatedly exposed to a running wheel and during chronic food restriction. To assess the contribution of anatomically different subpopulation, food intake and locomotion was measured after optogenetically activating projection-specific VTA neurons.

We found that VTA dopamine neurons do not respond uniformly to distinct rewards, and especially encode food proximity and voluntary exercise in an orthogonal manner, with neurons excited by food proximity being inhibited in the running wheel and vice versa. Similarly, projections to different targets controlled feeding and locomotion in an opposite manner. During increased drive for exercise, the proportion of running wheel-excited neurons increased while the activity of these excited neurons simultaneously decreased. During chronic food restriction, the proportion of food-excited neurons increased, while the activity of these excited neurons did not change. Strikingly, the average activity of VTA dopamine neurons in the food and water zone increased, while the activity in all the other zones decreased, reflecting changes in the prioritization of different needs. These results suggest that VTA dopamine neuron subpopulations distinguish between different rewards and can shift their responses according to changes in motivational state.

We gratefully acknowledge support by the ERC Consolidator Grant (772994, FeedHypNet, to T.K.) and DFG (431549029–SFB1451 and EXC2030-CECAD, to T.K., 233886668-GRK1960, to V.M.).

Prefrontal cortex tracks elapsed time during self-paced action selection

Ole Christian Sylte^{1,2}, Hannah Muysers^{1,2}, Hung-Ling Chen¹, Marlene Bartos¹, Jonas-Frederic Sauer¹

¹Institute of Physiology I, Medical Faculty, Albert-Ludwigs-University Freiburg, Hermann-Herder-Straße 7, 79104 Freiburg, Germany

²Faculty of Biology, Albert-Ludwigs-University Freiburg, Schaezlestrasse 1, 79104 Freiburg, Germany

Intense threat elicits action in form of active and passive coping strategies. The medial prefrontal cortex (mPFC) is involved in behavioral responses to stress, but the dynamics of encoding stress-related behavioral strategies by mPFC neurons remain poorly understood. Here, we used 1-photon calcium imaging to record large populations of layer 5 mPFC pyramidal neurons in mice. During a threat-inducing tail suspension (TS) paradigm in mice, we find a combined rate and temporal code such that neuronal population activity distinguishes passive and active coping periods and tracks the relative elapsed time during individual coping events. Prefrontal time tracking is independent from rate coding of behavioral state, and is better explained by relative elapsed time than absolute time. Low-dimensional manifold of the population activity shows distinct regions corresponding to struggle and immobility, with specific trajectories corresponding to the temporal evolution of coping sequences. These results suggest that mPFC population activity encodes coping strategies and monitors the progression of time during self-paced action selection.

Real-time whistle pitch-matching in wild nightingales

Giacomo Costalunga¹, Daniela Vallentin¹

¹Max Planck Institute for Biological Intelligence, Neural Circuits for Vocal Communication, Eberhard-Gwinner-Strasse 1, 82319 Seewiesen, Germany

Absolute pitch is the rare human ability to accurately identify the fundamental frequency of a given sound and precisely reproduce it. Pitch perception has been investigated in different animal species, but less is known about the real-time vocal imitation of a sound's pitch. The common nightingale (*Luscinia megarhynchos*) offers an ideal model to investigate auditory-vocal integration, as these songbirds naturally engage in song-matching duels against conspecifics, listening to and repeating the songs sung by their rivals. Additionally, these birds sing whistle songs consisting of frequency-unmodulated sounds that span across a broad distribution of fundamental frequencies (1000 – 9000 Hz) in distinct clusters following lognormal periodicity. To investigate whether nightingales are naturally matching the pitch of whistle songs of conspecifics, we recorded interacting pairs of wild birds. We found that nightingales used these songs to match each other and that they targeted the fundamental frequency of their whistles to match the pitch of their rivals. To investigate to what extent wild nightingales are able to adjust pitch of whistle matches, we performed playback experiments exposing wild birds to synthetic whistle songs of different pitches. We found that nightingales engaged with the stimuli by answering to and flexibly adjusting the pitch of their whistle to match the pitch of the playbacks. These results indicate that wild nightingales can spontaneously perform absolute pitch perception and production, flexibly controlling their vocal responses in real-time to precisely target auditory stimuli.

Selective attention in the highspeed decisions of hunting archerfish

Sophie Yvonne Schödel¹, Martin Krause¹, Wolfram Schulze¹, Stefan Schuster¹

¹University of Bayreuth, Animal Physiology, Universitätsstrasse 30, 95440 Bayreuth, Germany

In their unique hunting archerfish down aerial prey with powerful shots of water and use their predictive C-starts to secure them against heavy competition. Based on only 40 milliseconds of the prey's initial movement the fish decide on a rapid C-start that turns the fish right toward where prey will later land and lends the speed to arrive simultaneously with it at the point of catch.

Remarkably, when confronted with two objects that simultaneously move in opposing directions, the fish do not average the movement cues but selectively base their start-decision exclusively on the movement of one object, selecting that one whose landing point is closer. This added decision neither affects latency nor accuracy of the predictive C-start.

Here we challenge the fish with up to eight objects that simultaneously emerge from a fixed spot but move in different directions. This approach has just recently become possible by using a virtual reality setup in which archerfish start to virtual landing points of moving objects shown on a screen and demonstrably do so with the same accuracy as with falling real objects.

This technique allowed us to randomly confront archerfish with two, four or eight objects moving simultaneously while we assayed the latency and accuracy of their C-start decisions to any of the virtual landing points. To control whether the angle between trajectories and not the number of objects was critical we included 45°, 90° and 180° between the objects in the two-object presentations.

Surprisingly, we find, that the fish were always able to selectively attend to one of the moving objects: In any given situation the fish decided to start toward one of the possible landing points but did not mix movement cues. While latency increased with an increase in the number of objects, accuracy was approximately stable. Most importantly, even with eight objects the fish still selected non-randomly and preferred the one object whose future landing point was closest. Our findings suggest that the fish's highspeed decision manages to keep track of eight possible movements and potential target points.

Social odour activates the hippocampal formation in zebra finches (*Taeniopygia guttata*)

Uwe Mayer

¹Center of Mind and Brain Sciences - University of Trento, Neurobiology of Comparative Cognition Group, Piazza Manifattura 1, 38068 Rovereto (TN), Italy

Olfaction in birds, which has long been considered unimportant, plays a prominent role as communication channel. For instance, odour cues are used by zebra finch chicks to recognise the mother, by adult birds to distinguish their own eggs, or to recognise kin. Despite that, it is largely unknown which areas, besides the olfactory bulb, process socially relevant odours in the avian brain. We compared brain activation in zebra finch males exposed to their own offspring odour vs. a neutral odour. We found an increase of head-saccades in males exposed to their offsprings' odour and changes in activity of the hippocampus of the two hemispheres. We conclude that the hippocampus is involved in odour based social communication in zebra finches.

Spatial coding by somatostatin and neurotensin neurons in the lateral septum

Robson Scheffer Teixeira¹, Francisco Javier de los Santos Bernal^{1,2}, Letizia Moscato^{1,2},
Tatiana Korotkova^{1,2}

¹Institut for Vegetative Physiology, Faculty of Medicine, University of Cologne, Cologne, North Rhine-Westphalia, Germany

²Max Planck Institute for Metabolism Research, Cologne

The animal's ability to remember the location of rewarding and/or aversive stimuli is crucial for survival. The lateral septum (LS) integrates information about environmental stimuli and internal states signals to weigh the expression of different behavioral outcomes, like food-seeking, social recognition, locomotion, and anxiety-like behaviors.

Here we used single cell, deep-brain calcium imaging in freely moving mice to investigate two GABAergic neuronal populations identified in the LS, neurotensin (Nts) and somatostatin (Sst) neurons. Mice explored an enclosure containing rewarding stimuli, or a non-rewarded enclosure. We found that a subset of Sst and Nts cells shows spatial, location-restricted activity. Sst neurons exhibited a higher percentage of place cells, a higher mutual information and a higher place field stability than Nts neurons. Further, Sst neurons showed a higher percentage of reward-associated cells and a higher reward-type selectivity.

Our results suggest the involvement of a subset of LS neurons in the spatial and reward-related coding.

We gratefully acknowledge support by the ERC Consolidator Grant (772994, FeedHypNet, to T.K.) and DFG (SFB1089 and EXC2030-CECAD, to T.K., 233886668-GRK1960, to F.S.).

The reverse cocktail party problem: Dynamic time-domain jamming avoidance in freely socializing bats

Ava Kiai¹, Manfred Koessl¹, David Poeppel², Julio Hechavarria¹

¹Goethe University Frankfurt, Auditory Computations Lab, Frankfurt am Main, Germany

²Ernst Strüngmann Institut, Poeppel Lab, Frankfurt am Main, Germany

Bats live and navigate in noisy environments, where acoustic signals are commonly masked or degraded by ambient noise. While acoustic jamming avoidance in the spectral domain has been documented in several bat species, less attention has been paid to how bats may exploit the temporal domain to avoid acoustic interference with vocalizations. In this study, we presented groups of freely socializing *Carollia perspicillata* bats with amplitude modulated white noise that masked significant portions of the frequency band used for both echolocation and social communication. We found that adult bats spontaneously adjusted the timing of their vocalizations to fall predominantly within the quieter portions of the amplitude modulation cycle, clustering call onsets within the amplitude trough. In addition, the number of emitted vocalizations decreased in proportion to the degree of spectral masking incurred by the noise. Our findings suggest that bats can dynamically adapt their calling behavior to maintain signal quality in the presence of rhythmic, predictable ambient noise. Our findings highlight the impressive vocal plasticity of Phyllostomids and pose new questions regarding active sensing mechanisms in the vocal-auditory system of bats.

Poster Topic

T25: Learning and Memory

- [T25-1A](#) “*What a pleasure when the pain subsides*” Towards a molecular architecture of learning from pain relief
Christian König, Thomas Niewalda, Melissa Comstock, Svea Königsmann, Juliane Thoener, Bertram Gerber
- [T25-2A](#) A dedicated, non-olfactory mushroom body sub-circuit mediates the interaction between goal-directed actions and habit formation in *Drosophila*
Radostina Lyutova, Silvia Marcato, Björn Brembs
- [T25-3A](#) A persistent prefrontal reference frame across time and task rules
Hannah Muysers, Hung-Ling Chen, Jonas-Frederic Sauer, Marlene Bartos
- [T25-4A](#) A selectable eye marker affects memory formation in *Drosophila melanogaster* larvae.
Hanna Rebekka Franz
- [T25-5A](#) A Spectral Chronometer for Interval Timing in *Drosophila*
Jan Kropf, Clifford B. Talbot, Gero Miesenböck
- [T25-7A](#) Analysis of burst sequences in mouse prefrontal cortex during learning
Hamed Shabani, Hannah Muysers, Jonas-Frederic Sauer, Marlene Bartos, Christian Leibold
- [T25-8A](#) The antler brain region of *Drosophila* – Morphological classification of innervating neurons and connectome analysis
Jens Goldammer, Kei Ito
- [T25-9A](#) Attack based identification of most informative patterns in fMRI visual stimuli classification
Markos Athanasiadis, Svenja Brodt, Svenja Klinkowski, Steffen Gais, Christian Leibold
- [T25-10A](#) Automated, unsupervised training and testing for non-human primates on visuo-acoustic tasks
Jorge Cabrera-Moreno, Lena Jeanson, Jonas Grunenberg, Antonino Calapai, Marcus Jeschke
- [T25-11A](#) Can short-term plasticity form anisotropic connectivity?
Arash Golmohammadi, Christian Tetzlaff
- [T25-12A](#) Capturing dynamics of inhibitory synaptic connectivity underlying learning using in vivo two-photon optical imaging of hippocampal CA1

Hannah Klimmt, Alessandro Ulivi, Rosa Huettl, Stefanos Somatakis, Alessio Attardo

- [T25-13A](#) Central modulation in reward processing
Ulrike Sophie Franke, Samantha Aurich, Andreas Stephan Thum, Robert Johannes Kittel, Dennis Pauls
- [T25-14A](#) Choosing memory retrieval strategies: a critical role for inhibition in the dentate gyrus
Alice Weiglein, Iris Müller, Gürsel Caliskan, Oliver Stork, Anne Albrecht
- [T25-15A](#) Coding differences for small and large numerosities in human single neurons
Esther Friederice Kurz, Gert Dehnen, Valeri Borger, Rainer Surges, Florian Mormann, Andreas Nieder
- [T25-16A](#) Constructing auditory space: modulation of the spatial map by auditory cues and landmarks
Andrey Sobolev, Anton Sirota, Michael Pecka
- [T25-17A](#) Dissecting the function of different Duncce isoforms in *Drosophila melanogaster*
Timo Hasselmann, Marie Müller, Marcel Verbrüggen, Magdalena Gompert, Victoria Brüning, Henrike Scholz
- [T25-18A](#) Dissecting the function of the PDE4D orthologue Duncce in olfactory learning and memory in the adult *Drosophila melanogaster*
Duran Emre Kanaci, Henrike Scholz
- [T25-19A](#) Projection-specific conjunctive coding of space, velocity, and appetitive behaviours by dorsal hippocampus
Oliver Barnstedt, Petra Mocellin, Stefan Remy
- [T25-1B](#) Dissection of neuronal circuits underlying aversive olfactory second-order conditioning
El Yazid Rachad, André Fiala
- [T25-2B](#) Dopamine's role as an inhibitor of dopaminergic neurons of the *Drosophila* mushroom bodies.
Michael-Marcel Heim, David Oswald
- [T25-3B](#) Drift and stabilization of hippocampal response selectivity
Alexander Schmidt, Fred Wolf, Yasunori Hayashi, Kotaro Mizuta, Masaaki Sato, Julian Vogel, Bernhard Badow
- [T25-4B](#) Effect of internal states on memory consolidation in *Drosophila*
Sridhar rajan Jagannathan, Davide Raccuglia, David Oswald
- [T25-5B](#) Effect of NPSR1 deficiency on T-maze and Barnes maze learning
Ahmet Oguzhan Bicakci, Evelyn Kahl, Malgorzata Kolodziejczyk, Luibov Kalinicheno, Markus Fendt
- [T25-6B](#) Effects of pyrethroids on honey bee olfactory perception, learning and processing

Loïc Colin-Duchevet, Clémentine Hatton, Antoine Couto, Claude Collet, Pierre Charnet, Jean-Christophe Sandoz

[T25-7B](#) In-vivo imaging of cAMP dynamics: Subcellular compartmentalization underlying learning and memory.
Stephan Hubertus Deimel, André Fiala

[T25-8B](#) Evaluation of six new Octopamine Trojan Exon mutants
Alexandra Großjohann, Ronja Badelt, Dennis Pauls, Andreas Thum

[T25-9B](#) Eye blink is an excellent measure for spatial learning in human
Motoharu Takao

[T25-10B](#) Female vocal feedback improves song learning and alters premotor activity in juvenile zebra finches
Linda Bistere, Daniela Vallentin

[T25-11B](#) fMRI reveals learning induced changes in auditory-evoked brain activation patterns in the Mongolian gerbil
Annika Michalek, Patricia Wenk, Nicole Angenstein, Eike Budinger

[T25-12B](#) From connectomic to behavioural complexity in larval *Drosophila*?

Edanur Sen, Juliane Thöner, Arman Behrad, Melissa Comstock, Nina Jacob, Amira El-Keredy, Nino Mancini, Bertram Gerber

[T25-13B](#) Holistic Bursting Cells as an Auditory Engram
Hongbo Jia

[T25-14B](#) How interneurons shape behavior: The impact of DNA methyltransferase 1 (DNMT1) on inhibitory cortical interneurons of behaving mice
Jenice Reimara Nicola Linde, Can Bora Yildiz, Julia Reichard, Georg Pitschelatow, Geraldine Zimmer-Bensch

[T25-15B](#) Impaired pattern completion during memory recall in an adult mouse model of fragile X Syndrome

Caroline Zeitouny, Martin Korte, Kristin Michaelsen-Preusse

[T25-16B](#) Mechanisms of memory consolidation in *Drosophila melanogaster*
Tania Fernandez d.V. Alquicira, Lisa Scheunemann, Desiree Laber, David Oswald

[T25-17B](#) Mitochondrial function in dopaminergic neurons influence olfactory learning and memory in *Drosophila melanogaster*
Michèle Tegtmeyer, Justin Böcker, Anica Biermann, Sabrina Peter, Melissa Beste, Henrike Scholz

- [T25-18B](#) Neonatal olfactory processing is necessary for the maturation of limbic-hippocampal network and cognitive development
Yu-Nan Chen, Johanna K. Kostka, Sebastian H. Bitzenhofer, Ileana L. Hanganu-Opatz
- [T25-19B](#) Neural circuits that regulate exploratory odor-driven behavior
Giovanni D`Uva, Christian Daniel, Maria Loannidou, Leticia Batista , Carlotta Martelli
- [T25-1C](#) Neural correlates of cooperation in freely moving rhesus macaques
Melissa Franch, Sudha Yellapantula, Anthony Wright, Valentin Dragoi
- [T25-2C](#) Neuromodulator-dependent two-phase synaptic plasticity retroactively controls neural coding in spiking neural networks
Jannik Luboeinski, Andrew B. Lehr, Christian Tetzlaff
- [T25-3C](#) Perception of optogenetic cortex stimulation is modality-specific
Alisa Vlasenko, Marcel Brosch, Frank W. Ohl, Michael T. Lippert
- [T25-4C](#) Prediction error drives olfactory learning and conditioned behavior in a spiking model of *Drosophila* larva
Anna-Maria Jürgensen, Panagiotis Sakagiannis, Michael Schleyer, Bertram Gerber , Martin Paul Nawrot
- [T25-5C](#) ProBDNF Dependence of LTD in the Amygdala of Adult Mice
Susanne Meis, Xiaoyun Ma, Thomas Endres, Thomas Munsch, Volkmar Lessmann
- [T25-6C](#) Pro-BDNF signaling in the amygdala mediates fear extinction learning
Thomas Endres, Harish Vuyyuru, Susanne Meis, Volkmar Lessmann
- [T25-8C](#) Rab3 is required for olfactory learning
Aishwarya Aravamudhan, Divya Sachidanandan, Dennis Pauls, Stefan Hallermann, Robert J. Kittel
- [T25-9C](#) Role of Nogo-A in regulating memory processes and memory engram formation by modulating neuronal excitability
Sebastian Stork, Jan Flechtner, Jennifer Just, Kristin Metzdorf, Steffen Fricke, Martin Korte, Marta Zagrebelsky
- [T25-10C](#) Serotonin antagonistically controls aversive and appetitive memory consolidation in flies
Lisa Scheunemann, Clément Hua, Beatrice Kaiser, Anne Hoffmann, Olliver John, Thomas Preat
- [T25-11C](#) Silencing of HVC interneurons during playbacks alters adult zebra finch song
Fabian Heim, Ezequiel Mendoza, Avani Koparkar, Constance Scharff, Daniela Vallentin
- [T25-12C](#) Social feedback shapes behavioral strategies for courtship in *Drosophila*
Frederic Alexander Römschied, Elise C Ireland, Adam J Calhoun, Minseung S Choi, Osama

Ahmed, Mala Murthy

[T25-13C](#) Synaptic structural homeostatic mechanisms in the hippocampal CA1 region of live mice
Bhargavi Murthy, Hannah Klimmt, Inna Slutsky, Alessio Attardo

[T25-14C](#) *Ida&å*

[T25-15C](#) The cellular architecture of memory modules in *Drosophila* supports stochastic input integration
Rouven Ziegler, Omar A. Hafez, Benjamin Escribano, Jan J. Hirtz, Ernst Niebur, Jan Pielage

[T25-16C](#) The virtual magnetic environment: Towards a fast and robust behavioural assay to study magnetoreception in subterranean mole-rats
Georgina Fenton, Brittany Hamauei, Pascal Malkemper

[T25-17C](#) Toxic effects of neonicotinoids on memory and brain morphology: the fruit fly *Drosophila melanogaster* as a study case.
Annekathrin Widmann, Julia Schulz

[T25-18C](#) Understanding rat behavior in a complex task via non-deterministic policies

Johannes Niediek, Maciej M. Jankowski, Ana Polterovich, Alexander Kazakov, Israel Nelken

“*What a pleasure when the pain subsides*” Towards a molecular architecture of learning from pain relief

Christian König¹, Thomas Niewalda¹, Melissa Comstock¹, Svea Königsmann¹, Juliane Thoener¹, Bertram Gerber¹

¹Leibniz Institute for Neurobiology, Department Genetics of Learning and Memory, Magdeburg, Germany

Receiving punishment feels bad, but relief upon its termination feels good. These experiences result in aversive and appetitive learning of associated cues, respectively. In turn, receiving reward vs. the frustration when it is terminated support appetitive and aversive learning (Figure 1). Our work has established such timing-dependent valence-reversal as an across-species principle (Gerber et al. 2019). From a clinical perspective, considering distortions of timing-dependent valence reversal may offer new views of pathological behaviors. For example, distortions in favor of relief processing may promote self-cutting to bring about relief, or may establish maladaptively strong ties to places where fear or panic subside.

We report on our ongoing experiments, in *Drosophila melanogaster* as a study case, to uncover the molecular architecture of learning through pain relief. Our focus is on the contribution of the dopamine and serotonin systems, and on the role of the cAMP cascade in this respect.

References:

- Gerber et al. Timing-dependent valence reversal: a principle of reinforcement processing and its possible implications. *Curr Opin Behav Sci.* (2019).
- König et al. Reinforcement signalling of punishment vs. relief in fruit flies. *Learn Mem.* (2018).
- Saumweber et al. Functional architecture of reward learning in mushroom body extrinsic neurons of larval *Drosophila*. *Nature Commun.* (2018).
- Thoener et al. Optogenetically induced reward and ‘frustration’ memory in larval *Drosophila*. *J Exp Biol.* (2022).
- Weiglein et al. Aversive teaching signals from individual dopamine neurons in larval *Drosophila* show qualitative differences in their temporal ‘fingerprint’. *J Com. Neurol.* (2021).

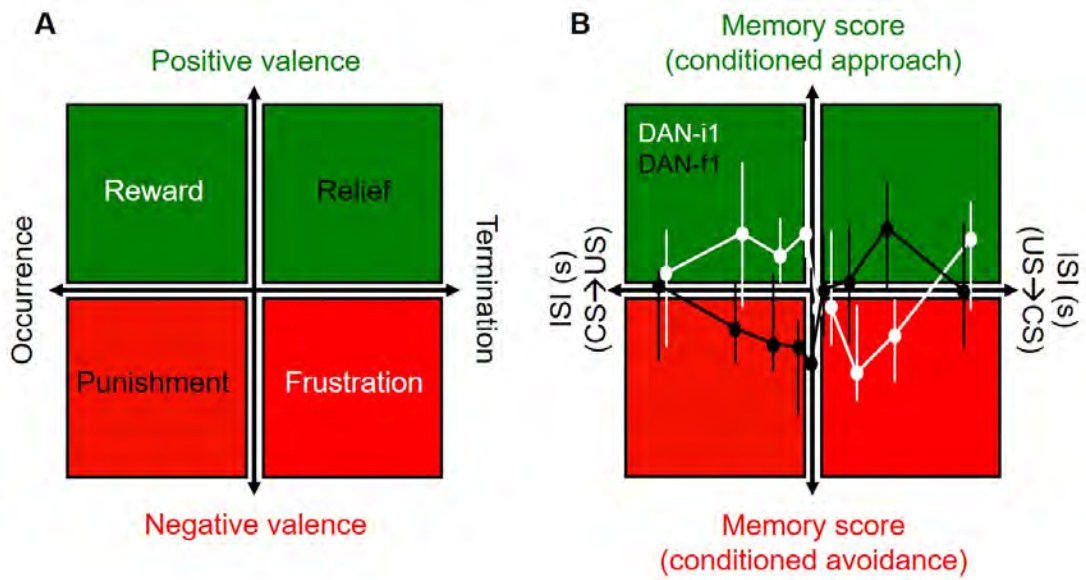

Figure 1. Timing-dependent valence reversal A) 2x2 valence matrix of valence related to the occurrence / termination of punishment (black) and reward (white). B) Memories established by presenting odour with the onset/ offset of optogenetically activating the indicated individual DANs (Saumweber et al 2018, Weiglein et al 2021, Thoener et al 2022; also see König et al. 2018).

A dedicated, non-olfactory mushroom body sub-circuit mediates the interaction between goal-directed actions and habit formation in *Drosophila*

Radostina Lyutova¹, Silvia Marcato¹, Björn Brembs¹

¹University of Regensburg, Neurogenetics, Universitaetsstr. 31, 93053 Regensburg, Germany

Goal-directed exploration of the environment allows an animal to learn about the relationships between stimuli and how the environment responds to its actions. In this goal-directed phase, animals can flexibly apply learned relationships to other contexts. However, flexibility usually implies a cost in time, together with higher cognitive and energetic costs. In contrast, the formation of habits ensures fast and efficient behaviors. The learning mechanisms that lead to flexible and efficient behaviors, respectively, interact with each other. During the early, goal-directed phase of such composite operant learning situations, the process that mediates learning about relations in the environment (world-learning) is known to inhibit the process that renders behaviors stereotypic and efficient (self-learning), presumably in order to prevent premature habit formation. In humans, imbalance between flexible actions and habitual responses can be linked to neuropsychiatric disorders such as obsessive-compulsive disorder or addiction. We use the fruit fly *Drosophila* to study the interactions between world- and self-learning which mediate the transition mechanisms from goal-directed actions to habitual responses. In *Drosophila* goal-directed behavior inhibits habit formation at the level of the mushroom bodies (MB), such that inhibition of the MBs results in premature habit formation. We identified a single MB output neuron (MBON- $\beta 2\beta'2a$) controlling the transition from goal-directed actions to habits. Together with the behavioral results, the anatomy of this neuron indicates that non-olfactory MB Kenyon cells of the $\beta 2$ and $\beta'2$ -lobes are involved in this transition. These neurons receive input via their dendrites in the little-studied lateral and dorsal accessory calyx regions of the MB.

A persistent prefrontal reference frame across time and task rules

Hannah Muysers^{1,2}, Hung-Ling Chen¹, Jonas-Frederic Sauer^{1,3}, Marlene Bartos^{1,3}

¹University of Freiburg, Faculty of Medicine, Physiology I, Hermann-Herder-Str. 7, 79104 Freiburg, Germany

²University of Freiburg, Faculty of Biology, Schaenzlestrasse 1, 79104 Freiburg, Germany

³Corresponding authors

The medial prefrontal cortex (mPFC) is activated during the recall of long-term contextual memories. However, how these memories are maintained over a long period of time is still unknown. To shed light on this, we asked three main questions: (1) how is long-term contextual memory encoded in the mPFC? (2) what kind of stimuli influences the representation? And (3) how is the representation shaped during learning? To address these questions, we used 1-photon calcium imaging in Thy1-GCaMP6f mice during an olfaction guided spatial memory task. In this task mice needed to associate an odour (presented in the centre-arm of an M-maze), with a specific reward location (left or right side-arm). For question 1) our results show that a majority of active cells are spatially tuned and stably and reliably keep their spatial tuning across several weeks with only a mild drift. Moreover, when we trained a decoder on neuronal data from the first day, we were able to predict trial identity and the animal's location in the maze over the full experimental period of 24 days. This reveals a stable, long-term encoding of contextual memories in the mPFC. With regard to question 2) the stability of the spatial representation was unperturbed during introduction of breaks in task-exposure, during visual modification of the arena or switching of the cue-location pairing. This suggests a rather abstract and robust representation of the task structure. Question 3) showed that spatial tuning stability was lower in the initial phase of task exposure, indicating that the stability of the representation emerges during learning. Taken together, such a coding may provide a stable reference frame, which might support the animal's navigation in the task-context and allows for quick task-related decisions.

A selectable eye marker affects memory formation in *Drosophila melanogaster* larvae.

Hanna Rebekka Franz¹

¹Schwann-Schleiden Research Center Göttingen, Molecular Neurobiology of Behavior, Julia-Lermontowa-Weg 3, 37077 Göttingen, Germany

Since its description in the first half of the last century the *w1118* null allele of the *white* gene has become a popular genetic marker due to its easy-to-score white eye phenotype. One wide-spread application of the *w1118* allele as selectable marker can be found in the process of generating new transgenic fly lines. Here, a transfection construct consisting of the transgene of interest complemented by a short version of the *white* gene ('*mini-white*') is inserted into the genome of *w1118* flies. Thus, a successful insertion of the transgene is marked by a rescue of the red wild-type eye colour. As fly lines created using this technique do not express a wild-type *white* but the truncated mini version, it is common to use the heterozygous offspring of a cross between the experimental transgenic line (Gal4-driver/UAS-effector) and the *w1118* line as genetic controls.

However, over the past years increasing evidence emerged that a loss-of-function mutation of the *white* gene does not only affect the eye colour but causes behavioral phenotypes unrelated to vision [1-4] which cannot be reliably rescued by the presence of only one *mini-white* copy [2,3].

Here, we describe a new behavioral phenotype of *white* mutants in the larval stage of *Drosophila melanogaster* by using aversive olfactory conditioning to evaluate the memory formation ability in a quantitative and qualitative manner. While *w1118* larvae were able to form aversive memory, gating between a less durable anesthesia-resistant memory (ARM) and a stable long-term memory (LTM) differed from the wild-type.

Together with previously described behavioral impairments [1-4], this finding suggests an implication of *white* in diverse processes outside of the eye including learning and memory. Thus, it would be reasonable to review the usage of *white* mutants as controls in behavioral assays and enlightening to reveal the molecular involvement of *white* in learning and memory formation.

[1] Campbell JL, Nash HA. Volatile general anesthetics reveal a neurobiological role for the white and brown genes of *Drosophila melanogaster*. *J Neurobiol.* 2001 Dec;49(4):339-49. doi: 10.1002/neu.10009. PMID: 11745669.

[2] Myers JL, Porter M, Narwold N, Bhat K, Dauwalder B, Roman G. Mutants of the white ABCG Transporter in *Drosophila melanogaster* Have Deficient Olfactory Learning and Cholesterol Homeostasis. *Int J Mol Sci.* 2021 Nov 30;22(23):12967. doi: 10.3390/ijms222312967. PMID: 34884779; PMCID: PMC8657504.

[3] Diegelmann S, Zars M, Zars T. Genetic dissociation of acquisition and memory strength in the heat-box spatial learning paradigm in *Drosophila*. *Learn Mem.* 2006 Jan-Feb;13(1):72-83. doi: 10.1101/lm.45506. Epub 2006 Jan 17. PMID: 16418434; PMCID: PMC1360135.

[4] Chan RF, Lewellyn L, DeLoyht JM, Sennett K, Coffman S, Hewitt M, Bettinger JC, Warrick JM, Grotewiel M. Contrasting influences of *Drosophila white/mini-white* on ethanol sensitivity in two different behavioral assays. *Alcohol Clin Exp Res.* 2014 Jun;38(6):1582-93. doi: 10.1111/acer.12421. Epub 2014 May 30. PMID: 24890118; PMCID: PMC4049357.

A Spectral Chronometer for Interval Timing in *Drosophila*

Jan Kropf¹, Clifford B. Talbot¹, Gero Miesenböck¹

¹University of Oxford, Centre for Neural Circuits and Behaviour, Mansfield Road, OX1 3SR Oxford, United Kingdom

Behavior is temporally structured at multiple scales. We show that *Drosophila*, a classic model for understanding circadian timing, can estimate, remember, and reproduce durations in the range of seconds. This inner sense of time relies on a spectral chronometer in the mushroom bodies. Following an olfactory cue, the Kenyon cell (KC) ensemble generates a continuous representation of time from odor onset to odor offset and beyond, with different neurons responding maximally at characteristic latencies. Genetically distinct KC divisions carry parallel odor representations that differ subtly in the temporal transformations they apply to olfactory input. In combination with KC output synapses exhibiting bidirectional anti-Hebbian plasticity, the temporally dispersed KC responses allow the mushroom body to function as an adaptive filter for predicting temporal relationships between events.

Analysis of burst sequences in mouse prefrontal cortex during learning

Hamed Shabani², Hannah Muysers^{1,3}, Jonas-Frederic Sauer³, Marlene Bartos^{2,3},
Christian Leibold^{1,2}

¹University of Freiburg, Faculty of Biology, Freiburg, Germany

²University of Freiburg, Bernstein Center, 79104 Freiburg, Germany

³University of Freiburg, Institute of Physiology I, Freiburg, Germany

The prefrontal cortex (PFC) plays an important role in working memory [1], however, the underlying neural processes remains elusive. Studies on the hippocampus revealed that place cells sequences encode goal-directed behavior in rats [2]. In this study, we report about the existence of similar sequential activation patterns in PFC and their correlation with behavior in a working memory task.

Experiments are conducted with one-photon calcium imaging in Thy1-GCaMP6f mice during an olfaction-guided spatial memory task in a three-arm arena consisting of sampling, choice, and reward conditions. In order to get the reward, animals had to learn to associate odorants presented in the middle arm to the reward location in the left or right arm. Calcium traces of PFC neurons were used for sequence analysis (Fig 1.A). Sequences were searched in activity bursts within 200 ms time windows and analyzed under four task conditions; habituation, learning, recall, and sleep. Sequences were least prominent in sleep data and rates were significantly lower during learning than in the recall phase. (Fig 1.B). Next, all sequences were grouped into different clusters using a hierarchical clustering algorithm based on their pair-wise order similarity matrix. We then assessed the extent to which the firing order of individual sequences during learning and recall matched the mean template representing the dominant cluster from a task condition. We observed that sequences recorded during the recall phase are more aligned with templates derived from recall than sequences from the learning phase. Such a difference, however, was not observed for templates derived from the learning phase (Fig 1.C), indicating that the expression of PFC sequences change as the animal learns. Results were consistent across data of individual animals and the pooled data of four animals.

Our results show that 1-P recordings allow for the analysis of fast sequences in the PFC and that fast PFC sequences exhibit task phase-dependent differences in rate and content. These findings suggest a potential role of PFC sequential activation in working memory tasks.

This work was funded by the DFG RU 5159 Prefrontal flexibility.

References:

[1]: Miller EK, Lundqvist M, Bastos AM (2018) Working Memory 2.0. *Neuron* 100:463-475.

[2]: Pfeiffer BE, Foster DJ. Hippocampal place-cell sequences depict future paths to remembered goals. *Nature*. 2013 May;497(7447):74-9.

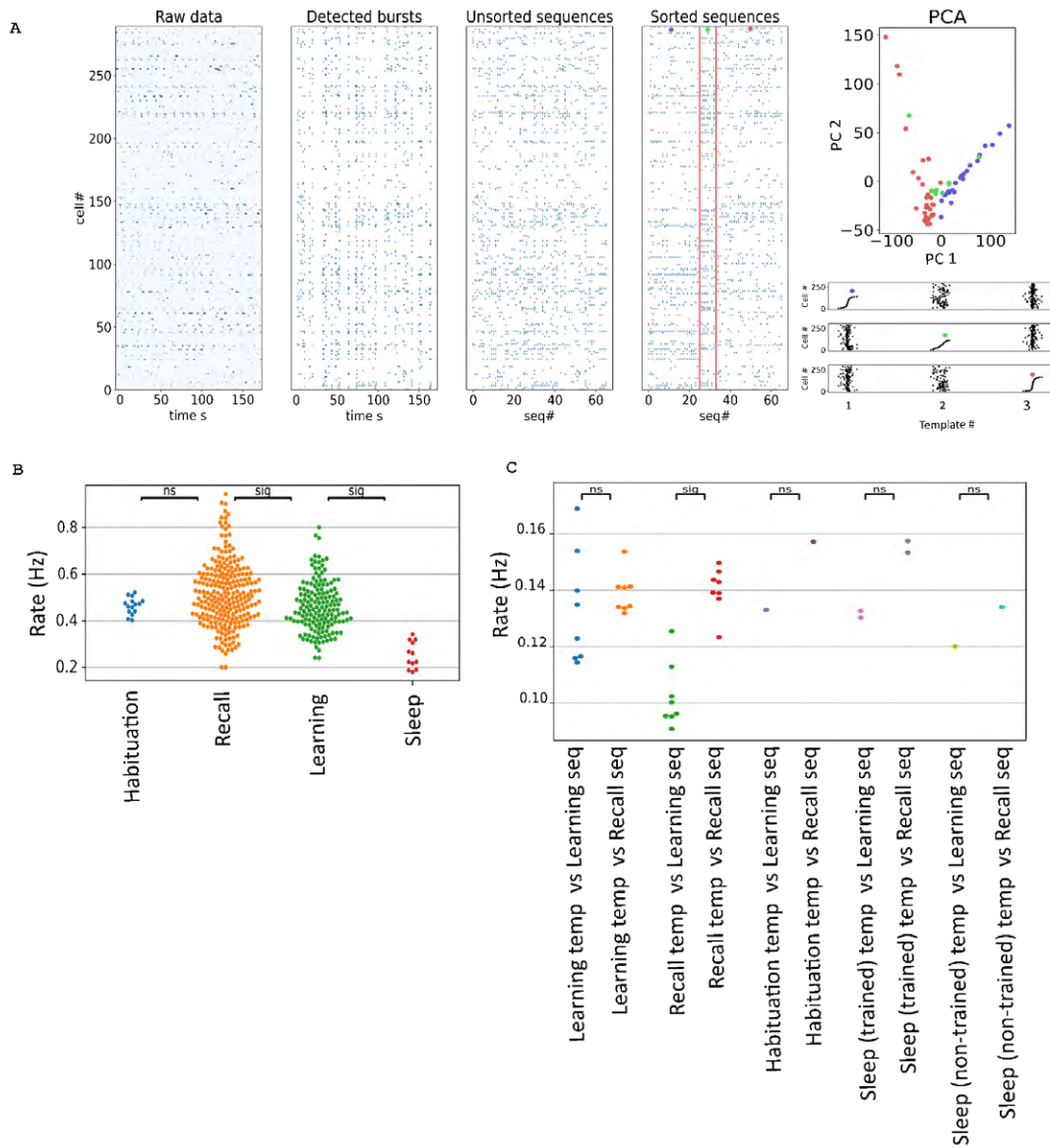

Figure 1: A) Sequences of a sample recording session during reward consumption. From left: raw normalized calcium traces, detected bursts in time, detected sequences in order of occurrence, detected sequences sorted according to cluster membership (red lines separate each cluster, color dots represent cluster membership), Top right: presentation of first two principal components of clustered bursts (each color refers to one cluster), (bottom) cluster representatives, sorted according to each one of the 3 clusters. B) Sequence rate of pooled neurons from 4 animals for different conditions. C) Average rates of sequences matching a cluster template.

The antler brain region of *Drosophila* – Morphological classification of innervating neurons and connectome analysis

Jens Goldammer^{1,2}, Kei Ito^{1,2}

¹University of Cologne, Biocenter, Institute of Zoology, Zùlpicher Str. 47b, 50674 Köln, Germany

²HHMI Janelia Research Campus, Ashburn, VA, USA

Only few brain regions in the adult *Drosophila* brain have been extensively studied, such as the central complex or the mushroom body (MB). One of the relatively unknown regions in the fly brain is antler (ATL). ATL is a small and thin neuropil located in the posterior part of the brain, connecting the superior lateral protocerebrum with the inferior bridge in an arch-like fashion (Ito et al. 2014). As yet, we do not have detailed information about the neuronal circuit architecture and potential function of ATL.

To facilitate a better understanding of ATL, we screened several thousand GAL4 expression driver lines of *Drosophila* to identify and describe the morphology of neurons that innervate ATL. We also used the multi-color flip-out (MCFO) technique to provide detailed information about single cell morphology. By using the split-GAL4 intersectional strategy (e.g. Luan et al. 2006), we were able to generate stable fly lines whose expression patterns are specific to neurons innervating ATL. We also classify ATL neurons and analyze their connections in the electron microscope (EM) hemibrain connectome dataset (Scheffer et al. 2020).

Here, we show identified ATL neurons in split GAL4 lines and MCFO samples in comparison with their EM hemibrain counterparts to analyze their completeness. We then clustered the ATL neurons according to morphological features like common projection targets and identified multiple clusters, each of which forming different pathways. Neurons of one cluster have dendrites anterior to the MB medial lobes and send information posteriorly to the ATL and neighboring neuropils. Another cluster sends information in the opposite direction for potential signal feedback. Other clusters receive signals from olfactory-associated neurons or from the wedge, a neuropil for antennal mechanosensation. Our analysis suggests that ATL converges olfactory and mechanosensory information and potentially modulates the learning and memory system via feedback loops.

Attack based identification of most informative patterns in fMRI visual stimuli classification

Markos Athanasiadis¹, Svenja Brodt², Svenja Klinkowski², Steffen Gais², Christian Leibold^{1,3}

¹Albert-Ludwigs-University, Fakultät für Biologie & Bernstein Center Freiburg, 79104 Freiburg, Germany

²University of Tübingen, Institute of Medical Psychology and Behavioral Neurobiology, 72016 Tübingen, Germany

³Albert-Ludwigs-Universität Freiburg, BrainLinks-BrainTools, 79110 Freiburg, Germany

The stabilization of transient memory traces after initial acquisition is called memory consolidation and assumed to partly rely on reorganization of memory engrams during sleep. The neo-cortical mechanisms that support memory consolidation are still not fully resolved, however, recent advances in multivariate analysis methods of functional magnetic resonance imaging (fMRI) have allowed us to access active memory representations during encoding and recall phases before and after sleep. Here, we explore fMRI activity patterns in the brain of human subjects during an object-location memory task. During the task, pairs of visual stimuli, belonging to three distinct classes, were repeatedly presented at distinct screen locations for several runs of encoding and recall. Within an encoding run, subjects had to learn associations between pairs of visual stimuli from distinct classes. During a recall run, the first image of a previously learned pair was presented, and the subjects were asked to identify the distinct screen location of the associated visual stimulus. Data was collected from two recording sessions performed 13 hours apart. During this period, half of the subjects were sleeping and the other half was awake. Overall, participants who slept outperformed the wake group in the final recall phase (Figure 1A). We extracted fMRI activity patterns from the occipital lobe and the visual cortex and examined whether the class identity of the stimulus could be decoded using multivariate pattern analysis methods. To that end, we investigated two sets of patterns, one with a clear category distinction between the presented stimuli (fruits vs animals) and one with stimuli from the same category but for which distinct associations were learned (objects associated with fruits vs objects associated with animals). We performed permutation tests across subjects and compared the null distribution of accuracies to the correct classification rate of the observed labels (Figure 1B). Our classifier was able to significantly predict the stimulus class, for maximally 50% of the participating subjects. In order to test whether the brain activity represents the categories (fruits, fruit objects, animals, animal objects), we further validated results against random subgroup assignment of the stimuli and found significant category representations for fruits vs animals, in both occipital lobe and the visual cortex. However, similar results could not be observed when comparing stimuli of the same category but with different learned associations (fruit objects vs animal objects), indicating that the classifiers learned to identify combinations of subclasses rather than stimulus categories.

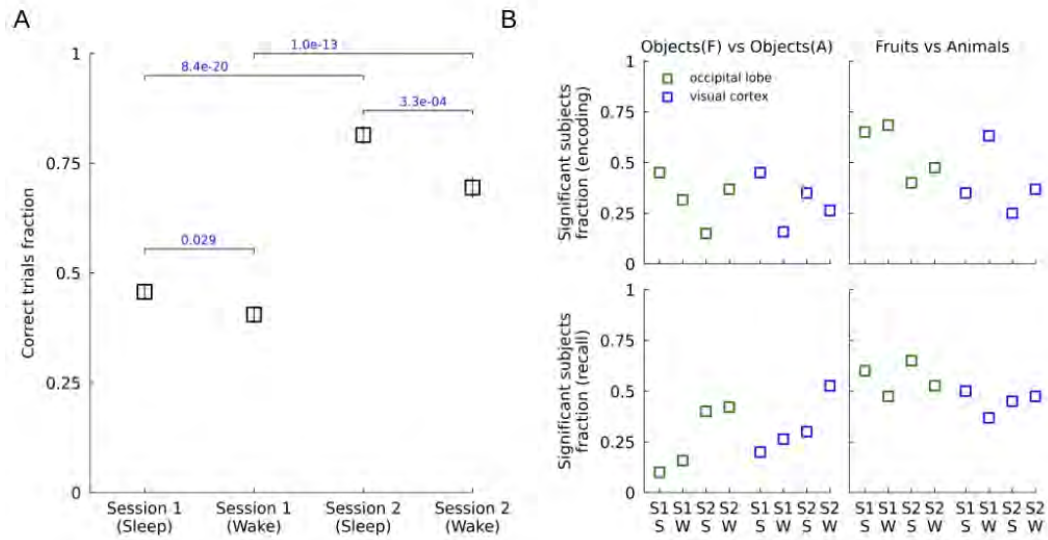

Figure 1. (A) Recall behavioral performance. Significance values reflect Ranksums tests for each of the pairwise group combinations. (B) Fraction of significant subjects identified using permutation tests for the encoding and recall phases. Data is grouped based on the recording session (S1 or S2), the group of subjects that were asleep or awake (S or W) during the period between the two recording sessions, as well as the brain region (green for occipital lobe and blue for visual cortex).

Automated, unsupervised training and testing for non-human primates on visuo-acoustic tasks

Jorge Cabrera-Moreno^{1,2,3,4}, Lena Jeanson^{1,5}, Jonas Grunenberg¹, Antonino Calapai^{1,3,5,6}, Marcus Jeschke^{1,3,4,6}

¹German Primate Center, Cognitive Hearing in Primates, Kellner weg 4, 37077 Goettingen, Germany

²Göttingen Graduate School for Neurosciences, Biophysics and Molecular Biosciences, University of Göttingen, 37075 Göttingen, Germany

³Auditory Neuroscience and Optogenetics Laboratory, German Primate Center - Leibniz-Institute for Primate Research, Göttingen, Germany

⁴Institute for Auditory Neuroscience and InnerEarLab, University Medical Center Göttingen, 37075 Göttingen, Germany

⁵Cognitive Neuroscience Laboratory, German Primate Center - Leibniz-Institute for Primate Research, Göttingen, Germany

⁶Leibniz-ScienceCampus Primate Cognition, 37077, Goettingen, Germany

One of the main barriers to research in complex behaviors in non-human primates (NHP) lies in training animals to perform the desired behavior. Through the implementation of stepwise unsupervised procedures, automating training protocols represent a step towards optimizing a labor-intensive and time-consuming process, thus having a potential impact on applications such as phenotyping models of neurodegenerative diseases, cognitive research, and enhancement of animal welfare. In earlier work, we described a novel paradigm that successfully trained and tested common marmosets (*Callithrix jacchus*) in an automated and unsupervised manner to discriminate conspecific vocalizations from artificial stimuli in a 2 or 3 alternative choice task directly in their home cage without the need for food or water control nor social separation.

To further demonstrate the flexibility of the use of our system, we 1) trained 13 common marmosets to perform a pure tone detection task and 2) trained 6 long-tailed macaques (*Macaca fascicularis*) to perform a visuo-acoustic task. First, 13 marmosets were successfully trained to expect the delivery of reward after the presentation of a pure tone train. This allowed us to devise a Go-NoGo task where animals triggered a pure tone by touching a screen once or touching it twice when the initial touch did not result in a sound being played. With this, we were able to collect audiograms similar to data from published, traditional lab-based approaches. Second, using computer-vision-based machine-learning techniques we could provide individualized training of group-housed long-tailed macaques and found that animals 1) consistently engaged with the device across several months; 2) alternated peacefully to interact with the device; and 3) smoothly ascended from step to step in the visually guided section of the procedure, in line with previous results. However, we also found 4) that animals' performance remained at chance level as soon as the acoustically-guided steps were reached; and 5) that the likelihood of starting a new trial after a correct trial decreased significantly with decreasing hit rate. The latter suggests that even though the animals might perform a similar amount of trials per session across sessions overall, a low hit rate during prolonged periods of time leads the animals to ignore the outcome of the trials, being a possible reason to fail in learning the task.

Taken together, we conclude that it is possible to train non-human primate species directly in their social group and without dietary restriction, to solve a visually guided discrimination task but not necessarily an acoustically guided task with autonomous approaches. Our work lays the ground for future studies into cognition in NHPs and might be used in the assessment of cognitive effects in drug discovery research.

Can short-term plasticity form anisotropic connectivity?

Arash Golmohammadi¹, Christian Tetzlaff¹

¹Universitätsmedizin Göttingen, Computational Synaptic Physiology, Von-Siebold-Str. 3a, 37075 Göttingen, Germany

Learning, memorizing, and information processing in the brain require stable adaptation of the synaptic weights. For such non-linear computations, non-trivial spatiotemporal neuronal activity patterns are necessary. One simple network capable of generating such non-trivial spatiotemporal activity is recently introduced in which nearby cells are connected together in an anisotropic fashion. However, the converse is not clear. i.e., whether or not learning produces anisotropic synaptic connectivity.

We investigate this possibility by exposing an initially isotropic locally-connected network to a sustained stimulation protocol while letting the network adapt its synaptic connections according to the canonical short-term plasticity models. We hypothesize that in steady-state, i.e., long enough stimulation, the synapses form strong anisotropic connectivity. Our implementation leverages the flexibility of the Brain simulator and thus can be readily applied to an analogous study concerning long-term plasticity.

Stable synaptic adaptation has several pertinent implications: memory consolidation, simultaneous memory storage, recall, reinforced learning, and relearning, to name a few. Additionally, in highly connected structures such as the basal ganglia-thalamus-cortex network, connectivity modulation can trigger motor or psychological pathogenesis, as well as abnormal cognitive behavior. Therefore, in addition to its theoretical appeal, understanding structural changes in synaptic connections paves the way for further medication and treatment design.

Capturing dynamics of inhibitory synaptic connectivity underlying learning using in vivo two-photon optical imaging of hippocampal CA1

Hannah Klimmt^{1,2}, Alessandro Ulivi¹, Rosa Huettl², Stefanos Somatakis², Alessio Attardo¹

¹LIN Magdeburg, CNEU, Brenneckestraße 6, 39118 Magdeburg, Germany

²Max-Planck-Institute for Translational Psychiatry, Kraepelinstraße 2-10, 80804 Munich, Germany

The formation of new episodic memories requires the hippocampus. The CA1 hippocampal area exhibits high level synaptic structural plasticity, which is thought to support temporary information storage. By tracking excitatory synapses, it has indeed been shown that hippocampal CA1 has more excitatory structural turnover than neocortical areas, and that such turnover negatively correlates with the ability of mice to recall a hippocampal-dependent memory. However, little is known about the dynamics of inhibitory synapses. Inhibitory neurons have a critical role in episodic memory and the position of inhibitory synapses on CA1 pyramidal neurons strongly influences the computations these neurons carry out. Thus, understanding the dynamics of inhibitory synapses is fundamental to decipher the circuit-level mechanisms underlying encoding of new information. Inhibitory synapses, however, lack a morphological feature, which makes it difficult to visualize them in vivo.

To solve this issue, we tested and optimized different labelling methods with the aim to track inhibitory synapses on excitatory CA1 pyramidal neurons using in vivo time-lapse, deep-brain, 2-photon microscopy in mice. The most promising method was a double viral injection in which one virus expressed cytosolic tdTomato in frame with Cre recombinase under the control of an excitatory promoter and thereby driving the expression of a second virus carrying a Cre-dependent GFP, fused to the inhibitory post-synaptic protein: Gephyrin. Utilizing this labelling method, I tracked inhibitory synapses before and after fear conditioning training to investigate the relationship between CA1 inhibitory synaptic dynamics and hippocampal-dependent learning.

Central modulation in reward processing

Ulrike Sophie Franke¹, Samantha Aurich¹, Andreas Stephan Thum², Robert Johannes Kittel¹, Dennis Pauls¹

¹ Leipzig University, Department of Animal Physiology, Institute of Biology, Talstraße 33, 04103 Leipzig, Germany

² Leipzig University, Department of Genetics, Institute of Biology, Talstraße 33, 04103 Leipzig, Germany

The octopaminergic/tyraminerpic system is known to be the functional homolog of the adrenalin/noradrenalin system of vertebrates. It is involved in learning and memory, fight-or-flight responses, locomotion and various other aspects. Initial work in *Drosophila* suggested that dopaminergic neurons (DANs) signal punishment and octopaminergic neurons (OANs) signal reward during conditioning. More recent work shows that distinct sets of DANs mediate signals for both punishment and reward to mushroom body Kenyon cells, where association with odour information takes place. This seems to somehow overturn the previous functionally separated model (dopamine: bad, octopamine: good) and limits the function of OANs in reward processing. Moreover, it was shown that octopamine (OA) and its precursor tyramine (TA) influence larval locomotion antagonistically, which indicates that a balance between both biogenic amines is necessary. We show, in line with other studies, that OANs are indeed involved in larval learning and memory. However, this occurs through the modulation of individual DANs by OA and TA. To untangle the signalling pathway, we used an optogenetic approach combined with Ca²⁺ imaging. Our results lead us to the hypothesis, that OANs orchestrate memory formation context-dependently by modulating the actual teaching neurons during memory formation and/or recall.

Choosing memory retrieval strategies: a critical role for inhibition in the dentate gyrus

Alice Weiglein¹, Iris Müller^{2,3,4}, Gürsel Caliskan^{2,3}, Oliver Stork^{2,3}, Anne Albrecht^{1,3}

¹Institut für Anatomie, Otto-von-Guericke-University, Neuroanatomie, Leipzigerstr.44, 39120 Magdeburg, Germany

²Institute of Biology, Otto-von-Guericke-University, Leipziger Str. 44, 39120 Magdeburg, Germany

³Center for Behavioral Brain Sciences (CBBS), Universitätsplatz 2, 39106 Magdeburg, Germany

⁴Institute of Pharmacology and Toxicology, Otto-von-Guericke-University, Leipziger Str. 44, 39120 Magdeburg, Germany

Remembering the location of a worthwhile food source is not only crucial for survival but also a major faculty of neural networks. Humans and rodents alike exert two distinct strategies to learn and retrieve reward-featuring locations. The cue response strategy is based on striatal stimulus-response, while the spatial strategy depends on the hippocampus. Especially rodents appear to prefer a spatial strategy. When being stressed, however, a shift to the stimulus-response strategy is observed.

Using transgenic mice susceptible to stress due to a lack of the GABA-synthesizing enzyme GAD65, we investigated whether a reduction of spatial learning preference could be validated. The respective mice were assessed for their memory performance in a dual solution task for which they could learn the location of a food reward in an open field setup utilizing either one of the above-described strategies via proximal or distal cues, respectively.

Interestingly, GAD65 knock out mice lacked a spatial preference during retrieval, but showed undisrupted spatial retrieval when no proximal cue was provided. Regarding the neural activation marker cFos, a shift in the co-activation of the hippocampal dentate gyrus (DG) with frontal cortical brain areas was demonstrated. Further, a shRNA-mediated local knock down of GAD65 within the DG replicated the behavioral effect, thus pinpointing a central role of the dorsal DG for retrieval strategies, particularly modulating strategy choices.

Coding differences for small and large numerosities in human single neurons

Esther Friederice Kurz^{1,2}, Gert Dehnen¹, Valeri Borger³, Rainer Surges¹, Florian Mormann¹, Andreas Nieder²

¹Department of Epileptology, University of Bonn Medical Center, Venusberg-Campus 1, 53127 Bonn, Germany

²Animal Physiology, Institute of Neurobiology, University of Tübingen, 72076 Tübingen, Germany

³Department of Neurosurgery, University of Bonn Medical Center, Venusberg-Campus 1, 53127 Bonn, Germany

Our uniquely human understanding of symbolic number is the foundation of a full-blown number theory that determines our scientifically and technologically advanced culture. How number representations are encoded in the human brain is still not fully understood. Behavioral data suggest two separate systems for the representation of numerical quantity: an implicit, relatively precise object tracking system (OTS, or 'subitizing') that is limited to sets of up to four, and an approximate number system (ANS) used to estimate also larger numerosities but exhibiting increasing errors for increasing set sizes. To explore the putative neuronal correlates of such distinct systems, we recorded single-neuron activity in the medial temporal lobe (MTL) of neurosurgical patients who judged the parity of numerical values 0 to 9 in dot patterns. We observed clear coding differences in the tuning curves of single units responsive to small and large numerosities. These differences between the representation of small and large numerosities were also reflected in population-decoding differences and distinctive population dynamics. This suggests that OTS and ANS are complementary but distinct systems closely collaborating in the processing of numerical information.

Constructing auditory space: modulation of the spatial map by auditory cues and landmarks

Andrey Sobolev¹, Anton Sirota¹, Michael Pecka¹

¹Ludwig-Maximilians University, Neurobiology, Grosshaderner str. 2, 82152 Planegg, Germany

Pathfinding and navigation through one's environment are crucial for survival. Extensive research over the last 50 years identified that in order to build and update the location of self in the world, both external (allocentric) and internal (idiothetic) information streams are used by the brain (reviewed in Moser, Rowland, 2015). As a consequence, a central goal of sensory and navigational neuroscience is to understand how different sensory modalities build a coherent internal spatial representation (Nyberg, Spiers, 2022). So far, researchers have mainly manipulated visual, tactile (walls, borders) and/or olfactory sensory information in pursuit of this goal (Chen, 2013; Aronov, Tank, 2014; Plitt, Giocomo, 2021; see also review by O'Keefe, Krupic, 2021). While auditory cues are highly informative for our orientation and play a crucial role in creating a contextual picture of the current scene (reviewed e.g. in Bregman 1990, Pecka et al., 2020), their contributions to the formation of idiothetic maps has been more or less overlooked (O'Keefe, Krupic, 2021). Specifically, to what extent and how auditory cues and audio-spatial associations shape the internal spatial representation is not well investigated.

To gain understanding over the construction of auditory space and its influence on the spatial representation, we performed chronic multi-electrode recordings from the hippocampal area CA1 (place cells), retrosplenial and parietal cortices (head direction cells and egocentric vector representations) in freely-behaving Gerbils. By using an audio-spatial version of the Sensory-Island Task (SIT; Ferreiro, Amaro et al., 2020; Amaro et al., 2021) in both light and darkness enabled us to manipulate spatial cues and hence to introduce a conflict between the auditory spatial reference frame and the spatial map maintained by an idiothetic path integrator. Specifically, we investigate the degree of integration of independent position estimations given auditory and idiothetic reference frames. Additionally, we explore potential neural and behavioral correlates of spatially-relevant auditory landmarks, exemplified by direction or distance tuning to the location of the sound sources. Together, this project provides insight into the logic and mechanisms of auditory-based orientation and spatial representation.

Dissecting the function of different Dunc isoforms in *Drosophila melanogaster*

Timo Hasselmann¹, Marie Müller¹, Marcel Verbrüggen¹, Magdalena Gompert¹, Victoria Brüning¹, Henrike Scholz¹

¹Universität zu Köln, Department of Biology, Institute of Zoology, Zülpicher Straße 47b, 50674 Köln, Germany

Phosphodiesterases hydrolyze cAMP to 5'AMP and terminate cAMP-signalling. In the neuron, cAMP is important for the regulation of synaptic plasticity underlying learning and memory. Dunc (Dnc) is the only phosphodiesterase in *Drosophila melanogaster* that is cAMP-specific (Day et al., 2005). Dnc is required for olfactory aversive anaesthesia-resistant memory in adult *Drosophila* (Scheunemann et al., 2012; Tully and Gold, 1993). However already in the larval stage, *dnc* mutants perform worse than their genetic controls in olfactory aversive learning and memory experiments (Aceves-Piña and Quinn, 1979; Widmann et al., 2016).

dnc codes for eight confirmed transcripts (Ruppert, Franz et al., 2017). With this project we investigate the function of the different Dnc isoforms in olfactory learning and memory in *Drosophila* larvae. Our hypothesis is that there is not "the" phosphodiesterase Dnc but there are multiple isoforms with their specific function in neurons and in learning and memory. Most previous studies have been conducted using *dnc*¹, a mutant with altered expression of multiple *dnc* transcripts. The isolation of the *dnc*^{RA} specific mutant *dnc*^{Δ143} enable us to analyse specifically the function of the Dnc^{PA} isoform in learning and memory (Ruppert, Franz et al., 2017). Contrary to what was shown with *dnc*¹, Dnc^{PA}-deficient *Drosophila* larvae learn better and show long-lasting memory thus providing evidence for an isoform-specific function of Dunc in learning and memory. The repression of better learning requires the Dnc PDE-activity in a specific set of neurons suggesting that Dunc dependent regulation of different forms of learning and memory is required in different sets of neurons.

Dissecting the function of the PDE4D orthologue *Dunce* in olfactory learning and memory in the adult *Drosophila melanogaster*

Duran Emre Kanaci¹, Henrike Scholz¹

¹University of Cologne, Department of Biology, Scholz Group, Zùlpicher Straße 47b, 50674 Cologne, Germany

cAMP is hydrolyzed to 5'AMP by phosphodiesterases (PDEs). The cAMP-specific PDE *dunce* (*dnc*) encodes for at least eight isoforms with high homology to the human phosphodiesterase 4 class of PDEs (Ruppert, Franz et al., 2017). In this project, we investigate how the function of different Dnc isoforms varies in adult *Drosophila melanogaster* olfactory learning and memory. Our previous work suggests that Dnc phosphodiesterase isoforms differ in subcellular localization and cellular functions in different tissues in different developmental stages (Ruppert, Franz et al., 2017). Phenotypic characterization of different *dnc* mutants suggests that specific Dnc isoforms are required for short-term or long-term associative olfactory learning and memory in the larvae (see the abstract Hasselmann et al.). We investigate whether different olfactory memory phases mediated by the adult differentiated nervous system are Dnc dependent. We analyze the expression of *dnc* in the adult nervous system on the cellular and systems level in various approaches: We utilized Dnc::GFP fusion proteins under UAS-control and showed that different isoforms are expressed in different cellular compartments (Ruppert, Franz et al., 2017). We also analyzed the expression of several *dunce* promoter Gal4 driver lines using a UAS-mCD8::GFP transgene in different adult brain regions, such as the mushroom body, the antennal lobes, and the optic lobes. Additionally, we generated antibodies against particular Dnc isoform-specific peptides, and the initial analysis revealed that different isoforms are expressed in distinct subsets of neurons in the adult brain. We are generating new Dnc isoform-specific knock-outs to further characterize the function of Dnc isoforms in the adult brain and validate the Dnc isoform-specific antibodies. As a readout of the effect of altered Dnc function on olfactory learning and memory, we utilize associative and aversive short-term and long-term memory assays. We show that different *dnc* mutants perform differently in the adult behavioral assays, similar to what is observed in the developing nervous system. By combining behavioral, genetic, and molecular genetic techniques, we dissect the Dnc isoforms in olfactory learning and memory in the adult *Drosophila melanogaster*.

Projection-specific conjunctive coding of space, velocity, and appetitive behaviours by dorsal hippocampus

Oliver Barnstedt¹, Petra Mocellin¹, Stefan Remy¹

¹Leibniz-Institut für Neurobiologie, Cellular Neuroscience, Brenneckestraße 6, 39118 Magdeburg, Germany

Introduction:

Neurons in dorsal hippocampus (dHPC) encode a rich repertoire of task-relevant environmental features, while downstream regions such as the nucleus accumbens (NAc) need to translate this information into task-adaptive behaviours. However, the content of this information stream and its acute role in behaviour remain largely unknown.

Methods:

We used in vivo dual-colour two-photon imaging to simultaneously record from both large populations of hippocampal neurons and identified subsets of NAc-projecting neurons. During imaging, animals were engaged in a spatial reward navigation task.

Results:

We found that NAc-projecting neurons contain richer spatial information, overrepresenting both local cues and reward zone, in comparison to the general dHPC population. In the population of NAc-projecting neurons, we also found enhanced representations of non-spatial task-relevant behaviours, particularly appetitive licking. Strikingly, optogenetic activation of dHPC terminals in NAc specifically decreased the speed of locomotion and induced appetitive licking. Finally, a generalized linear model revealed enhanced conjunctive coding properties in NAc-projecting dHPC neurons. We show that these properties improve linear decoding of the reward location.

Conclusion:

Here, we show enhanced routing of conjunctive spatial, velocity and appetitive lick information from dHPC to NAc, which allows the NAc to guide task-appropriate behaviours.

Dissection of neuronal circuits underlying aversive olfactory second-order conditioning

El Yazid Rachad¹, André Fiala¹

¹University of Goettingen, Dept. of Molecular Neurobiology of Behavior, Julia-Lermontowa-Weg 3, 37077 Göttingen, Germany

Classical conditioning in *Drosophila* can be achieved by temporally pairing a conditioned stimulus (CS+), e.g. an odor, with an unconditioned stimulus (US) that mediates reward or punishment, such as sugar or electric shocks. The neuronal circuitry mediating this type of classical Pavlovian conditioning has been extensively studied, and neuronal circuits underlying aversive or appetitive olfactory learning have been characterized to a fair degree. However, the neuronal circuits mediating the formation of association chains through second-order conditioning (SOC) remains unknown. SOC can be achieved when a previously conditioned, aversively trained odor stimulus (CS+, now referred to as CS1) is paired with a second, novel odor stimulus (CS2), thereby transferring the learned, conditioned response to the CS2. This type of higher-order conditioning offers the opportunity to examine how the internal transfer of predictive information from CS1 to CS2 occurs at the cellular level. By selective thermo-genetic manipulation of distinct neuronal populations of the mushroom body circuitry during the different phases of first-order training, second order training or in the test situation, we dissected the neuronal circuits that are required for aversive second-order learning. Calcium imaging was used to visualize synaptic plasticity accompanying the distinct training phases. Overall, we characterize mushroom body-associated neuronal feedback loops that enable a learned odor stimulus to take control over punishment-mediating dopaminergic neurons, thereby mediating associative learning of higher order.

Dopamine's role as an inhibitor of dopaminergic neurons of the *Drosophila* mushroom bodies.

Michael-Marcel Heim¹, David Oswald¹

¹Charité Universitätsmedizin Berlin, Neurophysiologie, Charitéplatz 1, 10117 Berlin, Germany

Activity of dopaminergic neurons in higher animals, invertebrates and vertebrates alike, is critical for associative learning and motivation. In *Drosophila*, dopaminergic neurons strongly innervate the mushroom bodies. This higher order brain center is essential for olfactory learning and memory. Modulation of the mushroom bodies' circuitry has been intensely studied in the context of learning. However, it is still unclear whether interactions between dopaminergic neurons also play a role in learning. To address this, we performed focal dopamine injections onto dopaminergic neurons of the mushroom bodies. Using the genetically encoded voltage indicator ArcLight, we demonstrate that applying dopamine dendritically, hyperpolarizes dopaminergic neurons. Moreover, we provide evidence that this signaling cascade is mediated by the receptor Dop2R, which likely interacts with a G protein coupled inwardly rectifying potassium channel. Our results are reminiscent of mammalian Dop2R auto-receptor signaling, indicating an evolutionarily conserved role for Dop2R signaling in learning and reward driven behavior.

Drift and stabilization of hippocampal response selectivity

Alexander Schmidt^{1,2,3,4}, Fred Wolf^{1,2,3}, Yasunori Hayashi⁴, Kotaro Mizuta⁴, Masaaki Sato⁵, Julian Vogel^{1,2}, Bernhard Bandow^{1,2}

¹Campus Institute for Dynamics of Biological Networks, 37073 Göttingen, Germany

²Georg-August University, 37073 Göttingen, Germany

³Theoretical Neurosciences, Max Planck Institute for Dynamics and Self-Organization, Göttingen 37077, Germany

⁴Department of Pharmacology, Kyoto University Graduate School of Medicine, Kyoto 606-8501, Japan

⁵RIKEN Center for Brain Science, Saitama 351-0198, Japan

Place cells are a core functional characteristic of the hippocampal coding of space. Technological and methodological advances now allow for large scale and longitudinal recordings of neuronal activity. Accumulating evidence suggests that various hippocampal regions display a turnover of place cell coding with a timescale on the order of days and weeks. While the overall dynamics and its possible function has received substantial attention, the individual dynamics of the cells' place fields remain incompletely characterized.

We analyzed two-photon activity imaging data of neurons in the hippocampal CA1-region of behaving mice (Fig. a)) unidirectionally navigating a linear, circular virtual environment in which they encountered visual, as well as reward stimuli at fixed locations, Fig. b).

Characterizing the neurons activity in each of up to 100 sessions into place-coding and non-coding behavior, while simultaneously assessing whether neurons turned silent allows us to create complete traces of individual neuron behavior over the whole experiment (Fig c,d)). Changes between these different states occur non-random and we specifically find that

1. the identity of neurons in the active population gradually changes, maintaining above chance level for the recurrence of activity in a neuron for several weeks to months
2. place field recurrence in neurons follows a non-diffusive pattern, with short range stability (remaining in a closely circumscribed region of space) and a probability of random relocation, Fig. e)
3. place field stability appears to be impacted by Hebbian, as well as non-Hebbian mechanisms, with the probability of recurrence decreasing with the number of non-coding sessions in between, but being slightly, though significantly recovered when a neuron remains silent, Fig. f)

In conclusion, we find that place field dynamics in CA1 consists of localized random motion, interrupted by long-range random relocation (2), happening within a substrate of a slowly changing active population (1). Contributions of both, spontaneous synaptic turnover, as well as Hebbian, activity-based turnover may be underlying the overall dynamics (3), calling for further, directed experiments to uncover the details of hippocampal place field dynamics.

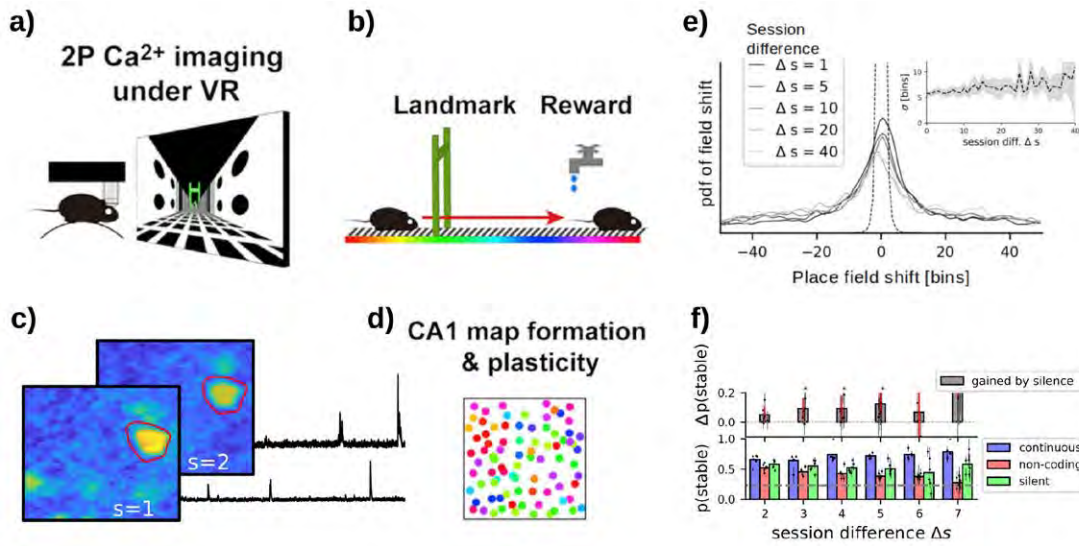

a) sketch of the setup; b) the VR with visual and reward cues; c) neuron location and activity is extracted to obtain d) the location of place fields (ref. colors in b)), e) place field shifts show a non-diffusive pattern, f) periods of non-coding activity are associated with place field turnover

Effect of internal states on memory consolidation in *Drosophila*

Sridhar rajan Jagannathan¹, Davide Raccuglia¹, David Oswald¹

¹Institute of neurophysiology, Charité Universitätsmedizin Berlin, Charitéplatz 1, 10117 Berlin, Germany

Recent findings have revealed different forms of appetitive memory consolidation, while memory consolidation in fed flies was dependent on sleep and those in hungry flies were found to be independent of sleep. Thus elucidating 'not all memory needs sleep'. However very little is known about the effect of how several internal states like thirst, hunger and sleep drive interact and interfere with appetitive/aversive memory consolidation. Particularly, how optogenetically induced sleep interferes with memory consolidation processes is largely unknown. Here, we will explore how artificially induced appetitive/aversive memories are influenced by factors like sleep deprivation, optogenetically induced sleep, hunger, thirst and other internal states. We will also probe the specific post-learning time interval under which sleep should be necessary and sufficient to consolidate memory. Furthermore, we will also probe the similarities between induced and spontaneous sleep in terms of different forms of memory consolidation.

Effect of NPSR1 deficiency on T-maze and Barnes maze learning

Ahmet Oguzhan Bicakci^{1,2,3}, Evelyn Kahl², Malgorzata Kolodziejczyk², Luibov Kalinicheno⁴, Markus Fendt^{2,5}

¹ Integrative Neuroscience Program; ² Institute for Pharmacology and Toxicology; ³ present address: Behavioral Neuroscience, University of Marburg; ⁴ University of Erlangen- Nürnberg; ⁵ Center for Behavioral Brain Sciences, Otto-von-Guericke University Magdeburg, Magdeburg, Germany.

Neuropeptide S (NPS) is a short neuropeptide, expressed in a restricted region between the locus coeruleus and Barrington's nucleus, while its receptor, NPSR1, is expressed in wide range of brain areas, such as, anterior olfactory nucleus, basal ganglia, limbic system, and hippocampus. Published data indicate that the NPS/NPSR1 system is involved in anxiety, stress, arousal, learning, and cognitive flexibility. The aim of this study was to investigate the role of the NPS system on T-maze and Barnes-maze learning using NPSR1 knock-out mice. First, mice had to learn a simple T-maze task, i.e., that one of the two T-maze arms were baited with a food reward. After five sessions with 10 trials each, reversal learning was performed with five further sessions. In the end of both acquisition phase and reversal phase, the learning strategy (allocentric vs. egocentric) was determined. Second, the mice were trained on the Barnes maze consisting of a plate with 20 holes on the border having an escape box underneath one of the holes. The mice had to learn the location of the escape box. Last, the effects of NPSR1 deficiency on monoamine levels in brain were measured with ex vivo High-Performance Liquid Chromatography (HPLC). NPSR deficiency improved acquisition of T-maze learning but had no effects on its reversal. While wildtype and heterozygous mice mainly used an egocentric learning strategy during acquisition, NPSR1-deficient mice prioritized an allocentric strategy. The Barnes maze data are currently analyzed and will be shown at the conference. Further, the HPLC analyses showed several changes in noradrenaline (NA), dopamine (DA) and serotonin (5-HT) in the different brain areas, including an upregulation of NA, DA and 5-HT in the hippocampus and striatum of heterozygous NPSR1-deficient mice, a downregulation of NA in the nucleus accumbens and prefrontal cortex of homozygous NPSR1-deficient mice, and an upregulation of DA in the amygdala of male heterozygous and homozygous NPSR1-deficient mice. Taken together, our findings support published data showing that the NPS/NPSR1 system is involved in learning and memory. Furthermore, NPSR1 deficiency affects monoamine levels in different brain areas.

Effects of pyrethroids on honey bee olfactory perception, learning and processing

Loïc Colin-Duchevet¹, Clémentine Hatton¹, Antoine Couto², Claude Collet³, Pierre Charnet⁴, Jean-Christophe Sandoz¹

¹Evolution, Genome, Behavior and Ecology, CNRS, IRD, University Paris-Saclay (UMR9191), Gif-sur-Yvette, France.

²School of biological science, University of Bristol, UK.

³UR406 Bees and Environment, French National Institute For Agriculture, Food and Environment, INRAE, 84914 Avignon, France.

⁴Intitut des Biomolécules Max Mousseron, Université de Montpellier, CNRS, ENSCM, Montpellier, France.

Honey bees are described as keystones of our ecosystems and are responsible for about 80% of the pollination of plant species used by humans. Unfortunately, bee populations have shown a significant decrease over the years due to many factors including climate change, habitat fragmentation but also pesticide use.

The effects of pesticides on honey bees have been studied for many years, and it was demonstrated that some strongly impair honey bee olfactory perception, learning and memory, key abilities for their foraging behavior and pollination service. However, previous studies almost exclusively focused on the well-known neonicotinoids. In comparison, pyrethroids, which are insecticides used since the 80s, are known to be highly toxic for bees but their effects on honey bee olfactory perception and memory are poorly known.

The purpose of this study was to determine the effect of sublethal doses of a pyrethroid (cypermethrin) on honey bee perception, learning and memory. To this aim, we used the conditioning of the proboscis extension response (PER), which reproduces in the Lab the final step of bees' foraging behaviour, when they learn to associate a floral odor with a nectar reward. These behavioural experiments showed that sublethal doses of cypermethrin applied topically impair both olfactory acquisition and discrimination performances. Thanks to in vivo calcium imaging, we are currently analyzing the effect of cypermethrin on odor-induced activity in the antennal lobe, the primary olfactory center of the honey bee brain.

In-vivo imaging of cAMP dynamics: Subcellular compartmentalization underlying learning and memory.

Stephan Hubertus Deimel¹, André Fiala¹

¹University of Goettingen, Dept. of Molecular Neurobiology of Behavior, Julia-Lermontowa-Weg 3, 37077 Göttingen, Germany

In the *Drosophila* central brain, the mushroom body (MB) mediates olfactory learning and memory. During classical conditioning, odor inputs are conveyed by projection neurons (PNs) to the Kenyon cells (KCs) of the MB, and the coincidence of the activation of dopaminergic neurons (DANs) by the reinforcement (punishing or rewarding) along with this odor input leads to an alteration in the plasticity of the synapses with the mushroom body output neurons (MBONs) and thus behavior.

Here, the second messenger cAMP plays a crucial role in this plasticity, mediated by the adenylyl cyclase rutabaga (Rut) and its counterpart the phosphodiesterase dunce (Dnc). While it is established that dnc maintains spatial specificity between lobes, the influence on compartmentation within the lobes, especially on the single neuron level remains unknown.

We want to elucidate this influence by addressing two objectives: The localization of phosphodiesterase Dnc within single neurons and its influence on cAMP concentrations to understand the role of KC synaptic boutons as individual functional units in learning and memory.

Evaluation of six new Octopamine Trojan Exon mutants

Alexandra Großjohann¹, Ronja Badelt¹, Dennis Pauls², Andreas Thum¹

¹University Leipzig, Faculty of Life Sciences, Institute of Biology, Genetics Department, AG Thum, Talstr. 33, 04103 Leipzig, Germany

²University Leipzig, Faculty of Life Sciences, Institute of Biology, Physiology Department, AG Kittel, Talstr. 33, 04103 Leipzig, Germany

The invertebrate equivalent of noradrenaline, octopamine, has been reported to play a role in a wide spectrum of physiological and behavioral processes. Accordingly, in adult and larval *Drosophila* octopamine and its related receptors are analyzed to gain further mechanistic insight into the nervous system. The novel genetic tool 'Trojan Exon' by Diao et al. (2015) utilizes a *Minos* mediated integration cassette (MiMIC) and viral T2A factor to promote the translation of a reporter protein product and the related gene of interest from a single transcript. Depending on the insertion site in the gene, a truncated, mutated version of the protein results. However, the expression of the reporter should correspond to the endogenous expression of the related gene. Behavioral analysis of 6 new Trojan Exon octopamine and octopamine receptor lines available at Bloomington stock center shows that only some of the described effects can be reproduced. Our molecular analysis reveals that in one case this was based on the absence of the Trojan Exon. The new mutants were used to investigate the role of octopamine in larval appetitive learning. Overall, we recommend the Trojan Exon method as a possible alternative to perform gene-behavior correlations in *Drosophila* larvae. However, before experiments can be performed, the molecular organization of the respective construct must be verified.

Eye blink is an excellent measure for spatial learning in human

Motoharu Takao¹

¹Tokai University, Department of Human and Information Science, 4-1-1 Kitakaname, 259-1292 Hiratsuka, Japan

Spatial learning is an inevitable brain function for survival in daily life. Recent advancement of virtual reality (VR) technology enables researchers to investigate psychophysiological changes in virtually real environments. In this study, we investigated the effect of three dimensional (3D) spatial learning on eye blink in visual environment that was generated by computer graphics. The results showed that eye blink rate increased depending on spatial learning trials, but decreased after learning was completed. Our findings indicate that eye blink can be a good measure for spatial learning.

Female vocal feedback improves song learning and alters premotor activity in juvenile zebra finches

Linda Bistere¹, Daniela Vallentin¹

¹Max-Planck-Institut für Biologische Intelligenz, 82319 Seewiesen, Starnberg, Germany

Learned motor behaviors are often shaped by social influences. For instance, human infants learn to speak through the process of observational learning, imitating and integrating parental feedback. Young zebra finches learn their song from their fathers in a similar manner. Since female zebra finches do not sing, their contribution to song learning has been largely neglected. To investigate the role of female zebra finches on juvenile song learning, we used an operant conditioning paradigm to train young male zebra finches to imitate a song playback. The juvenile birds were housed in two different social contexts: in isolation or together with a female bird. Both groups were tutored with the same tutor song that birds elicited themselves via key pecks. We tracked the song learning trajectories of juveniles in both groups and found, that female presence during the song learning phase increased the similarity of learnt song to the tutor song. Furthermore, the syllable rate of the tutor song was best matched by the group housed with a female. Although female birds do not sing, they produce calls which can be the source of auditory feedback to guide juveniles' song learning. To explore whether female vocalizations have the potential to elicit changes in the premotor circuitry necessary for song learning and production, we performed intracellular recordings in awake, listening juvenile birds in the premotor area HVC (proper name). A subset of HVC premotor neurons modulated their spiking activity in response to female calls. Additionally, spiking precision was increased when birds own song playback was accompanied with a female call. In adults, it has been shown that female call presentation during birds own song does not change the spiking activity of HVC premotor neurons. To investigate the developmental change responsible for this switch, we performed intracellular recordings in adult birds under anesthesia, a state of decreased inhibition. In this case we found that the time-locked responses to the female calls during birds own song playback reemerged even in adult birds. Together these data suggest, that the presence of a female during song learning leads to increased tutor song matching performance and that female vocalizations have the potential to elicit changes in premotor circuitry leading to song improvements in learning juvenile birds.

fMRI reveals learning induced changes in auditory-evoked brain activation patterns in the Mongolian gerbil

Annika Michalek¹, Patricia Wenk¹, Nicole Angenstein¹, Eike Budinger^{1,2}

¹ Leibniz Institute for Neurobiology, Combinatorial NeuroImaging Core Facility, Magdeburg

² Center for Behavioural Brain Sciences, Magdeburg

Auditory learning has shown to induce plasticity changes in the auditory cortex (AC) in the Mongolian gerbil using various paradigms like discrimination learning of frequency-modulated tones (FMs). However, related *in vivo* changes in whole brain activation patterns were never reported before. Here, we show by means of auditory-stimulated high-field functional magnetic resonance tomography (fMRI) that FM discrimination learning induces changes in activation patterns in auditory and other brain structures of this species.

Adult male gerbils were trained to discriminate between rising (Go: 1-2kHz) and falling (NoGo: 2 1kHz) FMs in ten daily sessions, promoted through punishment with a mild electrical foot shock for a “Miss”. Prior, after 3 and 10 sessions auditory-stimulated BOLD fMRI was performed at 9.4T field strength (Bruker 94/20 UHF) with an optimized GE-EPI sequence. During the scanning procedure, the gerbils were anaesthetized with 0.4 mg/kg/h medetomidine. For auditory stimulation and background attenuation, tubes with pliable earplug tips were placed in the outer ears of the animals; the Go and NoGo tone as well as a control tone (alternating 3-6 kHz and 6-3 kHz FMs) were presented in a pseudorandomized block design. A group GLM with Bonferroni correction ($p < 0.05$) was performed on the preprocessed data with BrainVoyager and a 2way-ANOVA was implemented for comparison between measurements.

The learning performance of the gerbils surpassed a d' value of 1.4 [$d' = z(\text{Hit}) - z(\text{False Alarm})$] in average in the third training session, with no further significant improvement throughout the remainder of the training. Auditory-stimulated fMRI revealed BOLD contrast in the complete central auditory pathway including both AC, medial geniculate nuclei and inferior colliculi. After 3 and after 10 training sessions, increased midbrain activity with additional BOLD contrast in the lateral posterior thalamic nuclei, as well as in the retrosplenial and cingulate cortex were observed for the Go tone, and to a lesser extend for the NoGo tone but not for the control tone. Statistical comparison revealed those BOLD contrast increases to be significant for the Go tone stimulation only. In the right AC, responsible for the direction discrimination of FM tones, a significant decrease of BOLD intensity was observed for the Go and NoGo tone in the 2nd and 3rd fMRI measurement, but not the control tone, which hints at a lowered metabolic cost due to plasticity changes.

For the first time we showed learning-induced changes of auditory-evoked brain activation patterns in the Mongolian gerbil on a whole brain level with fMRI. Through this method, not only a reduced metabolism in the AC was observed, but additional activation in networks known for attention and memory induced by the discrimination training. Overall, the results of this study show the potential of auditory-stimulated fMRI in the gerbil for disentangling learning mechanisms on a whole brain level.

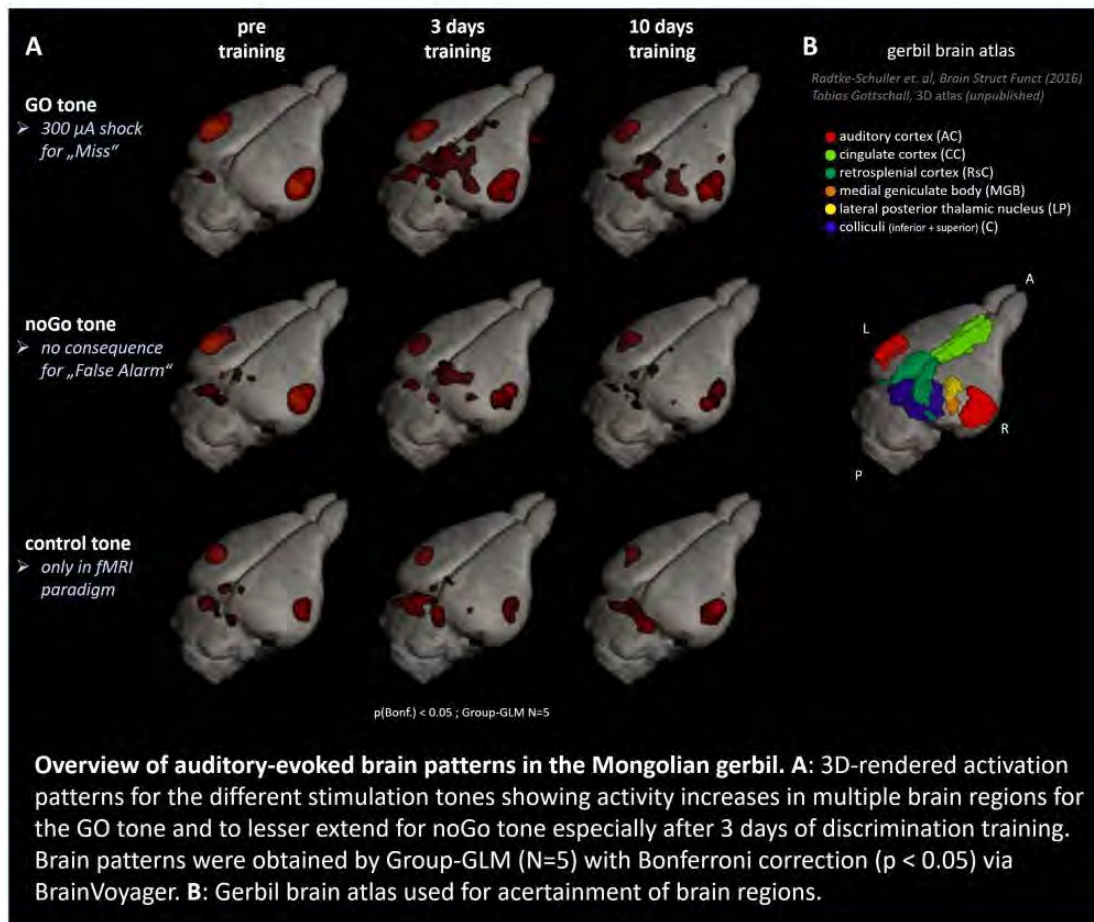

Overview of auditory-evoked brain patterns in the Mongolian gerbil.

From connectomic to behavioural complexity in larval *Drosophila*?

Edanur Sen¹, Juliane Thöner¹, Arman Behrad¹, Melissa Comstock¹, Nina Jacob¹, Amira El-Keredy^{1,2}, Nino Mancini¹, Bertram Gerber¹

¹Leibniz Institute for Neurobiology, Genetics of Learning and Memory, Brenneckestraße 6, 39118 Magdeburg, Germany

²Tanta University, Department of Genetics, Al-Geish Street, Tanta, Egypt

Larval *Drosophila* are an established model system for many questions in the behavioural neurosciences, including associative learning and memory (Thum and Gerber 2019). Recently, the dense electron microscope reconstruction of the memory center of the larval brain (Eichler et al. 2017) has revealed that more than half of the types of chemical-synapse connections had previously escaped attention, a result confirmed in adult flies (Takemura et al. 2017). This unexpected connectomic complexity begs the question whether a corresponding complexity can be uncovered in the complexity of learning capabilities in these animals. In this context, we investigate whether larvae show hallmarks of cognition-like associative processing, namely sensory preconditioning, second-order conditioning, and conditioned inhibition in odour-taste types of learning assays.

References:

Thum, A. S. & Gerber, B. (2019). Connectomics and function of a memory network: the mushroom body of larval *Drosophila*. *Current opinion in neurobiology*.

Eichler, K. (2017). The complete connectome of a learning and memory centre in an insect brain. *Nature*.

Takemura, S. Y. (2017). A connectome of a learning and memory center in the adult *Drosophila* brain. *Elife*.

Holistic Bursting Cells as an Auditory Engram

Hongbo Jia¹

¹Leibniz Institute for Neurobiology, Combinatorial NeuroImaging, Brennekestrasse 6, 39118 Magdeburg, Germany²Brain Research Instrument Innovation Center, Suzhou Institute of Biomedical Engineering and Technology, Chinese Academy of Sciences, Suzhou 215163, China.³Advanced Institute for Brain and Intelligence and School of Physical Science and Technology, Guangxi University, Nanning 530004, China.⁴Institute of Neuroscience and the SyNergy Cluster, Technical University Munich, 80802 Munich, Germany

Sensory neocortex has long been believed to be essential for long-lasting memory storage. However, the cellular embodiment of memory engram in sensory neocortex has not yet been discovered. Here, in mice through a voluntary auditory learning experience, we found the spike firing of a sparse population of (2~3%) neurons in layer 2/3 auditory cortex emerged from quiescence into 'holistic bursting' mode. Once emerged, these cells persisted with bursting responsiveness specifically to the learned sounds. Local microinjection of aqueous isoflurane solution reversibly blocked the bursting outputs of these cells and the learned sound-associated licking behavior, while the average responsiveness of non-bursting cells remained unaltered. Most of these cells became quiescent through experiencing condition dissociation and then reinstated bursting responsiveness through re-association. Together, holistic bursting cells satisfy all the four engram defining criteria originated from Richard Wolfgang Semon, and thus can be regarded as an engram of the learned behaviorally relevant sounds in the auditory cortex.

How interneurons shape behavior: The impact of DNA methyltransferase 1 (DNMT1) on inhibitory cortical interneurons of behaving mice

Jenice Reimara Nicola Linde^{1,2}, Can Bora Yildiz^{1,2}, Julia Reichard^{1,2}, Georg Pitschelatow^{1,2}, Geraldine Zimmer-Bensch^{1,2}

¹RWTH Aachen University, Department for Neuroepigenetics, Worringerweg 3, 52074 Aachen, Germany

²RWTH Aachen University, Research Training Group 2416 MultiSenses - MultiScales, Worringerweg 3, 52074 Aachen, Germany

The mammalian cerebral cortex, the seat of higher cognitive function, is characterized by a sensitive balance between excitation and inhibition. This balance resembles a key element of the cortex' function, enabling proper information processing. Although interneurons constitute, in comparison, a minority, their function sets the tone. The input of interneurons is crucial to synchronize surrounding neuronal activity and thus modulate circuit activity. A shift of interneuron abundance and/or function in any direction does usually result in severe consequences for the whole organism. For example, this shift can result in neurodevelopmental or neuropsychiatric diseases, such as schizophrenia and autism. Next to genetic causes, environmental stimuli, often in specific phases of brain development, have a great impact on disease onset and severity. Thus, epigenetic mechanisms of transcriptional control were recently moved into the focus of research. Especially, the epigenetic regulation of interneuron development and function represents a disease-relevant topic of interest.

Here, we investigated the role of the DNA methyltransferase 1 (DNMT1) in different types of inhibitory cortical interneurons. Previous work of our group revealed a role of DNMT1 in clathrin-mediated endocytosis of parvalbuminergic interneurons, thus influencing GABAergic transmission. To further unravel the involvement of DNMT1 in GABAergic interneuron functionality, we performed behavioral tests on different *Dnmt1*-knockout (KO) mouse strains. Utilizing Cre-Lox recombination, we created strains, which have the *Dnmt1*-KO restricted to either their *Gad2*-, *Pv*- or *Sst*-expressing interneurons. While basic sensory and motoric skills largely remained intact, higher cognitive functions, such as visuo-spatial learning in a Morris water maze, were shown to be altered by the *Dnmt1*-KO in *Gad2*-expressing interneurons, and to some extent also in *Pv*-expressing cells.

Impaired pattern completion during memory recall in an adult mouse model of fragile X Syndrome

Caroline Zeitouny¹, Martin Korte^{1,2}, Kristin Michaelsen-Preusse¹

¹Division of Cellular Neurobiology, Zoological Institute, TU Braunschweig, Germany.

²Helmholtz Center for Infection Research, Research group Neuroinflammation and Neurodegeneration, Braunschweig, Germany.

The Fragile X Syndrome (FXS) is the leading monogenetic cause of cognitive impairment and autism. FXS symptoms include excessive adherence to patterns indicating perturbed hippocampal networks. The hippocampus is involved in pattern separation/completion processes during memory formation. Especially the CA3 region is of interest because of its auto-associative recurrent inputs. The absence of the fragile X mental retardation protein (FMRP) in patients and *Fmr1* KO mice leads to an abnormal development of dendritic spines, which form the postsynaptic compartment. Recently, we showed that different synapse types on CA3 neurons are affected differently by the absence of FMRP. While mossy fiber inputs to CA3 neurons are transiently premature during the fourth postnatal week, collateral/commissural inputs onto regular spines are increased in number in adult animals. Therefore, we were interested whether this would result in specific impairments in information processing in CA3 neurons during adolescence (P24-44) and in adult (3-7 months) animals. The CA3 region plays a pivotal role in pattern completion processes important for efficient memory recall even from parts of the initial memory stimulus. We therefore subjected adolescent and adult *Fmr1* KO mice to spatial training in the Morris water maze task and performed partially cued probe trials by selectively removing spatial cues. Consistent with the collateral spine phenotype observed in adult animals, we can show an impairment in pattern completion in adult and not in adolescent animals. It has been shown that spatial training or a general enrichment can enhance formation of proper neuronal connections in the FXS mouse model. Therefore, adolescent mice were subjected to either specific spatial training using Morris water maze and Barnes maze or general enrichment. Only the specific spatial training alleviated the cognitive symptoms and the spine phenotype shown in adult *Fmr1* KO mice.

Mechanisms of memory consolidation in *Drosophila melanogaster*

Tania Fernandez d.V. Alquicira¹, Lisa Scheunemann¹, Desiree Laber¹, David Oswald¹

¹Institut für Neurophysiologie, Charité, 10117 Berlin

Memory allows the storage and retrieval of acquired information. Memories are encoded as specific cellular changes, product of the stabilisation of synaptic plasticity after learning.

The location of olfactory memories in *Drosophila melanogaster* is well known, and the availability of genetic tools permits the dissection of the circuit underpinnings associated with different stages of memory, e.g. during consolidation, storage and retrieval.

In *Drosophila*, the mushroom bodies (MBs) are involved in storing different elements of reward and punishment associative memories. Our work now shows that blocking synaptic output of M4/6 MB output neurons interferes with memory consolidation, reverting aversive to appetitive memories. We show that this memory is distinct from appetitive sugar memories as it is not gated by the animal's hunger state. Moreover, in vivo imaging reveals that aversive training triggers ongoing activity in M4/6 MB output neurons, indicating post training network activity. Thus, post training interventions of single neuron output can reprogram circuit activity and change memory outcome.

Mitochondrial function in dopaminergic neurons influence olfactory learning and memory in *Drosophila melanogaster*

Michèle Tegtmeyer¹, Justin Böcker¹, Anica Biermann¹, Sabrina Peter¹, Melissa Beste¹,
Henrike Scholz¹

¹University of Cologne, Department for Zoology, study group Scholz, Zülpicher Straße 47b, 50674 Cologne, Germany

With aging population, neurodegenerative diseases like Parkinson's disease become more prevalent. Neurodegeneration is associated with memory decline. Neurodegenerative diseases are often caused by dysregulation of mitochondria function and are associated with decline of dopaminergic neurons. To understand how neurodegeneration affects memory decline, we analyzed the function of mitochondria in dopaminergic neurons in *Drosophila melanogaster*. We focus our analysis on the function of Miro, a mitochondrial protein, which regulates several aspects of mitochondrial function such as, Ca²⁺ homeostasis, mitochondrial transport or fusion/fission processes. In addition, Miro interacts with neurodegenerative diseases associated proteins like Parkin and Tau. A great model to investigate early symptoms of neurodegenerative diseases, such as memory loss, is the olfactory classical (Pavlovian) conditioning in *Drosophila melanogaster*. Here, dopamine mediates the reinforcing properties of the conditioned odorant. We provide evidence that mitochondria have different functions in different sets of dopaminergic neurons. Knockdown of Miro in a broad set of dopaminergic neurons increased aversive short-term (STM) and long-term memory (LTM) before onset of neurodegeneration. Aging of flies did not result in severe memory loss when Miro is altered in this set of dopaminergic neurons. In contrast, reduction of Miro function in another small subset of dopaminergic neurons resulted in impaired LTM. The increased memory does not require Miro function, supporting that axonal transport is not required for the regulation of memory. We provide evidence, that Tau together with Miro might regulate the enhancement of memory. Furthermore, it seems that Miro in its role for mitophagy is not essential for the early onset memory loss or increase, since reduction of Parkin in dopaminergic neurons did not result in learning and memory early in adult life. We provide evidence that Miro together with Tau regulates mitochondrial function underlying the morphology of dopaminergic neurons correlating with memory changes, but not neurodegeneration.

Neonatal olfactory processing is necessary for the maturation of limbic-hippocampal network and cognitive development

Yu-Nan Chen¹, Johanna K. Kostka¹, Sebastian H. Bitzenhofer¹, Ileana L. Hanganu-Opatz¹

¹Institute of Developmental Neurophysiology, Center for Molecular Neurobiology, University Medical Center Hamburg-Eppendorf, 20251 Hamburg, Germany

Cognitive processing requires directed interactions between several brain areas of the limbic system, such as the hippocampus (HP) and lateral entorhinal cortex (LEC). In the adult brain, these interactions are modulated by multiple sensory systems. During early development, when mice are blind, deaf, do not whisker and have poor motor abilities, the fully functional olfactory system might have a particular impact on HP and LEC. We previously showed that neonatal olfactory activation boosts the oscillatory entrainment of LEC via mono- and polysynaptic projections from the olfactory bulb (OB). However, the long-lasting impact of olfactory inputs on the limbic function and cognitive abilities of later life is largely unknown. Thus, we chemogenetically inhibited the synaptic outputs of mitral/tufted cells (M/TCs), the main projection neurons in the OB, during postnatal days 8-10 and monitored the long-lasting consequences on the downstream areas LEC and HP, and on cognitive performance. *In vivo* extracellular recordings revealed that after the transient inhibition of the olfactory output, the oscillatory activities of downstream areas were diminished along development, in line with the long-lasting decrease in the dendritic complexity of HP-projecting pyramidal neurons in LEC. Correspondingly, pre-juvenile mice experiencing early life manipulation had declined performance in cognitive tasks. These results indicate that the early olfactory processing before eye-opening might be critical for the functional development of cognitive abilities.

Neural circuits that regulate exploratory odor-driven behavior

Giovanni D`Uva¹, Christian Daniel¹, Maria Loannidou¹, Leticia Batista¹, Carlotta Martelli¹

¹Johannes Gutenberg-Universität Mainz, Institute of Developmental Biology and Neurobiology (iDN) - Martelli Lab, Hanns-Dieter-Hüsck-Weg 15, 55128 Mainz, Germany

The ability to display different behaviors according to changes in the environment is crucial for animal survival. Some behaviors however are innate, as attraction to the smell of food or avoidance of mouldy food. These instinct-driven behaviors rely on expectations, that however, are not always fulfilled. In this circumstance, the animal's brain has to override an evolutionary encoded behavior to switch to new strategy for achieving its goal (e.g. finding food). Yet, on which timescale these computations happen and which neural circuits are involved in this change remains unclear.

In *D. melanogaster*, two different brain structures, the mushroom body (MB) and the lateral horn (LH) are responsible for the encoding of learned and innate odor preferences, respectively.

The MB is innervated by two different clusters of dopaminergic neurons (DANs): the posterior lateral protocerebrum (PPL1), needed for aversive learning and the protocerebral anterior medial (PAM), required for reward learning. The current model proposes that a learned approach or avoidance behavior is promoted by the combination of mushroom body output neurons (MBONs) output drive with a reduced avoidance for appetitive learning and a reduced approach for aversive learning. During learning, sensory information is integrated with other contextual events, such as rewards or punishments, via the dopaminergic neurons innervating functionally distinct MB compartments. The dopamine release induces depression on specific Kenyon cells (KCs)-MBONs synapses leading to a modification in the MBONs' predictive odor value representation.

We hypothesise that the switch from pursuing the odor to the exploration of the surroundings arises from a constant update of the odor's value accomplished by DANs within the mushroom body. In this way, the MB could re-evaluate the innate value encoded by the LH thus driving the behavioral adjustment.

Here we show that the MB is needed for flexibility in exploratory odor-driven behavior. The silencing of the MB made flies unable to re-evaluate the odor value leading to a continuous approach over time. In addition, the blockade of the dopaminergic system, particularly the silencing of PAM cluster, is recapitulating the same effect inferring a crucial role for DANs in behavioral flexibility.

Furthermore, using 2p calcium imaging, we found that several DANs from the two clusters, respond to stimulation with innate appetitive or aversive odors. Their responses are strongly compartment-specific, especially for their dynamics. PPL1 neurons seem to respond independently of odor identity while PAM neuron responses are more odor specific. In addition, several DANs exhibit a diverse decay time in response to sustained odor stimulation, offering a possible mechanism for updating the odor value over time.

Altogether, this data suggests that the MB and more specifically DANs are playing a crucial role in reporting and updating the behavioral outcome over time to direct the animal towards the most profitable exploration strategy.

Neural correlates of cooperation in freely moving rhesus macaques

Melissa Franch¹, Sudha Yellapantula², Anthony Wright¹, Valentin Dragoi^{1,2}

¹UTHealth, Neurobiology and Anatomy, 6431 Fannin st., 77030 Houston, USA

²Rice University, Neuroengineering, 6100 Main st., 77005 Houston, USA

Social interactions are essential for the well-being and survival of humans, non-human primates, and other animals. Specifically, cooperation is an extremely complex social behavior, involving the perception and monitoring of self and others' actions to determine productive responses towards achieving a common goal. Despite such behavioral intricacy, most of our knowledge about the role of social attention in cognition originates from studies performed in restrained animals viewing synthetic stimuli on a monitor. Consequently, our understanding of how the brain processes naturalistic, visual-social cues to facilitate volitional social decision-making remains limited. Here, we examined the neural correlates of cooperation by wirelessly recording eye-tracking and neural activity from a visual-social cortical network – visual area V4 and dorsolateral prefrontal cortex, dlPFC – while dyads of freely moving and behaving rhesus macaques cooperated for a food reward. In this task, the same perceivable but remote reward was revealed to each animal, and animals could obtain their reward by, at any time, simultaneously pushing and holding buttons which would move trays that delivered reward. Critically, the timing of animals' push responses with respect to each other reveals their actions are coordinated, not random, and monkeys across dyads exhibited a high conditional probability to cooperate ($P(\text{self} | \text{partner}) > 0.5$). Additionally, animals are more likely to fixate on social cues, such as the reward or partner monkey, before cooperation than during non-socially relevant periods. Importantly, neuronal ensembles in V4 and dlPFC encode these social cues, while population encoding of self and partner decision to cooperate was greatest in dlPFC. Finally, significantly correlated V4-dlPFC cells contribute more to encoding of social variables within each area. Together, these findings reveal a distributed cortical network representation of visually driven cooperation in the primate brain.

Neuromodulator-dependent two-phase synaptic plasticity retroactively controls neural coding in spiking neural networks

Jannik Luboeinski^{1,2}, Andrew B. Lehr^{1,2}, Christian Tetzlaff^{1,2}

¹Institute for Neuro- and Sensory Physiology, University Medical Center Göttingen, Department of Computational Synaptic Physiology, Von-Siebold-Str. 3a, 37075 Göttingen, Germany

²III. Institute of Physics - Biophysics, University of Göttingen, Department of Computational Neuroscience, Friedrich-Hund-Platz 1, 37077 Göttingen, Germany

In the brain, groups of neurons with particularly strong synaptic connections can represent memories at the network level. These so-called Hebbian cell assemblies are formed by synaptic plasticity. Subsequently, they can become consolidated by the mechanisms of synaptic tagging and capture (STC), influenced by diverse neuromodulatory signals. In order to characterize the impact of these mechanisms on long-term memory, their functional role at the level of neuronal networks needs to be understood.

To this end, we have employed a biologically detailed model of a recurrent network of spiking neurons, featuring synaptic plasticity and neuromodulator-dependent STC. Thereby, we could model and investigate the learning, consolidation, and recall of long-term memory representations. In the present study, we consider variations in the protein synthesis required for STC, driven by the concentration of an abstract neuromodulator. We model this by assuming a monotonic relationship between neuromodulation on the one hand and the amount of produced proteins on the other hand.

Our modeling results lead to two main predictions: 1. by influencing the synthesis of plasticity-related proteins, neuromodulator concentration may serve to retroactively select a subset of synaptic connections in the network to become stabilized; 2. the neuromodulation-dependent synaptic changes influence spiking dynamics, ultimately controlling which type of neural code is used to store information about an experienced stimulus. Specifically, we find better recall of temporal structures for strong neuromodulation, while we find better recall of rate-coded spatial patterns for lower neuromodulation, mediated by the selection of different groups of synapses for consolidation. We quantify these effects by using different measures of recall performance derived from the neuronal spiking activity in the network.

In summary, by considering STC along with other synaptic and neuronal mechanisms, we have developed a network model that makes use of one fast plasticity mechanism as well as one slow, neuromodulator-dependent, plasticity mechanism, enabling rich cognitive functionality. Our recent results essentially suggest that in the minutes to hours after learning, neuromodulation may alter the functional properties of neural networks to ultimately control which type of information becomes consolidated. This may provide an explanatory basis for known long-term memory effects such as switching between the storing of semantic and episodic information.

Spiking network model with early- and late-phase plasticity

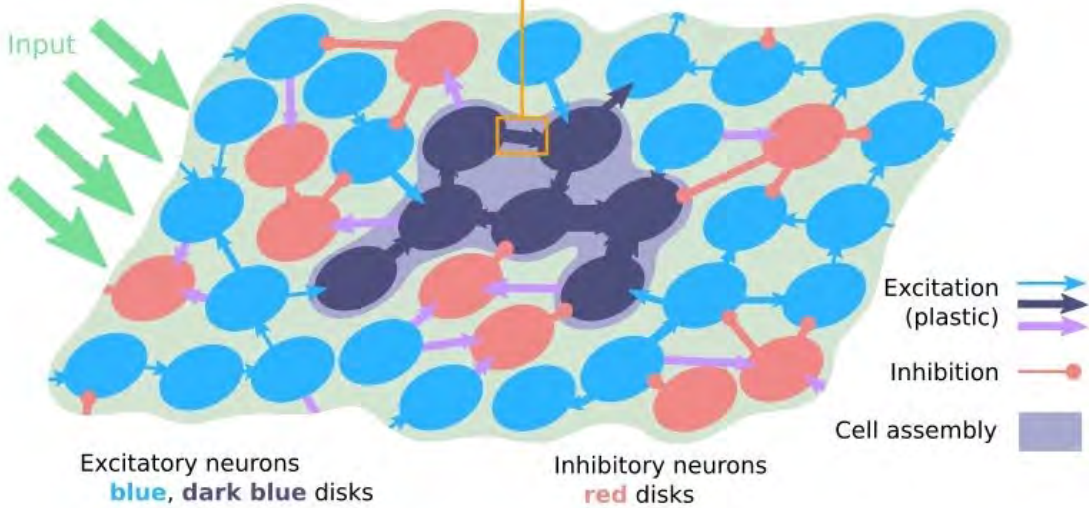
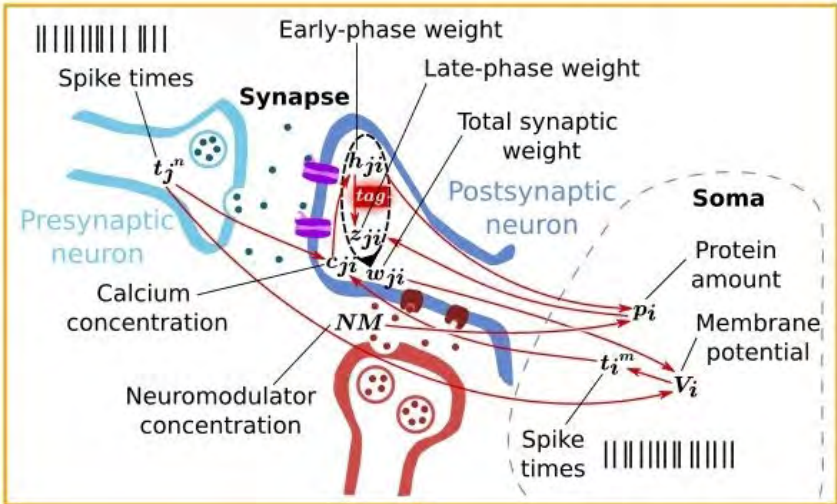

Perception of optogenetic cortex stimulation is modality-specific

Alisa Vlasenko¹, Marcel Brosch¹, Frank W. Ohl¹, Michael T. Lippert¹

¹Leibniz Institute for Neurobiology, Systems Physiology of Learning, Brenneckestr.6, 39120 Magdeburg, Germany

Optogenetic brain stimulation is a potentially superior stimulation modality for neuroprostheses substituting lost senses. In contrast to electrical stimulation, optogenetic stimuli can be targeted to defined subsets of neurons instead of stimulating the whole tissue unselectively. However, the discovery of 'optoception' – unspecific perception of optogenetic stimulation in the brain even outside of sensory areas – raises the question, to what degree previously reported results from individual sensory areas are due to such generalized percepts. Here we compare naturalistic stimulation and optogenetic stimulation of the primary sensory neocortex in mice across different sensory modalities. First, we transduced mice with ChR2 in primary visual and somatosensory cortex. We then trained them in a head-fixed licking task to report the perception of natural or optogenetic stimuli. After initial learning of a first stimulation modality, a switch between sensory stimulation and optogenetic stimulation or between modalities occurred. We observed a sudden drop in performance for crossmodal shifts between V1 and S1, but not for intramodal shifts between optogenetic and sensory stimulation. This finding suggests an intrinsic perceptual coherence of intramodal stimulation and argues against the idea of an unspecific optogenetic percept explaining past results.

Prediction error drives olfactory learning and conditioned behavior in a spiking model of *Drosophila* larva

Anna-Maria Jürgensen¹, Panagiotis Sakagiannis¹, Michael Schleyer², Bertram Gerber^{3,4},
Martin Paul Nawrot¹

¹University of Cologne , Computational Systems Neuroscience , Zùlpicher Str 47b, 50674 Cologne , Germany

²Institute for the Advancement of Higher Education, Faculty of Science, Hokkaido University, Japan

³Leibniz Institute for Neurobiology (LIN), Department of Genetics, Magdeburg, Germany

⁴Institute for Biology, Otto-von-Guericke University, Magdeburg, Germany

Predicting positive or negative rewards from environmental clues is highly relevant to guide decision making and goal-directed behavior in vertebrates and invertebrates alike. In our model of the *Drosophila* larva mushroom body (MB) we test the capacity of prediction error coding to explain larval behavior in associative learning experiments. The theory of prediction error coding assumes that associative learning about stimulus A is proportional to the difference between the reinforcement currently received with A minus the reinforcement predicted by A, which is based on prior experience [1]. In our spiking model synapses between the MB intrinsic and output neurons are the site of plasticity. Modulation of synaptic strength during learning leads to an imbalance between MB outputs that represents the association of odors with rewards or punishments as a behavioral bias. We use replications of larval learning experiments on a realistic timescale to produce the time resolved dynamics of the behavioral bias and apply our locomotory model of the *Drosophila* larva to simulate movement towards or away from odor sources to replicate learning experiments [2]. We show that our implementation of prediction error can account for experimentally observed saturation of learning curves, extinction learning and the influence of reward and odor magnitude.

1. Rescorla, R.A. (1972). Informational variables in Pavlovian conditioning, in *Psychology of Learning and Motivation*, ed. G. H. Bower (New York, NY: Academic Press)
2. Weiglein, A., Gerstner, F., Mancini, N., Schleyer, M., & Gerber, B. (2019). One-trial learning in larval *Drosophila*. *Learning & Memory*, 26(4), 109-120.

ProBDNF Dependence of LTD in the Amygdala of Adult Mice

Susanne Meis¹, Xiaoyun Ma¹, Thomas Endres¹, Thomas Munsch¹, Volkmar Lessmann¹

¹Otto-von-Guericke University Magdeburg, Institute of Physiology, Leipzigerstr. 44, 39120 Magdeburg, Germany

Brain-derived neurotrophic factor (BDNF) is a critical regulator of differentiation, neuronal survival, and plasticity. While mature BDNF (mBDNF) regulates these functions via Trk tyrosine kinase signaling, the uncleaved pro-neurotrophin proBDNF interacts preferentially with the p75 neurotrophin receptor (p75NTR). Interestingly, mBDNF and proBDNF reportedly often exert antagonistic effects in the brain. In the amygdala, mBDNF enables long-term potentiation as well as fear learning. We therefore now focused on the impact of pro-BDNF signaling on long-term depression (LTD) in the lateral amygdala (LA).

Therefore, we conducted extracellular field potential recordings in an *in vitro* slice preparation and recorded LTD at the cortical and the thalamic input to the LA. LTD induced by paired pulse low-frequency stimulation (ppLFS, 1 Hz) for 15 min was NMDA receptor and calcineurin-dependent. LTD was unchanged by acute block of BDNF/TrkB signaling. In contrast, LTD was inhibited in slices obtained from p75NTR^{-/-} mice, by blocking p75NTR signaling, by disinhibition of the proteolytic cleavage of proBDNF into mature BDNF, and by preincubation with a function-blocking anti-proBDNF antibody. In addition, p75NTR signaling was also essential in ppLFS induced depotentiation after prior induction of LTP by high frequency stimulation (HFS).

Since reduction of excitatory synaptic strength in the LA seems to play a role in cued fear extinction learning, we also performed *ex vivo* recordings of LTD in acute slices of fear conditioned mice followed by extinction training, compared to LTD induced in fear conditioned mice which were exposed to the same context only. Importantly, LTD was significantly reduced in fear extinguished animals at both afferents to the LA. This occlusion of LTD by preceding extinction training is consistent with the hypothesis that extinction learning and LTD induced by our protocol share mutual cellular mechanisms at cortical as well as thalamic input synapses to the LA.

Overall, our results suggest that in the amygdala, proBDNF/p75NTR signaling plays a pivotal role in LTD as well as fear extinction learning (please see also poster of Endres et al. for more details on the action of proBDNF on fear extinction learning in the amygdala).

Supported by Deutsche Forschungsgemeinschaft (SFB 779, TP B6); EU Joint Programme - Neurodegenerative Disease Research (JPND) project CIRCROT (jointly funded by BMBF and European Union's Horizon 2020 research and innovation program (No 643417); the European Regional Development Fund (No. ZS/2016/04/78123) of initiative "Sachsen-Anhalt WISSENSCHAFT Schwerpunkte"; doctoral scholarship "Leistungsorientierten Mittelvergabe (LOM)" of the Medical Faculty Magdeburg.

Pro-BDNF signaling in the amygdala mediates fear extinction learning

Thomas Endres¹, Harish Vuyyuru¹, Susanne Meis¹, Volkmar Lessmann¹

¹Otto-von-Guericke University Magdeburg, Institute of Physiology, Leipzigerstr. 44, 39120 Magdeburg, Germany

A better understanding of the mechanisms underlying fear extinction learning might reveal new treatment approaches for several anxiety-disorders, as e.g. phobias. The neurotrophin BDNF (brain-derived neurotrophic factor) is an important mediator of both, synaptic plasticity and memory formation. While mature BDNF regulates these functions via TrkB signaling, the uncleaved precursor pro-BDNF preferentially binds to p75 neurotrophin receptors (p75NTR), exerting often opposite effects to those of BDNF/TrkB signaling. In a recent study we could identify that pro-BDNF regulates long-term depression (LTD) in the lateral amygdala (LA, please see poster of Meis et al.). Since fear extinction learning seems to be linked to depotentiation in the amygdala, we set up the hypothesis that fear extinction learning might be regulated by pro-BDNF/p75NTR-signaling in the LA. To this aim, we infused the p75NTR-antagonist TAT-Pep5 into the LA during or after fear extinction training. Here we observed that both, acquisition and consolidation of extinction memories were impaired after blocking p75NTR receptors in the LA. Thus, our experiments demonstrate for the first time that in the amygdala besides mature BDNF/TrkB also pro-BDNF/p75NTR signaling is an important mediator of fear extinction learning.

In another series of experiments, we then raised the question whether fear extinction learning could be improved by increasing the pro-BDNF availability in the amygdala. To this aim, we first developed a fear extinction paradigm that did not induce long-term fear extinction memories. To increase pro-BDNF in the amygdala, we locally infused α -2-antiplasmin to inhibit the cleavage of pro- to mature BDNF. When we performed this treatment before the insufficient extinction training, we observed successful fear extinction memory 24h later in these animals, while vehicle treated animals still exhibited high levels of conditioned fear. Thus, increasing the levels of pro-BDNF in the amygdala can improve fear extinction learning.

Overall, our data demonstrate an important role of pro-BDNF/p75NTR signaling in the amygdala for fear extinction learning, probably by initiating LTD-like mechanisms.

This work was supported by the DFG (SFB 779, TP B06).

Rab3 is required for olfactory learning

Aishwarya Aravamudhan¹, Divya Sachidanandan¹, Dennis Pauls¹, Stefan Hallermann²,
Robert J. Kittel¹

¹Department of Animal Physiology, Institute of Biology, Leipzig University, Leipzig, Germany

²Carl Ludwig Institute of Physiology, Leipzig University, Leipzig, Germany

Associative olfactory conditioning in *Drosophila* has been used to study learning and memory for over half a century. The mushroom body (MB) is the main learning centre in the *Drosophila* brain. It has been established that memory formation involves plastic changes at presynapses of Kenyon cells, the intrinsic MB neurons. Neurotransmitter release from the presynapse occurs at so-called active zones (AZs), highly specialized sub-cellular signaling compartments. However, the molecular mechanisms of AZ plasticity and how these mediate learning processes remain unknown. AZ function depends on the precise arrangement and the interactions of specific proteins, such as Bruchpilot (Brp), voltage-gated Ca²⁺ channels, the small GTPase Rab3, RIM (Rab3 interacting molecule), Unc13s, and RBP (RIM binding protein). Previous studies at the neuromuscular junction demonstrated that loss of Rab3 triggers a reorganization of Brp, leading to a decrease in total AZ number and an increase in individual AZ size. Moreover, our recent findings uncovered impaired cAMP-dependent presynaptic plasticity in *rab3* mutants (see poster by Sachidanandan et al). It is therefore of great interest to explore the behavioural consequences of these changes. By evaluating *rab3* null mutants and cell-specific knockout via CRISPR/Cas9, we show that Rab3 expression in a subset of Kenyon cells is necessary for aversive learning on a timescale of minutes. These findings provide a new entry point to improve our mechanistic understanding of the molecular processes that mediate memory formation.

Role of Nogo-A in regulating memory processes and memory engram formation by modulating neuronal excitability

Sebastian Stork¹, Jan Flechtner¹, Jennifer Just¹, Kristin Metzdorf^{1,2}, Steffen Fricke¹,
Martin Korte^{1,2}, Marta Zagrebelsky¹

¹TU Braunschweig, Zoological Institute, Spielmannstraße 7, 38106 Braunschweig, Germany

²Helmholtz Centre for Infection Research, AG NIND, Inhoffenstraße 7, D-38124 Braunschweig, Germany

Regulation of the excitation / inhibition balance (E/I balance) is essential for the proper development of the neuronal network as well as for synaptic plasticity in the adult brain, being the underlying mechanism for learning and memory events in the brain. These processes involve a myriad of molecules that enable the formation of an engram –a neuronal circuit that might be established between several brain regions and codes individual memory events - by allocating co-active neurons during learning processes based on their excitability levels. In this context, the E/I balance has been shown to be fine-tuned by the signalling of the myelin-associated neurite growth inhibitor Nogo-A via its receptors Nogo-66 receptor 1 (NgR1) and sphingosine 1-phosphate receptor 2 (S1PR2). Indeed, Nogo-A signalling restricts surface localization of α -amino-3-hydroxy-5-methyl-4-isoxazolepropionic acid receptor (AMPA), thus suppressing excitatory synaptic transmission. Moreover, signalling of Nogo-A via S1PR2 positively influences γ -aminobutyric acid receptor (GABA_AR) clustering in a Ca²⁺- and Calcineurin-dependent manner, thereby strengthening GABAergic inhibitory synaptic transmission. In addition, Nogo-A signalling promotes both activity-dependent synaptic plasticity as well as structural plasticity at a fast time scale resulting in improved spatial learning and memory retention. The above suggest a possible role of Nogo-A in modulating learning via the regulation of allocation of neurons to the memory engram by controlling their excitability. Here we address this hypothesis on both the cellular and the behavioural levels. In in-vitro Ca²⁺-imaging experiments, increased Ca²⁺-influx was observed when Nogo-A was blocked in resting primary hippocampal neurons and during chemical induction of LTP suggesting increased excitability due to Nogo-A loss-of-function. Moreover, improved spatial- and fear-learning and memory formation were observed in Nogo-A KO mice. Since Nogo-A is expressed in excitatory and inhibitory neurons, cell type-specific Nogo-A knockout mice for Parvalbumin(PV)-expressing interneurons and CamKIIa-expressing excitatory neurons were trained in the Morris water maze (MWM) for spatial learning. While deletion of Nogo-A in excitatory neurons shows a trend toward a faster learning, the PV-specific Nogo-A KO mice display an opposite effect. In a series of ongoing experiments the role of Nogo-A is addressed in regulating neuronal allocation in the hippocampus and amygdala upon spatial training in the MWM and contextual fear conditioning respectively. In this context, the correlation between learning performance and the engram formation induced by neuronal activation will be assessed through the expression of immediate early genes.

This work is supported by a grant of the DFG to Marta Zagrebelsky and Martin Korte

Serotonin antagonistically controls aversive and appetitive memory consolidation in flies

Lisa Scheunemann¹, Clément Hua³, Beatrice Kaiser¹, Anne Hoffmann¹, Olliver John¹,
Thomas Preat²

¹Freie Universität Berlin, Institut für Biologie, Takustraße 6, 14195 Berlin, Germany

²ESPCI Paris, Brain Plasticity Unit, CNRS, 10 rue Vauquelin, 75005 Paris, France

³Institut Curie, Molecular Oncology, CNRS, 26 rue d'Ulm, 75005 Paris, France

The ability to remember positive and negative experiences and adapt behavior accordingly allows animals to survive and thrive in challenging environments. In many species, dopamine transmits the valence of an experience, yet little is known about how gating mechanisms act to ensure that only relevant information is stored as a long-term memory (LTM). We have recently identified a molecular and cellular correlate of a gating mechanism in the *Drosophila* brain. Serotonergic projection neurons (SPNs) inhibit the formation of aversive LTM via the modulation of dopaminergic input to the mushroom body, the fly's memory center. Intriguingly, our data show that SPN activity increases aversive LTM while it decreases reward-driven, appetitive LTM. Such diametric effect on aversive and appetitive LTM is driven via excitatory and inhibitory serotonin receptors in the dopamine circuit. Our work shows how serotonin signals can antagonistically steer the memory circuit for the storage of rewarding or aversive experiences.

Silencing of HVC interneurons during playbacks alters adult zebra finch song

Fabian Heim^{1,2}, Ezequiel Mendoza³, Avani Koparkar^{2,4,5}, Constance Scharff³, Daniela Vallentin^{1,2}

¹Max-Planck-Institute for Biological Intelligence (in foundation), Seewiesen, Germany;

²Max-Planck-Institute for Ornithology, Seewiesen, Germany;

³Freie Universität Berlin, Berlin, Germany;

⁴Indian Institute of Science Education and Research (IISER), Pune, India;

⁵present address: Eberhard-Karls-Universität Tübingen, Germany

Juvenile male zebra finches learn their song from an adult tutor during a critical period. The song learning process is dynamic but leads to a static maintenance period in adulthood during which the song remains unchanged. In songbirds, the premotor nucleus HVC (proper name) functions as a key brain region to vocal learning and production. HVC receives auditory information and contributes to motor learning and output in both juveniles and adults. HVC is comprised of four different cell types including premotor neurons and GABAergic inhibitory interneurons which are involved in vocal production. GABAergic interneurons in HVC of juvenile males selectively inhibit premotor neurons while birds listen to learnt but not unfamiliar song elements. This suggests that inhibitory interneurons in HVC provide a mechanism which protects learnt song in adult zebra finches from auditory induced plasticity which occurs during the learning phase. To validate the hypothesis that HVC interneurons are crucial for song stability in adulthood we sought to remove inhibitory control with pharmacological and optogenetic approaches.

First, we administered a GABA-A antagonist on HVC during playbacks of birds own song (BOS) with an altered syllable sequence while simultaneously monitoring the birds' song production. Lifting the impact of inhibition in HVC resulted in the occurrence of novel elements as well as sequence changes during song production throughout the experiment. These changes occurred temporarily and reverted back to normal after the pharmacological agent's washout period.

Next, we designed a viral strategy to optogenetically suppress GABAergic interneuron activity in freely moving adult zebra finches. We then hyperpolarised inhibitory interneurons while the birds were listening to novel song playbacks. This resulted in the addition of novel elements towards the end of the birds' otherwise unchanged song which persisted beyond the stimulation phase. Zebra finches which received the same treatment after they had been injected with a control virus did not display changes in their singing behaviour.

Our results imply that GABAergic inhibitory interneurons in HVC are crucial for the performance stability of learnt song production in adult zebra finches. Moreover, precise and cell-type specific manipulations of the inhibitory network in HVC have the potential to re-open the song learning phase, and enable adult zebra finches to learn novel song elements after their critical period.

Social feedback shapes behavioral strategies for courtship in *Drosophila*

Frederic Alexander Römschied^{1,2}, Elise C Ireland¹, Adam J Calhoun^{1,3}, Minseung S Choi^{1,4}, Osama Ahmed^{1,5}, Mala Murthy¹

¹Princeton Neuroscience Institute, Washington Rd, Princeton, NJ 08544, USA

²Universität Göttingen, European Neuroscience Institute, Grisebachstr. 5, 37077 Göttingen, Germany

³Meta Reality Labs, New York, NY, USA

⁴Stanford University School of Medicine, Stanford, CA, USA

⁵Department of Psychology, University of Washington, Seattle, WA, USA

Social feedback (i.e., feedback from social peers in response to one's own actions) can have strong and long-lasting effects on behavior. For example, embarrassing a communication partner by unintentionally using an offensive phrase can trigger suppression to use that phrase for many years. Such learning from social feedback allows one to adjust to new social contexts or rules, and ultimately facilitates success in social environments. Despite the generality of social feedback learning across species, its neural and molecular basis is currently unknown in any system. This is likely due to the lack of A), suitable model systems, and B), a general framework to measure behavioral strategies and their dependence on social experience. Here we aim at closing both gaps: we first introduce a Bayesian framework that quantitates social experience and behavioral strategies by decomposing data from automated pose estimation in freely behaving animals into a set of base experiences and base strategies. We then apply this framework to show that the innate courtship strategy of male *Drosophila* is shaped by past social experience.

During courtship, the male fly follows the female and uses acoustic signals generated by vibrations of a single wing ('song') to advertise himself to the female. The female provides social feedback to the male, e.g. by slowing down to facilitate copulation, or extruding her ovipositor to signal rejection. The male in turn uses these feedback cues to update his subsequent courtship behavior on a moment-to-moment basis. While a growing body of work has started to identify and characterize the neural circuits driving male courtship behavior and its flexibility at fast timescales, it is unknown whether the innate courtship strategy of the male can be adjusted in response to novel social experience, at the longer timescales of learning. We therefore developed a novel assay for social feedback learning, comprising two experiments: in a first training experiment, we used closed-loop optogenetics to control the female's feedback to male song, to systematically perturb the male's social experience around the time of his own song. In a subsequent test experiment, we used our Bayesian framework to evaluate the trained male's song strategy towards a female providing normal feedback. Compared to controls, males that had experienced perturbed social feedback during training used distinct song strategies during the test experiment, suggesting that the innate courtship strategy is flexible and can be shaped through learning from social feedback.

We corroborated this result by showing that known learning mutants (*dnc1* but not *rut1*), as well as males with genetically downregulated dopamine receptor expression (Dop1R1, but not Dop2R) are also deficient in social feedback learning. Together, these results demonstrate a surprising flexibility of innate social behavior in flies, and they open the door for a circuit-level understanding of social feedback learning in this powerful genetic model system, *Drosophila*. Further, our Bayesian framework is generally applicable in any system, to quantitate behavioral strategies and their dependence on social experience.

This work was supported by the German Research Foundation (DFG RO 5787/1-1).

Synaptic structural homeostatic mechanisms in the hippocampal CA1 region of live mice

Bhargavi Murthy¹, Hannah Klimmt¹, Inna Slutsky², Alessio Attardo¹

¹Department of Cellular Neuroscience, Leibniz Institute for Neurobiology, 39118 Magdeburg, Germany

²Tel Aviv University, Tel Aviv 69978, Israel

Experience induces specific neural activity patterns and plasticity of synaptic connections, thus enabling information storage. But in the face of constant environmental change and plasticity mechanisms, homeostatic compensation at the synaptic level ensures stability by diverse functional and structural modifications such as, change in dendritic spine density and size –as demonstrated in cortical brain regions. Little is known, however, on how homeostatic compensation affects spatial patterns of excitatory synapses in the hippocampus. The aim of this project is to understand how homeostatic rules operate in the hippocampus in vivo. Specifically, this project will investigate if changes in the stability and density of excitatory synapses constitute adaptive mechanisms in response to perturbed neuronal activity. By employing deep-brain 2-photon imaging in live mice, we will chronically track and measure the synaptic dynamics of excitatory neurons in the CA1 region, in response to chemogenetically manipulated neuronal activity. Through this project, we will also be able to recognize the timescale required for synaptic structural homeostatic mechanisms to emerge in the hippocampus. The study results can potentially contribute to bridging the gap between the properties of individual neurons and the emerging properties of neuronal populations, and lead to a deeper understanding of how neural circuits maintain functional stability upon perturbation of activity.

The cellular architecture of memory modules in *Drosophila* supports stochastic input integration

Rouven Ziegler¹, Omar A. Hafez^{2,3}, Benjamin Escribano¹, Jan J. Hirtz⁵, Ernst Niebur^{2,4},
Jan Pielage¹

¹Division of Neurobiology and Zoology, Department of Biology, University of Kaiserslautern, D-67663 Kaiserslautern, Germany

²Zanvyl Krieger Mind/Brain Institute, Johns Hopkins University, Baltimore, MD 21218, USA

³Yale MD-PhD Program, Yale School of Medicine, New Haven, CT 06510, USA

⁴Solomon Snyder Department of Neuroscience, Johns Hopkins University School of Medicine, Baltimore MD 21218, USA

⁵Physiology of Neuronal Networks Group, Department of Biology, University of Kaiserslautern, D-67663 Kaiserslautern, Germany

The ability to associate neutral stimuli with valence information and to store these associations as memories forms the basis for decision making. To determine the underlying computational principles, we build realistic computational models of individual central decision modules within the *Drosophila* mushroom body (MB), the fly's center for learning and memory. Our current model combines the electron microscopy-based architecture of one MB output neuron (MBON- α 3), the synaptic connectivity of its 948 presynaptic Kenyon cells (KCs), and its *in vivo* membrane properties obtained from patch-clamp recordings. We show that this neuron is electrotonically compact and that synaptic input corresponding to simulated odor input robustly drives its spiking behavior. Therefore, sparse innervation by KCs can efficiently control and modulate MBON activity in response to learning with minimal requirements on the specificity of synaptic localization. This architecture allows efficient storage of large numbers of memories using the flexible stochastic connectivity of the circuit. To further elucidate how the network activity of MBONs can be dynamically shaped to incorporate multiple parallel memories, we are currently expanding our model to several MBONs and integrating additional experimental data.

The virtual magnetic environment: Towards a fast and robust behavioural assay to study magnetoreception in subterranean mole-rats

Georgina Fenton¹, Brittany Hamauei¹, Pascal Malkemper¹

¹Max Planck Institute for Neurobiology and Behaviour – caesar, Department of Neurobiology of Magnetoreception, Ludwig-Erhard-Allee 2, 53175 Bonn, Germany

Multiple subterranean mammals possess a magnetic sense, but the principal function of this sense is yet to be elucidated. Much of our knowledge is obtained from the Ansell's mole-rat, *Fukomys anselli*, who build nests in the magnetic South-East region of an open field arena. The nest-building assay, due to its reliability, has become the standard paradigm to study magnetoreception in rodents. However, this assay has a major limitation - it is time consuming. This makes data collection inefficient and renders it unusable in the study of acute behaviours.

We, therefore, went on a hunt for a fast, simple and replicable behavioural assay to demonstrate the perception of magnetic fields. We hypothesised that mole-rats primarily use their magnetic sense during exploration, i.e. tunnelling, but may also be able to use it during conditioned behaviours given the right spatial context. Here, we present the efficacy of both explorative (e.g. novel magnetic object, maze navigation) and associative learning (e.g. T-maze, radial arm maze) paradigms. Using automated closed-loops between live animal tracking and a magnetic coil system we created a virtual magnetic environment that responds to the position of the animal. This enabled us to conveniently test multiple behavioural paradigms within the same coil setup, under controlled conditions. We provide a comprehensive analysis of the efficiency of different behavioural paradigms for characterising the magnetic sense in Ansell's mole-rats.

Toxic effects of neonicotinoids on memory and brain morphology: the fruit fly *Drosophila melanogaster* as a study case.

Annekathrin Widmann¹, Julia Schulz²

¹University of Göttingen, Molecular Neurobiology of Behaviour, Julia-Lermontowa-Weg, 37085 Göttingen, Germany¹

²University of Kaiserslautern, Kaiserslautern, Germany²

Despite the well-documented effects on the global decline in the abundance and diversity of many beneficial species, the worldwide insecticide consumption is steadily increasing. In particular, neonicotinoid insecticides have become the fastest growing class of insecticides in recent decades. The toxicity of these insecticides relies on their interference with the cholinergic neurotransmission by interacting with the extracellular domain of the postsynaptic nicotinic acetylcholine receptor and their mode of action is strongly related to concentration and exposure times. For example, field-realistic doses have sub-lethal effects on beneficial insects and can disrupt behaviors like learning and memory, locomotion, foraging success, circadian rhythms and sleep in honeybees and bumblebees.

Compared to honeybees the fruit fly *Drosophila melanogaster* offers the unique perspective of having a less complex brain in terms of number of neurons, but nevertheless a wide range of different behaviors. Furthermore, the circuitry and molecular compounds of the mushroom body – a high-order sensory integration, learning and memory centre – are shown to be highly conserved across invertebrates. Together with the sophisticated genetic toolkits and the reconstruction of every single neuron with all its synapses and synaptic partners, the fruit fly represents the ideal model organism to analyse the effects of different sublethal concentrations and exposure times of neonicotinoids on various behavioural and morphological toxicity biomarkers. To additionally address possible developmental interferences animals were exposed at different developmental stages. Because of the postulated interference of the insecticide with the cholinergic system, our study focused on evaluating potential effects subject to cholinergic regulation using the neonicotinoid imidacloprid.

Indeed, our results confirmed a significant impairment of behaviours related to cholinergic signalling, depending on the concentration and incubation time of neonicotinoid, but also on the developmental stage of the animal. Firstly, we were able to show that significant effects on short-term memory is only manifested in response to imidacloprid treatment in the adult but not larval stage and the effects are more prone to higher imidacloprid concentration. Contrary, a significant effect on long-term memory was visible after imidacloprid treatment in the larval as well as in the adult state and this effect was independent of the concentration. Based on these results, it can be concluded that animals treated in the adult stage show a higher sensitivity to imidacloprid exposure than flies exposed as larvae. This may be due to a developmental advantage of the larval stage, possibly resulting from neuronal reorganisation during metamorphosis. In addition, our data suggest that long-term memory is more exposed to imidacloprid treatment than short-term memory. Since a memory persisting over several days, in contrast to a form of memory limited to a few hours, is based on a repetitive stimulation of the synapse and an accompanying strong Ca^{2+} influx in the context of long-term potentiation, it can be assumed that long-term memory reacts more sensitively to a desensitisation of postsynaptic acetylcholine receptors than short-term memory. Secondly, evidence for this assumption was provided by our experiments in a connectivity study between cholinergic input neurons and the mushroom body. This study confirmed a significant treatment effect the longer the animals were exposed to the insecticide. Thirdly, regarding the effect on circadian activity, a significant increase in the difference between

diurnal and nocturnal activity could be verified regardless of the duration of exposure to imidacloprid. Therefore, it can be assumed that not only a defective circuit in the mushroom body is responsible for the strong effect in the formation of a long-term memory, but that also that less energy is available for ATP-dependent protein synthesis in the context of long-term memory formation due to a reduced energy consumption resulting from an increased diurnal activity of the animals due to neonicotinoid exposure.

Understanding rat behavior in a complex task via non-deterministic policies

Johannes Niediek¹, Maciej M. Jankowski¹, Ana Polterovich¹, Alexander Kazakov¹, Israel Nelken^{1,2}

¹The Hebrew University of Jerusalem, The Edmond and Lily Safra Center for Brain Sciences, Edmond J. Safra Campus, 9190401 Jerusalem, Israel

²The Hebrew University of Jerusalem, The Alexander Silberman Institute of Life Sciences, Edmond J. Safra Campus, 9190401 Jerusalem, Israel

Animal experiments in neuroscience often use simple, coarse measures of behavior. For example, trial outcome (correct/incorrect) is sometimes the only behavioral variable considered. However, this does not capture the complexity of animal behavior, with trials consisting of many animal actions. We developed a framework to study the behavior and simultaneous neuronal activity of freely moving rats at high spatial and temporal resolution. We model behavioral tasks as Markov Decision Processes (MDPs), where a rat trajectory is described as a sequence of well-defined environment states and rat actions, with state transitions depending on current state and action. We computed deterministic optimal policies (a policy is a rule that prescribes an action in each state). However, rat behavior was not deterministic. We thus also computed non-deterministic, information-limited policies that realize optimal reward rates at a prescribed amount of deviation from non-informative behavior, quantified as the Kullback-Leibler divergence from a default, non-informative policy (Tishby's complexity, TC).

We applied our framework to data from five female rats performing a complex auditory-guided task, implemented in a large environment (diameter 160 cm) equipped with twelve nose-poke ports and loudspeakers to convey information to the rats. Rats had to position themselves at specific locations indicated by sounds to obtain reward. Despite the nontrivial task, rats reached high success rates within two 70-minute sessions. Observed rat trajectories resembled optimal policies derived from the model, but were non-deterministic. We estimated the TC of rat movement and nose-poking and its change over time by comparing rat behavior with information-limited policies.

Our model revealed a prolonged, large increase in the TC over time. Significantly, this prolonged behavioral refinement was not discernible via reward rates, and to our knowledge has not been described previously. The model also captured individual propensities for preferring some foraging strategies over others, as well as a reduction in the tendency of rats to perform nose-pokes that do not result in reward.

Recording with chronically implanted silicon probes from the left insular cortex, we found that in many neurons, firing rates (averaged over ten minutes) strongly correlated with TC in the same time periods. The proportion of highly correlated units was significantly larger in real recordings than in surrogate data.

Our model is based on first principles of information theory rather than on ad-hoc measures of behavior. Measures derived from this model bring new insights into rat behavior, and seem to be reflected in rat brain activity.

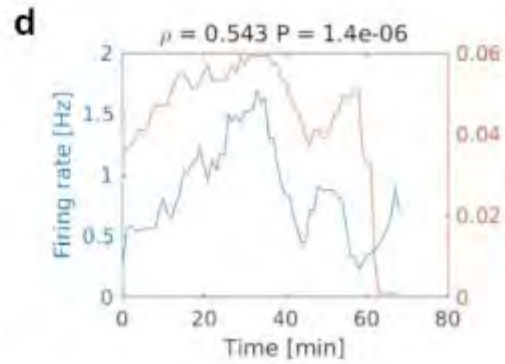
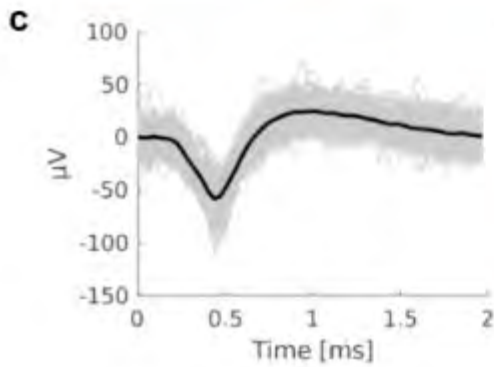
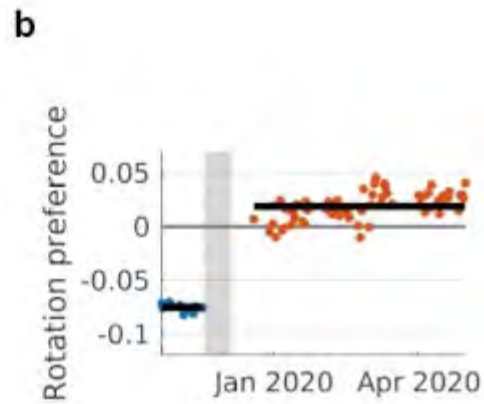

a) a large behavioral arena with twelve loudspeakers and twelve food/water ports was used to train five female rats in a complex, auditory-guided task. b) Our reinforcement-learning model captured a rat's propensity to rotate its body, and the rat's change in preference upon task modification. c) Recording from the left insular cortex during task performance. d) Optimal task policies were parametrized by β . A rat's β was estimated in 10-min time-windows. Average firing rates during these windows correlated with β .

Poster Topic

T26: Computational Neuroscience

- [T26-1A](#) A Comprehensive deep learning model for Object and Spatial representations in Hippocampal formation
Azra Aziz, Bharat Kailas Patil, V Srinivasa Chakravarthy
- [T26-2A](#) A computational model of olfactory processing in the fly antennal lobe using EM data.
Magdalena Anna Springer, Lydia Gruber, Jürgen Rybak, Bill S. Hansson, Martin P. Nawrot
- [T26-3A](#) Assessing behavioural Symptomology in *Drosophila melanogaster*
Hannah Jones, Giorgio Gilestro, Jenny Willis, Rob Lind
- [T26-4A](#) Big Data in microscopy – an AI-assisted biosensor analyses approach
Anna Kling, Franziska Müller, Evgeni Ponimaskin, Andre Zeug, Alexander Wirth
- [T26-5A](#) Computational modelling of neuron-astrocyte interactions in the NEST simulator
Han-Jia Jiang, Jugoslava Acimovic, Tiina Manninen, Jonas Stapmanns, Mikko Lehtimäki, Marja-Leena Linne, Markus Diesmann, Sacha J. van Albada
- [T26-6A](#) Data-driven method to generate single neuron models from spike trains of sensory neurons
Ibrahim Alperen Tunc, Svenja Corneliussen, Jan Radermacher, Peter Kloppenburg, Martin Paul Nawrot
- [T26-7A](#) Deep learning based 3D-segmentation of dendritic spines recorded with two-photon in vivo imaging
Fabrizio Musacchio, Pragya Mishra, Pranjal Dhole, Shekoufeh Gorgi Zadeh, Sophie Crux, Felix Nebeling, Stefanie Poll, Manuel Mittag, Falko Fuhrmann, Eleonora Ambrad, Andrea Baral, Julia Steffen, Miguel Fernandes, Thomas Schultz, Martin Fuhrmann
- [T26-1B](#) Developmental speed and network stability advantages may favour an ordered organisation of cortical stimulus preference in primates and carnivores
Zoe Rowe Stawyskyj, Michael Sternbach, Fred Wolf
- [T26-2B](#) Dynamic Gain Analysis of Axon Initial Segment Function in High-Bandwidth Population Encoding
Neil Lewis Wesch, Elinor Lazarov, Chenfei Zhang, Fred Wolf, Andreas Neef
- [T26-3B](#) Efficient control of oscillations and synchrony in computational models of neural dynamics
Lena Salfenmoser, Klaus Obermayer

- [T26-4B](#) Identification and Removal of Artifacts in Massively Parallel Recordings
Jonas Oberste-Frielinghaus, Simon Essink, Alexander Kleinjohann, Julia Sprenger, Junji Ito, Sonja Grün
- [T26-5B](#) Mesoscopic modelling of large-scale networks of leaky integrate-and-fire neurons
Jan-Eirik Welle Skaar, Hans E. Plesser, Gaute T. Einevoll, Kristin Tøndel
- [T26-6B](#) Modeling the electrosensory periphery of *Eigenmannia virescens*
Sarah Mayer, Jan Benda, Jan Grewe
- [T26-7B](#) NEST-SONATA: Fast parallel instantiation of explicitly specified large-scale neuronal network models
Hans Ekkehard Plesser, Nicolai Haug, Håkon Bakke Mørk, Stine Brekke Vennemo, Susanne Kunkel, Kael Dai, Anton Arkhipov
- [T26-1C](#) Neural dynamics underlying human vocalization
Vera A. Voigtländer, Florian Sandhaeger, Dawid J. Hawellek, Steffen R. Hage, Markus Siegel
- [T26-2C](#) Non-Stationary recurrent neural networks for reconstructing computational dynamics of rule learning
Max Ingo Thurm, Georgia Koppe, Eleonora Russo, Florian Bähner, Daniel Durstewitz
- [T26-3C](#) Physiologically-inspired neurodynamical model for anorthoscopic perception
Martin A. Giese, Anna Bognar, Rufin Vogels
- [T26-4C](#) Rats adapt optimally to changes in reinforcement probabilities, stimulus presentation probabilities and discrimination difficulty in a perceptual decision making task
Luis de la Cuesta Ferrer, Christina Koß, Andrea Dietl, Frank Jäkel, Maik C. Stüttgen
- [T26-5C](#) Relating the orientation of cortical traveling waves and co-occurring spike patterns
Sven Krauß, Robin Gutzen, Alessandra Stella, Thomas Brochier, Alexa Riehle, Sonja Grün, Michael Denker
- [T26-6C](#) Robustness of a self-regulating neuronal network model in response to mutated ion channels
Philippa Hennessey, Jan Benda, Lukas Sonnenberg
- [T26-7C](#) Spontaneous Initiation of Spreading Depression in a Heterogeneous Network
Allison Harris, Wolfgang Stein

A Comprehensive deep learning model for Object and Spatial representations in Hippocampal formation

Azra Aziz¹, Bharat Kailas Patil¹, V Srinivasa Chakravarthy^{1,2}

¹Indian Institute of Technology Madras, Biotechnology, IIT Madras Post office, 600036 Chennai, India

²Indian Institute of Technology Madras, Center for Complex Systems and Dynamics, IIT Madras Post office, 600036, Chennai, India

Navigation is a vital skill for the survival of animals. Over the past several decades, evidence has been accumulated to show that hippocampus constructs a spatial cognitive map of the ambient space. Since the discovery of several classes of hippocampal spatial cells like the place cells (O'Keefe & Dostrovsky, 1971), head direction (HD) cells (Taube et al., 1990), and grid cells (Hafting et al., 2005), the role of sensory information other than locomotion in shaping the responses of the spatial cells has become an area of interest for experimental research. It is evident that the Medial Entorhinal Cortex (MEC) predominantly processes information from locomotion for path integration (PI) hypothesized as 'where' pathway. In comparison, the discovery of object-responsive neurons in the Lateral Entorhinal Cortex (LEC) (Deshmukh & Knierim, 2011; Tsao et al., 2013) gave a hint of visual information processing hypothesized as 'what' pathway. LEC and MEC then project to the Hippocampus proper, and neurons responding to objects/cues/landmarks in various settings are observed in various regions. e.g., place cell firing fields are influenced by the rotation of the cue in the environment (Geva-Sagiv et al., 2016). Neuron firing fields that maintain the vector relationship with multiple objects called Landmark vector cells (Deshmukh & Knierim, 2013) are observed in CA1. A small set of neurons showed memory for the object's previous location in the CA1, CA3 and LEC regions of the hippocampal formation (Deshmukh & Knierim, 2013; Tsao et al., 2013). Although distal object responsive neurons called object-vector cells (OVC) in MEC are also observed that fire at a particular distance and direction from an object as there are feedback connections from the Hippocampus proper to MEC (Høydal et al., 2019). Therefore, "what" and "where" pathways primarily depend upon the context of navigation and are not clearly distinguished (Save & Sargolini, 2017).

A wide variety of models are proposed for grid cells and place cells based on PI, since PI is enough to produce these kinds of neural responses (Burak & Fiete, 2009; Burgess et al., 2007; Bush & Burgess, 2014), but there are no models for the neurons that can replicate the neural responses based on objects and landmarks that performs multi-sensory integration. In order to model such neurons, nonlinear processing of sensory information is required. Therefore, we propose a comprehensive deep network trained on reward scheme that combines realistic visual inputs, obtained from an environment simulated in Virtual reality (VR), with PI to model a wide variety of neurons that respond to objects and landmarks in different ways, along with grid cells and place cells. The network contains two parallel pipelines: 1) Vision pipeline: Convolution layers to process visual inputs, 2) PI pipeline: This pipeline takes Head Direction as the input to the PI layer adapted from (Aziz et al., 2022). The output of the PI layer is further passed through fully connected layers. The vision and PI pipelines are laterally connected through the Graph Neural Network (GNN) layer. The network further contains three long short-term memory (LSTM) layers for modeling memory responsive neurons found in LEC, CA1 and CA3 (Fig 1).

Drawing a comparison with the previous models of spatial representation, this model paves way for a simplified and synthetic modelling approach that combine object- and spatial-selectivity in hippocampus.

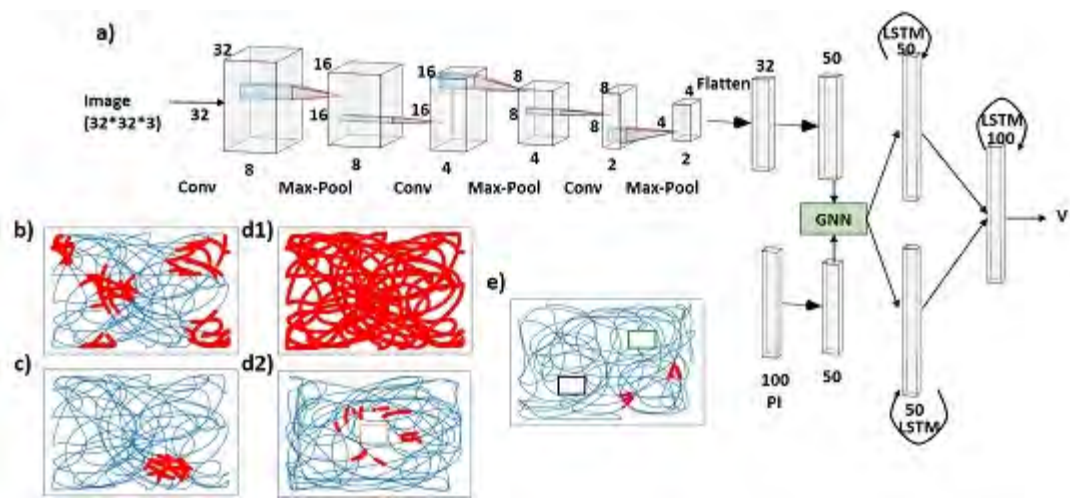

Fig 1: a) Model architecture with two pipelines i.e., vision and PI. b) Grid cell response. c) Place cell response. d1) Object Cells: No spatial selectivity of neuron firing when object is absent in the environment and d2) Spatial selectivity of neuron as soon as object is introduced in the environment. e) Landmark vector cells: Neurons firing fields maintains the vectorial relationship with multiple objects in the environment.

A computational model of olfactory processing in the fly antennal lobe using EM data.

Magdalena Anna Springer¹, Lydia Gruber², Jürgen Rybak², Bill S. Hansson², Martin P. Nawrot¹

¹Computational Systems Neuroscience, Institute of Zoology, University of Cologne, Cologne, Germany

²Department of Evolutionary Neuroethology, Max Planck Institute for Chemical Ecology (MPG), Jena, Germany

Within the last years, a variety of breakthrough connectomic studies investigating the fly olfactory system have provided insight into the specific wiring within its neuronal core structures [1,2]. These comprehensive data sets provide new possibilities to investigate the functional implications of the specific characteristics of neuronal circuits [3,4]. In this project, we make use of recent electron microscopic data by building a compartmentalized spiking model of a single densely packed glomerulus within the fly antennal lobe. Based on the detailed reconstruction of the wiring pattern within this glomerulus, we study functional aspects of the dense local connectivity and the polyadic structure. We further propose a functional role of autaptic dendro-dendritic connections in the uniglomerular projection neuron. The model shows how the specific neuronal wiring within this miniaturized neuronal core circuit can promote reliable burst responses indicating optimization of sensory processing in a natural odor environment.

[1] Rybak et al. (2016), *J Comp Neurol*, 524(9):1920-1956

[2] Scheffer et al. (2020), *eLife*, 9:e57443

[3] Tobin et al. (2017), *eLife*, 6:e24838

[4] Liu et al. (2022), *Current Biology*, 32(3):559–569

Assessing behavioural Symptomology in *Drosophila melanogaster*

Hannah Jones^{1,2}, Giorgio Gilestro², Jenny Willis³, Rob Lind³

¹University of Oxford, Department of Biology, Mansfield Road, OX1 3SZ Oxford, United Kingdom

²Imperial College London, South Kensington, SW7 2AZ, London, United Kingdom

³Syngenta, Jealott's Hill International Research Centre, RG42 6EY, Bracknell, United Kingdom

Identifying insect responses to different novel pesticides is often necessary to understand both mode of action and possible responses in the field. However, it is often difficult to do this in a high-throughput manner and quantitatively.

For this purpose, we used a novel activity monitoring system to record the behavioural responses of *Drosophila melanogaster* when exposed to different insecticide compounds. We then used both a statistical classification technique and behavioural analysis to classify these compounds based on their mode of action and symptomology.

Results from this work have demonstrated that exposure of flies to various compounds leads to unique and identifiable sub-lethal behavioural responses. This work demonstrates that an image analysis pipeline can be used to quantify complex behaviours arising from insecticide exposure.

Big Data in microscopy – an AI-assisted biosensor analyses approach

Anna Kling¹, Franziska Müller¹, Evgeni Ponimaskin¹, Andre Zeug¹, Alexander Wirth¹

¹Medical School Hannover, Cellular Neurophysiology, Carl-Neuberg-Straße 1, 30625 Hannover, Germany

Quantitative analysis of bio-imaging datasets from fluorescence and confocal microscopy becomes more and more relevant in modern neuroscience. At the same time, recent developments in advanced imaging techniques is connected with recordings of large amount of data that need to be handled and properly analysed. So far, image processing is often linked to a time and resource-consuming work of annotation and evaluation. To overcome this problem, deep learning algorithms and artificial intelligence (AI) have found their way into the evaluation of microscopy data.

Here, we present a workflow for big imaging data analysis, including 3D data acquisition, an AI-assisted segmentation algorithm as well as GPU-based batch analysis at a high-performance computing cluster. This approach was developed to study spatiotemporal mTOR signalling in acute brain slices with the single-neuron resolution. To this end, we used two-photon excitation microscopy in combination with application of the FRET-based biosensor TORCAR, which allows to monitor the activity of the mTOR kinase. Imaging data were subjected to automated denoising and AI-based ROI detection of cell somata followed by pixel-based analysis of the FRET ratio.

The automated workflow represents not only an unbiased analysis of segmentation and specific region detection, but also renders the data analysis less time consuming from pre-processing, analysis and final quantification of big data in microscopy. Most importantly, the presented approach can be easily adapted to other biosensor and indicator applications.

Computational modelling of neuron-astrocyte interactions in the NEST simulator

Han-Jia Jiang^{1,5}, Jugoslava Acimovic², Tiina Manninen², Jonas Stapmanns^{1,3}, Mikko Lehtimäki², Marja-Leena Linne², Markus Diesmann^{1,3,4}, Sacha J. van Albada^{1,5}

¹Institute of Neuroscience and Medicine (INM-6) and Institute for Advanced Simulation (IAS-6) and JARA-Institute Brain Structure-Function Relationships (INM-10), Jülich Research Centre, Jülich, Germany

²Faculty of Medicine and Health Technology, Computational Neuroscience, Tampere University, Tampere, Finland

³Department of Psychiatry, Psychotherapy and Psychosomatics, School of Medicine, RWTH Aachen University, Aachen, Germany

⁴Department of Physics, Faculty 1, RWTH Aachen University, Aachen, Germany

⁵Institute of Zoology, Faculty of Mathematics and Natural Sciences, University of Cologne, Cologne, Germany

Astrocytes in the cerebral cortex interact with neurons and synapses through complex cellular mechanisms [1]. A single astrocyte microdomain can contact several hundreds of neurons and tens (possibly even hundreds) of thousands of synapses [2], where astrocytic processes interact with synaptic transmission and plasticity and affect neuronal excitability [1, 3]. Experimental studies have also shown coordinated neuronal and astrocytic activity in vivo and an active role of astrocytes in brain functions [1, 4]. Computational methods for the neuron-astrocyte interactions can help to explore their roles at cellular to whole-brain levels to study relevant functions and dysfunctions.

In recent years, hundreds of computational models involving neuron-astrocyte interactions have been published [5, 6]. However, the code of these published models is often not publicly available. Only a few tools are open-source, including Arachne [7] and an implementation in the Brian simulator [8], thereby improving the reproducibility of the modeling of neuron-astrocyte interactions.

As a new open-source contribution, we developed a module for neuron-astrocyte interactions in the NEST simulator [9]. This includes an astrocyte model in which astrocytic calcium dynamics is implemented, and a synapse model for astrocyte-neuron signaling through the generation of slow inward current in postsynaptic neurons. Furthermore, a user-friendly connection builder function is supplied, which efficiently handles the high-level neuron-astrocyte connectivity, providing probabilistic or partially deterministic neuron-astrocyte pairing. This new module allows one to create large and heterogeneous populations of interacting neurons and astrocytes. We tested this new tool by analyzing spontaneous firing activity of the neurons in medium-size networks of several hundreds of cells, showing the effects of different levels and types of connectivity on neuron excitability.

In summary, our new astrocyte module in NEST will support reproducible, open-access and efficient development of large-scale models of neuron-astrocyte interactions, and improve the convenience and reliability of computational studies of astrocytic functions in the brain.

References

- [1] Bazargani, N., & Attwell, D. (2016). Astrocyte calcium signaling: the third wave. *Nature Neuroscience*, 19(2), 182-189.
- [2] Zisis, E., Keller, D., Kanari, L., Arnaudon, A., Gevaert, M., Delemontex, T., ... & Markram, H. (2021).

Digital reconstruction of the neuro-glia-vascular architecture. *Cerebral Cortex*, 31(12), 5686-5703.

[3] Linne, M. L., Acimovic, J., Saudargiene, A., & Manninen, T. (2022). Neuron–Glia Interactions and Brain Circuits. In *Computational Modelling of the Brain* (pp. 87-103). Springer, Cham.

[4] Lines, J., Martin, E. D., Kofuji, P., Aguilar, J., & Araque, A. (2020). Astrocytes modulate sensory-evoked neuronal network activity. *Nature Communications*, 11(1), 1-12.

[5] Manninen, T., Havela, R., & Linne, M. L. (2018). Computational models for calcium-mediated astrocyte functions. *Frontiers in Computational Neuroscience*, 12, 14.

[6] Manninen, T., Acimovic, J., Havela, R., Teppola, H., & Linne, M. L. (2018). Challenges in reproducibility, replicability, and comparability of computational models and tools for neuronal and glial networks, cells, and subcellular structures. *Frontiers in Neuroinformatics*, 12, 20.

[7] Aleksin, S. G., Zheng, K., Rusakov, D. A., & Savtchenko, L. P. (2017). ARACHNE: a neural-neuroglial network builder with remotely controlled parallel computing. *PLoS Computational Biology*, 13(3), e1005467.

[8] Stimberg M, et al. (2019) In *Computational Glioscience*, eds. De Pittà and H. Berry, 471-505- Cham, Switzerland: Springer. [Doi.org/10.1007/978-3-030-00817-8_18](https://doi.org/10.1007/978-3-030-00817-8_18)

[9] Spreizer, Sebastian, Mitchell, Jessica, Jordan, Jakob, Wybo, Willem, Kurth, Anno, Vennemo, Stine Brekke, Pronold, Jari, Trensche, Guido, Benelhedi, Mohamed Ayssar, Terhorst, Dennis, Eppler, Jochen Martin, Mørk, Håkon, Linssen, Charl, Senk, Johanna, Lober, Melissa, Morrison, Abigail, Graber, Steffen, Kunkel, Susanne, Gutzen, Robin, & Plesser, Hans Ekkehard. (2022). NEST 3.3 (3.2). Zenodo. <https://doi.org/10.5281/zenodo.6368024>

Data-driven method to generate single neuron models from spike trains of sensory neurons

Ibrahim Alperen Tunc¹, Svenja Corneliussen², Jan Radermacher², Peter Kloppenburg²,
Martin Paul Nawrot¹

¹Institute of Zoology, University of Cologne, Computational Systems Neuroscience, Zùlpicherstr. 47B, 50674 Cologne, Germany

²Institute of Zoology, University of Cologne, Faculty of Math. Nat. Sciences, Zùlpicherstr. 47B, 50674 Cologne, Germany

Early components of sensory systems face the challenge of transforming relevant sensory stimuli into a neuronal code, which should be decodable by the respective downstream targets to induce and orchestrate further behavior. One common coding mechanism across diverse sensory modalities is the rate code, where specific stimulus aspects (such as concentration, temperature, intensity, orientation, spatial frequency etc.) are mapped to the firing rate of the sensory neurons. The stimulus-response relationship of rate coding sensory neurons can be described by transfer functions, which outline the expected neuronal firing rate as a function of the stimulus. In this study, we propose data-driven data analysis pipeline to extract relevant parameters from spike trains of neurons during sensory stimulation to generate single-neuron models of different complexities. The first step is to calculate transfer functions, where we compare three different approaches of firing rate estimation. In the first two approaches the instantaneous firing rate is calculated either by convolution, or by taking the inverse of the interspike interval. In the last approach, a stimulus histogram is used to normalize the spike count in each stimulus bin to estimate the firing rate. The resulting transfer functions are then fitted by response profiles of distinct receptor types found in the sensory neuron to quantify their relative frequency, which is used to parameterize the activation variables for the non-homogeneous stochastic point process cascade model at sub-cellular level. Ultimately, we aim to analyze higher-order spike train statistics under dynamic and steady stimulus conditions to extract parameters for realistic conductance-based single-compartment spiking neuron models, which can account for temporal dynamics involved in the spike generation processes. The analysis and modeling pipeline we propose will be tested with example data sets of sensory neurons. Our data-driven modeling approach is simple to use and flexible, providing a tool which can be employed in diverse experimental settings for various sensory systems. In addition, the resulting single-neuron models provide a tool to explore system parameters related to sensory information processing that are not easily accessible experimentally.

This project is funded under the Institutional Strategy of the University of Cologne within the German Excellence Initiative (UoC Forum).

Deep learning based 3D-segmentation of dendritic spines recorded with two-photon in vivo imaging

Fabrizio Musacchio¹, Pragma Mishra¹, Pranjal Dhole², Shekoufeh Gorgi Zadeh³, Sophie Crux¹, Felix Nebeling¹, Stefanie Poll¹, Manuel Mittag¹, Falko Fuhrmann¹, Eleonora Ambrad¹, Andrea Baral¹, Julia Steffen¹, Miguel Fernandes², Thomas Schultz^{3,4}, Martin Fuhrmann¹

¹Neuroimmunology and Imaging group, German Center for Neurodegenerative Diseases (DZNE), Bonn, Germany

²Image and Data Analysis Facility (IDAF), German Center for Neurodegenerative Diseases (DZNE), Bonn, Germany

³Department of Computer Science, University of Bonn, Bonn, Germany

⁴Bonn-Aachen International Center for Information Technology (B-IT), Bonn, Germany

The automatic detection of dendritic spines in 3D is still a challenging and yet not fully resolved problem with regard to two-photon *in-vivo* imaging. The emergence of convolutional neural networks (CNN) like U-Nets enabled the development of deep learning based segmentation pipelines for biomedical images in general and for dendritic spines in particular. While these pipelines are most suitable for *in-vitro* confocal image data, they provide lower prediction accuracy when applied to volumetric *in-vivo* two-photon images that have a lower signal-to-noise ratio and larger motion artifacts. Thus, researchers of this field still tend to analyze dendritic spines manually, which is time-consuming and prone to human bias. We therefore developed a pipeline for multi-class semantic image segmentation based on a fully convolutional neural network, that specifically targets 3D two-photon *in-vivo* image data. By choosing U-Net as the underlying network architecture, only a few labeled training images (< 50) are required. The U-Net processes 2D images to reduce computation time. A post-hoc 3D connectivity analysis merges the classified spine pixels and reconstructs the 3D morphology. Our pipeline is capable to segment spines from its associated dendrite with 85% accuracy and enables the further analysis of, e.g., spine morphology and spine density.

Developmental speed and network stability advantages may favour an ordered organisation of cortical stimulus preference in primates and carnivores

Zoe Rowe Stawyskyj^{1,2,3}, Michael Sternbach^{1,2,3}, Fred Wolf^{1,2,3,4,5}

¹Georg-August-Universität Göttingen, Göttingen Campus Institute for Dynamics of Biological Networks, Heinrich-Düker-Weg 10, 37073 Göttingen, Germany

²Max Planck Institute for Dynamics and Self-Organization, Göttingen, Germany

³Bernstein Center for Computational Neuroscience Göttingen, Göttingen, Germany

⁴Institute for Dynamics of Complex Systems, Georg-August University, Göttingen, Germany

⁵Max Planck Institute for Multidisciplinary Sciences, Göttingen, Germany

In the mammalian brain, form vision relies on networks of orientation selective neurons in primary visual cortex. Two apparently categorically different organisations of these networks have been found; (1) a spatially organised complex pattern consisting of orientation domains containing local clusters of similarly tuned neurons, and (2) a disordered architecture in which neighbouring neurons exhibit the entire spectrum of preferred orientations. The phylogenetic relationships of the lineages in which these distinct architectures have been demonstrated imply that evolutionary transition between them must have happened in mammalian brain evolution (Ho et al. 2021, Kaschube et al. 2010, Schmidt & Wolf 2021). Here we present theoretical and computational results uncovering potential functional advantages and disadvantages that might have driven these transitions.

We consider potential for representational turnover and robustness of the two architectures using a dynamical systems framework consisting of networks of neurons linked by orientation and distance dependent interactions. Selectivity is then described by order parameters in the symmetry constrained dynamics. The networks converge to stable structures which are attractors in the dynamics. We analysed the number, degeneracy, and topology of the set of attractors as well as the speed and total representational turnover associated with the convergence to the attractor.

We find that when a blanket of inhibition dominates the interaction the stable network structures lie on a manifold of extensive dimensionality consisting of states of the disordered architecture. A transition to spatially ordered states can be induced by strengthening local recurrent excitation. In this regime we find a reduced set of attractors composed of an exponential number of toroidal state manifolds, where the dimension and number of these tori is independent of network size. Considering a large class of dynamical rules for the formation and refinement of a system of orientation domains we find that this regime is singled out by the requirement of minimal representational turnover.

In summary, the disordered architectures belong to an extensively high dimensional attractor set and while this would allow for very fast convergence it would also be more prone to noise driven turnover. Orientation domains by contrast have an attractor set of drastically reduced dimension and hence is intrinsically protected from noise-driven turnover while still remaining optimal for fast convergence. These distinct characteristics translate to selective advantages and disadvantages when an animal lineage evolves in the direction of a visual specialist as happened at the origin of primates and carnivores. Massive investment in

V1 results in a much larger network which would enhance the drift of the disordered architecture. In addition, the number of parameters of the network increases with this expansion potentially requiring additional regularisation to avoid problems analogous to overfitting. Both disadvantages are fixed with the transition to orientation domains.

Dynamic Gain Analysis of Axon Initial Segment Function in High-Bandwidth Population Encoding

Neil Lewis Wesch¹, Elinor Lazarov², Chenfei Zhang¹, Fred Wolf^{1,3}, Andreas Neef^{1,3}

¹ Göttingen Campus Institute for Dynamics of Biological Networks, Georg-August-Universität, Göttingen, Germany

² University Medical Center Göttingen, Pediatrics and Adolescent Medicine, Göttingen, Germany

³ Max Planck Institute for Dynamics and Self-Organization, Göttingen, Germany

The dynamic gain curve (DG) [1] quantifies a neuronal population's ability to participate in oscillatory activity [2] and rapidly fire in response to input changes [3]. It captures the information encoding capability of a population, but depends on single-neuron characteristics [4-6]. The morphological and ion channel properties combined with input statistics co-determine DG in a complex manner. We developed a DG decomposition to facilitate the interpretation of DG and to attribute changes in DG to specific biophysical neuron parameters [7]. The decomposition splits the DG into two sub-threshold and one peri-threshold components, which are easier to interpret. Using DG measurements from mouse neurons of two genotypes, we tested the applicability of the decomposition and found that it indeed separates contributions from different morphological and biophysical parameters.

In the first experiments, disrupted ion channel anchoring at the axon initial segment (AIS), decreased the channel density specifically in the AIS, but not the soma [6]. Decomposition showed that the peri-threshold "spike gain" was altered while the shape of the sub-threshold "effective impedance" was unchanged.

A second set of experiments showed that during neuron maturation (1 to 6 weeks in culture), DG bandwidth increases [8]. This had previously been attributed to AIS maturation [9]. However, our decomposition revealed only weak changes in the AIS-associated "spike gain"; instead, the apparent bandwidth increase was caused by dendrite-associated attenuation in the "effective impedance".

In summary, using targeted manipulation of axonal properties we could confirm that DG decomposition allows us to identify the sub-cellular origin of changes to the DG function. The AIS supports high-frequency (>100 Hz) DG bandwidth already after the first week in vitro, whereas the dendrite growth and the associated suppression of low-frequency (<30 Hz) input continues for weeks. Physiological interpretability makes DG measurements an ideal tool to evaluate changes to the AIS in spectrinopathies, neurodegeneration, and AIS plasticity.

[1] Knight (1972) *J. Gen. Physiol.*

[2] Geisler, Brunel, & Wang (2005) *J. Neurophysiol.*

[3] Tchumatchenko, Maylshev, Wolf, & Volgushev (2011) *J. Neurosci.*

[4] Eyal, Mansvelder, de Kock, & Segev (2014) *J. Neurosci.*

[5] Merino, Leon-Pinzon, Stühmer, & Neef (2021) *PNAS*

[6] Lazarov, Dannemeyer, Feulner, Enderlein, Gutnick, Wolf, & Neef (2018) *Sci. Adv.*

[7] Zhang, Revah, Wolf, & Neef (2022) *bioRxiv*

[8] Lazarov et al. (in preparation)

[9] Nikitin, Bal, Malyshev, Ierusalimsky, Spivak, Balaban, & Volgushev (2017) *Front. Cell. Neurosci.*

Efficient control of oscillations and synchrony in computational models of neural dynamics

Lena Salfenmoser¹, Klaus Obermayer^{1,2}

¹Technical University of Berlin, Neural Information Processing Group

²Bernstein Center for Computational Neuroscience Berlin

Nonlinear models of neural population dynamics typically describe the activity of an ensemble of neurons in terms of a population activity x ("state variable"). We couple different models of neural dynamics to external inputs u ("control") to simulate stimulation. A differential equation determines the time evolution of x ,

$$x' = h(x, u),$$

where x' is the time derivative of x . We want to stimulate such dynamical systems such that they evolve in a desired way. Mathematically, we want to design control signals that are optimal with respect to a cost functional F ,

$$u^* = \operatorname{argmin}_u F.$$

This optimization problem is solved with numerical methods, which compute solutions that satisfy the Pontryagin maximum principle [1,2]. F typically trades accuracy with respect to a target activity (F_1) against the strength of the control input (F_2),

$$F = F_1 + F_2$$

A limitation of this approach is the definition of F_1 as the integrated deviation of the state variable x from a predefined target trajectory χ , Eq. (3) (see Figure). This definition is primarily useful for constant or slowly varying non-oscillatory targets, see Figure, and has successfully been applied to an E-I motif in Ref. [3]. However, the definition of Eq. (3) is overly restrictive; often one would like to specify "higher-level" properties of the dynamics, such as oscillations at a given frequency, or synchrony of networks of coupled neural populations, independent of the exact shapes of the trajectories. We study novel approaches to define F_1 to enforce such activity patterns.

To enforce oscillations with a target period τ of a single neural population, we suggest two cost functionals:

1. The **auto-correlation cost** F_{ac} , Eq. (4)
2. The **phase cost** F_{phase} , Eq. (5)

Above are minimal if $x(t) = x(t-\tau)$.

To enforce synchrony in a network of N nodes, we suggest three cost functionals:

1. The **network cross-correlation cost** $F_{cc,N}$, Eq. (6)
2. The **network phase cost** $F_{\text{phase},N}$, Eq. (7)
3. The **network variance cost** $F_{\text{var},N}$, Eq. (8)

Above are minimal if all nodes are in the same oscillator phase.

In a previous study [4], we successfully applied $F_{cc,N}$ to a network of FitzHugh-Nagumo oscillators. We now study all above cost functionals. To our knowledge, these novel ideas have not yet been tested in similar nonlinear optimal control problems.

- [1] D. Kirk. "Optimal control theory: an introduction". Dover Books on Electrical Engineering Series. Dover Publications, 2004.
- [2] E. Casas et al. "Sparse optimal control of the Schlögl and FitzHugh-Nagumo systems". Comput. Appl. Math. 13, 2013.
- [3] L. Salfenmoser, K. Obermayer. "Nonlinear optimal control of a mean-field model of neural population dynamics". Front. Comput. Neurosci. 16, 2022.
- [4] T. Chouzouris et al. "Applications of optimal nonlinear control to a whole-brain network of FitzHugh-Nagumo oscillators". Phys. Rev. E 104, 2021.

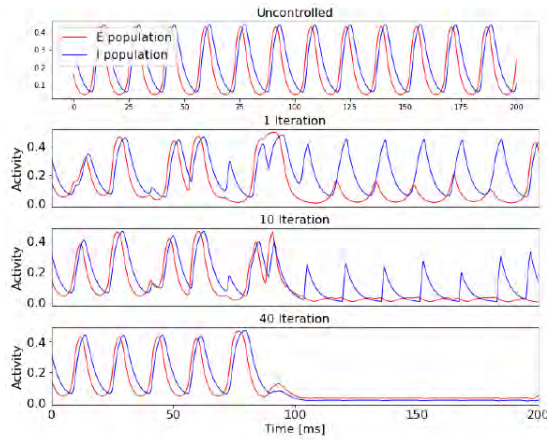

$$\mathcal{F}_1 = \frac{1}{2} \int_{t_0}^T \|x(t) - \chi(t)\|^2 dt \quad (3)$$

$$F_{\text{acc}} = - \int_{t_0}^T x(t) \cdot x(t - \tau) dt \quad (4)$$

$$F_{\text{phase}} = - \int_{t_0}^T \left| e^{i\varphi(t)} + e^{i\varphi(t-\tau)} \right| dt \quad (5)$$

$\varphi(t)$ is the oscillator phase of x

$$F_{cc,N} = - \frac{1}{N^2} \sum_{n,l=1}^N \int_{t_0}^T (x_n - \bar{x}) \cdot (x_l - \bar{x}) dt \quad (6)$$

$$\text{with } \bar{x} = \frac{1}{N} \sum_{n=1}^N x_n$$

$$F_{\text{phase},N} = - \frac{1}{N} \int_{t_0}^T \left| \sum_{n=1}^N e^{i\varphi_n(t)} \right| dt \quad (7)$$

$$F_{\text{var},N} = \frac{1}{N} \sum_{n=1}^N \int_{t_0}^T (x_n - \bar{x})^2 dt \quad (8)$$

Left: The controlled activity of the E (red) and I (blue) population (Wilson-Cowan model) for switching from oscillations to a down-state. We study a 200 ms simulation. We initialize an oscillating system and force it into a down-state after 100 ms. We iteratively compute the

optimal control and show the controlled activity after 0, 1, 10, and 40 iterations. The activity approaches zero from 100 ms onwards for higher iteration numbers. Right: Equations (3) - (8)

Identification and Removal of Artifacts in Massively Parallel Recordings

Jonas Oberste-Frielinghaus^{1,2}, Simon Essink^{1,2}, Alexander Kleinjohann^{1,2}, Julia Sprenger³, Junji Ito¹, Sonja Grün^{1,2}

¹Institute of Neuroscience and Medicine (INM-6), Institute for Advanced Simulation (IAS-6) and JARA-Institute Brain Structure-Function Relationships (INM-10), Jülich Research Centre, Jülich, Germany

²Theoretical Systems Neurobiology, RWTH Aachen University, Germany

³Institut de Neurosciences de la Timone, CNRS, Marseille, France

State-of-the-art electrophysiology recordings via multi-electrode arrays [1, 2] allow the measurement of hundreds of channels in parallel. To detect single unit activity, the raw signals recorded at a high sampling rate (e.g. 30 kHz) are high-pass filtered and then spike sorted, resulting in hundreds of single units.

We aimed to analyze fine temporal spike correlations (ms scale), e.g. spike synchrony, to identify cell assemblies. We found in such multiple parallel spike data an unusual amount of spike synchrony, by observing the population histogram, i.e. the histogram the spike counts across the neurons in bins of 1-5ms. The distribution of these counts (called complexity distribution [3]) showed excessive higher-order synchrony. We compared our finding to the expected chance synchrony by looking at the complexity distribution of data created by spike dithering [5]. To elucidate if our results indeed stem from neuronal synchrony, we computed the complexity distribution for both, the experimental and the independent dithered data, on the sampling rate resolution (1/30 ms bin size). We assumed that neuronal synchrony would be visible only on ms scale but not on the time scale of the sampling frequency. We found excess higher-order synchrony even on the sampling rate time scale. Here we came to the conclusion that there are artifacts in the data and called those synchronous artifact events 'synchrofacts'.

These artifacts interfere with our analysis for neuronal spike synchrony, so we wanted to get rid of them by removing all events that are synchronous on the 1/30 ms bin size. However, our synchrony analysis using the Population Unitary Event (PopUE) analysis (similar to [4], but across simultaneously recorded neuron pairs) on a larger time scale of 1-5 ms revealed an overall lack of synchrony, indicating that this procedure also removed many non-artifact synchronous spikes.

To find a smarter way of removing the artifacts, we went back to the high-pass filtered raw signal, calculated the correlation coefficient (CC) between any raw channel and any other channel, and noted very high CCs (up to 0.8). Additionally, we extracted threshold crossing events (TCEs), i.e. potential spikes from these signals, and identified synchronous TCEs on the level of 1/30 ms time bin.

We see (Fig. 1) that channels with high CCs tend to have more synchrofacts. We generally recommend avoiding channels with high correlations by e.g. using only channels with a CC below 0.55. Since we experienced that synchrofacts survive spike sorting, we recommend removing, before sorting, all channels with high amounts of synchrofacts, and channels with low number of TCEs.

References:

- [1] Brochier et al. (2018) Scientific Data, 5:180055.
- [2] Chen et al. (2022) Scientific Data, 9:77.
- [3] Grün, Diesmann, Abeles (2008) Lecture Notes in Computer Science, 5286:96-114.
- [4] Maldonado et al. (2008) J Neurophysiol, 100:1523-32.
- [5] Date et al. (1999) Technical Report, Brown University

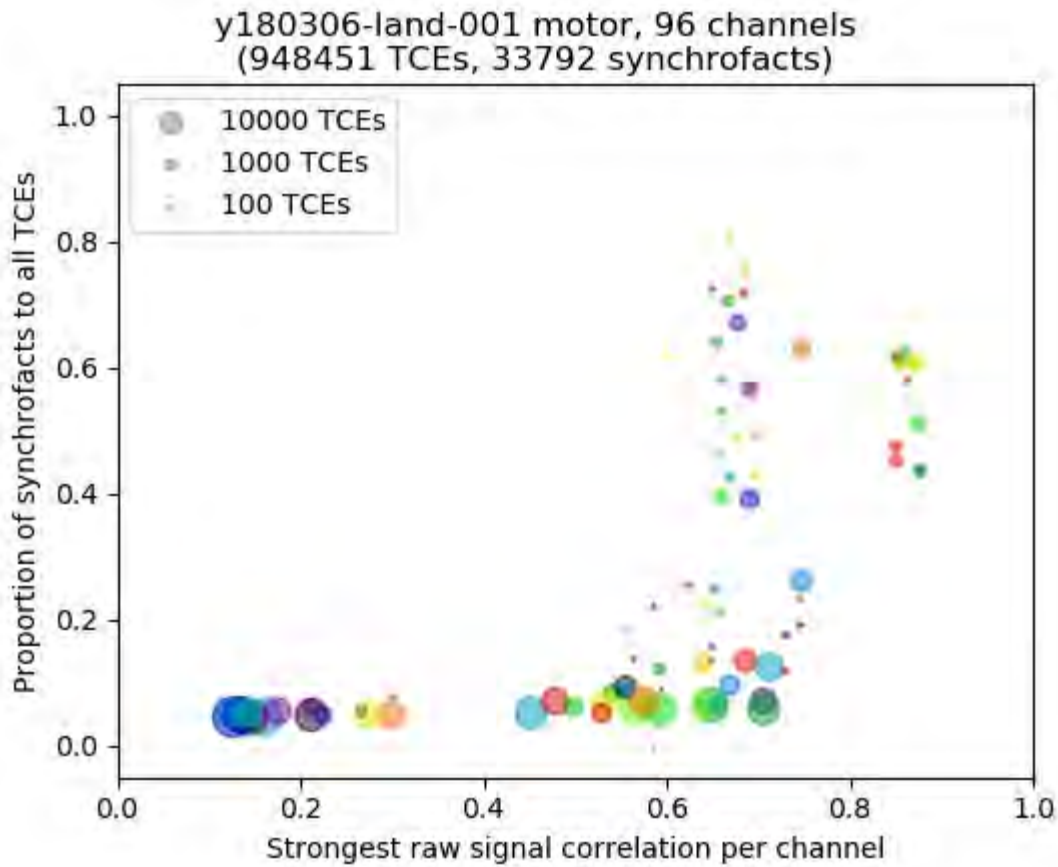

Fig. 1: Relation of correlations of raw signals to the amount of synchrofact TCEs. The x-axis indicates the highest CC of any single raw channel with any other channel. The y-axis shows the proportion of TCEs of the reference channel in synchrofacts relative to all TCEs therein. So there are as many dots as channels. The radius of the dot shows the amount of TCEs in the channel.

Mesoscopic modelling of large-scale networks of leaky integrate-and-fire neurons

Jan-Eirik Welle Skaar¹, Hans E. Plesser^{1,2}, Gaute T. Einevoll^{1,3}, Kristin Tøndel¹

¹Norwegian University of Life Sciences, Faculty of Science and Technology, Ås, Norway

²Institute of Neuroscience and Medicine (INM-6) and Institute for Advanced Simulation (IAS-6) and JARA- Institut Brain Structure-Function

³Department of Physics, University of Oslo, Oslo, Norway

Simulating large networks of neurons is computationally demanding. When modelling large networks, one may be mostly interested in one or a specific populations of neurons. Other populations of lesser interest may be modelled at a coarser scale.

Recently developed *mesoscopic* population models have been shown to accurately be able to capture the population averaged spiking activities of networks of spiking generalized leaky integrate-and-fire neurons (Schwalger et al. 2017). Also yielding an explicit probability population averaged spiking activity, this mesoscopic model is statistically tractable, and can be used to infer mesoscopic model parameter values consistent with observed population spiking activity (René et al. 2020). We apply such statistical inference methods to fit mesoscopic models to large-scale networks of regular leaky integrate-and-fire neurons, and investigate how well it can be used to coarse-grain such models.

René et al. *Neural Comput* 2020; 32 (8): 1448–1498.

Schwalger et al. *PLoS Comput Biol* 13(4): e1005507.

Acknowledgement:

This work has received funding from the European Union's Horizon 2020 Framework Programme for Research and Innovation under Specific Grant Agreement 945539 HBP SGA3 (HEP, GTE).

Modeling the electrosensory periphery of *Eigenmannia virescens*

Sarah Mayer¹, Jan Benda¹, Jan Grewe¹

¹Eberhard Karls Universität Tübingen, Neuroethology, Auf der Morgenstelle 28, 72076 Tuebingen, Germany

The electrosensory system of the electric fish is a well established model system for electrophysiological studies and computational analyses. Electric fish such as *Eigenmannia virescens* surround themselves with an electric field by regularly discharging their electric organ (Electric organ discharge, EOD). At the same time, cutaneous electroreceptors, namely the tuberous (active) and ampullary (passive) electroreceptors, sense distortions of the own field as well as exogeneous fields. These signals are evaluated and used in the context of navigation, prey detection and electrocommunication. First, peripheral information undergoes a non-linear transformation into on- and off pathways when relayed to pyramidal neurons in the hindbrain. There, active and passive information is kept separated. Then, on the level of the midbrain (torus semicircularis, the homologue to the inferior colliculus), these parallel streams are integrated. So far, none of these transitions are fully understood.

As a first step to address these fundamental transitions of a neuronal code we here aim at modeling the electrosensory periphery by fitting leaky integrate-and-fire (LIF) models to individual electroreceptor afferents, based on spontaneous and stimulus driven response properties. For this we characterize the response properties of the recorded neurons and then individually fit models using the simulation-based-inference approach¹.

Creating such a library of realistic model neurons will enable us to analyze computational principles. In particular to test the hypothesis of the beneficial role of integrating information carried by the active and the passive electrosensory system in the context of electrocommunication in *Eigenmannia*².

[1] A. Tejero-Cantero, J. Boelts, M. Deistler, J.-M. Lueckmann, C. Durkan, P. J. Gonçalves, D.S. Greenberg, and J. H. Macke, Journal of Open Source Software, 2021

[2] A. Stoeckl, F. Sinz, J. Benda, and J. Grewe, J. Neurophysiol., 2014

NEST-SONATA: Fast parallel instantiation of explicitly specified large-scale neuronal network models

Hans Ekkehard Plesser^{1,2}, Nicolai Haug¹, Håkon Bakke Mørk¹, Stine Brekke Vennemo¹,
Susanne Kunkel^{1,3}, Kael Dai⁴, Anton Arkhipov⁴

¹Norwegian University of Life Sciences, Faculty of Science and Technology, PO Box 5003, 1432 Ås, Norway

²Institute of Neuroscience and Medicine (INM-6) and Institute for Advanced Simulation (IAS-6) and JARA- Institut Brain Structure-Function Relationships (INM-10), Jülich Research Centre, Jülich, Germany

³ Neuromorphic Software Eco Systems (PGI-15), Jülich Research Centre, Jülich, Germany

⁴Allen Institute for Brain Science, Seattle, WA, USA

Large-scale brain models require parallel computers for simulation to provide enough memory to represent network connectivity. Efficient use of energy-intensive high-performance computing systems for brain simulation thus depends on fast instantiations of large and complex network connectivity on massively parallel computers. While significant progress has been made in developing scalable data structures and algorithms for storing and accessing connections in parallel [1-5], efficient parallel instantiation of such networks has so far received less attention in the scientific literature. Network connectivity can be defined either rule-based [6] or through explicit tabulation of individual connections, for example by using the SONATA file format [7], on which we focus in this work. Even for models of limited size and complexity, such as a partial mouse-brain model with more than 9 million point neurons connected by 25 billion synapses, SONATA specification files comprise nearly 500 GB of data in mostly binary format (HDF5).

Building on the large-scale network representation and simulation technology of the NEST simulator [8], we have investigated efficient techniques for the MPI- and thread-parallel instantiation of network connectivity from SONATA network specifications. Optimal performance is achieved if the network specification is sorted by connection targets and provides index tables. In this case, each MPI rank in a parallel simulation reads only data for connections to be created on that rank, before connections are created by all threads on a rank. Data is read in blocks to achieve a balance between number of read operations and memory overhead. In this case, a network represented by some 500 GB of explicit connectivity specification can be instantiated on a moderate compute system (32 compute nodes with 128 CPU cores each) in minutes.

[1] Kunkel S et al (2012) Meeting the memory challenges of brain-scale network simulation. *Front. Neuroinform.* 5:35. doi: 10.3389/fninf.2011.00035

[2] Kunkel S et al (2014) Spiking network simulation code for petascale computers. *Front. Neuroinform.* 8:78. doi: 10.3389/fninf.2014.00078

[3] Ippen T et al (2017) Constructing Neuronal Network Models in Massively Parallel Environments. *Front. Neuroinform.* 11:30. doi: 10.3389/fninf.2017.00030

[4] Jordan J et al (2018) Extremely Scalable Spiking Neuronal Network Simulation Code: From Laptops to Exascale Computers. *Front. Neuroinform.* 12:2. doi: 10.3389/fninf.2018.00002

[5] Pronold J et al (2022) Routing brain traffic through the von Neumann bottleneck: Efficient cache usage in spiking neural network simulation code on general purpose computers. *Parallel Computing* 113:102952 doi: 10.1016/j.parco.2022.102952

[6] Senk J et al (2022) Connectivity concepts in neuronal network modeling. *PLoS Comput Biol* 18(9):

e1010086 doi: 10.1371/journal.pcbi.1010086

[7] Dai K et al (2020) The SONATA data format for efficient description of large-scale network models. PLoS Comput Biol 16(2): e1007696 doi: 10.1371/journal.pcbi.1007696

[8] Gewaltig M-O & Diesmann M (2007) NEST (Neural Simulation Tool) Scholarpedia 2(4):1430 doi: 10.4249/scholarpedia.1430

This work was funded by the Allen Institute (KD, AA) and has received funding from the European Union's Horizon 2020 Framework Programme for Research and Innovation under Specific Grant Agreement 945539 (HBP SGA3; HEP, NH, HBM, SBV, SK). We acknowledge the use of Fenix Infrastructure resources, which are partially funded from the European Union's Horizon 2020 research and innovation programme through the ICEI project under the grant agreement No. 800858.

Neural dynamics underlying human vocalization

Vera A. Voigtländer^{1,2,3,4}, Florian Sandhaeger^{1,2,3,4}, Dawid J. Hawellek^{1,2,3,6}, Steffen R. Hage^{2,5}, Markus Siegel^{1,2,3}

¹Department of Neural Dynamics and Magnetoencephalography, Hertie Institute for Clinical Brain Research, University of Tübingen, Germany

²Centre for Integrative Neuroscience, University of Tübingen, Germany

³MEG Center, University of Tübingen, Germany

⁴Graduate Training Centre of Neuroscience, International Max Planck Research School, University of Tübingen, Germany

⁵Dept. of Otolaryngology-Head and Neck Surgery, Hearing Research Centre, University of Tübingen, Germany

⁶Roche, Pharmaceutical Research and Early Development, Roche Innovation Center Basel, Basel, Switzerland

Human speech allows to convey information via different execution forms. On the behavioral level, speech content is independent from its motor production. However, it remains unclear whether such a content dimension can be found on the neural level and whether it is possible to dissociate it from the motor dimension. To address this, we recorded magnetoencephalography (MEG) in human subjects performing a rule-based vocalization task that allowed us to dissociate content (one of two vowels) and production (overt or covert).

Non-Stationary recurrent neural networks for reconstructing computational dynamics of rule learning

Max Ingo Thurm¹, Georgia Koppe^{1,4}, Eleonora Russo^{1,5}, Florian Bähler^{1,3,4}, Daniel Durstewitz^{1,2}

¹Dept. of Theoretical Neuroscience, Central Institute of Mental Health, Mannheim, Germany

²Faculty of Physics and Astronomy, Heidelberg University, Germany

³Department of Psychiatry and Psychotherapy, Central Institute of Mental Health, Medical Faculty Mannheim, Heidelberg University, Mannheim, Germany

⁴Clinic for Psychiatry and Psychotherapy, Central Institute of Mental Health, Mannheim, Germany

⁵Department of Psychiatry and Psychotherapy, University Medical Center, Johannes Gutenberg University, 55131, Mainz, Germany

The ability to update behavior in unfamiliar environments or upon shifting contingencies is essential for survival. The medial prefrontal cortex (mPFC) has been linked to behavioral flexibility, rule learning, and uncertainty detection in a number of studies. Animals learning a new rule, or switching between rules, show abrupt changes in their behavioral learning curves, accompanied by sharp transitions in their neuronal population states.

Here, we aim to extract the computational and dynamical mechanisms behind these behavioral and neurophysiological phenomena during rule learning by novel deep learning techniques. Toward this goal, we modify piecewise-linear recurrent neural networks (PLRNNs), a tractable and interpretable framework for reconstructing dynamical systems from empirical time series data like multiple single-unit (MSU) recordings. PLRNNs in their vanilla form assume the system's dynamics to have a fixed set of parameters. In contrast to this, a natural assumption for any learning task is that the network's connectivity parameters adjust to new environmental contingencies leading to new behavioral traits. Therefore, we create a non-stationary version of the PLRNN with a time-varying weight connectivity matrix on which we impose smoothness and continuity priors during training. We used this methodology to reconstruct the changing neuronal dynamics, on a trial-by-trial basis, from MSU recordings of the rodent's mPFC while the animals performed a probabilistic rule-learning task.

After training the non-stationary PLRNN on the neurophysiological data, we show that a) it can accurately capture a variety of single-unit firing rate profiles, b) the latent space of the PLRNN contains as much information about behavioral task events as the original MSU activity, c) generated trial-to-trial trajectories for both rules closely match across-trial trajectories directly obtained from the data and d) change points detected in PLRNN-simulated activity tightly correlate with those directly identified from the original MSU recordings. Thus, after training the PLRNNs became a kind of formal surrogate for the real data, behaving in dynamically equivalent ways.

We further discovered that, while containing minimal information about other task events, trial-specific connectivity matrices enable almost perfect rule-type decoding. In fact, alterations in the connectivity matrix of the PLRNN seemed to closely follow changes in the animal's behavior.

We conclude that the non-stationary PLRNN offers a powerful analysis framework for non-stationary neuronal processes which allows for new insights into the underlying computational dynamics.

Acknowledgements

This work was funded by the German Research Foundation (DFG) within the FOR5159 (SP8, Du 354/14-1) and DFG individual grand Du 354/10-1.

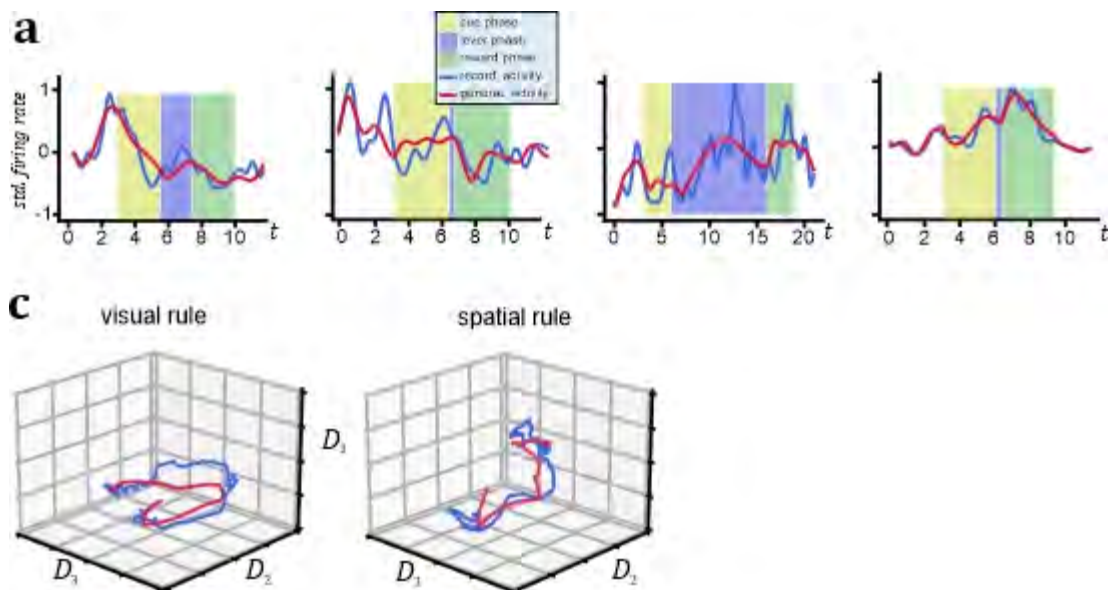

Example of reconstructed unit activity profiles and neuronal trial trajectories

Physiologically-inspired neurodynamical model for anorthoscopic perception

Martin A. Giese¹, Anna Bognar², Rufin Vogels²

¹HIH / CIN, Uniklinik Tübingen, Computational Sensomotrics, ¹Tübingen, Germany

²Dept. of Neuroscience / Leuven Brain Inst., KU Leuven, Belgium

Objects presented sequentially, translating behind a narrow slit are readily recognized by humans (anorthoscopic perception). This perceptual capability is not accounted for by standard deep neural network (NN) models of visual object recognition. **METHODS:** We developed a deep NN that recognizes anorthoscopically presented body shapes, and reproduces properties of IT neurons during anorthoscopic perception (Bognar & Vogels, 2021). The initial layers of the model correspond to an Image net-trained standard deep NN model (VGG16). The intermediate levels of the model consist of special nonlinear fragment units, which are selective for highly visible features during training and testing. The receptive fields of these units are strongly elongated in horizontal and vertical orientation. Neurons in the next layer implement maximum pooling of outputs of fragment units of the same type at different spatial locations, resulting in position invariance. These units are embedded within a recurrent network with symmetric lateral connections with center-surround topology. Neurons in the output level of the model pool the responses of the mid-level units belonging to the same shape over time and fragments belonging to the same shape. In addition, these output neurons are inhibiting each other, realizing a winner-takes-all competition between different shapes. **RESULTS:** Opposed to standard DNNs the proposed architecture accounts for anorthoscopic perception after training with normal shape stimuli. At the same time, it reproduces in detail dynamic activity profiles of real neurons in the superior temporal sulcus at the level of single-cell and population activity. **CONCLUSION:** Popular standard DNN models of the visual cortex might not be able to reproduce fundamental properties of primate shape recognition, which can be modeled by simple physiologically plausible neural circuits.

Acknowledgements: ERC 2019-SyG-RELEVANCE-856495 , HFSP RGP0036/2016, BMBF FKZ 01GQ1704.

Rats adapt optimally to changes in reinforcement probabilities, stimulus presentation probabilities and discrimination difficulty in a perceptual decision making task

Luis de la Cuesta Ferrer¹, Christina Koß², Andrea Dietl¹, Frank Jäkel², Maik C. Stüttgen¹

¹University Medical Center of the Johannes Gutenberg University of Mainz, Institute of Pathophysiology

²Technical University of Darmstadt, Center for Cognitive Science

In a world full of uncertainty in which resources are scarce, animals need to categorize objects (e.g., edible vs. non-edible food items), track environmental variables, (e.g., food availability), and flexibly adapt to changing circumstances in order to efficiently guide action. In the lab, this can be studied by means of perceptual decision making tasks with blockwise changes of reinforcement schedules. In these tasks, statistical modelling of the environment allows computation of the optimal response strategy to serve as a benchmark for gauging subjects' performance. Indeed, several previous studies have reported that animals quickly adapt to changing contingencies, often even maximizing long-term reward. Nonetheless, the cognitive algorithm underlying adaptive behaviour in these situations is largely unknown and existing learning algorithms have not been systematically investigated.

Here, we aimed at comparing three different learning models: an optimal account as calculated from Signal Detection Theory, a greedy income-based model (that only learns after rewards) and an error-based account (that only learns after errors). Rats were trained on a sound discrimination forced choice task. In several conditions, discrimination difficulty, stimulus presentation probability and reward probability were manipulated. The conditions were constructed such that the three different accounts yielded divergent predictions. We found that, despite rats' steady state performance was well explained by the optimal account, none of the mechanistic models tested here was able to explain how they did it, calling for further investigations into the cognitive algorithm underlying adaptive perceptual choice behaviour.

Relating the orientation of cortical traveling waves and co-occurring spike patterns

Sven Krauße^{1,2}, Robin Gutzen^{1,2}, Alessandra Stella¹, Thomas Brochier³, Alexa Riehle^{3,1},
Sonja Grün^{1,2}, Michael Denker¹

¹Institute of Neuroscience and Medicine (INM-6) and Institute for Advanced Simulation (IAS-6) and JARA-Institut Brain Structure-Function Relationships (INM-10), Jülich Research Centre, Jülich, Germany

²Theoretical Systems Neurobiology, RWTH Aachen University, Aachen, Germany

³Institut de Neurosciences de la Timone (INT), UMR 7289, CNRS-Aix Marseille Université, 13005 Marseille, France

To study information processing in the cerebral cortex, multiple complementary approaches exist to characterize the coordinated population dynamics. One approach is to investigate the correlated spiking activity of individual neurons. Another approach is to analyze the local field potential (LFP) as an aggregate signature of the neuronal population dynamics. However, it is an open question how these two scales of observation relate to each other.

The LFP activity in the motor cortex exhibits functionally relevant oscillations in the beta frequency band (e.g. [1]). It has been shown that the phases of beta oscillations typically form propagating waves [2, 3]. These are commonly observed as planar waves that travel across the primary motor cortex, preferably on a rostral-caudal axis [3].

Significant patterns of precise synchronous spiking (on a ms scale) that have been identified in the motor cortex [4] also display a preferred spatial orientation [5]. Indeed, estimated functional connectivity measured from spike trains using a Granger causality approach occurs in a directed manner that aligns with the mean propagation axis of LFP waves [6]. These findings raise the question of a direct relation between a single spike pattern and a co-occurring LFP wave.

To investigate this question, we analyzed multi-electrode-array (Utah array) recordings of the motor cortex (MI/PMd) from a macaque monkey during an instructed reach-to-grasp task [7]. In the beta-band LFP recordings (15-25 Hz), we identified wave directions and planarity based on the gradient of the instantaneous phase using an automated analysis pipeline approach (Cobrawap) [8,9]. Independently, we detected all repeating synchronous spike patterns in the same data sets using the SPADE method [10, 11]. We identified the dominant spatial axis of the synchronous spike pattern as the first eigenvector of a principal component analysis (PCA) over the electrode grid coordinates of the involved neurons. We show that this axis tends to be perpendicular to the propagation direction of simultaneously occurring planar waves (cf. Fig.). This relationship does not only appear on average as suggested by previous work [5,6] but also on a pattern-by-pattern basis. Finally, we discuss extensions of this analysis approach to non-synchronous spike patterns.

References:

- [1]: Kilavik et al. (2012). doi:10.1093/cercor/bhr299
- [2]: Denker et al. (2018). doi:10.1038/s41598-018-22990-7
- [3]: Rubino et al. (2006). doi:10.1038/nn1802
- [4]: Riehle et al. (1997). doi:10.1126/science.278.5345.1950
- [5]: Torre et al. (2016). doi:10.1523/JNEUROSCI.4375-15.2016
- [6]: Takahashi et al. (2015). doi:10.1038/ncomms8169

- [7]: Brochier et al. (2018). doi:10.1038/sdata.2018.55
 [8]: Gutzen et al. (2021). doi:10.12751/NNCN.BC2020.0030
 [9]: Capone et al. (2022). doi:10.48550/arXiv.2104.07445
 [10]: Torre et al. (2013). doi:10.3389/fncom.2013.00132
 [11]: Stella et al. (2022). doi:10.1523/ENEURO.0505-21.2022

Acknowledgements:

Founded by EU Grant 785907 (HBP SGA2), EU Grant 945539 (HBP SGA3), ANR Grant GRASP (France), Helmholtz IVF Grant ZT-I-0003 (HAF), and the Joint-Lab “Supercomputing and Modeling for the Human Brain”.

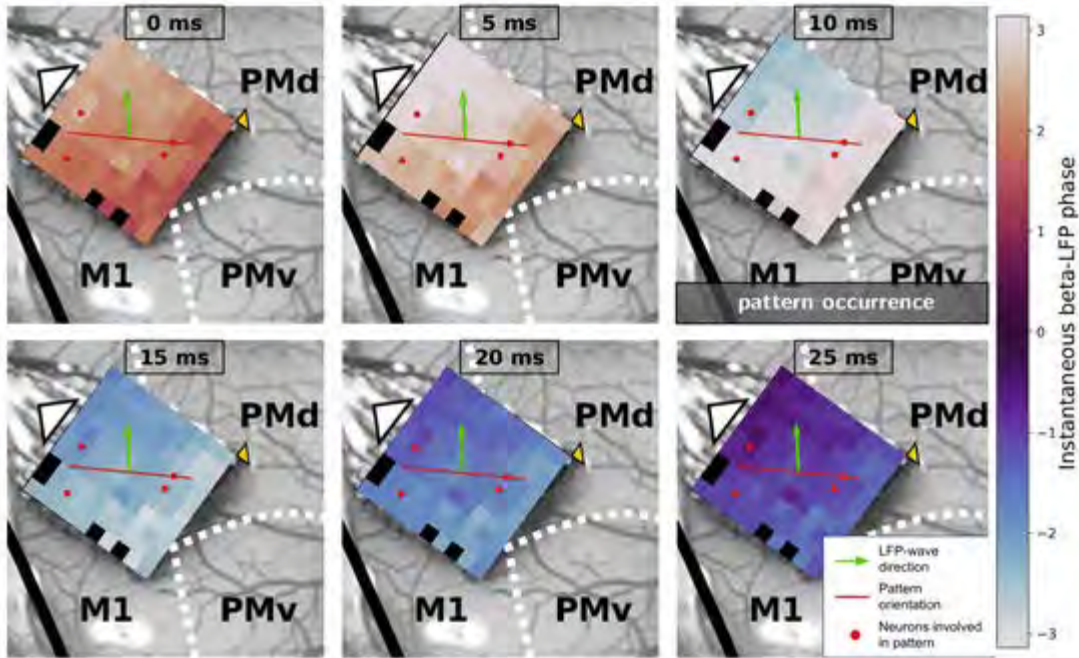

5ms interval snapshots of a wavefront (LFP phases color coded) with its direction of propagation (green arrow) and a spike pattern (red dots) with its dominant spatial axis (red line) on the electrode grid. Pattern occurrence at 10ms.

Robustness of a self-regulating neuronal network model in response to mutated ion channels

Philippa Hennessey¹, Jan Benda^{1,2}, Lukas Sonnenberg¹

¹University of Tübingen, Institute of Neurobiology, Neuroethology Lab, Germany

²Bernstein Center for Computational Neuroscience, Tübingen, Germany

Mutations in ion channels can lead to a variety of neurological disorders such as epilepsy, ataxia, intellectual disability, or pain disorders. The effect of ion channel mutations on ionic current properties is usually assessed in heterologous expression systems. But the impact of these changes on neuronal firing or even at network state is hard to predict and experimental validation is expensive and time-consuming.

Simulating neurons is an important and growing tool for investigating the effects of ion channel variants on these higher levels. However, most models are static and do not reflect the capability of a neuron or neural network to adjust itself to altered conditions via homeostatic processes. Yet, these are important compensation mechanisms that can increase the robustness against pathological changes.

We built a dynamic thalamocortical network model which adjusts its ion channel expression rates and synaptic strengths to reach a stable firing rate. To implement this in a biologically plausible way the model adjusts these variables until a type-dependent calcium concentration is reached.

We applied changes to the model's ionic current properties that are associated with epilepsy and determined the resulting stability and coding capabilities of the network.

This approach could be utilized in the future to predict candidate medical treatments more realistically and elucidates mechanisms of robustness and their limitations in biological neural networks.

Spontaneous Initiation of Spreading Depression in a Heterogeneous Network

Allison Harris¹, Wolfgang Stein²

¹Illinois State University, Department of Physics, Campus Box 4560, 61790 Normal, USA

²Illinois State University, School of Biological Sciences, Campus Box 4120, 61790 Normal, USA

An estimated 1 billion people worldwide experience migraine, a neurological disorder that manifests as intense headache pain often accompanied by extreme sensitivity to light and sound. While treatment options have increased in recent years, the underlying cause of migraine remains a mystery. There is evidence that migraine is preceded, and perhaps initiated, by a slowly traveling wave of inactivation in the cortex, referred to as cortical spreading depression (CSD). The hallmark features of CSD are a rapid increase in firing frequency of the cortical cells followed by a loss of spiking. This inactivity then propagates slowly through the cortex as a result of the loss of potassium homeostasis in the extracellular space. Numerous biological and computational studies have focused on the mechanisms of the spread, possible ways to halt it, and the underlying cellular conditions that lead to CSD. However, the larger-scale dynamics and mechanisms that trigger CSD remain poorly understood.

We know from familial hemiplegic migraine (FHM-2) that defects in the glial cell Na^+/K^+ pump can play a key role in the initiation of CSD in these patients. It is not clear to what extent the severity of the defects, or their spatial distribution within the cortical network, affects the spontaneous initiation of CSD. We aim to understand how local inhomogeneities in pump strength can lead to the initiation of CSD in some locations but not others. We used a computational model of a network of 25 neuron-astrocyte pairs to examine the effect of the astrocyte Na^+/K^+ pump strength on the initiation of CSD. Neuron-astrocyte pairs were coupled through the extracellular space, allowing for the diffusion of ions across the network. We first identified a threshold pump strength in a network of cells with homogeneous strengths, above which CSD was never triggered.

In all of the following networks, the average pump strength was kept above this threshold value, but individual cells could deviate from the average. We asked whether these spatial fluctuations were sufficient to elicit CSD. Introducing a single neuron-astrocyte pair with a dramatically reduced pump strength (50% of the threshold) into the homogeneous network was insufficient to elicit CSD. However, when we introduced inhomogeneity into the network by using astrocytes with randomly distributed pump strengths, CSD was elicited. This was the case even though the below-threshold astrocytes were surrounded by their above-threshold counterparts, and their deviations were within 50% of the threshold (i.e., smaller than for the single neuron approach above). The location of the CSD initiation correlated with regions of low pump strength, suggesting that the combined effect of several below-threshold pump efficacies is sufficient to overwhelm a network with an average pump strength that should prevent CSD. In all cases, the neuronal inactivation spread throughout the entire network and no region of high pump strength was able to interrupt the spread.

In summary, our data indicate that an inhomogeneous distribution of Na^+/K^+ pump strengths can lead to spontaneous initiation of CSD in networks whose global properties imply stability.

Poster Topic

T27: Techniques and Demonstrations

- [T27-1A](#) A flexible and versatile system for multi-color fiber photometry and optogenetic manipulation
Andrey Formozov, Alexander Dieter, Simon Wiegert
- [T27-2A](#) A web portal facilitating FAIRification of research data in neuroscience
Robert Kossen, Luca Freckmann, Christian Henke, Linus Weber, Ulrich Sax, Sara Y. Nussbeck, Harald Kusch
- [T27-3A](#) Acousto-optic voltage imaging in awake mice with JEDI-2P

Denes Palfi, Balazs Chiovini, Viktoria Kiss, Zsolt Mezriczky, Anna Mihaly, Katalin Ocsai, Balazs J. Rozsa
- [T27-4A](#) Automated Patch Clamp and CryoEM Team up for Mode of Action Elucidation of Two *D. melanogaster* Slo Modulators

Andreas Brockmann
- [T27-5A](#) Bayesian Oracle for bounding information gain in neural encoding models
Konstantin-Klemens Lurz, Mohammad Bashiri, Fabian Sinz
- [T27-6A](#) Channelrhodopsin library screening by automated planar patch-clamp recordings facilitates the development of the future optical cochlear implant
Alexey Alekseev, Maria Zerche, Tobias Moser, Thomas Mager
- [T27-7A](#) Characterization of mouse enteroendocrine cell subtypes
Matea Krizman, Benjamin H. Cooper, Cordelia Imig
- [T27-8A](#) Development of an optogenetic dimerization tool to control mitochondrial movement
Juliana Groß, Olivia A. Masseck
- [T27-1B](#) Dissecting local changes in the coding and non-coding neuronal transcriptome revealed by subcellular transcriptomics
Jennifer Heck, Valeriy Pak, Aliaksandr Halavatyj, Arif Ul Maula Khan, Kyung-Min Noh, Sinem K. Saka
- [T27-2B](#) Dual color imaging in freely-behaving rodents using head-mountable one photon miniscope

Norbert Hogrefe, Srishti Gulati, Kevin Zitelli, Douglas Ollerenshaw, Alice Stamatakis

[T27-3B](#) Effects of 24h of 2g-hypergravity on mouse blood brain barrier
David Dubayle, Jean-Luc Morel

[T27-4B](#) EthoLoop: Tracking and controlling animal behaviour in naturalistic environments
Daniel Huber, Ali Nourizonos

[T27-5B](#) Evaluation of the circadian expression of orexin receptors in the mouse brain by RNAscope®
Gina Marie Krause, Anne Albrecht

[T27-6B](#) Focal activation of the adenosine A₁ receptor in the brain through photopharmacology *in vivo*; a Proof of Concept
Jeroen Spanoghe, Lars Emil Larsen, Erine Craey, Simona Manzella, Kristl Vonck, Serge Van Calenbergh, Paul Boon, Robrecht Raedt

[T27-7B](#) GEXSCOPE: High throughput single cell solutions for transcriptomic analysis
Harlin Jhyont

[T27-8B](#) Imaging metabolic dynamics of neural cells by label-free wide-field FLIM
Werner Zuschratter, André Weber, Rodrigo Herrera-Molina, Ezgi Altun, Andrea Wetzel, Arthur Bikbaev, Alejandro Luarte

[T27-1C](#) Improving the efficiency of TEV protease for the genetic disruption of proteins and neural circuits in *Drosophila*
Jonas Peper, Burak Gür, Marion Silies

[T27-2C](#) Inferring network connectivity using modified Reservoir Computing
Pablo Rojas, Marie Kempkes, Martin E. Garcia

[T27-3C](#) Intracellular *in vivo* recording in the Mauthner neuron efficiently reveals effects of substance exposure on the mature vertebrate brain.
Peter Machnik, Elisabeth Schirmer, Benedikt Maric, Stefan Schuster

[T27-4C](#) PinkyCaMP: A Novel Red Shifted Genetically Encoded Calcium Indicator with mScarlet
Ryan Fink, Jana Ottens, Martin Kubitschke, Olivia Masseck

[T27-5C](#) PyView: A general purpose tool for analyzing calcium imaging data
C Giovanni Galizia, Georg Raiser, Ajayrama Kumaraswamy

[T27-6C](#) Targeting Noradrenergic Neurons of the Locus Coeruleus: A Comparison of Model Systems and Strategies
Chantal Wissing, Alexander Dieter, Maxime Maheu, Simon J. Wiegert

[T27-7C](#) The big, the fast and the blue: towards the optimal channelrhodopsin for the future optical cochlear

implant

Aida Garrido Charles, Theocharis Alvanos, Kathrin Kusch, Tobias Moser, Thomas Mager

[T27-8C](#) The Influence of Aldehyde Fixatives on Membrane Roughness as determined by Scanning Ion Conductance Microscopy

Marius Strachowitz, Dilan Yildiz, Heiko M. Lesslich, Irmgard D. Dietzel, Annika Haak

[T27-9C](#) Unusual electric properties in the skin of electric catfish.

Susanne Proschke, Georg Welzel, Stefan Schuster

A flexible and versatile system for multi-color fiber photometry and optogenetic manipulation

Andrey Formozov^{1,2}, Alexander Dieter^{1,2}, Simon Wiegert^{1,2}

¹Medical Faculty Mannheim - Heidelberg University, Neurophysiology, Ludolf-Krehl-Straße 13-17, 68167 Mannheim, Germany

²Center for Molecular Neurobiology Hamburg (ZMNH) - UKE, Synaptic Wiring and Information Processing, Falkenried 94, 20251 Hamburg, Germany

Fiber photometry is a technique of growing popularity in neuroscientific research. It is widely used to infer brain activity by recording calcium dynamics in genetically defined populations of neurons. Aside from the wide variety of calcium indicators, other genetically encoded biosensors have recently been engineered to measure membrane potential, neurotransmitter release, pH, or various cellular metabolites, such as ATP or cAMP. New optogenetic actuators for neuronal stimulation are also under constant development. Therefore, both photometry and optogenetic stimulation via the same device is highly desirable. However, for optical stimulation and read-out, or for the combination of multiple biosensors in one experiment different assemblies of optical hardware are needed. Such constraints often hamper a straightforward implementation of new molecular tools, evaluation of their performance *in vivo*, and design of new experimental paradigms – especially if the financial budget is a limiting factor. Here, we propose a novel approach for fiber photometry recordings, based on a multimode optical fused-fiber coupler for both light delivery and collection. Recordings can readily be combined with optogenetic manipulations in a single device without the requirement for dichroic beam-splitters. In combination with a multi-color light source and appropriate emission filters, our approach offers remarkable flexibility in experimental design and facilitates the implication of new molecular tools *in vivo* at minimal cost. We readily configured the setup to operate with green, red and near-infrared calcium indicators and demonstrate the capability of simultaneous optogenetic stimulation. We further show the multi-color photometry capabilities of the system. The ease of assembly, operation, characterization, and customization of this platform holds the potential to foster the development of experimental strategies for multi-color fused fiber photometry combined with optogenetics far beyond its current state.

Fused Fiber Photometry (FFP)

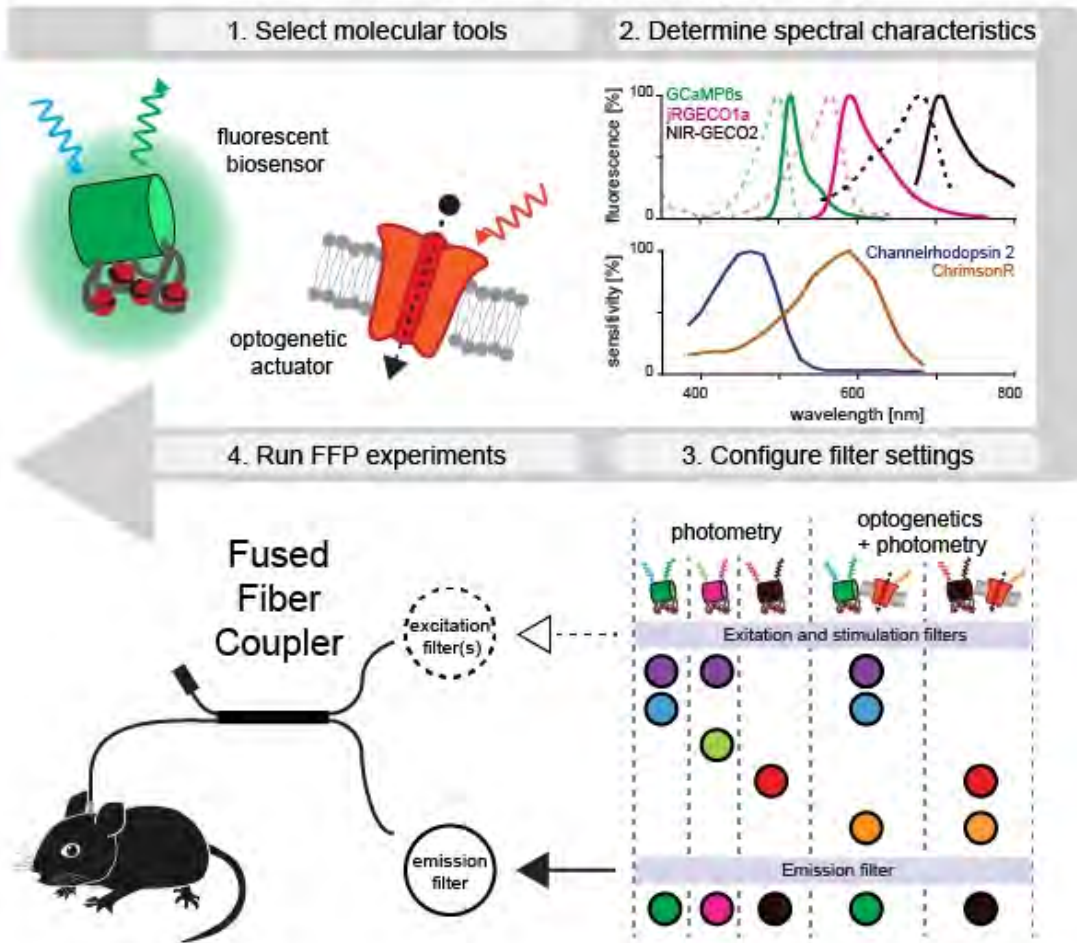

Fused Fiber Photometry (FFP) enables straightforward monitoring and manipulation of brain activity, supporting indicators and actuators with virtually any spectral characteristics

A web portal facilitating FAIRification of research data in neuroscience

Robert Kossen¹, Luca Freckmann¹, Christian Henke¹, Linus Weber¹, Ulrich Sax¹, Sara Y. Nussbeck^{1,2}, Harald Kusch^{1,3}

¹Department of Medical Informatics, University Medical Center Göttingen (UMG), Göttingen, Germany

²Central Biobank UMG, UMG, Göttingen, Germany

³Cluster of Excellence “Multiscale Bioimaging: from Molecular Machines to Networks of Excitable Cells” (MBExC), University of Göttingen, Göttingen, Germany

Research in neuroscience generates and deals with a wide array of different data types, metadata, and methodologies. Depending on the disciplines and research questions, these can include antibodies, model organisms, or genetic sequencing data. This diversity results in a strong need for documentation, standardization, storage, and metadata annotation of datasets, especially in the context of collaborative projects or research consortia.

The Department of Medical Informatics at the University Medical Center Göttingen aims to enable, facilitate, and foster the exchange and FAIRification (**F**indable, **A**ccessible, **I**nteroperable, **R**e producible) of research data and metadata in the life sciences through the development, implementation, and support of a modular, web-based research data platform (RDP).

The RDP has been deployed for eight research consortia and different components can be enabled depending on the requirements and scope of the research projects and the involved methodologies or materials. A core part of the RDP is the in house developed, open-source data management portal *menoci* [1,2]. The Drupal-based *menoci* web tool allows for standardized documentation, sharing, and cross-referencing of different data types, workflows, and scientific publications. Different modules have been implemented for specific data types and workflows, such as antibodies or specific model organisms, allowing for the enrichment of entries with specific metadata and linking to further relevant entries in different modules.

menoci is complemented by additional specific applications, allowing for appropriate documentation, storage, and annotation of certain, specialized data types. Larger and more systemic data, such as OMICS datasets, can be managed, shared, and cross-linked via an implementation of the FAIRDOME SEEK platform [3], while microscopy datasets can be organized, shared, and even analyzed using the OMERO web platform [4].

Development of the *menoci* portal, as well as the selection and implementation of further tools, such as FAIRDOME SEEK and OMERO, was driven by close communication with researchers as early adopters and experts. Requirements analysis and concept development involved in person observation of experimental procedures, interviews, and collaboration with researchers and experts, as well as the investigation of available and applicable metadata standards and tools. Both the initial and continued development, as well as the implementation and support, follow an agile strategy, and as such feedback from existing users and further interested researchers and consortia is collected and reviewed to steer continuous improvement, development, and potential expansion of the RDP.

As a specific example, the Multiscale Bioimaging Cluster of Excellence (MBExC) RDP facilitates sharing of MBExC data and is available at <https://mbexc.uni-goettingen.de/>. MBExC aims at international visibility and broad use of its generated data. It develops and adapts appropriate data sharing tools in a bottom up FAIRification process. To this end, the MBExC RDP currently holds metadata and supplemental data associated with 600 MBExC-derived publications.

References

[1] <https://menoci.io>

[2] Suhr M, Lehmann C, Bauer CR, Bender T, Knopp C, Freckmann L, et al. *menoci*: Lightweight Extensible Web Portal enabling FAIR Data Management for Biomedical Research Projects. Feb 2020, doi:10.1186/s12859-020-03928-1

[3] <https://seek4science.org>

[4] <https://www.openmicroscopy.org/omero/>

Acousto-optic voltage imaging in awake mice with JEDI-2P

Denes Palfi¹, Balazs Chiovini¹, Viktoria Kiss¹, Zsolt Mezriczky¹, Anna Mihaly¹, Katalin Ocsai¹, Balazs J. Rozsa¹

¹Pazmany Peter Catholic University, Faculty of Information Technology and Bionics, 59 Prater str., 1083 Budapest, Hungary

Functional two-photon imaging is a valuable tool for following the activity of neurons in vivo in the brain, through multiple cortical layers. This technique provides high spatial resolution, but its temporal resolution is insufficient to resolve real-time changes in neuronal activity. On the other hand, electrophysiological recordings provide high temporal resolution only in a few chosen locations in the brain.

To understand the direct communication among neurons, measuring changes in their membrane potential is necessary. Calcium imaging is currently a popular technique; however, it is an indirect tool of detecting these changes.

Voltage indicators, which are fast, dynamic, and direct tools for monitoring neuronal activity, are quite new in the field of functional two-photon imaging and could combine the benefits of this technology with those of electrophysiology. The fast voltage indicator JEDI-2P is an excellent candidate for achieving this goal. Combining fast acousto-optic imaging with modern voltage indicators allows us to monitor the activity of dozens of cells even on the dendritic level.

Here, I present different applications which demonstrate the power of direct imaging of action potentials. We have performed in vitro and in vivo 3D measurements from multiple cells with an up to 50 kHz temporal resolution, by using novel acousto-optic scanning techniques and the JEDI-2P indicator. With this ultra-high temporal resolution, even subthreshold signals can be followed during dendritic processes. In summary, these novel tools can revolutionize our knowledge of neuronal computation.

Automated Patch Clamp and CryoEM Team up for Mode of Action Elucidation of Two *D. melanogaster* Slo Modulators

Andreas Brockmann¹

¹Bayer CropScience, Alfred-Nobel Straße 50, 40789 Monheim am Rhein, Germany

Slo is a voltage and Ca²⁺ activated potassium channel, involved in the regulation of neuronal excitability. Chemical modulation of Slo induce severe effects, like tremors and paralysis, introducing Slo as an interesting insecticidal target.

In this work we are focusing on the electrophysiological behavior of two Slo modulators, emodepside (agonist, anthelmimetic drug in Animal Health) and verruculogen (antagonist, known as tremorgenic mycotoxin) as well as their interaction with each other. CryoEM structures support our data and explain the unique mode of action of emodepside. Furthermore, these findings might enhance a structure guided synthesis of new crop protection products.

Bayesian Oracle for bounding information gain in neural encoding models

Konstantin-Klemens Lurz¹, Mohammad Bashiri¹, Fabian Sinz²

¹University of Tübingen, Computer Science, Maria-von-Linden Str. 6, 72076 Tübingen, Germany

¹University of Göttingen, Computer Science, Goldschmidt Str. 1, 37075 Göttingen, Germany

In recent years, deep learning models have set new standards in predicting neural population responses. Most of these models currently focus on predicting the mean response of each neuron for a given input. However, neural variability around this mean is not just noise and plays a central role in several theories on neural computation. To capture this variability, we need models that predict full response distributions for a given stimulus. However, to measure the quality of such models, commonly used correlation-based metrics are not sufficient as they mainly care about the mean of the response distribution.

An interpretable alternative evaluation metric for likelihood-based models is Information Gain (IG) which evaluates the likelihood of a model relative to a lower and upper bound. However, while a lower bound is usually easy to obtain, constructing an upper bound turns out to be challenging for neural recordings with relatively low numbers of repeated trials, high (shared) variability, and sparse responses. In this work, we generalize the jack-knife oracle estimator for the mean---commonly used for correlation metrics---to a flexible Bayesian oracle estimator for IG based on posterior predictive distributions.

We describe and address the challenges that arise when estimating the lower and upper bounds from small datasets. We then show that our upper bound estimate is data-efficient and robust even in the case of sparse responses and low signal-to-noise ratio. We further provide the derivation of the upper bound estimator for a variety of common distributions including the state-of-the-art zero-inflated mixture models, and relate IG to common mean-based metrics. Finally, we use our approach to evaluate such a mixture model resulting in 90% IG performance.

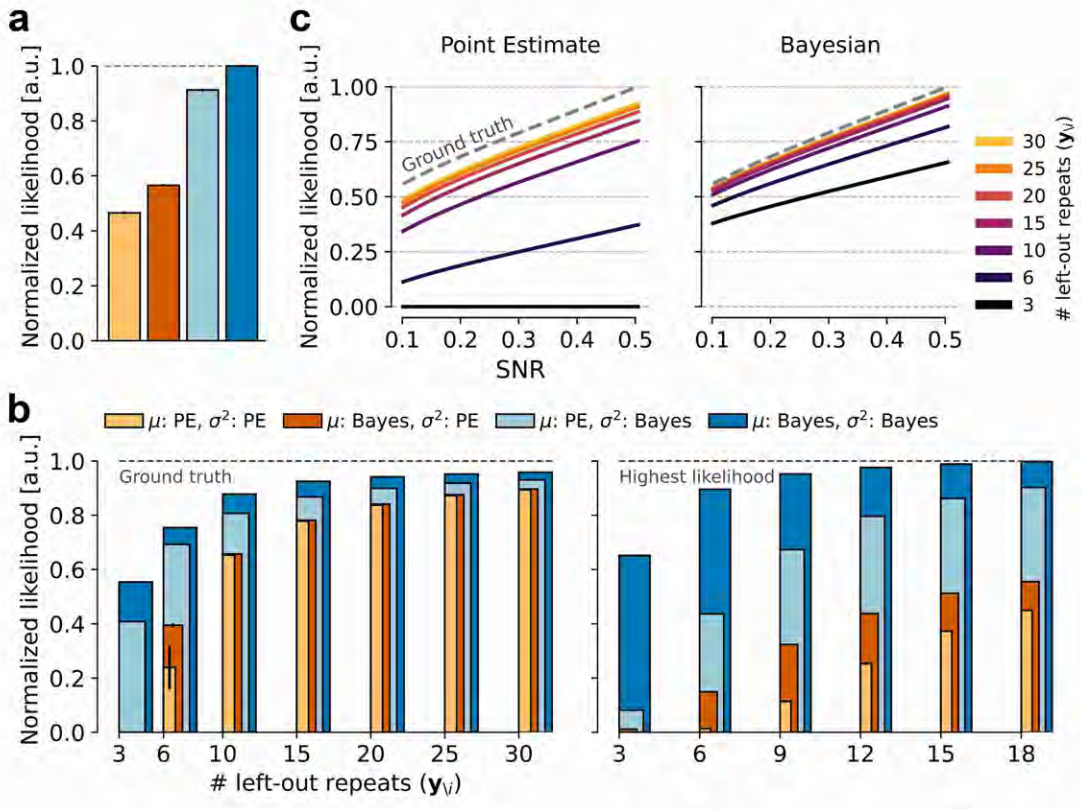

Channelrhodopsin library screening by automated planar patch-clamp recordings facilitates the development of the future optical cochlear implant

Alexey Alekseev^{1,2}, Maria Zerche^{1,2,3}, Tobias Moser^{1,4,5,6}, Thomas Mager^{1,2,4}

¹Institute for Auditory Neuroscience and InnerEarLab, University Medical Center Göttingen, Göttingen, Germany

²Advanced Optogenes Group, Institute for Auditory Neuroscience, University Medical Center Göttingen, Germany

³Department of Otolaryngology, University Medical Center Göttingen, Göttingen, Germany

⁴Cluster of Excellence "Multiscale Bioimaging: from Molecular Machines to Networks of Excitable Cells" (MBExC), University of Göttingen, Göttingen, Germany

⁵Auditory Neuroscience and Optogenetics Laboratory, German Primate Center, Göttingen, Germany

⁶Auditory Neuroscience and Synaptic Nanophysiology Group, Max Planck Institute for Multidisciplinary Science, Göttingen, Germany

Introduction

To date, electrical cochlear implants (eCI) partially restore hearing in ~700.000 otherwise deaf users. However, the frequency resolution of eCIs is limited due to the current spread at its electrode contacts and the tonotopic organization of the cochlear. As light can be more precisely confined in space, the optical cochlear implant (oCI) promises a better frequency resolution and consequently closer to natural hearing for the deaf. The oCI relies on light-gated ion channels, so called Channelrhodopsins (ChRs). Ideally, ChRs employed in the future oCI will exhibit a high plasma membrane expression, fast channel kinetics, a red-shifted action spectrum, and a high single channel conductance.

We aim to obtain advanced ChRs, combining the aforementioned favorable properties, by extensive screening of natural and semi-rationally designed ChR variants. Patch-clamp electrophysiology is the gold standard for the characterization of ion channels in biological membranes. The drawback of the technique usually is its low throughput, which rules out extensive screenings. Automated planar patch-clamp devices, which are not widely used in photobiology so far, however, enable data collection with considerably higher throughput. We accordingly employ an automated planar patch-clamp system equipped with suitable illumination devices, for the design of a red-light activated, fast, and big photocurrent ChR, suitable for the future oCI.

Results

We optimized protocols for ChR library screenings on the Opto-Syncropatch platform, which allows simultaneous recordings from up to 384 cells. We show that our method enables the characterization of up to 12 ChR variants with double digit N-numbers by using just one 384-well chip.

Moreover, we demonstrate that Opto-Syncropatch recordings are not restricted to screening purposes. They are also beneficial when massive amounts of data are needed to obtain a reliable value. One fundamental property of any ion channel is its single channel conductance. The single channel conductance of ChRs is very small and can therefore only be derived by noise analysis. Following conventional approaches, data collection for noise analysis is very time consuming. We present a procedure for ChR single channel conductance determination by noise analysis using no more than two chips per variant, thereby reducing the

time for data acquisition by several order of magnitudes.

Conclusions

We present optimized workflows, based on an automated planar patch-clamp system, equipped with suitable illumination devices, for ChR library screenings and for the in-depth characterization of selected ChRs. Thereby, our focus is on engineering a suitable ChR for the future oCI. The opto-Syncropatch recordings will moreover yield large databases of ChRs properties, which will enable advanced data analysis and will likely boost optogenetic tool development.

Characterization of mouse enteroendocrine cell subtypes

Matea Krizman¹, Benjamin H. Cooper^{1,3}, Cordelia Imig^{2,3}

¹Max Planck Institute for Multidisciplinary Sciences, Department of Molecular Neurobiology, Hermann-Rein-Str. 3, 37075 Göttingen, Germany

²University of Copenhagen, Faculty of Health and Medical Sciences, Department of Neuroscience, Blegdamsvej 3B, 2200 Copenhagen, Denmark

³These authors contributed equally

Enteroendocrine cells (EECs) are sensory epithelial cells of the gastrointestinal (GI) tract that sense the external milieu of the gut lumen and communicate changes to neurons of the enteric nervous system and those signalling to the brain, thereby regulating food intake and metabolism. Individual EECs are found scattered at very low spatial density throughout the gut epithelium, but they form together the largest endocrine organ of our body. Together, EECs comprise a heterogeneous group of endocrine cells that differ with respect to the types of peptide hormones (e.g. CCK, SST, GIP, GLP-1) and neurotransmitters (e.g. serotonin, glutamate) they express. Given this complexity, genetic strategies to target specific EEC subpopulations are a prerequisite to accurately dissect the structural, functional, and molecular properties of individual EECs in different regions of the gut. To facilitate this endeavour, several transgenic reporter mouse lines have been generated and characterised – mainly in the context of gene expression studies. Despite these technical advances, the question of how different EEC types store and release hormones and neurotransmitters remains unanswered. Moreover, a detailed cell type-specific characterization of EEC ultrastructure detailing the subcellular organization of their secretory organelles (i.e. vesicle pools) and subcompartments (i.e. hormone release sites) is lacking. To address these questions, we present here a methodological workflow combining mouse genetics to express fluorescent reporters allowing visualization of specific enteroendocrine cell subtypes, primary cultures of the mouse gut epithelium, and correlative light- and electron microscopy (CLEM) and immuno-EM approaches. The ultimate goal of this study is to generate a detailed, subclass-specific morphological atlas of EEC cell ultrastructure of different subtypes and from different regions of the gut.

Development of an optogenetic dimerization tool to control mitochondrial movement

Juliana Groß¹, Olivia A. Masseck¹

¹University of Bremen, Synthetic Biology, Leobener Straße 5, 28359 Bremen, Germany

Next to their role as primary source of energy, mitochondria hold vital roles for maintaining cellular health. Mitochondrial function and homeostasis are implicated in various intracellular processes, such as calcium buffering. The transport of mitochondria along the cytoskeleton has become subject of many studies investigating molecular causes of neuronal and neurodegenerative diseases. Aberrant mitochondrial transportation was often found to be involved in the pathogenesis of these diseases. Yet, basic understanding of the molecular events and involved proteins in such pathological conditions is still lacking and hinders the development of molecular treatment approaches. The use of optogenetic dimerization tools displays a low-invasive, molecular technique with high spatio-temporal resolution to study and control mitochondrial transport. Eventually, these tools could be refined to serve as molecular treatment strategy in rescuing mitochondrial transport-related pathological phenotypes.

The purpose of the current project was to start the development of such a light-inducible dimerization tool to manipulate mitochondrial movement. More precisely, to either stop or move mitochondria. Further, the project aimed in setting up the technical conditions in the lab of Olivia Masseck required for researching with this kind of tool. From the toolbox of optogenetic dimerizers, the photosensory domains of the blue light-inducible dimerizer tool „eMag“ were chosen as a scaffold for the tool „MitoMag“, developed in this project.

Successful reproduction of eMag-dimerization could show the suitability of the available setup, consisting of a widefield fluorescence microscope and a Polygon pattern illuminator, to work with this kind of optogenetic dimerizer. Appropriate hardware settings and operational considerations for image acquisition and analysis were delivered and can be used as a guideline for future projects working on MitoMag. Two variants of MitoMag, MitoMag-Stop and MitoMag-Move, were generated with and without flexible linkers separating the photosensory eMag-domains from the other domains of MitoMag. The outer membrane protein OM64 was approached for the mitochondria-targeted tool component (called MitoBase). The protein targeted for stopping mitochondrial movement was FHL2, while a truncated version of the kinesin KIF1A was targeted for inducing mitochondrial movement. Mitochondrial movement could not be manipulated with neither the MitoMag-Stop, nor the MitoMag-Move tool variant. Yet, changes in mitochondrial morphology were observed for MitoBase lacking a flexible linker which were abolished for MitoBase including a flexible linker. This points to a critical role of flexible linkers in the genetic design of MitoMag. It is further suggested that flexible linkers separating the photosensory-domains from FHL2 and KIF1A are necessary to preserve their role as anchor and motor protein of MitoMag.

In sum, this project determined important insights into decisive factors for the further development of MitoMag and established the technical prerequisites for applying such an optogenetic dimerization tool.

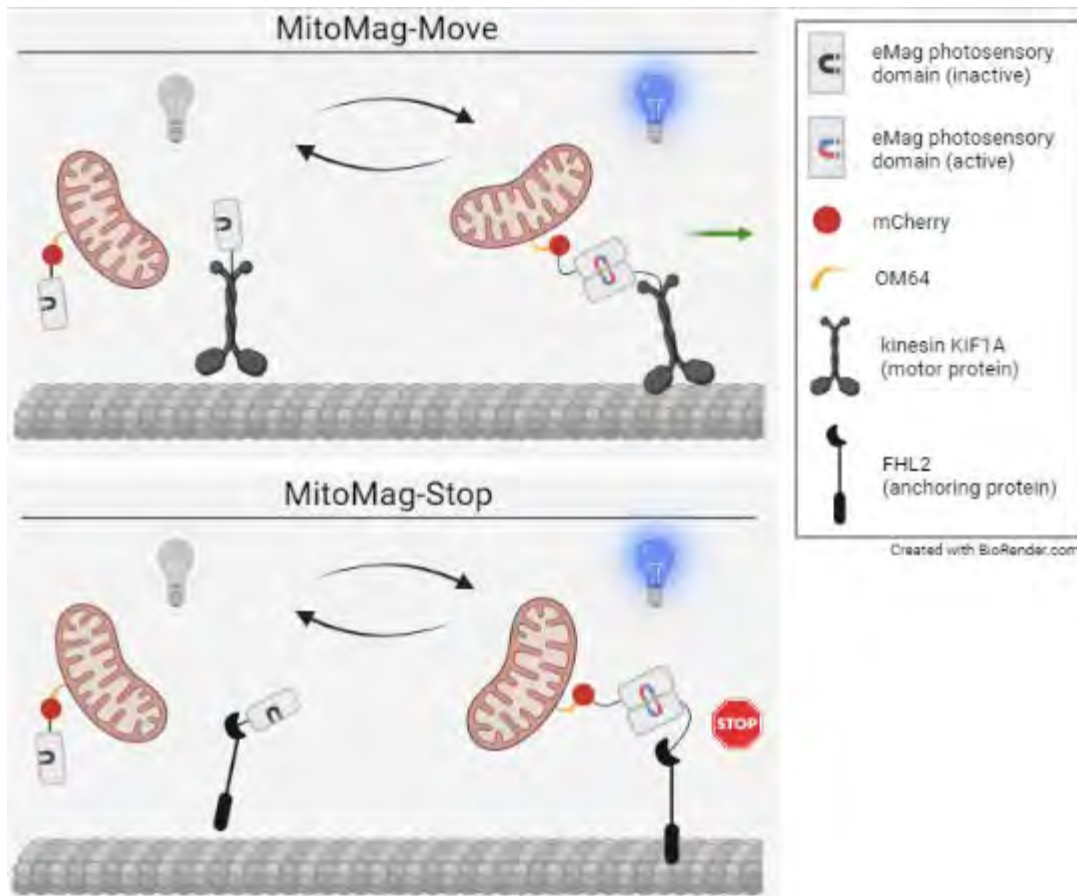

Schematic representation of the operating principle of the MitoMag tool to control mitochondrial movement.

Dissecting local changes in the coding and non-coding neuronal transcriptome revealed by subcellular transcriptomics

Jennifer Heck^{1,2}, Valeriy Pak¹, Aliaksandr Halavatyi³, Arif Ul Maula Khan³, Kyung-Min Noh², Sinem K. Saka¹

¹European Molecular Biology Laboratory (EMBL), Spatial biology from molecules to tissues: high-dimensional investigation of cellular organisation, Genome Biology Unit, Heidelberg, Germany

²European Molecular Biology Laboratory (EMBL), Epigenetic mechanisms of neurodevelopment and diseases, Genome Biology Unit, Heidelberg, Germany

³European Molecular Biology Laboratory (EMBL), Advanced Light Microscopy Facility, Heidelberg, Germany

Neurons rank among the most highly polarized cell types, characterized by structurally and functionally distinct processes, axons and dendrites, that built the fundamental network of the nervous system. This complex morphology goes hand in hand with the need for a spatio-temporal control of a wide variety of cellular processes far away from the cell body. Notably, many neuronal disorders are initiated by changes occurring rather distant from soma, particularly in axons (axopathologies) and synapses (synaptopathies). It is now well accepted that synapses, which represent the smallest interfaces of information transfer, are capable to independently respond to internal and external triggers, the basis of synaptic plasticity. One prerequisite of synaptic autonomy is the local translation of proteins enabled by the presence of the protein translation machinery including a distinct pool of RNA transcripts. Indeed, the spatial distribution of the transcriptome, RNA trafficking and life time have been proven to be powerful mechanisms to regulate the synaptic proteome composition and might therefore have crucial implications for neuropathologies. The development of strategies to isolate axonal or synaptic material and recent progress in highly multiplexed RNA profiling techniques in single cells have generated valuable insights into transcript enrichments in neuronal compartments. However, the size and morphology of these compartments make it difficult to study their comprehensive molecular make up within spatial and functional context.

In this project we adopt a novel spatial transcriptomic method, called Light-Seq (Kishi et al. 2022) which allows to preserve spatial information and morphology by an in-situ indexing strategy using light-directed DNA barcoding in fixed cells and tissues followed by comprehensive ex situ sequencing. Light-Seq provides the sensitivity to sequence rather small custom-selected subsets of cultured cells or rare cell types in tissue by optical pooling (with <30 cells per group) and is therefore ideally suited to access local changes in the coding and non-coding transcriptome of neuronal subtypes. To establish the subcellular application of Light-Seq we are using mouse primary neuron cultures in an adaptive feedback microscopy pipeline to segment neuronal compartments including soma, dendrite, axon, down to diffraction-limited nano-compartments like synapses for light-directed DNA barcoding. Combined with next-generation sequencing readout we aim to map compositional changes in the coding and non-coding transcriptome upon neuronal network stimulations to ultimately link the regulation of RNA pools to neuronal physiology and pathology.

Dual color imaging in freely-behaving rodents using head-mountable one photon miniscope

Norbert Hogrefe¹, Srishti Gulati², Kevin Zitelli², Douglas Ollerenshaw², Alice Stamatakis²

¹Inscopix, Inc., Field Scientific Consultant Team, Mountain View, CA, USA

²Inscopix, Inc., Science R&D - Product & Applications, Mountain View, CA, USA

We have developed a miniscope system that enables dual color imaging in freely-behaving rodents, thus greatly expanding the current range of in vivo imaging applications. The nVue™ system enables numerous applications, including simultaneous imaging of Ca²⁺ activity in two distinct cell populations, imaging Ca²⁺ activity with static markers identifying neurons based on projection, activity, or genetics and imaging Ca²⁺ activity alongside neurotransmitter release or blood flow.

To enable dual color imaging, we have integrated two separate LEDs to image green and red indicators without optical and biological crosstalk. These LEDs are multiplexed rapidly during imaging, enabling simultaneous visualization of green and red fluorescent signals. To correct for chromatic shifts in green and red focal planes, we have developed novel GRIN lenses that minimize axial chromatic aberrations. Furthermore, we use electronic focusing capabilities of our miniscope to automatically correct for residual color aberration.

Here, we present in vivo applications to demonstrate use cases of the nVue system. To demonstrate static + dynamic imaging, we imaged mPFC neurons expressing GCaMP6m and contralaterally-projecting neurons labeled with TdTomato. Dual dynamic imaging is demonstrated by imaging in the dorsal striatum the release of dopamine, using RDA1m, alongside neuronal activity, using GCaMP6m. For demonstration of blood flow imaging, microcirculation, using a rhodamine-dextran dye, is recorded with simultaneous neuronal activity, using GCaMP. These applications demonstrate the utility of the nVue system for exploring the intricacies of how two distinct brain signals interact during free behavior, enabling deeper insights into central nervous system functions.

Effects of 24h of 2g-hypergravity on mouse blood brain barrier

David Dubayle¹, Jean-Luc Morel²

¹CNRS, INCC UMR 8002 - Université Paris Cité, 75006 Paris, France

²CNRS, INCIA UMR 5287 - Université de Bordeaux, 33000 Bordeaux, France

Modifications of gravity levels induce generalized adaptation of mammalian physiology including vascular, brain, muscle, bone and immunity functions through stimulation and dysregulation of the vestibular system. Cellular approaches also indicated that cytoskeleton is particularly affected by gravity changes suggesting that gravity force is detected at cellular level. Neurovascular unit is known to be stimulated by modification of pressure. Then we hypothesize that the blood brain barrier (BBB) is modified by hypergravity.

The hypergravity is produced by 24h exposure to 2g-centrifugation. As classically demonstrated by IgG extravasation, this hypergravity exposure is sufficient to induce the BBB leakage. In order to characterize the “opening size” of BBB, we have performed i.v. injection of FITC-dextran with different sizes (40, 70, 150 kDa). We finally injected antisense oligonucleotides (FAM-ASON directed against Angpt2; 7kDa) to show if the injected molecules can be captured by the cells forming the neurovascular unit. The analyses were realized by microscopy (Nanozoomer and confocal microscopy) to localize the presence of fluorescent molecules in the parenchyma of different brain structures. We verify the ability of FAM-ASON to be captured in liver as positive control. At the end, we analyse by RTqPCR the modification of expression of several genes encoding proteins implicated in endothelial cell junction and cytoskeletal dynamics.

Taken together, our results suggest that the hypergravity modifies the endothelial cell junctions via gene expression. Secondly, the size and also the nature of the molecules influence their spreading through the BBB in hypergravity context. Our experiences should be consolidated to validate centrifugation as a non-invasive approach (i.v. administration) to increase delivery of pharmacological drug into the brain.

EthoLoop: Tracking and controlling animal behaviour in naturalistic environments

Daniel Huber¹, Ali Nourizonos¹

¹University of Geneva, Department of Basic Neurosciences, Rue Michel Servet 1, CH-1206 Geneva, Switzerland

Accurate tracking and analysis of animal behavior is crucial for modern systems neuroscience. Animals can be easily monitored in confined, well-lit spaces or virtual-reality setups. However, tracking freely moving behavior through naturalistic, three-dimensional environments remains a particular challenge in primates. Closed-loop control providing behavior-triggered stimuli, is also more complicated in free-range settings. Here, we present EthoLoop (www.etholoop.org): a framework for studying the neuroethology of freely roaming primates.

Combining real-time optical tracking, “on-the-fly” behavioral analysis with remote-controlled stimulus-reward boxes, allows us to directly interact with free-ranging mouse lemurs in their habitat. We show that this closed-loop optical tracking system can be used to follow the 3D spatial position of multiple subjects in real time, continuously provide close-up views, and condition behavioral patterns detected online with deep learning methods. Reward or stimulus feedback is provided by battery-powered and remote-controlled devices that communicate with the tracking system and can be positioned at multiple locations in the environment.

Using the EthoLoop system in combination with wireless recording techniques, we were not only able to reveal the first 3D place cells in primates, but also demonstrate that complex behaviors, such as jumping from branch to branch, can be studied in a quantitative and highly reproducible manner. Taken together, the EthoLoop framework enables a new generation of interactive, but well-controlled and reproducible neuroethological studies with primates in large-field naturalistic settings.

Evaluation of the circadian expression of orexin receptors in the mouse brain by RNAscope®

Gina Marie Krause¹, Anne Albrecht^{1,2}

¹Otto-von-Guericke Universität Magdeburg, Institut für Anatomie, Abteilung Neuroanatomie, Leipziger Str. 44, 39120 Magdeburg, Germany

²Center for Behavioural Brain Science (CBBC), Universitätsplatz 2, 39106 Magdeburg, Germany

Orexin A and B are wake-promoting neuropeptides that originate from a subgroup of hypothalamic neurons projecting to diverse brain areas widespread throughout the central nervous system. There, they modulate various physiological functions via orexin 1 (OXR1) and 2 (OXR2) receptors, including the sleep-wake rhythm but also cognitive functions. It has been shown in multiple species that the expression level of orexins varies over the course of a day, peaking during the respective active awake phase of subjects.

To investigate now whether orexin receptors show circadian and region-specific expression differences likewise the neuropeptide, a novel multiplex in situ hybridization technique called RNAscope® was used. OXR1 and OXR2 mRNA expression was analyzed in subareas of the dorsal hippocampus and medial prefrontal cortex at four equidistant time points over the course of 24 hours. The percentage of orexin receptor mRNA-expressing cells was constant over time within brain areas, but significant expression differences between brain regions and subareas were evident. The highest percentage of OXR1 mRNA-positive cells was observed in the hilus of the dentate gyrus and the stratum pyramidale of the CA3 region, while the highest percentage of OXR2 mRNA-positive cells was seen in the stratum pyramidale of the CA1 and CA3 regions of the dorsal hippocampus. The expression of both receptor subtypes was lower in subareas of the PFC. Quantitative analysis of OXR1 mRNA expression in the hilus hints towards a time of the day-dependent modulation of mRNA levels in OXR1-positive cells.

Detecting orexin receptor mRNA expression with RNAscope® provides high selectivity and great spatial resolution. The distinct expression profiles of both receptor subtypes within hippocampal subareas provide an interesting basis for future interventional studies of orexin receptor function in spatial and emotional memory.

Focal activation of the adenosine A₁ receptor in the brain through photopharmacology *in vivo*; a Proof of Concept

Jeroen Spanoghe¹, Lars Emil Larsen¹, Erine Craey¹, Simona Manzella¹, Kristl Vonck¹, Serge Van Calenbergh², Paul Boon¹, Robrecht Raedt¹

¹Brain, Department of Head and Skin, Ghent University, Belgium

²Laboratory for Medicinal Chemistry, Department of Pharmaceutics, Ghent University, Belgium

Aim: A significant proportion of epilepsy patients suffers from drug-resistant epilepsy (DRE), marking an important need for innovative therapies to treat this disorder. In this regard, the adenosine system has garnered a lot of interest. Adenosine acts as an endogenous anticonvulsant and seizure terminator in the brain, mediated by activation of the inhibitory adenosine A₁ receptors (A₁R). While previous studies have shown that administration of A₁R agonists can be an effective treatment in DRE models, clinical application of these agonists is hindered by severe systemic side effects. With photopharmacology, a technique which provides high spatiotemporal control over the activity of a drug with light, local A₁R activation can be achieved and side-effects can be avoided. In this research, the use of photocaged cyclopentyladenosine (pcCPA; an inactivated A₁R agonist) is being tested for the first time *in vivo* with the goal of obtaining controlled suppression of seizure activity in a DRE mouse model.

Methods: The possibility to optically uncage pcCPA in the brain of mice was first studied by investigating effects on hippocampal electrophysiology. Acute recordings of perforant path evoked potentials (EPs) were performed in healthy mice under anesthesia, before and after intracerebroventricular (ICV) administration of pcCPA. Animals were implanted with an optrode in the dentate gyrus to deliver light pulses ($\lambda = 405$ nm). Effects on EPs after illumination were compared to those of ICV administration of the parent compound CPA.

To test the effect of local pcCPA uncaging on hippocampal seizures, mice were implanted with a cannula above the lateral ventricle and an optrode in the hippocampus 3 weeks after intrahippocampal injection of kainic acid. After baseline EEG recording, ICV administration of pcCPA was performed through the cannula and light was delivered via the optrode. The frequency of occurrence of seizures was compared before and after the intervention.

Results: Local illumination in the hippocampus after ICV administration of pcCPA resulted in clear suppression of dentate gyrus EPs, similar to those obtained with ICV administration of CPA, indicating successful activation of inhibitory A₁Rs.

In a pilot study with epileptic mice, ICV administration of pcCPA combined with hippocampal illumination temporarily suppressed the occurrence of spontaneous seizures.

Conclusion: In this proof of concept study, it has been demonstrated that local and temporal activation of A₁Rs can be achieved *in vivo* in the hippocampus of mice by using photopharmacology. Furthermore, the first results with pcCPA in epileptic mice show that this photopharmacological approach could be effective in suppressing seizures in a model for temporal lobe epilepsy.

GEXSCOPE: High throughput single cell solutions for transcriptomic analysis

Harlin Jhyont¹

¹Singleron Biotechnologies, Singleron Biotechnologies, Gottfried-Hagen-Straße 60, 51105 Köln, Germany

Recently, single cell transcriptome sequencing technology has rapidly developed to provide an effective method for researchers to study the heterogeneity of cells; understand molecular mechanisms and developmental processes; and investigate different disease states at a single cell resolution. The growing interest to conduct research at a single cell level has led to rapid technological advances in single-cell sequencing methods to evolve from low to high cell throughput and progression from single cell transcriptomics to single cell multi-omics. Further advancements have led to adapting cutting-edge GEXSCOPE® microwell-based technology, allowing single cell analysis research to be conducted at a high throughput rate of up to 30,000 cells per sample without the necessity to use specialized instruments. Singleron GEXSCOPE® kits are tailored to measure gene expression in single cells, single nuclei and yeast cells, offering a single cell platform highly suitable for clinical applications to address questions in multiple research fields including cancer research, immunology, neuroscience or developmental biology.

Imaging metabolic dynamics of neural cells by label-free wide-field FLIM

Werner Zuschratter¹, André Weber¹, Rodrigo Herrera-Molina^{1,6}, Ezgi Altun¹, Andrea Wetzel⁷, Arthur Bikbaev⁵, Alejandro Luarte^{2,3,4}

¹Leibniz Institute for Neurobiology, Combinatorial NeuroImaging Core Facility, Brenneckestr. 6, 39118 Magdeburg, Germany

²Biomedical Neuroscience Institute, Faculty of Medicine, Universidad de Chile, Santiago, Chile

³Centro de Investigación Clínica Avanzada, Facultad de Medicina and Hospital Clínico, Universidad de Chile, Santiago, Chile

⁴Departamento de Neurociencias, Facultad de Medicina, Universidad de Chile, Santiago, Chile

⁵Functional Neurobiology, Johannes Gutenberg-University Mainz, Institute for Developmental Biology and Neurobiology, Mainz, Germany

⁶Centro Integrativo de Biología y Química Aplicada, Universidad Bernardo O'Higgins, 8307993, Santiago, Chile

⁷Institute of Medical Psychology, Otto von Guericke University, Leipziger Strasse 44, 39120 Magdeburg, Germany

We describe an imaging method that is able to follow small metabolic changes in the activity of cells and tissues of the CNS over long periods of time under physiological conditions without invasive staining procedures.

Fluorescence lifetime imaging microscopy (FLIM) enables the determination of energy-related redox and protein-bound states without labeling by analyzing the fluorescence behavior of metabolically relevant molecules such as NAD(P)H and FAD. In addition to the intensity, the fluorescence lifetime of these intrinsic metabolites provides important information about the composition and conformation of molecules, which can be used to monitor activity- or pharmacologically-induced changes in neuronal cell cultures.

Observing such small changes in active cells is extremely challenging due to the low quantum yield of these metabolic molecules. Furthermore, correct FLIM measurements require robust statistics based on a sufficient number of photons collected. For this reason, a reliable FLIM system must meet the following criteria: (1) high sensitivity, (2) high signal-to-noise ratio, (3) temporal resolution in picoseconds, and (4) a detection range equivalent to the entire field of view.

Here we present a novel wide-field FLIM method for NAD(P)H/FAD molecule detection using an innovative, commercially available camera system (LINCcam, Photonscore GmbH, Germany) based on time-correlated single photon counting (TCSPC). The camera features a uniquely high signal-to-noise ratio, high temporal resolution (< 50 ps) and operation under extremely low light conditions (< 30mW/cm² on average). It thus allows long-term observation of NADH without causing cell damage.

We show that the LINCcam-based FLIM system is capable of measuring changes in metabolic activity in neuronal cell cultures in combination with electrophysiological stimulation. The experiments reveal a close correlation between the neuronal activity and the dynamic changes of the observed metabolites.

We show that the high sensitivity of the LINCcam enables large spatial scalability and high temporal resolution to examine retinal cells under normal and pathophysiological conditions and to resolve fluctuations in the molecular states of NAD(P)H/FAD during single-neuron imaging. The recorded live cell data can be merged with images from immunostained samples after fixation to further characterize the subcellular source of the measured metabolic activity.

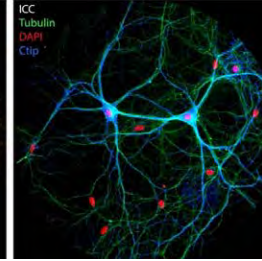
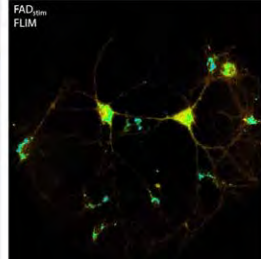
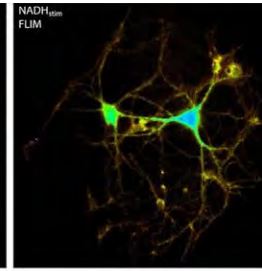
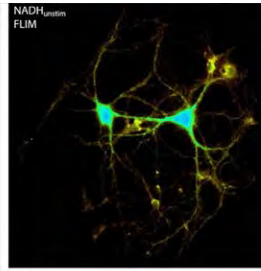

Improving the efficiency of TEV protease for the genetic disruption of proteins and neural circuits in *Drosophila*

Jonas Peper¹, Burak Gür¹, Marion Silies¹

¹Institute of Developmental Biology and Neurobiology (iDN), Johannes-Gutenberg-Universität Mainz, Neural Circuits lab, Hanns-Dieter-Hüsch-Weg 15, 55128 Mainz, Germany

Every neuron synthesizes a specific set of proteins that shape synaptic communication enabling diverse computations. Understanding how specific proteins, such as neurotransmitters receptors, determine intrinsic and synaptic processes is crucial for elucidating the function of neuronal circuits. To manipulate proteins in specific cells and across specific synaptic connections, we aim to cut essential synaptic proteins at and across synapses by using an extracellular TEV protease (TEVp). TEVp is a widely used biotechnological tool, cutting precisely a seven amino acid TEV cleavage site. This short cleavage sequence can be engineered into native proteins, allowing a precise inactivation of any protein of interest.

For proteolytic cleavage, we generated membrane bound, extracellular TEVp fusion proteins for expression at either in pre- or in post-synaptic sites. We validated the functionality of extracellular TEVp in vitro, but in vivo tests with the wildtype TEVp showed insufficient cleavage. We thus set out to improve TEVp in *Drosophila* by targeting both, TEVp stability and its activity. We generated novel TEVp variants by introducing mutations preventing posttranslational modifications such as N-glycosylation or cysteine-oxidation to increase protein stability (TEVp-3M). Western Blot analysis showed that TEVp-3M is more stable in vitro and in vivo. As a proof of principle, we also tested the new TEVp variant by tagging the postsynaptic glutamate-gated chloride channel GluCl α with a TEVcs near an extracellular functionally critical sequence. The TEVp-3M variant showed stronger cleavage of GluCl α -TEVcs in S2 cells, compared to the wild type TEVp. GluCl α is an important protein for circuit function in vivo, and loss of GluCl α leads to increased lethality and locomotor deficits (Kane et al., 2000). Using this as a read-out in vivo, we found that cutting of GluCl α -TEVcs by pan-neuronally expressed TEVp3M in vivo led to increased lethality, suggesting that our novel TEVp variant will be a useful tool for the analysis of circuit function.

Our improved TEVp can be applied in any *Drosophila* circuit, and should also improve functionality in other organisms. We aim to further validate the extracellular TEVp by cutting essential synaptic proteins by using available MiMIC lines carrying a TEVcs. Once successful, TEVp mediated proteolysis could be flexibly used to achieve protein-specific disruptions to obtain a detailed causal understanding of neural circuit function.

Inferring network connectivity using modified Reservoir Computing

Pablo Rojas¹, Marie Kempkes¹, Martin E. Garcia¹

¹University of Kassel, Theoretical Physics, Heinrich-Plett-Str. 40, 34132 Kassel, Germany

Inferring directed links in networks of interacting systems is a problem spanning many disciplines. Systems out of equilibrium represent a special case, where samples are not independent but structured as time series. Extracellular electrophysiology recordings fall in this category, and inferring the connectivity between the measured units is often crucial to understand network function. In this context, artificial Recurrent Neural Networks (RNNs) have attracted recent attention, due to their ability to learn dynamical systems from sequences. We introduce a method to infer connectivity of a network from the time series of its nodes, using a RNN based on Reservoir Computing (RC). We show how modifications of the standard RC architecture enable a reliable computation of the existence of links between nodes. While the method does not require information about the underlying mathematical model, its performance is further improved if the selection of hyper-parameters is roughly informed by knowledge about the system. The method is illustrated with examples from different complex systems, to show its applicability beyond biological neural networks. Using simulations of these systems, we demonstrate its power and limitations under a variety of conditions, such as noise levels, delayed interactions, size of the network and hidden variables.

Intracellular in vivo recording in the Mauthner neuron efficiently reveals effects of substance exposure on the mature vertebrate brain.

Peter Machnik¹, Elisabeth Schirmer¹, Benedikt Maric¹, Stefan Schuster¹

¹University of Bayreuth, Department of Animal Physiology, Universitätsstraße 30, 95440 Bayreuth, Germany

The two reticulospinal Mauthner neurons (MN) play a key role in the vital neuronal network underlying the teleost short-latency C-start (SLC). Fish perform the SLC to escape sudden threat. Within the SLC network, the MNs integrate sensory information, and, when activated, the single action potential fired by one of the two MNs initiates all the processes which are part of the fish's SLC response. Activation of the right MN triggers escaping to the left, activation of the left MN triggers escaping to the right.

However, corresponding to its natural function within the SLC network, the teleost MN combines a number of features making it uniquely suited to examine in vivo the impact of substance exposure on all aspects of brain function. Although the MN lies deep in the medulla oblongata, it can be localized in vivo and is accessible to intracellular recordings. The MN is a so-called identified neuron. Each fish has only two such neurons and, using electrophysiological techniques, they can be individually identified in vivo from one fish to the next. Such a situation is rare in the vertebrate nervous system, but offers the enormous advantage that data specifically from this cell can be accumulated in separate experiments performed on different individuals. After establishing intracellular in vivo recording from the MN, a great number of crucial features can be determined in one go, for instance in substance hazard assessment. First, the MN integrates information from diverse sensory systems. This allows using a variety of sensory stimuli, recording the responses of the MN to them, and to work out this way the effect of a substance on each given sensory channel. Second, electrical stimulation of the spinal cord enables the antidromic activation of the MN. This allows studying action potential generation and processing in the MN in great detail. Third, the synaptic inputs into the two major dendrites of the MN use all transmitter systems known in the vertebrate brain. Impact on each of them can therefore be examined by recording from the MN. Fourth, the existence of mixed synapses in the lateral dendrite of the MN allows a particular elegant characterization of the effects of chemicals on the signal transmission of both electrical and chemical synapses.

To give an idea of the potential of intracellular in vivo recording in the MN to reveal effects of substance exposure on the mature brain, we present here results from determining whether everyday plastics affect adult brain function beyond the effects examined in standardized testing in risk assessment.

PinkyCaMP: A Novel Red Shifted Genetically Encoded Calcium Indicator with mScarlet

Ryan Fink¹, Jana Ottens², Martin Kubitschke¹, Olivia Masseck¹

¹Universität Bremen, Synthetic Biology, Leobener Straße 5, 28359 Bremen, Germany

Genetically encoded calcium indicators are powerful tools in not only neuroscience, but in much physiological research. Red GECIs offer benefits of having a longer emitting wavelength but existing sensors such as RCAMP and RGECO, which have cpmRuby and cpmApple respectively, come with two primary problems. First, existing red GECIs are dim – especially compared to green GECIs like GCAMP. Second, these red sensors are primarily stimulated by green light, yet they experience high photoactivation at lower wavelengths, such as blue and violet light, which makes them incompatible with many other optogenetic tools. To attempt to solve these problems, we utilized mScarlet, a fluorescent protein with higher brightness and better photoswitching dynamics, to successfully create a new red GECI (PinkyCaMP). Here we examine the dynamics of PinkyCaMP and its viability as a current and future alternative to existing red GECIs.

PyView: A general purpose tool for analyzing calcium imaging data

C Giovanni Galizia¹, Georg Raiser², Ajayrama Kumaraswamy¹

¹Universität Konstanz, Neurobiology, Universitätsstr. 10, 78457 Konstanz, Germany

²Champalimaud Centre for the Unknown, Avenida de Brasília, 1400-038 Lisboa, Portugal

Optical imaging allows to record network activity in many neurons simultaneously, yielding a direct access to network activity in the brain. The development of transgenic animals that express genetically encoded calcium reporters, such as GCaMP, has further increased the possibilities to study neural networks, other reporters, suitable for measuring membrane potential or specific second messengers are being developed in several labs. All of these techniques use changes in fluorescent light to quantitatively capture changes in neuron physiology, and all necessitate high-level image analysis tools in order to analyze the physiological data in a quantitative and consistent way.

Here, we propose a software for optical imaging analysis: pyVIEW (<https://github.com/galizia-lab/pyview>). pyVIEW splits data treatment into two steps: a powerful GUI for interactive data analysis, with flexible selection of evaluation parameters, and a second step for batch processing, yielding time traces, 2D images or 3D movies across all experimental measurements with identical parameter settings. The program is modular, and easy to expand with tools for dedicated analyses and/or experimental questions. The program is open source, written in python, and can be expanded to act as a wrapper for other programs that address single steps in a data analysis pipeline.

Information about example workflows, galleries of examples outputs, and guides for installing, using and developing pyVIEW are organized in a wiki (<https://github.com/galizia-lab/pyview/wiki>).

Targeting Noradrenergic Neurons of the Locus Coeruleus: A Comparison of Model Systems and Strategies

Chantal Wissing^{1,4}, Alexander Dieter^{1,2}, Maxime Maheu^{1,3}, Simon J. Wiegert^{1,2}

¹Synaptic Wiring Lab, Center for Molecular Neurobiology, University Medical Center Hamburg-Eppendorf, Hamburg, Germany;

⁴Current address: Institute for Vegetative Physiology, Neural circuits and behavior, University of Cologne, Cologne, Germany

²Institute for Neurophysiology, Medical Faculty of Mannheim, University of Heidelberg

³Section Computational Cognitive Neuroscience, Department of Neurophysiology and Pathophysiology, University Medical Center Hamburg-Eppendorf, Hamburg, Germany

The locus coeruleus (LC) noradrenergic system is involved in a plethora of physiological and pathophysiological processes. Refining our understanding of LC function largely relies on selective transgene expression in molecularly defined cells, enabling targeted manipulation and read-out of noradrenergic neurons. Here, we performed a side-by-side comparison of the most commonly used strategies and model systems enabling genetic access to the locus coeruleus. We report substantial differences among them both in terms of transgene expression efficacy, and in their molecular specificity. These findings are of critical importance for interpreting the results obtained from past experiments using the respective targeting strategies, as well as for the design of future studies.

The big, the fast and the blue: towards the optimal channelrhodopsin for the future optical cochlear implant

Aida Garrido Charles^{1,2,3}, Theocharis Alvanos^{2,4,5}, Kathrin Kusch^{2,6}, Tobias Moser^{2,3,7},
Thomas Mager^{1,2,3}

¹Advanced Optogenes Group, Institute for Auditory Neuroscience and InnerEarLab, University Medical Center Göttingen, Germany, 37075, Göttingen, Germany.

²Institute for Auditory Neuroscience and InnerEarLab, University Medical Center Göttingen, 37075 Göttingen, Germany.

³Cluster of Excellence "Multiscale Bioimaging: from Molecular Machines to Networks of Excitable Cells" (MBExC), University of Göttingen, 37075, Göttingen, Germany.

⁴Auditory Neuroscience and Synaptic Nanophysiology Group, Max Planck Institute for Multidisciplinary Science, 37077 Göttingen, Germany,

⁵International Max Planck Research School for Neurosciences and Göttingen Graduate Center for Neurosciences, Biophysics, and Molecular Biosciences (GGNB), University of Göttingen, 37075 Göttingen, Germany

⁶Functional Auditory Genomics Group, Auditory Neuroscience and Optogenetics Laboratory, German Primate Center, Göttingen, Germany

⁷Auditory Neuroscience and Optogenetics Laboratory, German Primate Center, 37077 Göttingen, Germany.

Around 5% of whole world's population can be affected by hearing impairment. The design of optical cochlear implants (oCIs) aims to improve hearing quality compared to the widely used electric cochlear implant. To provide light sensitivity to the auditory system we employ Channelrhodopsins (ChRs), naturally occurring photosensitive proteins. Optogenetic manipulation of spiral ganglion neurons (SGNs) has been reported, but efforts to improve the performance of ChRs for clinical translation are ongoing.

We designed and characterized blue light activated ChRs that meet the needs of hearing restoration by oCIs: high light sensitivity and good temporal fidelity. Both aspects are interconnected, and speed is usually in detriment of light sensitivity. Low light sensitivity can be compensated by higher membrane expression, achieved with membrane exporting sequences from Kir2.1 channel. Less desensitizing ChRs provide reproducible and sustained photoresponses over time for high frequency stimulation of SGNs. All these parameters were systematically compared in transiently transfected neuroblastoma-glioma cells and in hippocampal neuron primary cultures. Neuronal activation was studied regarding light pulse length, frequency, and light intensity.

Selected candidates optimized in vitro, were tested in vivo by direct injection of AAVs through the round window in early postnatal mice. In vitro measurements in cochlear nucleus show that light stimulation of SGN fibers evoke postsynaptic activity. Cochlear nucleus recordings help us to evaluate the effects of optogenetic manipulation in the auditory system.

In conclusion, here we show new refined gain of function mutant ChRs with great potential to be tested in established animal models for future clinical translation.

The Influence of Aldehyde Fixatives on Membrane Roughness as determined by Scanning Ion Conductance Microscopy

Marius Strachowitz¹, Dilan Yildiz¹, Heiko M. Lesslich¹, Irmgard D. Dietzel², Annika Haak¹

¹RG Nanoscopy, RUBION, Ruhr-Universität Bochum, Universitätsstraße 150, 44801 Bochum, Germany

²RG Electrobiochemistry, Department of Biochemistry II, Ruhr-Universität Bochum, Universitätsstraße 150, 44801 Bochum, Germany

Biological samples for microscopical imaging are predominantly fixed with aldehydes such as paraformaldehyde (PFA), glutaraldehyde, or combinations of these. These fixatives cross link proteins with varying effectiveness, depending on the concentration, incubation time, temperature, and pH value. This can alter the cytoskeletal morphology, reduce membrane integrity, and block epitopes. In the most recent studies aiming to find a fixative, which preserves cellular morphology better than PFA without causing sample fluorescence like glutaraldehyde, glyoxal has been proposed as a promising candidate [1]. However, the influence of glyoxal on the cell membrane's topography has so far not been investigated.

To better understand the influence of glyoxal on the outer cell membrane, we used scanning ion conductance microscopy (SICM), which is a contact free scanning probe microscopy technique to create 3D images of unlabeled lipid membrane surfaces. Our presently employed instrument provided topographical profiles with a resolution of approximately 100 nm. Furthermore, we gathered information on the roughness of an imaged surface by calculating the root mean square error (RMSE) of the topography's z coordinates [2]. This enabled us to investigate how glyoxal, in comparison to other aldehydes, influences the roughness of the cell's plasma membrane. Our experiments were conducted *in vitro* on primary astrocytes isolated from 0 to 2 day old Wistar rat pups at room temperature. Our preliminary experiments suggest that roughness values are higher following fixation with smaller aldehydes such as PFA and lower for bigger aldehydes such as glyoxal. This indicates that aldehyde fixation significantly affects membrane surface structures.

[1] Richter et al, The EMBO Journal 2018, 37, 139–159.

[2] Gesper et al, Nanoscale, 2017, 9, 14172–14183.

Unusual electric properties in the skin of electric catfish.

Susanne Proschke¹, Georg Welzel¹, Stefan Schuster¹

¹University of Bayreuth, Department of Animal Physiology, Universitätsstraße 30, 95447 Bayreuth, Germany

Electric catfish (*Malapteruridae*) generate electric discharges of hundreds of volts to shock the nervous system and the muscles of prey fish. Surprisingly, electric catfish itself are immune to both their own electric shocks and high-voltage discharges generated by an electrofishing device. Their nervous systems as well as their motor neurons are completely functional during and after their high-voltage discharges. It is still a mystery how electric catfish protect themselves from getting electrocuted. *Ex vivo* stimulation experiments with explanted catfish hearts have shown that their hearts lose their immunity to electric shocks when removed from the body. This raised the hypothesis that electric catfish are just insulated by a highly resistive skin. Here, we analysed for the first time the resistive properties of the electric catfish skin in comparison with other fish species including goldfish (*Carassius auratus*) and the weakly electric black knifefish (*Apteronotus albifrons*). For this we established an Ussing chamber approach that allowed us to directly send bipolar electric current pulses through the skins and determine their resistances. Our results clearly show that the transepithelial resistance for direct current in the skin of electric catfish is about 25 times higher than in goldfish and knifefish. In addition, we sent sinusoidal currents of variable frequency (10 Hz to 1 kHz) and amplitude through the skins to comparatively measure their impedances. Our results demonstrate that at each frequency the resistance of the electric catfish skin is independent of amplitude and at least about 10 times higher than in the other species. Moreover, resistance of the electric catfish skin decreased already at much lower frequencies than in the other species. In summary, the skin of the electric catfish has unusual electric properties that may contribute to their immunity to external shocks.

Author Index

[A](#) [B](#) [C](#) [D](#) [E](#) [F](#) [G](#) [H](#) [I](#) [J](#) [K](#) [L](#) [M](#) [N](#) [O](#) [P](#) [Q](#) [R](#) [S](#) [T](#) [U](#) [V](#) [W](#) [X](#) [Y](#) [Z](#)

- Abdulla, T [S7-5](#)
 Abe, P [T2-2A](#)
 Abele, S [T22-1C](#)
 Abou Rachid, S [T24-3B](#)
 Abusaada, A [T2-3A](#)
 Ache, J [S1-3](#), [S13-2](#), [S17-3](#), [T21-6A](#), [T21-2B](#), [T23-5A](#), [T23-6B](#), [T23-8C](#)
 Acimovic, J [T26-5A](#)
 Ackert-Smith, L [T21-2C](#)
 Acuna, C [T7-17C](#)
 Afanasenkau, D [S15-8](#)
 Agarwal, A [S18-5](#)
 Aggarwal, N [T13-6C](#)
 Aggarwal, S [T5-2C](#)
 Aggelopoulos, N [T16-2A](#)
 Agi, E [T2-3B](#), [T2-3C](#)
 Aguayo, L [T11-8A](#)
 Aguilar Perez, G [T7-6C](#), [S26-4](#)
 Ahmad, A [T7-9A](#)
 Ahmed, O [T25-12C](#)
 Ahmed, Z [S11-3](#), [S11-4](#), [S11-4](#), [T21-1B](#)
 Aimon, S [T19-10C](#)
 Akdas, E [T8-8A](#), [T15-4A](#)
 Akhtar, J [T14-3A](#)
 Akinola, E [T13-5C](#)
 Akol, I [T1-5A](#), [T10-1C](#), [T10-2C](#)
 Albrecht, A [T22-8B](#), [T23-7A](#), [T25-14A](#), [T27-5B](#)
 Alcaide Martin, A [T22-2B](#)
 Alcaino, C [S1-1](#)
 Alekseev, A [T27-6A](#)
 Alevyzaki, A [T22-3A](#)
 Alex, C [S15-6](#)
 Ali, M [T16-1A](#)
 Aliero, B [T22-8C](#)
 Aliyam Veetil Zynudheen, A [T14-5A](#)
 Allman, B [T10-6B](#)
 Altas, B [S8-1](#)
 Althaus, V [T14-3C](#)
 Altjohann, H [T12-3A](#)
 Altun, E [T27-8B](#)
 Aly, A [S10-3](#)
 Aly, A [T4-1A](#)
 Alzheimer, C [T7-11A](#), [T7-12A](#), [T7-2C](#), [T13-1B](#)
 Amann, L [T21-3B](#), [T21-3C](#)
 Ambrad, E [T26-7A](#)
 Amin, F [S6-5](#)
 Amin, N [T1-7A](#)
 Ammari, R [S13-1](#), [S34-3](#)
 Andersen, J [T1-7A](#)
 Andrade Mier, M [T9-2B](#)
 Andrea, K [T18-7C](#)
 Andreas, N [T12-3B](#)
 Andres-Alonso, M [S10-3](#)
 Andreu, B [T19-8C](#)
 Andrieux, G [S33-2](#)
 Angelaki, D [S11-2](#)
 Angenstein, N [T25-11B](#)
 Anisimova, M [T8-4A](#), [S13-8](#)
 Annamneedi, A [T11-5C](#)
 Antoine, J [T12-10B](#)
 Apostolides, P [T18-7B](#)
 Apostolides, P [T18-2A](#)
 Aravamudhan, A [T8-2B](#), [T25-8C](#)
 Araya, A [T11-8A](#)
 Arendt, T [T7-9C](#)
 Arian, J [T7-2A](#), [T7-5A](#), [T8-6A](#)
 Arican, C [T19-5C](#)
 Arioli, F [T12-7C](#)
 Arkhipov, A [T26-7B](#)
 Armijo-Weingart, L [T11-8A](#)
 Aronica, E [S24-2](#)
 Arrigoni, L [S23-5](#)
 Arrulo Pereira, A [T10-1B](#)
 Arzberger, T [T11-1B](#)
 Asadollahi, R [T7-9A](#)
 Ashcroft, F [T23-10A](#)
 Assmann, J [T11-11B](#)
 Atanasova, K [S19-4](#)
 Athanasiadis, M [T25-9A](#)
 Attardo, A [T8-4C](#), [T25-12A](#), [T25-13C](#)

Alvanos, T [T18-2B](#), [T27-7C](#)

Au Yeung, C [S30-1](#)

Aurich, S [T25-13A](#)

Aziz, A [T26-1A](#)

Author Index

[A](#) [B](#) [C](#) [D](#) [E](#) [F](#) [G](#) [H](#) [I](#) [J](#) [K](#) [L](#) [M](#) [N](#) [O](#) [P](#) [Q](#) [R](#) [S](#) [T](#) [U](#) [V](#) [W](#) [X](#) [Y](#) [Z](#)

Baade-Büttner, C [T12-3B](#)
 Badelt, R [T25-8B](#)
 Báez Mendoza, R [T24-6A](#)
 Bahader, I [T17-5B](#)
 Bahader, M [T17-1A](#)
 Bahl, A [S5-5](#), [T15-1C](#), [T19-4A](#), [T22-7C](#)
 Bähner, F [T26-2C](#)
 Bähr, M [T12-7A](#), [T12-10A](#), [T12-9B](#)
 Bai, X [T9-1A](#), [T9-7B](#)
 Baimacheva, N [T15-5A](#)
 Baines, R [T22-2A](#)
 Bais, D [T4-2B](#)
 Baker, S [T1-7A](#)
 Bakhareva, A [S13-7](#)
 Balaji, V [T15-1B](#)
 Bali, B [T17-4A](#)
 Balles, I [T23-8C](#)
 Balta, E [T8-2C](#)
 Baltissen, D [T8-5A](#)
 Baltissen, D [T11-5A](#)
 Bambah-Mukku, D [S14-4](#)
 Bandow, B [T25-3B](#)
 Bandow, P [T19-10C](#)
 Baral, A [T26-7A](#)
 Barayeu, A [S13-9](#)
 Barboni, M [S12-3](#)
 Bargeron, B [S6-5](#)
 Barheier, N [T11-10B](#)
 Bari, F [S29-5](#)
 Barnstedt, O [S6-5](#), [S13-10](#), [T25-19A](#)
 Barth, M [T11-9B](#)
 Bartoelke, R [S31-1](#)
 Bartos, M [T25-7A](#)
 Bartos, M [T24-1C](#), [T25-3A](#)
 Bashiri, M [T27-5A](#)
 Baskent, D [T18-1A](#)
 Bast, A [T14-2A](#)
 Batista, L [T19-5B](#)
 Batista, L [T2-1B](#), [T19-5A](#), [T25-19B](#)
 Battaglia, C [T23-6A](#)
 Bauer, M [T12-3B](#)
 Baumbach, J [T12-4B](#)
 Bausch, M [S35-5](#)
 Bayer, S [T15-4A](#)
 Beck, [T8-2C](#)
 Beck, H [S12-3](#), [S18-3](#)
 Beck, J [T8-6B](#), [T10-5C](#)
 Beck, L [T8-7A](#)
 Becker, S [T4-1C](#)
 Beckert, H [T7-10C](#)
 Beckervordersandforth, R [T1-2A](#), [T1-6C](#)
 Bedner, P [T9-8A](#)
 Beemelmans, C [T1-4A](#)
 Beemelmans, C [T1-4A](#)
 Behr, R [T12-5B](#)
 Behrad, A [T25-12B](#)
 Behrmann, E [T6-2A](#)
 Beiersdorfer, D [T9-1B](#)
 Bell, C [T6-5C](#), [T7-2A](#)
 Beltran, E [T11-1B](#)
 Ben Kraiem, A [T20-2B](#)
 Benda, J [T6-3C](#), [S13-9](#), [T26-6B](#), [T26-6C](#)
 Bender, F [T21-8A](#)
 Bengala, M [T18-8C](#)
 Bennühr, B [T12-3A](#)
 Bens, M [T12-4C](#)
 Beretta, C [T9-5B](#)
 Berg, L [S30-1](#)
 Bergmann, S [T4-1C](#)
 Bergmann, T [T18-1C](#)
 Bergmeier, M [T20-3A](#)
 Berneiser, T [T7-15B](#)
 Bernhardt, N [T13-5C](#), [S15-8](#)
 Bertrand, S [T23-1A](#)
 Bertsch, K [S19-3](#)
 Beste, M [T25-17B](#)
 Bestea, L [T19-2A](#)
 Beuermann, S [T7-4A](#)
 Beutler, L [S1-4](#)
 Beutner, D [T17-2A](#), [T17-2C](#)

Beyder, A [S1-1](#)
Beye, M [T19-8B](#)
Beyer, F [T1-2A](#)
Beyer, F [T1-6C](#)
Bhagwat, T [T12-9A](#)
Bhattacharya, S [T16-3B](#)
Bicakci, A [T25-5B](#)
Bidaye, S [S6-5](#)
Biermann, A [T25-17B](#)
Biglari, N [T22-6A](#)
Biju, R [T3-1C](#)
Bikbaev, A [T7-13C](#), [T27-8B](#)
Bikbaev, A [S8-5](#)
Bilkei-Gorzo, A [T9-6B](#)
Binder, S [T5-1C](#)
Birey, F [T1-7A](#)
Birkel, C [T11-4B](#)
Birkel-Töglhofer, A [T11-4B](#)
Bischofberger, J [T8-4B](#)
Bisen, R [S1-3](#), [T23-5A](#), [T23-8C](#)
Bistere, L [T25-10B](#)
Bitzenhofer, S [T23-7C](#), [T25-18B](#)
Blanchard, K [T19-2C](#)
Blaschek, A [S28-1](#)
Blenkle, A [T17-4A](#)
Blondiaux, A [T11-5C](#)
Blum, K [T6-3A](#)
Blunk, T [T9-2B](#)
Bobrowski, J [T18-5C](#)
Bock, J [T22-8C](#)
Bockemühl, T [S17-1](#), [T20-1B](#), [T20-3B](#), [T21-5A](#), [T21-5C](#), [T21-7C](#), [T21-9C](#), [T23-5A](#)
Böcker, J [T25-17B](#)
Böckers, P [S13-4](#)
Bodenhausen, A [T7-8B](#)
Boecker, C [T11-4C](#)
Boehlen, A [T9-6B](#)
Boehm, M [T13-6C](#)
Boehm, U [T9-2A](#)
Boerries, M [S33-2](#)
Bognar, A [T26-3C](#)
Bohmbach, K [S18-3](#)
Bohus, M [S19-2](#)
Bold, C [T8-5A](#)
Bold, C [T11-5A](#)
Bollmann, J [T16-1A](#)
Bonev, B [S23-3](#)
Bonin, V [T15-5A](#)
Boon, P [S15-2](#), [T27-6B](#)
Boreggio, L [T13-2B](#), [S28-4](#)
Borger, V [T25-15A](#)
Borghini, M [T7-10A](#)
Bornschein, G [T7-10B](#), [T7-13B](#), [T8-5B](#)
Borowsky, L [T18-5C](#)
Borsdorf, S [T5-2B](#)
Borst, A [T7-14B](#)
Bostel, J [T9-1B](#)
Boström, J [S35-5](#)
Botermann, D [T17-4A](#)
Both, M [T23-1B](#), [T23-3B](#), [T23-9C](#)
Bothe, M [S20-1](#)
Bozza, T [T19-2C](#)
Brachtendorf, S [T7-10B](#), [T7-13B](#)
Brack, A [T20-2B](#), [T20-2B](#)
Brainard, M [T21-3A](#)
Brainard, M [S25-1](#)
Brandenburg, C [S8-1](#)
Brandstätter, J [T15-4A](#), [T15-2C](#)
Brauer, A [T9-2A](#)
Braun, K [T22-8C](#)
Breer, H [T19-9C](#)
Brehme, M [S18-2](#)
Brembs, B [T25-2A](#)
Bremshay, S [T4-3C](#), [T9-3C](#)
Briggman, K [T15-3A](#)
Brinks, D [S22-5](#)
Brites, P [T7-11C](#)
Brochier, T [T26-5C](#)
Brockmann, A [T27-4A](#)
Brodersen, C [T23-6C](#)
Brodersen, C [T23-5C](#)
Brodt, S [T25-9A](#)
Brosch, M [T25-3C](#)
Brose, N [T7-9A](#), [T7-1B](#), [T9-5C](#), [S15-3](#), [T15-2C](#)
Brückner, J [T19-7A](#)
Brüge, A [T11-2C](#)
Brüning, J [T22-6A](#)
Brüning, J [T22-4C](#)
Brüning, V [T25-17A](#)
Brüstle, O [S30-1](#)
Bryska, A [T19-6A](#)
Buchholz, C [T11-5A](#)
Budinger, E [T21-6B](#), [T25-11B](#)
Bühler, K [T24-1A](#)
Bullmann, T [T7-9C](#), [S12-5](#)
Bunce, G [S8-1](#)
Burdina, N [T6-2A](#)
Burgalossi, A [T23-1B](#)
Burjanadze, M [T11-11A](#)
Burkart, M [T23-10A](#)
Burkhardt, S [T11-3B](#)

Büschges, A [S17-1](#), [T20-1B](#), [T20-3B](#), [T21-5A](#), [T21-9A](#), [T21-8B](#), [T21-5C](#), [T21-7C](#), [T21-9C](#)
Busse, L [T15-3C](#), [T16-1C](#)

Author Index

[A](#) [B](#) [C](#) [D](#) [E](#) [F](#) [G](#) [H](#) [I](#) [J](#) [K](#) [L](#) [M](#) [N](#) [O](#) [P](#) [Q](#) [R](#) [S](#) [T](#) [U](#) [V](#) [W](#) [X](#) [Y](#) [Z](#)

C. Brandão, S [T19-3C](#)
 Cabrera-Moreno, J [T25-10A](#)
 Cader, Z [S13-6](#)
 Caestecker, S [S15-2](#)
 Calapai, A [T25-10A](#)
 Calhoun, A [T25-12C](#)
 Caliskan, G [T25-14A](#)
 Cambridge, S [T15-5C](#)
 Camdessanché, J [T12-10B](#)
 Campos, J [T7-17C](#)
 Canneva, F [T11-6A](#)
 Cantacorps, L [T22-5A](#), [T22-5B](#)
 Cao, M [S13-1](#), [S34-3](#)
 Capelle, M [S5-5](#)
 Capelle, M [T15-1C](#)
 Carcaud, J [T19-2A](#), [T19-8B](#)
 Card, G [T21-7B](#)
 Cardona, A [T19-4C](#)
 Cardot, F [T23-6A](#)
 Casas, A [T12-4B](#)
 Casanovas, V [T21-3B](#), [T21-3C](#)
 Cascino-Milani, F [T23-6B](#), [T23-8C](#)
 Cases-Cunillera, S [T9-4C](#)
 Cassau, S [T19-7C](#), [T19-9C](#)
 Caudal, L [T9-7B](#)
 Cazzolla, G [T10-4A](#)
 Ceanga, M [T12-3B](#)
 Cervetto, C [T23-6A](#)
 Chakravarthy, V [T26-1A](#)
 Chandrasekar, A [T22-1C](#)
 Chang, H [T19-10B](#)
 Chang, H [T9-7B](#)
 Chang, Y [T19-2B](#)
 Chang, Y [S33-4](#)
 Chansoria, P [S30-3](#)
 Charnet, P [T25-6B](#)
 Cheffer, A [T1-5A](#), [T1-6A](#)
 Chen, A [T8-4C](#)
 Chen, H [T5-2C](#)
 Chen, H [T24-1C](#), [T25-3A](#)
 Chen, W [T22-6A](#)
 Chen, X [T1-7A](#)
 Chen, Y [T25-18B](#)
 Chepurwar, S [T17-2A](#)
 Chepurwar, S [T17-3A](#)
 Chepurwar, S [S32-1](#)
 Chernomor, O [T24-1A](#)
 Chertemps, T [T19-8C](#)
 Chesters, R [T22-5A](#), [T22-7A](#)
 Chhabra, A [T7-6C](#), [S26-4](#)
 Chhikara, A [T8-3B](#)
 Chien, M [S22-5](#)
 Chighladze, M [T11-11A](#)
 Chikte, P [T1-3B](#)
 Chini, M [S21-3](#)
 Chiovini, B [T27-3A](#)
 Chirich Barreira, L [T23-7A](#)
 Chkhikvishvili, N [T11-11A](#)
 Cho, S [T13-4C](#)
 Chockley, A [T23-8C](#)
 Choi, H [S9-4](#)
 Choi, M [T25-12C](#)
 Chojetzki, J [T14-1B](#)
 Christian, B [T13-6C](#)
 Christian, M [T17-2B](#)
 Chung, H [T12-3B](#)
 Churan, J [T21-8C](#)
 Cichy, A [T19-2C](#)
 Cillov, A [T18-6B](#)
 Cinelli, P [S15-6](#)
 Claussen, K [T4-3C](#)
 Clavet-Fournier, V [T8-2A](#)
 Clemens, J [T17-3B](#), [T19-7B](#), [T21-4C](#)
 Cloos, L [S19-5](#)
 Coenen, V [T13-4A](#), [T13-3B](#), [T13-4C](#)
 Cohen, I [T21-7B](#)
 Coldewey, S [T12-3B](#)
 Colin-Duchevet, L [T25-6B](#)
 Collet, C [T25-6B](#)
 Colón-Ramos, D [S10-1](#)

Comstock, M [T25-1A](#), [T25-12B](#)
Conedera, F [T9-4A](#)
Console-Meyer, L [T7-5C](#)
Constantin, O [T8-7A](#)
Constantinescu, A [T22-5C](#)
Cooper, B [T7-4A](#), [T9-5C](#), [S15-3](#), [T27-7A](#)
Cooper, B [T4-2A](#)
Cornean, J [T14-1B](#)
Cornelius, J [T13-6A](#)
Corneliussen, S [T19-1C](#), [T22-6A](#)
Corneliussen, S [T26-6A](#)
Correa, F [T6-1B](#)
Corredera Asensio, A [T21-2C](#)
Correia, B [T7-11C](#)
Corsini, N [S30-2](#)
Corthals, K [S20-2](#)
Costa, I [T10-5A](#)
Costalunga, G [T24-2C](#)
Costreie, M [T21-8A](#)
Coull, B [T22-7A](#)
Couto, A [T19-11A](#), [T25-6B](#)
Couzin-Fuchs, E [S15-9](#), [T19-4A](#), [T19-11B](#)
Craey, E [T27-6B](#)
Craig Curtis Garner , C [T11-5C](#)
Cravo, E [T24-3B](#)
Cremer, C [T3-1B](#)
Cronin, L [S3-4](#)
Crux, S [T26-7A](#)
Cui, B [T1-7A](#)
Cullen, D [T17-1B](#)
Curt, A [S15-6](#)
Cushion, T [T1-6B](#)
Custódio, R [T20-3B](#)
Czubay, K [T1-4A](#)

Author Index

[A](#) [B](#) [C](#) [D](#) [E](#) [F](#) [G](#) [H](#) [I](#) [J](#) [K](#) [L](#) [M](#) [N](#) [O](#) [P](#) [Q](#) [R](#) [S](#) [T](#) [U](#) [V](#) [W](#) [X](#) [Y](#) [Z](#)

D. Müller, T [T10-1B](#)
 d'Ettoire, P [T19-11A](#)
 D`uva, G [T19-5A](#), [T25-19B](#)
 D'Angelo, E [T23-6A](#)
 Dahlhoff, S [T21-6A](#), [T21-2B](#)
 Dahlmanns, M [T7-12A](#)
 Dai, K [T26-7B](#)
 Dalmau, J [S7-1](#)
 Daluegge, D [S13-10](#)
 Dalügge, D [T7-8A](#)
 Daniel, C [T19-5A](#), [T25-19B](#)
 Daniel, M [T20-5B](#)
 Dankovich, T [S16-5](#)
 Dapper, K [T18-1A](#)
 Dargvainiene, J [T12-3B](#)
 Darna, M [T10-2A](#)
 Das Gupta, A [T9-5B](#)
 Dashniani, M [T11-11A](#)
 Daumann, I [T2-4B](#)
 De Angelis, M [T10-1B](#)
 de Brito Sanchez, G [T19-2A](#)
 De Camilli, P [S26-3](#)
 de la Cuesta Ferrer, L [T26-4C](#)
 de los Santos Bernal, F [S9-4](#), [T24-5C](#)
 De Simoni, D [T12-6B](#)
 de Solis, A [T22-6A](#)
 Debinski, F [T15-3C](#)
 Dedek, K [T15-3A](#), [T15-1B](#), [S31-3](#)
 Degen, A [T19-9C](#)
 De-Groot, B [T17-2C](#)
 Dehmel, S [T16-2A](#), [T16-3B](#)
 Dehnen, G [T25-15A](#)
 Deimel, S [T25-7B](#)
 Deisseroth, K [T1-7A](#)
 Deistler, M [S21-4](#)
 Deller, T [T11-10C](#)
 Deneke, L [T8-6A](#)
 Denk, L [T5-2A](#)
 Denker, M [T23-10B](#), [T26-5C](#)
 Deppner, H [S32-2](#)
 Derksen, E [T24-4B](#)
 Dewan, A [T19-2C](#)
 Dhole, P [T26-7A](#)
 Diana, G [T21-8A](#)
 Dickinson, M [T21-7B](#)
 Dickson, B [T21-7B](#)
 DiCristina, G [T21-9A](#)
 Dieris, M [T19-1B](#)
 Diesmann, M [T26-5A](#)
 Dieter, A [T17-5C](#), [T27-1A](#), [T27-6C](#)
 Dieterich, D [T22-8B](#)
 Dietl, A [T26-4C](#)
 Dietrich, D [T7-3B](#), [T7-10C](#), [T9-2A](#), [T9-4C](#), [T11-11C](#)
 Dietzel, I [T27-8C](#)
 DiFilippo, A [T13-6C](#)
 DiGregorio, D [T7-16A](#), [T7-16A](#), [S32-3](#)
 Dileepkumar, D [T18-7B](#)
 Ding, L [T23-1B](#)
 Dinges, G [S17-1](#), [T20-1B](#)
 Dirnagl, U [S15-6](#)
 Dittman, J [T7-9A](#)
 Dityatev, A [T8-1C](#)
 Do, L [T12-10B](#)
 Do, T [T9-6C](#)
 Döbrössy, M [T13-4A](#)
 Döbrössy, M [T13-4C](#)
 Döbrössy, M [T13-3B](#)
 Doeppner, T [T12-7A](#)
 Doeppner, T [T12-10A](#), [T12-9B](#)
 Dogu, G [T18-8C](#)
 Doleschall, B [S30-2](#)
 Domart, F [T9-6C](#)
 Domianidze, T [T13-3C](#)
 Domingos, C [T9-6B](#)
 Donkels, C [T10-5C](#)
 Doppler, K [T12-8B](#)
 Dorn, K [T22-3B](#)
 Dorofeikova, M [T24-3A](#)
 Dosch, R [S10-4](#)
 Dou, D [T11-4C](#)

Dräger, O [T12-5A](#), [T20-3A](#)
Dragoi, V [T25-1C](#)
Draguhn, A [T23-1B](#), [T23-3B](#), [T23-9C](#)
Drakew, A [T11-10C](#)
Dresbach, T [T7-8C](#), [T9-6C](#), [T17-1C](#)
Drose, D [T19-6B](#)
Duan, Z [T13-3B](#)
Dubayle, D [T27-3B](#)
Dubochet, O [T23-6A](#)
Duch, C [T2-4A](#), [T6-2B](#), [T6-3B](#), [T7-2A](#), [T7-5A](#), [T8-6A](#), [T21-4A](#)
Dulac, C [S14-4](#)
Dullin, C [T17-5C](#)
Dunkel, E [T18-4A](#)
Duong, T [S2-3](#)
Dürr, V [T19-8A](#)
Durstewitz, D [T26-2C](#)
Dutheil, J [S31-2](#)

Author Index

[A](#) [B](#) [C](#) [D](#) [E](#) [F](#) [G](#) [H](#) [I](#) [J](#) [K](#) [L](#) [M](#) [N](#) [O](#) [P](#) [Q](#) [R](#) [S](#) [T](#) [U](#) [V](#) [W](#) [X](#) [Y](#) [Z](#)

Ebbers, L [T18-5C](#)
Ebding, J [T11-9B](#)
Ecker, A [S11-3](#), [T15-4B](#)
Eckes, A [T12-7B](#), [T19-7A](#)
Eckrich, S [T7-4B](#)
Edelmann, E [T8-1B](#)
Edemann-Callesen, H [T13-5C](#)
Effertz, T [T17-5B](#), [T17-2C](#)
Eggersmann, F [T7-8B](#)
Eglseer, K [T11-1B](#)
Ehmann, N [T8-7B](#)
Ehrhardt, E [T20-2A](#), [T20-1B](#), [T21-7B](#)
Ehsani, M [T11-9C](#)
Eichler, A [T8-6B](#)
Eickholt, B [S3-5](#), [T10-1A](#)
Eilers, J [T7-10B](#), [T7-13B](#), [T8-5B](#), [T23-10A](#)
Eilers, J [T7-9C](#)
Einevoll, G [T26-5B](#)
Eitelmann, S [S29-4](#)
El Khallouqi, A [T7-13C](#), [S8-5](#)
Elam, V [T13-6C](#)
Elger, C [S35-5](#)
Elhelbawi, A [T9-4A](#)
Elizarova, S [T7-1B](#), [T7-7B](#)
El-Keredy, A [T25-12B](#)
Elmaleh, M [T21-2C](#)
Elpelt, J [S27-5](#)
Elthoki, A [T6-1A](#)
Embray, L [T23-9C](#)
Emiliani, V [P3](#)
Ender, A [T6-5A](#), [T23-5C](#)
Endmayr, V [T12-6B](#), [S15-6](#)
Endres, T [T11-7B](#), [T25-5C](#), [T25-6C](#)
Engel, J [T6-3A](#), [T7-4B](#)
Engelhardt, M [T23-1B](#)
Engelmann, J [S10-4](#)
Engert, F [T22-7C](#)
Enjin, A [S20-2](#), [S20-3](#)
Enzmann, V [T9-4A](#), [S15-10](#)
Epifanova, E [T1-1C](#)
Erdle, S [T23-3A](#), [T24-2B](#)
Erdmann, I [T22-8B](#)
Eriksson, D [T16-2B](#)
Eriksson, D [T16-3A](#)
Erttmann, S [T11-9C](#)
Esch, K [S32-2](#)
Eschbach, C [S6-3](#)
Escher, M [S32-2](#)
Escribano, B [S15-5](#), [T25-15C](#)
Eshra, A [T7-13B](#)
Esiyok, N [T1-2B](#)
Essink, S [T26-4B](#)
Euler, H [T7-14C](#)
Euler, T [T15-3C](#), [T15-4C](#)
Everaerts, K [T6-2C](#), [S29-4](#)
Ewers, H [T7-6C](#), [S26-4](#)

Author Index

[A](#) [B](#) [C](#) [D](#) [E](#) [F](#) [G](#) [H](#) [I](#) [J](#) [K](#) [L](#) [M](#) [N](#) [O](#) [P](#) [Q](#) [R](#) [S](#) [T](#) [U](#) [V](#) [W](#) [X](#) [Y](#) [Z](#)

Fährnich, A [T9-7C](#), [T22-1C](#)
 Faiss, L [S13-5](#)
 Falahati, H [S26-3](#)
 Falfán-Melgoza, C [T9-5B](#)
 Falkai, P [P7](#)
 Fang, L [T9-1A](#), [T9-7B](#)
 Fang, Q [S32-5](#)
 Fanutza, T [S2-1](#)
 Farkas, E [T22-7B](#), [S29-5](#)
 Farrow, K [T15-5A](#)
 Farrugia, G [S1-1](#)
 Fauth, M [T8-1A](#), [T8-5C](#)
 Fehlings, M [S15-6](#)
 Fei, Y [S36-3](#)
 Feinstein, P [T19-2C](#)
 Fejtova, A [T7-10A](#)
 Fejtová, A [T15-4A](#)
 Fekécs, Z [T3-1C](#)
 Feller, N [S15-4](#)
 Felmy, F [T7-5C](#), [T7-7C](#), [T18-5A](#), [T18-9A](#), [T18-1C](#), [T23-10C](#)
 Felsenberg, J [S4-1](#), [S6-2](#)
 Fendt, M [T25-5B](#)
 Feng, K [T20-1B](#), [T21-7B](#)
 Fenton, G [T20-4A](#), [T20-5B](#), [T25-16C](#)
 Ferger, R [T18-6A](#)
 Feria-Pliego, J [S29-1](#)
 Fernandes, M [T26-7A](#)
 Fernandez d.V. Alquicira, T [T25-16B](#)
 Fernandez-Perez, E [T11-8A](#)
 Ferraud, K [T12-10B](#)
 Ferrea, E [T21-3B](#), [T21-3C](#)
 Ferreira, L [T23-1A](#)
 Ferreiro, D [T17-4C](#), [T18-8C](#)
 Feuerer, V [S26-3](#)
 Feussner, I [S10-4](#)
 Fiala, A [T25-1B](#), [T25-7B](#)
 Figge-Schlenk, R [S14-3](#), [T22-9C](#)
 Fink, R [T27-4C](#)
 Fiorilli, J [T23-10B](#)
 Fisch, J [T18-8A](#)
 Fischer, A [T9-5A](#)
 Fischer, A [T9-7A](#), [T11-3B](#)
 Fischer, B [T18-6A](#)
 Fischer, F [T7-6B](#)
 Fischer, M [S15-1](#)
 Fischer, P [T6-3A](#)
 Fischer, S [T23-6B](#)
 Fitzner, D [T12-9B](#)
 Fitzpatrick, D [S36-5](#)
 Flechtner, J [T25-9C](#)
 Fleidervish, I [T6-4B](#)
 Fleischer, J [T19-10B](#)
 Fleischmann, B [T9-8A](#)
 Fleischmann, P [S20-4](#)
 Flossmann, T [T16-1B](#)
 Folberth, J [T11-11B](#)
 Fontolan, L [T23-6B](#)
 Ford, A [T18-7B](#)
 Ford, A [T18-2A](#)
 Forlino, M [S5-3](#), [T19-2B](#)
 Formozov, A [T27-1A](#)
 Förster, E [T6-1C](#)
 Fortuna, M [T21-5B](#)
 Foster, J [T14-5A](#)
 Franch, M [T25-1C](#)
 Franconi, C [S33-4](#)
 Frank, R [S29-5](#)
 Franke, U [T25-13A](#)
 Franz, D [T11-7A](#), [T11-8C](#), [T21-7A](#)
 Franz, H [T25-4A](#)
 Franz, J [T11-10B](#)
 Franzelin, A [S13-8](#)
 Fratta, P [S8-2](#)
 Freckmann, L [T27-2A](#)
 Friauf, E [T7-3C](#), [T7-16C](#), [T18-8A](#), [T7-12C](#)
 Fricke, J [T11-5A](#)
 Fricke, S [T25-9C](#)
 Friedman, A [S24-4](#)
 Friedrich-Mueller, B [T24-2B](#)

Firzlaff, U [T18-5B](#), [T18-3C](#)

Frischknecht, R [T8-1C](#)

Fromm, S [T11-1A](#)

Fuchs, E [T23-8B](#)

Fuchsloch, M [S5-5](#)

Fuhrmann, F [S13-10](#), [T26-7A](#)

Fuhrmann, M [T4-3C](#), [T7-3B](#), [T11-2B](#), [T26-7A](#)

Fullio, C [T1-6A](#)

Fullio, C [S23-5](#)

Fusca, D [T19-1C](#)

Author Index

[A](#) [B](#) [C](#) [D](#) [E](#) [F](#) [G](#) [H](#) [I](#) [J](#) [K](#) [L](#) [M](#) [N](#) [O](#) [P](#) [Q](#) [R](#) [S](#) [T](#) [U](#) [V](#) [W](#) [X](#) [Y](#) [Z](#)

Gabele, L [T12-1B](#), [T12-2B](#)
 Gackstatter, A [T11-9B](#)
 Gaese, B [T18-4A](#)
 Gaffal, E [T5-1B](#)
 Gail, A [S11-3](#), [S11-4](#), [S11-4](#), [T21-1B](#), [T21-3B](#), [T21-5B](#), [T21-3C](#)
 Gais, S [T25-9A](#)
 Gál, L [T3-1C](#)
 Galanis, C [T8-2C](#), [T10-2C](#)
 Galizia, C [T27-5C](#)
 Galkov, M [T7-3B](#)
 Gallagher, C [T7-16B](#)
 Gallegos, S [T11-8A](#)
 Galvan, A [T13-6C](#)
 Ganapathy, S [S22-5](#)
 Ganglberger, F [T24-1A](#)
 Ganzella, M [T7-6C](#), [S26-4](#)
 Gao, R [S21-4](#)
 Gao, S [T12-1A](#)
 Garcia, A [T20-2B](#)
 Garcia, M [T19-2B](#)
 Garcia, M [S5-3](#), [T27-2C](#)
 Garcia Caceres, C [S34-1](#)
 Garcia Miralles, M [T1-5A](#)
 Garcia Perez, N [S30-1](#)
 Garcia-Miralles, M [T1-6A](#)
 García-Rama, C [T12-6C](#)
 Garg, V [S10-4](#)
 Garrido Charles, A [S13-3](#), [T27-7C](#)
 Gather, F [T10-2C](#)
 Gaudrain, E [T18-1A](#)
 Gaziano, I [T22-6A](#)
 Gebril, N [T9-4B](#)
 Gee, C [T8-7A](#), [T9-3A](#)
 Gee, C [T8-4A](#)
 Gee, C [S13-8](#)
 Gehrman, J [T10-5A](#)
 Geiger, J [T23-6C](#)
 Geiger, J [T23-5C](#)
 Gore, F [T1-7A](#)
 Geis, C [S7-5](#), [T7-9C](#), [S12-5](#), [T12-1A](#), [T12-9A](#), [T12-3B](#), [T12-4C](#), [T12-5C](#), [S24-5](#)
 Gelléri, M [T3-1B](#)
 Gelpi, E [T12-6B](#)
 Georgiev, S [S16-5](#)
 Georgiev, S [S33-4](#)
 Georgieva, K [T10-3B](#)
 Gerber, B [S6-5](#), [T25-1A](#), [T25-12B](#), [T25-4C](#)
 Gerdey, J [T4-3C](#)
 Geurten, B [S10-4](#)
 Ghelani, T [S32-2](#)
 Giannaki, M [T6-2C](#)
 Giannone, G [S26-4](#)
 Gierke, K [T15-4A](#)
 Giese, M [T26-3C](#)
 Gilestro, G [T26-3A](#)
 Giri, G [S20-3](#)
 Giurfa, M [T19-2A](#)
 Gjorgjieva, J [S21-2](#)
 Glickfeld, L [S36-4](#)
 Glienke, M [T13-5C](#)
 Gneisse, P [T4-3C](#)
 Godesberg, V [T21-9C](#)
 Goepfert, M [S10-4](#)
 Goldammer, J [T23-2A](#), [T25-8A](#)
 Goldschmidt, D [T19-6C](#)
 Goldsmith, C [S17-1](#)
 Gollisch, T [T15-1A](#), [T15-3B](#), [T15-4B](#), [T15-5B](#), [T15-6B](#), [T15-6C](#)
 Golmohammadi, A [T25-11A](#)
 Gomes, G [T11-2B](#)
 Gomez Guzman, C [T21-1A](#)
 Gompert, M [T22-3B](#), [T25-17A](#)
 Goncalves, L [T21-6B](#)
 Gong, W [T1-5B](#)
 Gonsel, A [T19-8A](#)
 Gonzalez-Palomares, E [T18-2C](#)
 Göpfert, M [T17-1A](#)
 Göpfert, M [T17-2C](#)
 Gunes, Z [T11-1B](#)

Gorgas, K [T11-2A](#)
Gorgi Zadeh, S [T26-7A](#)
Gorostiza, A [T20-3B](#)
Gorostiza, E [T21-5C](#)
Götthardt, M [T7-1A](#)
Götz , T [T7-12B](#)
Götz, T [S24-5](#)
Götze, J [T12-3B](#)
Goy, M [T11-9B](#)
Goya-Maldonado, R [T13-4B](#)
Grabietz, H [T1-4A](#)
Grabner, C [T7-6A](#)
Graf, F [T2-6A](#)
Graf, I [T12-7A](#), [T12-10A](#), [T12-9B](#)
Graff, S [T24-3B](#)
Grant, G [T1-7A](#)
Gratz, S [S32-2](#)
Greco, D [T11-10C](#)
Greguletz, P [T12-8B](#)
Grewe, J [S13-9](#), [T26-6B](#)
Gribble, F [S1-1](#)
Grob, R [S20-4](#)
Grochowska, K [T11-2B](#)
Groeneweg, F [T11-2A](#)
Gröger, N [T22-8C](#)
Groh, C [T8-3C](#)
Groppa, S [T21-6C](#)
Groschner, L [P2](#)
Groshkova, M [T18-2B](#)
Groß, J [T4-3C](#), [T27-8A](#)
Großjohann, A [T25-8B](#)
Groth, M [T12-3B](#), [T12-4C](#)
Grothe, B [T18-8B](#)
Grotz, M [T1-3C](#)
Grüb, J [T24-5B](#)
Gruber, L [T26-2A](#)
Gruhn, M [T21-9A](#)
Grün, S [T23-10B](#), [T26-4B](#), [T26-5C](#)
Grunenberg, J [T25-10A](#)
Grünewald, B [T19-8B](#)
Grünewald, B [T11-7C](#), [T12-8A](#)
Grünewald, K [T8-3B](#)
Grunwald Kadow, I [T19-10C](#)
Gschwendtberger, T [T11-6C](#)
Gu, R [T17-2C](#)
Guenzel, Y [T19-11B](#)
Gulati, S [T27-2B](#)
Gumbert, M [T18-8B](#)
Gundelfinger, E [T11-5C](#)
Gundelfinger, E [T11-4B](#)
Gundi, P [T18-8C](#)

Gunes, Z [T11-3C](#)
Guntermann, A [S15-6](#)
Günther, A [T15-3A](#)
Günzel, Y [S15-9](#)
Guo, H [T21-5B](#)
Gür, B [T14-2B](#), [T14-1C](#), [T27-1C](#)
Guthrie, C [T12-6B](#)
Gutnick, M [T6-4B](#)
Gutnick, M [T23-4C](#)
Gutt, A [T5-1C](#)
Gutzen, R [T26-5C](#)
Guzmán, A [T11-8A](#)

Author Index

[A](#) [B](#) [C](#) [D](#) [E](#) [F](#) [G](#) [H](#) [I](#) [J](#) [K](#) [L](#) [M](#) [N](#) [O](#) [P](#) [Q](#) [R](#) [S](#) [T](#) [U](#) [V](#) [W](#) [X](#) [Y](#) [Z](#)

Haak, A [T27-8C](#)
 Haas, C [T11-5B](#)
 Haas, C [T10-5C](#), [T11-6B](#), [T11-10B](#)
 Haase, A [T19-8B](#)
 Habelt, B [S15-8](#)
 Haberkern, H [T23-5A](#)
 Habermeyer, J [T11-6A](#)
 Hacker, D [S2-3](#)
 Hadjilaou, A [T12-3A](#)
 Haerteis, S [T5-2A](#)
 Hafez, O [T25-15C](#)
 Haffner, C [T1-2B](#)
 Hage, S [S25-4](#), [T26-1C](#)
 Hahn, N [T12-3B](#), [T12-4C](#)
 Hahner, L [T24-5A](#)
 Haidar, M [T14-4B](#)
 Haider, C [S15-6](#)
 Haider, T [S15-6](#)
 Halavatyi, A [T27-1B](#)
 Halim, V [T17-5B](#)
 Hallermann, S [T7-10B](#), [T7-13B](#), [T7-9C](#), [T8-2B](#), [T8-5B](#), [S12-5](#), [T25-8C](#)
 Hamauei, B [T20-5B](#), [T25-16C](#)
 Hametner, S [T12-6B](#)
 Hamker, A [T12-4B](#)
 Hammes, A [T1-2C](#)
 Hanafy, A [T11-11C](#)
 Hanganu-Opatz, I [S21-3](#), [T23-3C](#), [T23-7C](#), [T24-3A](#), [T25-18B](#)
 Hanganu-Opatz, I [T23-2B](#)
 Hansen, N [T11-4A](#)
 Hansson, B [T19-4B](#), [T19-10B](#), [T26-2A](#)
 Harczos, T [T17-3C](#), [T17-5C](#)
 Haret, R [T15-6B](#)
 Harpaz-Rotem, I [S4-4](#)
 Harris, A [T26-7C](#)
 Hartmann, A [T6-4A](#)
 Hartmannsberger, B [T20-2B](#)
 Harzsch, S [T19-9B](#), [T21-1C](#)
 Haselmann, H [S7-5](#), [T12-9A](#), [T12-3B](#), [T12-5C](#)
 Hatton, C [T25-6B](#)
 Haubensak, W [T24-1A](#)
 Haubrich, A [S18-3](#)
 Hauke, V [T7-15B](#), [T10-4A](#), [S12-5](#)
 Haug, N [T26-7B](#)
 Hauke, V [T7-9C](#)
 Hause, G [T19-9C](#)
 Hausen, C [T22-4C](#)
 Häussler, U [T11-5B](#), [T11-6B](#), [T11-10B](#)
 Haustein, M [T21-5A](#)
 Haverkamp, S [T15-3A](#)
 Hawellek, D [T26-1C](#)
 Hawlitschka, A [T11-10A](#)
 Hayashi, Y [T25-3B](#)
 Haybäck, J [T11-4B](#)
 Hayes, N [S1-4](#)
 He, J [T22-3B](#)
 Hechavarria, J [T18-7A](#), [T24-6C](#)
 Hechavarria, J [T18-2C](#), [S25-3](#)
 Heck, J [T7-13C](#), [S8-5](#), [T27-1B](#)
 Hecker, A [T3-2A](#), [T22-1B](#)
 Heckmann, J [T12-1A](#)
 Heckmann, M [S7-5](#), [T12-1A](#)
 Hedrich, U [T6-1A](#)
 Hedrich, U [S12-4](#)
 Hedwig, B [T17-1B](#)
 Heerddegen, M [T11-8C](#)
 Heerdegen, M [T11-7A](#), [T21-7A](#)
 Hehlert, P [S10-4](#), [T17-2C](#)
 Heide, M [T1-1A](#), [T1-2B](#)
 Heidrich, L [S30-1](#)
 Heiland, D [T8-2C](#)
 Heim, F [T25-11C](#)
 Heim, M [T25-2B](#)
 Heimrich, B [T6-4A](#)
 Hein, B [S27-5](#)
 Heine, M [T7-10A](#), [T7-13C](#), [S8-5](#), [T8-3B](#), [S32-2](#)
 Heining, K [T11-5B](#), [T11-6B](#)
 Heinrich, R [S10-4](#), [T12-5B](#)
 Heinz, N [T9-7B](#)

Hassan, B [S27-1](#)
Hasselmann, T [T25-17A](#)
Heinze, A [S2-3](#), [T2-5C](#)
Heinzl, S [T7-6B](#)
Held, M [T23-5A](#), [T23-8C](#)
Helfrich, R [S35-3](#)
Hempel, N [T12-3B](#)
Heneka, M [T11-12B](#)
Henke, C [T27-2A](#)
Henneberger, C [T9-4B](#), [T9-6B](#), [S18-3](#), [S29-1](#)
Hennessey, P [T26-6C](#)
Henning, L [T9-8A](#)
Henning, M [T14-1C](#)
Henschke, J [T23-7A](#)
Henseler, J [T18-1B](#)
Herlitze, S [T7-13C](#)
Herlitze, S [S8-5](#)
Herpertz, S [S19-3](#)
Herrera-Molina, R [T27-8B](#)
Herrmann, J [T11-9B](#)
Hertenberger, Y [T19-4A](#)
Hertrich, N [S2-1](#)
Herzel, H [S5-4](#)
Hess, A [T24-1A](#)
Hess, K [T12-6B](#)
Hess, S [T22-4C](#)
Heuer, H [T22-3A](#), [T22-2B](#)
Heuer, H [T10-1B](#)
Heutink, P [T11-3B](#)
Hiesinger, P [T2-6A](#), [T2-3B](#), [T2-4B](#), [T20-2C](#)
Hilbig, T [T17-4C](#)
Hilgert, S [T2-4A](#), [T6-3B](#), [T7-5A](#)
Hill, K [S18-3](#)
Hiller, K [T12-8C](#)
Hilpert, S [T23-8C](#)
Hirase, H [S18-1](#)
Hirnet, D [T9-3A](#), [T12-3A](#)
Hirrlinger, J [T10-3C](#)
Hirtz, J [T18-7C](#), [T25-15C](#)
Hiryu, S [T17-6A](#)
Hnida, M [T23-3C](#)
Ho, W [T7-2B](#)
Hoch, G [T17-3C](#)
Hodapp, A [T23-1B](#)
Hodzic, S [T7-1C](#)
Hoeflberger, R [T12-6B](#)
Hoffmann, A [T25-10C](#)
Hoffmann, C [T7-6C](#), [S26-4](#)
Hoffmann, L [T2-2B](#)
Hofmann, L [T7-12C](#)
Höftberger, R [S7-4](#), [S15-6](#)
Hogrefe, N [T27-2B](#)
Hohl, T [S23-5](#)
Höhn, L [T11-4B](#)
Höhne, L [T22-5C](#)
Hojas García-Plaza, I [S15-3](#)
Holcman, D [S32-2](#)
Holthaus, D [T11-9C](#)
Holvoet, H [T13-5A](#)
Holzbaur, E [T11-4C](#)
Holzer, M [T7-9C](#)
Homberg, U [T14-5B](#), [T14-3C](#)
Honorat, J [T12-10B](#)
Hore, P [S31-4](#)
Hore, P [S31-1](#)
Hörnberg, H [S9-1](#), [T13-1A](#), [T13-1C](#)
Ho-Shing, O [S14-4](#)
Hosokawa, K [T17-6A](#)
Hosseini, S [T12-9C](#)
Hosseini, S [T12-1B](#), [T12-2B](#), [T12-8C](#)
Hu, H [T10-4C](#)
Hu, X [T13-6C](#)
Hua, C [T25-10C](#)
Huang, G [T7-4B](#)
Huang, W [T9-1A](#), [T9-6B](#), [T9-7B](#)
Huang, Y [T15-3C](#)
Huber, D [S11-1](#), [T27-4B](#)
Huber, S [T10-5C](#)
Huebert, A [T19-8C](#)
Hüer, J [T21-5B](#)
Huet, A [T17-6B](#)
Huet, A [T18-1B](#)
Huetteroth, W [T20-4C](#)
Huettl, R [T25-12A](#)
Huettl, R [T8-4C](#)
Huguenard, J [T1-7A](#)
Hunniford, V [S22-2](#)
Hürkey, S [T2-4A](#), [T6-3B](#), [T21-4A](#)
Hurler, C [T11-1B](#)
Hußler, W [T11-4B](#)
Hust, M [S12-5](#), [T12-3B](#)
Huthmacher, L [T2-4A](#), [T6-3B](#)
Huttner, W [T1-1A](#), [T1-2B](#)

Author Index

[A](#) [B](#) [C](#) [D](#) [E](#) [F](#) [G](#) [H](#) [I](#) [J](#) [K](#) [L](#) [M](#) [N](#) [O](#) [P](#) [Q](#) [R](#) [S](#) [T](#) [U](#) [V](#) [W](#) [X](#) [Y](#) [Z](#)

Ibbotson, M [T16-3C](#)

Ihbe, N [T7-16B](#)

Ikeuchi, Y [S30-2](#)

Imig, C [T4-2A](#), [T7-4A](#), [T7-14A](#), [S15-3](#), [T27-7A](#)

Ioannidou, M [T19-5A](#)

Iqbal, F [S13-2](#)

Ireland, E [T25-12C](#)

Irsen, S [T15-3A](#)

Isbrandt, D [T11-9A](#), [S12-1](#), [T21-4B](#)

Ischebeck, T [S10-4](#)

Islam, M [T11-3B](#)

Ito, J [T26-4B](#)

Ito, K [T2-4C](#), [T20-2A](#), [T20-1B](#), [T21-7B](#), [T21-5C](#), [T22-6B](#), [T23-2A](#), [T23-8A](#), [T25-8A](#)

Izzo, A [T10-1C](#), [S23-1](#)

Author Index

[A](#) [B](#) [C](#) [D](#) [E](#) [F](#) [G](#) [H](#) [I](#) [J](#) [K](#) [L](#) [M](#) [N](#) [O](#) [P](#) [Q](#) [R](#) [S](#) [T](#) [U](#) [V](#) [W](#) [X](#) [Y](#) [Z](#)

Jabaudon, D [T2-2A](#)
Jablonski, L [T17-4B](#), [T17-3C](#), [T17-5C](#)
Jabs, R [T9-4B](#), [T9-6B](#)
Jack, A [S3-4](#)
Jacob, N [T25-12B](#)
Jacobs, T [T12-3A](#)
Jacquin-Joly, E [T19-8C](#)
Jaekel, S [T11-1B](#)
Jagannathan, S [T25-4B](#)
Jagannathan, S [T23-5C](#)
Jaguttis, S [T23-1C](#)
Jahn, O [T7-1B](#), [T7-15C](#), [T15-2C](#)
Jahn, S [T14-3C](#)
Jahnke, L [T9-4A](#), [S15-10](#)
Jahreis, K [T11-2C](#)
Jaime Tobon, L [T17-5A](#)
Jäkel, F [T26-4C](#)
Jakobsen, L [T18-5B](#)
Jakovcevski, M [T10-5A](#)
Jankowski, M [T25-18C](#)
Janning, M [T14-3C](#)
Jans, J [T7-9A](#)
Jansen, I [T7-6A](#)
Jaske, B [T14-2C](#)
Javadova, A [T18-5A](#)
Jeanson, L [T25-10A](#)
Jeschke, M [T25-10A](#)
Jhyont, H [T27-7B](#)
Jia, H [T25-13B](#)
Jiang, H [T26-5A](#)
Jiang, S [T11-8B](#)
Jiang, Y [T22-10C](#)
Joachimsthaler, A [T15-2A](#)
Johenning, F [S13-5](#)
John, D [T10-3C](#)
John, J [T9-5B](#)
John, O [T25-10C](#)
Jöhren, O [T12-7C](#)
Jones, H [T26-3A](#)
Joo, W [T22-7C](#)
Jucker, M [P4](#)
Judkewitz, B [S13-5](#)
Jung, S [T17-3A](#)
Jung, Y [T16-3C](#)
Junge, T [T10-3C](#)
Jurek, B [T5-2A](#)
Jürgensen, A [T25-4C](#)
Jurkus, R [T23-10B](#)
Just, J [T8-5A](#), [T11-5A](#), [T25-9C](#)
Jüttner, R [T7-1A](#)

Author Index

[A](#) [B](#) [C](#) [D](#) [E](#) [F](#) [G](#) [H](#) [I](#) [J](#) [K](#) [L](#) [M](#) [N](#) [O](#) [P](#) [Q](#) [R](#) [S](#) [T](#) [U](#) [V](#) [W](#) [X](#) [Y](#) [Z](#)

Kaas, T [T7-9C](#)
Kacmaz, H [S1-1](#)
Kaczanowska, J [T24-1A](#)
Kafitz, K [T1-5C](#), [T9-8B](#)
Kahl, E [T25-5B](#)
Kaindl, A [T10-4C](#)
Kaiser, B [T25-10C](#)
Kaiser, M [T23-1B](#)
Kaiser, M [T18-6C](#)
Kalin, N [T13-6C](#)
Kalinichenko, L [T7-2C](#)
Kalinicheno, L [T25-5B](#)
Kaltofen, S [T19-4B](#)
Kaminski, J [T11-1A](#)
Kampa, B [T24-3B](#)
Kampen, T [T9-5B](#)
Kämpf, F [T15-1C](#)
Kanaci, D [T25-18A](#)
Kaneko, H [T7-8A](#), [T11-2B](#), [S13-10](#)
Kannan, A [T7-4C](#)
Kapadia, A [T11-12B](#)
Kaplan, H [T16-1C](#)
Kapoor, R [T17-1C](#)
Karagulyan, N [S32-5](#)
Karakatsani, A [T20-4B](#)
Karakut, A [T14-1C](#)
Karcher, T [T19-9C](#)
Kargar, M [T16-2A](#)
Kargl, D [T24-1A](#)
Karpova, A [T4-1A](#), [S10-3](#), [T11-2B](#)
Karwinkel, T [S31-4](#)
Kasch, L [T22-5B](#)
Kaschube, M [S27-5](#), [S36-5](#)
Kasemir, J [T11-9A](#)
Kasprian, G [S30-2](#)
Kattler, K [T7-16C](#)
Kauer, M [T2-3C](#)
Kaurani, L [T9-7A](#), [T11-3B](#)
Kaushik, R [T8-1C](#)
Kaye, S [T19-2C](#)
Kazakov, A [T25-18C](#)
Keays, D [T2-2C](#)
Keays, D [T1-6B](#), [T16-1C](#)
Kelley, K [T1-7A](#)
Kelly, T [S12-3](#)
Kempe, I [T5-1A](#)
Kempkes, M [T27-2C](#)
Kempter, R [T23-5C](#)
Kenkel, A [T20-4B](#)
Keppeler, D [T17-4B](#)
Kersten, Y [T23-3A](#), [T24-2B](#)
Kessels, M [T12-9A](#)
Ketkar, M [T14-2A](#)
Kettenmann, H [S33-4](#)
Khare, P [T20-1A](#)
Kherbouche, O [T9-8A](#)
Khodaie, B [T8-1B](#)
Khosravian, M [T19-10B](#)
Khudayberdiev, S [S2-3](#), [T2-5C](#)
Khurana, L [T17-4B](#)
Kiai, A [T24-6C](#)
Kiani, N [S29-1](#)
Kilb, P [T2-3A](#)
Kilb, W [T3-2B](#)
Kilimann, * [T17-5B](#)
Killian, M [T12-10B](#)
Kilo, L [T6-2B](#), [T6-5C](#), [T7-2A](#)
Kim, J [T8-4C](#)
Kim, T [S32-1](#)
Kim, Y [T11-2C](#), [T11-6C](#)
Kins, S [T11-2A](#)
Kirchhoff, F [T9-1A](#), [T9-4B](#), [T9-6B](#), [T9-7B](#)
Kirischuk, S [T7-3A](#)
Kirmann, T [T7-9C](#), [S12-5](#)
Kirsch, J [T11-2A](#)
Kirsch, M [S33-2](#)
Kirschenmann, E [T14-5C](#)
Kirwan, P [T5-2C](#)
Kiss, E [T11-2A](#)
Kiss, V [T27-3A](#)

Kittel, R [T7-9C](#)
Kittel, R [T7-15C](#), [T8-2B](#), [T8-5B](#), [T8-7B](#), [T25-8C](#)
Kittel, R [T25-13A](#)
Kittel-Schneider, S [T1-4B](#)
Kizilirmak, J [T10-4B](#)
Kladisios, N [T7-7C](#), [T18-9A](#)
Klämbt, C [T9-8C](#), [S17-2](#)
Kleidonas, D [S33-2](#)
Klein, R [T24-7A](#)
Kleinert, J [T11-6C](#)
Kleinjohann, A [T26-4B](#)
Kleinlogel, S [T15-6C](#)
Kleinridders, A [T22-4C](#)
Kleinschnitz, C [T12-4B](#)
Kleis, P [T11-5B](#), [T11-6B](#)
Klemm, P [T22-6A](#), [T22-4C](#)
Klimmt, H [T8-4C](#), [T25-12A](#), [T25-13C](#)
Kling, A [T26-4A](#)
Klingler, E [T2-2A](#)
Klinkowski, S [T25-9A](#)
Kloppenburg, P [T7-8B](#), [T19-1C](#), [T22-6A](#), [T22-4C](#),
[T26-6A](#)
Klumpp, M [T23-1B](#), [T23-3B](#), [T23-9C](#)
Klußmann, J [T23-2A](#)
Klußmann, J [T19-1C](#)
Knabbe, J [T9-5B](#)
Knaden, M [T19-10B](#)
Knapska, E [S9-2](#)
Knief, C [T14-4B](#)
Knipper, M [T18-1A](#)
Knoblich, J [S30-2](#)
Knörnschild, M [S25-2](#)
Knorr, D [T12-5B](#)
Knowles, J [T1-7A](#)
Knutson, K [S1-1](#)
Kobayasi, K [T17-6A](#)
Kobel, K [T11-1C](#)
Koch, L [T18-4A](#)
Koch, M [T5-1A](#), [T9-3C](#)
Koch, P [T12-3B](#)
Kochlamazashvili, G [T10-4A](#)
Koesling, J [T10-5A](#)
Koessl, M [T18-7A](#), [T24-6C](#)
Kohl, J [S13-1](#), [S34-3](#)
Kohl, T [T17-1C](#), [S20-1](#)
Köhler, I [T2-2B](#), [S3-4](#)
Köhler, S [T10-3C](#)
Köhling, R [T11-7A](#), [T11-8C](#), [T21-7A](#)
Kohrs, F [T2-4B](#)
Kölbel, H [S28-1](#)
Kolligs, P [T7-6B](#)
Kolodziejczyk, M [T25-5B](#)
Konar-Nie, M [T11-8A](#)
Kong, D [T22-4C](#)
Kong, D [S27-5](#)
Konietzny, A [S2-1](#)
König, C [S6-5](#), [T25-1A](#)
Königsmann, S [T25-1A](#)
Kononenko, N [S10-2](#)
Koparkar, A [T25-11C](#)
Koparkar, A [T21-3A](#)
Köpke, H [T10-1B](#)
Kopp, M [S15-6](#)
Koppe, G [T26-2C](#)
Kopplin, L [T19-6A](#)
Körbelin, J [T10-1B](#)
Körber, C [T18-6C](#)
Korff, W [T21-7B](#)
Korotkova, T [S9-4](#), [S13-7](#), [S14-3](#), [T22-3C](#), [T22-9C](#),
[T24-7B](#), [T24-5C](#)
Korsching, S [T19-1B](#)
Korte, M [T8-5A](#)
Korte, M [T7-4C](#), [T11-5A](#), [T12-1B](#), [T12-2B](#), [T12-2C](#),
[T12-8C](#), [T12-9C](#), [T13-6A](#), [T25-15B](#), [T25-9C](#)
Kosinska, J [T11-11B](#)
Koß, C [T26-4C](#)
Kossen, R [T27-2A](#)
Kostka, J [T25-18B](#)
Kotler, O [T6-4B](#)
Kowalczyk, I [T1-2C](#)
Kowatschew, D [T19-1B](#)
Kozmava, K [T13-3C](#)
Kraft, M [T17-2B](#)
Kraft, N [T8-3C](#)
Kragelund, F [T11-7A](#)
Kramer, B [T12-6C](#)
Krämer, N [T10-4C](#)
Kranz, D [T21-2C](#)
Krause, G [T22-8B](#), [T27-5B](#)
Krause, M [T24-3C](#)
Krause-Utz, A [S19-2](#), [S19-5](#)
Krauße, S [T26-5C](#)
Krebs, A [S17-2](#)
Kreis, S [T21-6C](#)
Kremers, J [T15-2A](#)
Kremers, L [T15-4C](#)
Kretzschmar, D [T13-5A](#)
kreutz, M [T4-1A](#)
Kreutz, M [P8](#), [S10-3](#), [T11-2B](#)
Krick, N [T8-6A](#), [T22-2A](#)
Krieger, J [T19-10B](#), [T19-7C](#), [T19-9C](#)
Krishnan, K [T22-7C](#)

Kristóf, R [S15-7](#)
Krizbai, I [S15-7](#)
Krizman, M [T27-7A](#)
Krohn, J [T9-6C](#)
Krohn, M [T10-1B](#)
Kronenberg-Versteeg, D [T9-7A](#)
Kropf, J [T25-5A](#)
Kruashvili, L [T11-11A](#)
Krueger-Burg, D [S8-3](#)
Krüger, D [T9-7A](#)
Krüger, S [T19-9C](#)
Krumm, L [T23-5C](#)
Kruse, P [T8-6B](#)
Krutenko, T [S30-1](#)
Kubisch, C [T17-2A](#)
Kubista, H [S15-6](#)
Kubitschke, M [T4-3C](#)
Kubitschke, M [T27-4C](#)
Kübler, H [S15-9](#)
Kügler, A [T22-1A](#)
Kügler, S [T7-8C](#)
Kuhn, P [S12-5](#)
Kühn, N [T15-5A](#)
Kühn, R [S33-4](#)
Kuhse, J [T11-2A](#)
Kuijpers, M [S10-5](#)
Kulkarni, A [T2-5B](#)
Kulkarni, S [T1-7A](#)
Kulshrestha, D [S18-4](#)
Kumar, S [T11-12B](#)
Kumaraswamy, A [T27-5C](#)
Kümmel, M [T6-1C](#)
Kümmerlen, K [T19-9B](#)
Kuner, T [T9-5B](#)
Kunkel, S [T26-7B](#)
Kupke, J [T23-3B](#)
Kuropka, B [T7-9B](#)
Kurt, S [T6-3A](#)
Kürten, A [T9-1B](#)
Kurth, C [T1-4B](#)
Kurz, E [T25-15A](#)
Kurzke, J [T23-10A](#)
Kusch, H [T27-2A](#)
Kusch, K [S13-3](#), [T17-3A](#), [T17-4A](#), [T17-5B](#), [T27-7C](#),
[S32-1](#)
Kusumi, A [T7-6C](#), [S26-1](#), [S26-4](#)

Author Index

[A](#) [B](#) [C](#) [D](#) [E](#) [F](#) [G](#) [H](#) [I](#) [J](#) [K](#) [L](#) [M](#) [N](#) [O](#) [P](#) [Q](#) [R](#) [S](#) [T](#) [U](#) [V](#) [W](#) [X](#) [Y](#) [Z](#)

La Marca, C [T12-10B](#)
 Laber, D [T25-16B](#)
 Labus, J [T11-2C](#)
 Labus, J [T5-2B](#), [T11-6C](#)
 Lacal, I [S11-3](#), [S11-4](#), [S11-4](#), [T21-1B](#)
 Lacin, H [T23-5A](#)
 Lacoste, B [T23-1A](#)
 Lakes-Harlan, R [T23-5B](#)
 Lamberty, M [T7-15C](#)
 Lamothe, P [S18-2](#)
 Lamothe-Molina, P [S13-8](#)
 Lamothe-Molina, P [T8-7A](#)
 Lampe, J [T12-6A](#)
 Lamprecht, A [T11-11C](#)
 Landgraf, M [T22-2A](#)
 Lange, H [T5-1B](#)
 Langebrake, C [S31-2](#)
 Lang-Roth, R [T17-2A](#)
 Lantheaume, A [T11-1C](#)
 Lanzarini, F [T25-14C](#)
 Laprell, L [S18-2](#)
 Larcher, V [T19-2A](#)
 Larkum, M [S3-5](#), [S13-5](#)
 Larsen, L [S15-2](#), [T27-6B](#)
 Lascorz Massanet, R [T23-9A](#)
 Lasser, D [S15-5](#)
 Lasser, D [T7-14C](#)
 Lassmann, H [S15-6](#)
 Laube, B [T1-3C](#), [T4-2C](#), [T11-3A](#)
 Laue, M [T19-9C](#)
 Lauer, G [T1-4A](#)
 Laumann, M [T19-4C](#)
 Laurens, J [T25-14C](#)
 Lavalley, A [T2-2A](#)
 Layer, N [T6-1A](#)
 Lazarov, E [T26-2B](#)
 Le, S [T1-5C](#)
 Leber, S [T11-4B](#)
 Leberecht, B [S31-4](#)
 Lederle, L [T19-7A](#)
 Lee, B [T7-2B](#)
 Lee, C [T7-5B](#)
 Lee, S [T7-2B](#)
 Lee, S [T7-2B](#)
 Lee, S [T13-7A](#)
 Lee, W [T20-3A](#)
 Lehmann, J [T19-10B](#)
 Lehmann, N [T21-6B](#)
 Lehmann, N [T23-1B](#)
 Lehnart, S [T17-1C](#)
 Lehr, A [T25-2C](#)
 Lehtimäki, M [T26-5A](#)
 Leibold, C [T25-7A](#), [T25-9A](#), [S30-5](#)
 Lenschow, C [T23-1A](#)
 Lenz, M [T8-6B](#)
 Lenzi, I [T24-3B](#)
 Leopoldo, M [T11-2C](#)
 Lerche, H [T6-1A](#)
 Lesse, A [T22-8C](#)
 Lesslich, H [T27-8C](#)
 Leßmann, V [T8-1B](#), [T11-7B](#), [T25-5C](#), [T25-6C](#)
 Levina, A [S21-1](#)
 Leyboldt, F [T12-3B](#), [T12-6B](#)
 Li, C [T15-5A](#)
 Li, J [S4-4](#)
 Li, M [T1-7A](#)
 Li, Y [S15-10](#)
 Liang, L [S36-3](#)
 Libnow, J [T19-10B](#)
 Liebmann, M [T10-3C](#)
 Liebsch, F [T7-8B](#)
 Liebscher, S [S7-2](#), [T11-1B](#), [T11-8B](#), [T11-3C](#), [T12-2A](#)
 Liebscher, T [S15-6](#)
 Liedvogel, M [S31-2](#)
 Lien, Y [T11-5C](#)
 Lieser, M [T13-5C](#)
 Liessem, S [T23-5A](#), [T23-8C](#)
 lim, h [T24-7A](#)

Lim, S [T11-2C](#), [T11-6C](#)
Lima, S [T23-1A](#)
Lin, C [T9-7B](#)
Lin, D [S14-2](#), [T22-10C](#)
Lin, P [T3-1C](#)
Lind, R [T26-3A](#)
Linde, J [T25-14B](#), [T10-6C](#)
Lindner, B [S13-9](#)
Lindner, L [T17-4A](#)
Link, J [T11-5B](#), [T11-6B](#)
Linne, M [T26-5A](#)
Linne, U [T2-5C](#)
Linneweber, G [T14-4B](#)
Lion, L [S15-5](#)
Lippert, M [T18-3A](#)
Lippert, M [T25-3C](#)
Lippert, R [T22-5A](#), [T22-7A](#), [T22-5B](#)
Lippmann, K [T23-10A](#)
Lipstein, N [T7-9A](#), [T7-1B](#), [T7-7B](#)
Lis, S [S19-2](#), [S19-5](#)
Lischka, K [T16-1A](#)
Litke, C [T20-4B](#)
Liu, Q [T9-1A](#)
Liu, X [T19-7A](#)
Liu, Y [T23-8B](#)
Liutikaite, N [T1-1A](#)
Livesey, M [T5-2C](#), [T5-2C](#)
Lo, H [S13-5](#), [T19-11C](#)
Loannidou, M [T25-19B](#)
Lodge, M [T8-4B](#)
Logiacco, F [S33-4](#)
Lohr, C [T9-3A](#), [T12-3A](#)
Lohse, M [T7-9A](#), [T7-1B](#)
Loi, E [S12-5](#)
Loi, E [S24-5](#)
Long, M [T21-2C](#)
Lootens, T [T1-1B](#)
López Carballo, J [T7-1A](#)
Lopez-Jury, L [T18-7A](#)
López-Murcia, F [S15-3](#)
Lorch, C [S1-4](#)
Lörsch, L [T14-1B](#)
Löschner, J [S25-4](#)
Lourenço dos Reis, S [T13-2A](#)
Lovett, A [S14-4](#)
Löwel, S [T16-2A](#), [T16-3B](#), [T16-2C](#)
Lowell, B [T22-4C](#)
Lu, V [S1-2](#)
Luarte, A [T27-8B](#)
Luboeinski, J [T25-2C](#)
Lübstorf, T [S15-6](#)
Ludewig, S [T8-5A](#)
Lugo Ramos, J [S31-2](#)
Luhmann, H [T12-8A](#)
Luhmann, H [T3-1A](#)
Luhmann, H [T3-1B](#), [T3-2B](#), [T21-6C](#)
Luhmann, P [T2-3A](#)
Luikart, B [S3-3](#)
Luksch, H [S20-1](#)
Lurz, K [T27-5A](#)
Lüttig, A [T11-7A](#), [T11-8C](#), [T21-7A](#)
Lutz, D [S13-4](#)
Lutz, H [T11-3A](#)
Lütz, A [T7-8B](#)
Lützkendorf, J [S32-2](#)
Lux, U [T15-2C](#)
Luxem, K [S13-10](#)
Lyons, D [T22-7C](#)
Lysiuk, V [T7-12B](#)
Lyutova, R [T25-2A](#)

Author Index

[A](#) [B](#) [C](#) [D](#) [E](#) [F](#) [G](#) [H](#) [I](#) [J](#) [K](#) [L](#) [M](#) [N](#) [O](#) [P](#) [Q](#) [R](#) [S](#) [T](#) [U](#) [V](#) [W](#) [X](#) [Y](#) [Z](#)

M. Sundaram, S [T10-1B](#)
 Ma, M [T19-6A](#)
 Ma, X [T25-5C](#)
 Maaß, F [T7-4A](#)
 Macarron Palacios, D [T11-3A](#)
 Mach, J [T20-2C](#)
 Machnik, P [T27-3C](#)
 Machts, T [T24-5B](#)
 Maciag, F [T8-3B](#)
 Mackay, S [S35-5](#)
 Macke, J [S21-4](#)
 Mager, T [S13-3](#), [S22-2](#), [T27-6A](#), [T27-7C](#)
 Maglione, M [T10-4A](#), [S32-2](#)
 Maheu, M [T27-6C](#)
 Maiellaro, I [T8-2B](#)
 Mali, I [T5-2C](#)
 Malkemper, P [T20-4A](#), [T20-5B](#), [T25-16C](#)
 Malzacher, A [T17-4C](#)
 Mamedova, E [T7-14A](#)
 Mamo, T [T1-2C](#)
 Mancini, N [S6-5](#), [T25-12B](#)
 Mangoldt, C [T1-1B](#)
 Mani, S [T10-4C](#)
 Maniom, J [T8-7B](#)
 Manke, T [T10-1C](#), [S23-5](#)
 Mann, R [T10-6B](#)
 Manninen, T [T26-5A](#)
 Manthey, G [S31-2](#)
 Manzella, S [T27-6B](#)
 Mao, X [T1-3A](#)
 Mapelli, L [T23-6A](#)
 Maraslioglu-Sperber, A [T7-16C](#)
 Marcato, S [T25-2A](#)
 Marcello, E [S2-2](#), [S2-3](#)
 Marcoli, M [T23-6A](#)
 Marcus, K [S15-6](#)
 Margrie, T [T16-4A](#)
 Marguet, S [T21-4B](#)
 Maric, B [T27-3C](#)
 Mark, M [T7-13C](#), [S8-5](#)
 Markova, B [T22-3A](#)
 Martelli, C [T2-1B](#), [T19-5A](#), [T19-5B](#), [T19-3C](#), [T25-19B](#), [S27-2](#)
 Martinez-Reza, F [T2-2C](#)
 Martins-Costa, C [S30-2](#)
 Marton, A [T3-1C](#)
 Martus, P [S15-6](#)
 Marty, S [T19-11A](#)
 Masala, N [S18-3](#)
 Masouti, E [T1-2A](#)
 Masseck, O [T5-1A](#), [T9-3C](#), [T27-8A](#)
 Masseck, O [T4-3C](#), [T13-3A](#), [S22-3](#)
 Masseck, O [T27-4C](#)
 Mastrobattista, E [T24-6A](#)
 Mathejczyk, T [T14-4B](#)
 Mathias, G [T21-4B](#)
 Matitaishvili, T [T13-3C](#)
 Mauceri, D [T20-4B](#)
 Mawrin, C [T12-3B](#)
 May, C [S15-6](#)
 Mayer, S [S3-2](#)
 Mayer, S [T26-6B](#)
 Mayer, U [T24-4C](#)
 Mayerl, S [T22-3A](#), [T22-2B](#)
 Mazzaferro, S [T5-2C](#)
 McFadden, M [T7-16A](#)
 McNeill, R [T1-4B](#)
 Meenakshisundaram, A [S3-5](#), [T10-1A](#)
 Meier, C [T9-7B](#)
 Meijer, J [S5-1](#)
 Mein, N [T12-3B](#)
 Meinhardt, M [S15-8](#)
 Meis, S [T25-5C](#), [T25-6C](#)
 Meisel, C [S15-6](#)
 Melchers, A [T18-1A](#)
 Melley Sadanandan, S [T7-2C](#)
 Melloni, L [S35-2](#)
 Mencacci, N [T7-17C](#)
 Mendes, A [T23-1A](#)
 Mendoza, E [T25-11C](#)

Menon, R [S9-3](#)
Menyhárt, Á [T22-7B](#), [S29-5](#)
Menzel, R [P5](#)
Mercader Huber, N [T9-4A](#)
Mercado-Perez, A [S1-1](#)
Merdan-Desik, M [T18-3B](#)
Meric, A [T21-2B](#)
Meric, A [T21-6A](#)
Merkle, F [T5-2C](#)
Merseburg, A [T11-9A](#), [S12-1](#), [T21-4B](#)
Merz, C [S4-3](#)
Mészáros, Á [S15-7](#)
Methi, A [T11-3B](#)
Metz, I [S2-3](#)
Metzdorf, K [T25-9C](#)
Mey, J [T12-6C](#)
Meyer, E [T9-1A](#)
Meyer, G [T1-4A](#)
Meyer, J [T7-15C](#), [T15-2C](#)
Meyer, J [T9-8B](#)
Meyer, N [T4-3C](#)
Meyer, T [T11-9C](#)
Mezriczky, Z [T27-3A](#)
Michaelides, M [T13-6C](#)
Michaelsen-Preusse, K [T12-9C](#)
Michaelsen-Preusse, K [T12-1B](#), [T13-6A](#), [T25-15B](#)
Michalek, A [T25-11B](#)
Middeke, M [T18-4A](#)
Miehl, C [S21-2](#)
Miesenböck, G [T25-5A](#)
MiguelTelega, L [T13-3B](#)
Mihaly, A [T27-3A](#)
Mikhaylova, M [S2-1](#), [S2-3](#)
Mikulovic, S [S13-10](#)
Milani, N [T13-2B](#), [S28-4](#)
Milovanovic, D [T7-6C](#), [S26-4](#)
Minegishi, R [T21-7B](#)
Minev, I [S15-8](#)
Miroschnikow, A [T19-4C](#)
Mirzac, D [T21-6C](#)
Mishra, P [T26-7A](#)
Mitkovski, M [T7-9A](#)
Mittag, J [T10-1B](#), [T22-1C](#), [T22-5C](#)
Mittag, M [T4-3C](#), [T11-2B](#), [T26-7A](#)
Mittmann, T [T7-3A](#), [T7-7A](#), [T7-15A](#), [T7-16B](#)
Mizrahi, A [S14-1](#)
Mizuta, K [T25-3B](#)
Mlynarski, W [S36-2](#)
Mocellin, P [S13-10](#), [T25-19A](#)
Möck, M [T7-6B](#), [T20-3C](#), [T23-4B](#)
Meng, X [S22-5](#)
Moebius, W [S10-4](#)
Molina Obando, S [T14-1B](#)
Molina-Obando, S [T23-9B](#)
Moll, F [T24-2B](#)
Moll, F [T21-2C](#), [T23-3A](#)
Möller, C [T4-1C](#)
Molnar, Z [S3-1](#), [S3-5](#)
Molnár, K [S15-7](#)
Molnár, Z [T10-1A](#)
Monaca, F [S13-1](#)
Moneron, G [T7-16A](#), [T21-8A](#)
Monga, M [T18-4C](#)
Montag, M [T7-16C](#)
Montagné, N [T19-8C](#)
Montealegre-Z, F [T17-1B](#)
Montenegro Venegas, C [T11-5C](#)
Monteverdi, A [T23-6A](#)
Montgomery, S [T19-11A](#)
Monyer, H [T23-8B](#)
Monz, E [T23-6A](#)
Moodley, Y [T24-1A](#)
Morassut, I [T2-2A](#)
Morel, J [T27-3B](#)
Moreno Velasquez, L [S13-5](#)
Morgan, D [T22-4C](#)
Moritz, C [T12-10B](#)
Mørk, H [T26-7B](#)
Mormann, F [T25-15A](#), [S35-5](#)
Moscato, L [S9-4](#), [T24-5C](#)
Moschref, F [T9-5C](#)
Moser, T [T7-6A](#), [S13-3](#), [T17-4A](#), [T17-5A](#), [T17-4B](#),
[T17-6B](#), [T17-1C](#), [T17-3C](#), [T17-5C](#), [T18-2B](#), [S22-2](#),
[T27-6A](#), [T27-7C](#), [S32-4](#), [S32-5](#)
Motosugi, R [S32-1](#)
Mouritsen, H [T15-3A](#), [T15-1B](#), [S31-2](#), [S31-3](#), [S31-4](#)
Mudipalli, R [T1-7A](#)
Mudter, C [T21-2A](#)
Mudunuri, A [T19-9A](#)
Mueller, S [T13-6C](#)
Mukhopadhyay, M [T17-6C](#)
Mulholland, H [S27-5](#)
Müller, A [T22-8B](#)
Müller, C [T7-2C](#)
Müller, F [T9-6A](#), [T9-3B](#)
Müller, F [T26-4A](#)
Müller, I [T25-14A](#)
Müller, M [T25-17A](#)
Müller, M [T10-5B](#)
Müller, M [T4-3C](#)
Müller, P [T6-1A](#)

Müller, R [T14-5C](#)
Müller, U [T8-5A](#)
Müller, U [T11-5A](#)
Müller, V [S20-4](#)
Müller-Felber, W [S28-1](#)
Müller-Fielitz, H [T9-7C](#), [T10-1B](#), [T12-6A](#), [T22-1C](#),
[T22-5C](#), [T22-6C](#)
Müller-Seydlitz, E [T15-3C](#)
Müllner, F [T15-2B](#)
Münch, D [T19-6C](#)
Muñiz-Castrillo, S [T12-10B](#)
Munk, M [T18-1A](#)
Münkner, S [T7-4B](#)
Munoz-Castaneda, R [S14-4](#)
Munsch, T [T25-5C](#)
Murthy, B [T25-13C](#)
Murthy, B [T8-4C](#)
Murthy, M [T25-12C](#)
Musacchio, F [T26-7A](#)
Musall, S [T24-3B](#)
Mushtaq, Z [T7-14C](#), [S15-5](#)
Muthuraman, M [T21-6C](#)
Muysers, H [T24-1C](#), [T25-3A](#), [T25-7A](#)
Mykytiuk, V [T24-7B](#)
Myoga, M [T18-8B](#)

Author Index

[A](#) [B](#) [C](#) [D](#) [E](#) [F](#) [G](#) [H](#) [I](#) [J](#) [K](#) [L](#) [M](#) [N](#) [O](#) [P](#) [Q](#) [R](#) [S](#) [T](#) [U](#) [V](#) [W](#) [X](#) [Y](#) [Z](#)

Na, L [T10-4C](#)
Nabavi, B [T2-3B](#)
Nabbefeld, G [T24-3B](#)
Nagathihalli Kantharaju, M [T13-1C](#)
Nägerl, V [P6](#)
Nair, T [T16-2C](#)
Nakagawa, J [T10-5C](#)
Nakamura, K [S34-5](#)
Nakamura, Y [S34-5](#)
Namiki, S [T21-7B](#)
Nasri, F [T6-3A](#)
Nassar, E [S13-1](#)
Nawabi, H [S16-1](#)
Nawrot, M [T19-5C](#), [T25-4C](#), [T26-6A](#)
Nawrot, M [T26-2A](#)
Nebeling, F [T26-7A](#)
Neckel, P [S15-1](#)
Neef, A [T23-4C](#), [T26-2B](#)
Neef, J [T17-2A](#)
Negri, F [T8-1A](#)
Neher, E [T8-5B](#)
Nelken, I [T25-18C](#)
Nemcova, P [T7-10C](#)
Nerlich, J [T7-9C](#), [T8-5B](#), [S12-5](#)
Nessler, M [T19-3A](#)
Neuhaus, R [T22-6A](#)
Neukel, C [S19-3](#)
Neupert, S [T4-2B](#), [T22-1A](#), [T22-2C](#), [T23-7B](#)
Neve, V [T9-7C](#)
Niebur, E [T25-15C](#)
Nieder, A [T23-3A](#), [T24-2A](#), [T24-5A](#), [T24-2B](#), [T24-5B](#), [T24-6B](#), [S25-5](#), [T25-15A](#)
Niediek, J [T25-18C](#), [S35-5](#)
Niemann, P [T9-8A](#)
Niemeyer, N [T21-4A](#)
Niesner, M [T12-8B](#)
Niestroj, M [T19-6A](#)
Niewalda, T [S6-5](#), [T25-1A](#)
Nigi, E [T3-1B](#)
Nimpf, S [T16-1C](#)
Ninkovic, J [S26-5](#)
Ninnemann, O [T10-4C](#)
Nishino, S [T1-7A](#)
Nocerino, R [T21-8C](#)
Nógrádi, A [T3-1C](#), [S15-7](#)
Nógrádi, B [S15-7](#)
Nogueiras, R [T9-7C](#), [T10-1B](#)
Noh, K [T27-1B](#)
Nordmann, G [T16-1C](#)
Nothwang, H [T18-5C](#)
Nourizonos, A [S11-1](#), [T27-4B](#)
Novatchkova, M [S30-2](#)
Nowakowska, S [T18-1B](#)
Nowotny, M [T17-2B](#), [T18-3B](#), [T21-2A](#)
Nuske, M [S11-3](#)
Nussbeck, S [T27-2A](#)
Nuttin, B [T15-5A](#)

Author Index

[A](#) [B](#) [C](#) [D](#) [E](#) [F](#) [G](#) [H](#) [I](#) [J](#) [K](#) [L](#) [M](#) [N](#) [O](#) [P](#) [Q](#) [R](#) [S](#) [T](#) [U](#) [V](#) [W](#) [X](#) [Y](#) [Z](#)

O`Connor Giles, K [S32-2](#)
Obermayer, K [T26-3B](#)
Oberndorfer, S [T12-6B](#)
Oberste-Frielinghaus, J [T26-4B](#)
Ocsai, K [T27-3A](#)
Oelschlegel, A [T11-2B](#)
Oepen, A [T2-4C](#)
Oertner, T [S2-4](#), [T8-7A](#)
Oertner, T [T8-4A](#), [S33-1](#)
Oertner, T [S13-8](#), [S18-2](#)
Oestreicher, D [T17-3A](#), [S32-1](#)
Offermanns, A [T23-2B](#)
Ohl, F [T25-3C](#)
Ohl, F [T18-3A](#)
Ohlemiller, K [T17-6C](#)
Ohm, M [T12-8C](#)
Okamoto, A [T17-6A](#)
Okoli, O [S14-4](#)
Oler, J [T13-6C](#)
Oliveira, A [T23-3B](#)
Ollerenshaw, D [T27-2B](#)
Olmeo, C [T7-17C](#)
Olsen, M [T13-6C](#)
Opitz, S [T11-12B](#)
Opitz, T [S18-3](#)
Ortner, N [S32-5](#)
Osakada, T [S14-2](#), [T22-10C](#)
Osten, P [S14-4](#)
Otsuna, H [T21-7B](#)
Ott, T [T6-1A](#)
Ottaviani, A [T23-6A](#)
Otte, M [T19-8B](#)
Ottens, J [T27-4C](#)
Ouali Alami, N [T10-3B](#)
Oury, N [T22-7C](#)
Owald, D [S6-5](#), [T6-5A](#), [T23-5C](#), [T23-6C](#), [T25-2B](#), [T25-4B](#), [T25-16B](#)
Ozvár, J [T11-5C](#)

Author Index

[A](#) [B](#) [C](#) [D](#) [E](#) [F](#) [G](#) [H](#) [I](#) [J](#) [K](#) [L](#) [M](#) [N](#) [O](#) [P](#) [Q](#) [R](#) [S](#) [T](#) [U](#) [V](#) [W](#) [X](#) [Y](#) [Z](#)

Paap, M [T21-7A](#)
 Pabst, O [T19-6A](#)
 Pajer, K [T3-1C](#), [S15-7](#)
 Pak, V [T27-1B](#)
 Pakan, J [T23-7A](#)
 Palacios-Muñoz, A [T19-7B](#)
 Palfi, D [T27-3A](#)
 Pallinger, T [T17-3A](#), [S32-1](#)
 Palm, L [T22-7A](#)
 Palmeira do Amaral, A [S8-5](#)
 Palmeira do Amaral, A [T7-13C](#)
 Pampanin, V [T6-2B](#), [T6-5C](#)
 Pan, Y [T12-7A](#), [T12-10A](#), [T12-9B](#)
 Pandamooz, S [T5-2A](#)
 Pangrsic, T [T17-3A](#), [T17-6C](#)
 Pangrsic Vilfan, T [S32-1](#)
 Pankratz, M [T19-4C](#)
 Parbst, F [T23-7C](#)
 Pardi, N [T3-1C](#)
 Park, S [S9-5](#)
 Parnas, M [T8-7B](#)
 Parutto, P [S32-2](#)
 Pascal, S [T1-7A](#)
 Paschen, E [T11-5B](#), [T11-6B](#)
 Passlick, S [S29-1](#)
 Paterson, M [T22-5B](#)
 Patil, B [T26-1A](#)
 Patil, K [T7-3B](#)
 Patriarchi, T [S22-1](#)
 Pätz, C [T7-7C](#)
 Pätz-Warncke, C [T18-1C](#)
 Paul, S [T12-10B](#)
 Pauls, D [T25-13A](#), [T25-8B](#), [T25-8C](#)
 Pauls, S [T12-5B](#)
 Paulußen, I [T11-11C](#)
 Pecka, M [T17-4C](#), [T18-8C](#), [T25-16A](#)
 Pedersen, E [T1-1C](#)
 Peitz, M [S30-1](#)
 Peña, J [T18-6A](#)
 Peng, H [T11-9C](#)

Pennartz, C [T23-10B](#)
 Pensold, D [T10-5A](#)
 Peper, J [T27-1C](#)
 Perello Amoros, B [T8-1C](#)
 Perissinotti, P [T6-1B](#)
 Perl, O [S4-4](#)
 Perl, S [T11-7A](#), [T21-7A](#)
 Perreault, M [S17-5](#)
 Peschke, N [T3-1B](#)
 Petelski, I [T19-11B](#)
 Peter, A [T1-6C](#)
 Peter, S [T25-17B](#)
 Peters, C [T24-7A](#)
 Petersilie, L [T1-5C](#), [S29-4](#)
 Pethe, A [T6-4A](#)
 Petkar, R [T11-8B](#)
 Petri, S [T11-6C](#)
 Pettengell Jones, S [T12-2A](#)
 Petzold, A [S13-7](#), [S14-3](#), [T22-3C](#), [T22-9C](#)
 Petzoldt, A [T7-12B](#)
 Petzoldt, A [T2-1A](#)
 Pfeffer, T [S21-5](#)
 Pfeifer, D [S33-2](#)
 Pfeiffer, K [T14-5B](#), [T14-2C](#), [T14-4C](#), [T14-5C](#)
 Pfennig, V [T23-8B](#)
 Pflitsch, P [T22-7C](#)
 Pham, V [S30-2](#)
 Pielage, J [T7-14C](#), [T11-9B](#), [S15-5](#), [T19-7A](#), [T25-15C](#)
 Pierzchlinska, A [S6-5](#), [T20-1B](#)
 Pies, H [T12-5B](#)
 Pinto, C [T13-6B](#)
 Pinto, R [T11-3B](#)
 Piro, I [T12-7B](#)
 Pisupati, V [T5-2C](#)
 Piszczek, L [T24-1A](#)
 Pitschelatow, G [T25-14B](#), [T10-6C](#)
 Pitzalis, M [T19-2A](#)
 Pizzi, E [T7-3C](#)
 Platt, R [T2-2A](#)

Plessner, H [T26-5B](#)
Plessner, H [T26-7B](#)
Plötz, M [T12-8B](#)
Pochinok, I [S21-3](#)
Poeck, B [T13-5A](#)
Poeppel, D [T24-6C](#)
Pohl, T [T13-1A](#)
Poll, S [T26-7A](#)
Pollok, S [T4-3C](#)
Polterovich, A [T25-18C](#)
Pomberger, T [S25-4](#)
Ponimaskin, E [T5-2B](#), [T9-6A](#), [T9-3B](#), [T11-2C](#), [T11-6C](#), [T26-4A](#)
Ponimaskine, K [S2-4](#)
Popa, D [S6-4](#)
Popovich, P [S15-6](#)
Pöppel, J [T23-2B](#), [T23-3C](#), [T24-3A](#)
Poulopoulos, A [S8-1](#)
Powell, N [S27-5](#)
Pradhan, R [T9-7A](#), [T11-3B](#)
Praetz, M [T9-8C](#)
Preat, T [T25-10C](#)
Preissing, B [T8-6C](#)
Preobraschenski, J [T18-4C](#)
Preuss, F [T7-6B](#), [T23-4B](#)
Preuss, S [T16-1A](#)
Prevot, V [T9-7C](#), [T10-1B](#)
Priesemann, V [S30-4](#)
Prieto, J [T15-5B](#)
Prigge, M [T4-1A](#)
Prigione, A [T1-5C](#)
Prinz, M [T10-5C](#)
Prinz, M [S33-3](#)
Priyarangana Perera, R [S10-4](#)
Proce, R [T13-1C](#)
Project Team, F [T21-7B](#)
Proschke, S [T27-9C](#)
Prüß, H [S7-5](#), [S12-5](#), [S15-6](#)
Puchkov, D [T7-12B](#)
Pulin, M [T4-3C](#)
Puscian, A [T19-6A](#)
Puttagunta, R [S16-4](#)

Author Index

[A](#) [B](#) [C](#) [D](#) [E](#) [F](#) [G](#) [H](#) [I](#) [J](#) [K](#) [L](#) [M](#) [N](#) [O](#) [P](#) [Q](#) [R](#) [S](#) [T](#) [U](#) [V](#) [W](#) [X](#) [Y](#) [Z](#)

Quale, J [T4-2A](#)

Qualmann, B [T12-9A](#)

Quass, G [T18-7B](#)

Quass, G [T18-2A](#)

Quest, M [T24-5A](#)

Quilgars, C [T23-1A](#)

Quilitz, T [T17-4A](#), [T17-6B](#)

Author Index

[A](#) [B](#) [C](#) [D](#) [E](#) [F](#) [G](#) [H](#) [I](#) [J](#) [K](#) [L](#) [M](#) [N](#) [O](#) [P](#) [Q](#) [R](#) [S](#) [T](#) [U](#) [V](#) [W](#) [X](#) [Y](#) [Z](#)

Raabe, T [T24-4A](#)
 Raccuglia, D [T6-5A](#), [T23-5C](#), [T23-6C](#), [T25-4B](#)
 Rachad, E [T25-1B](#)
 Rachel, J [T7-6B](#), [T20-3C](#)
 Rademacher, N [T7-9B](#)
 Radermacher, J [T19-1C](#)
 Radermacher, J [T26-6A](#)
 Raedt, R [T1-1B](#), [S15-2](#), [T27-6B](#)
 Rahmati, V [S24-5](#)
 Rahmouni, K [T22-4C](#)
 Rai, S [S15-4](#), [T22-6C](#)
 Rais, C [T8-3A](#)
 Raiser, G [T27-5C](#)
 Ramakrishna, V [T15-6C](#)
 Ramanathan, C [T16-3A](#), [T16-2B](#)
 Rankovic, V [T17-3A](#), [S32-1](#)
 Raspe, S [T19-9B](#)
 Ratz, L [T13-4A](#)
 Rauch, A [T7-9A](#)
 Ravindran Nair, S [T21-4C](#)
 Reber, T [S35-5](#)
 Redavide, E [T22-8B](#)
 Redondo, C [T13-5B](#)
 Reh, F [T22-6B](#)
 Rehm, A [S3-4](#)
 Rehra, L [T11-5A](#)
 Rehrl, C [T3-2A](#)
 Reichard, J [T10-5A](#), [S23-2](#), [T25-14B](#), [T10-6C](#)
 Reifenstein, E [T2-3C](#)
 Reim, K [T7-15C](#), [T15-2C](#)
 Reimann, F [S1-1](#)
 Reiner, A [T4-3C](#), [S22-4](#), [S29-2](#)
 Reinert, A [T10-3C](#)
 Reinhard, K [T15-5A](#)
 Reis, S [T22-4B](#)
 Reissner, C [T11-2B](#)
 Remy, S [T7-8A](#), [T8-4C](#), [T11-2B](#), [S13-10](#), [T25-19A](#)
 Renken, K [T4-3C](#)
 Renken, K [T13-3A](#)
 Rennau, L [T2-2B](#), [S3-4](#)
 Renner, S [T15-3C](#)
 Rentsch, J [T7-6C](#), [S26-4](#)
 Reuss, B [T11-4A](#)
 Revah, O [T1-7A](#), [T23-4C](#)
 Rewitz, K [S1-5](#)
 Rhee, J [T7-5B](#)
 Rhee, J [T7-8C](#)
 Ribeiro, C [T19-6C](#)
 Richardson, R [S8-1](#)
 Richter, A [S4-2](#), [T10-2A](#), [T10-4B](#), [T11-4B](#)
 Richter, A [T10-2B](#), [T11-7A](#), [T11-8C](#), [T21-7A](#)
 Richter, F [T10-2B](#)
 Richter, M [T22-7B](#)
 Richter, V [T19-4C](#)
 Ricken, G [S15-6](#)
 Riedel, M [T13-6C](#)
 Riedemann, T [T7-1C](#)
 Rieger, N [T23-8A](#)
 Riehle, A [T26-5C](#)
 Rieke, N [T12-1B](#), [T12-2B](#)
 Riemensperger, T [T2-4C](#), [T22-6B](#), [T23-8A](#)
 Rigkou, A [T6-4C](#)
 Rihel, J [T22-7C](#)
 Rinas, T [T6-2B](#)
 Rinnert, P [T24-5A](#)
 Rist, A [T19-4C](#)
 Ritter, K [T22-5A](#), [T22-7A](#)
 Ritter, K [T12-1C](#)
 Rittner, H [T20-2B](#), [T20-2B](#)
 Ritz, S [T3-1B](#)
 Ritzau-Jost, A [T7-9C](#), [T8-5B](#), [S12-5](#)
 Rivalan, M [S13-5](#)
 Rizalar, F [S12-5](#)
 Rizalar, S [T7-9C](#)
 Rizzoli, S [S16-5](#)
 Robert, D [S20-5](#)
 Robertson, C [S8-1](#)
 Robin Hiesinger, P [T2-3C](#)
 Robinson, S [T12-6B](#)
 Rochefort, N [T16-1B](#)

Röcken , C [T12-6B](#)
Röderer, P [S30-1](#)
Rodriguez Polo, I [T12-5B](#)
Rogalla, M [T18-2A](#), [T18-7B](#)
Rogemond , V [T12-10B](#)
Rohde, S [T12-4B](#)
Rohr, L [T8-6C](#)
Rohwedder, A [T4-1B](#)
Rojas, L [T7-5B](#)
Rojas, P [T27-2C](#)
Rojas Caballero, A [T10-2C](#)
Roman, B [T1-1B](#)
Romaniello, R [T1-6B](#)
Romanowski, A [S8-1](#)
Romero-Ramírez, L [T12-6C](#)
Römschied, F [T25-12C](#)
Roos, L [S13-3](#), [T17-4A](#)
Rosário, M [T1-1C](#)
Rose, C [T1-5C](#), [T6-2C](#), [T9-8B](#)
Rose, C [S29-4](#)
Rose, R [T3-1B](#)
Roseboom, P [T13-6C](#)
Roselli, F [S16-2](#)
Rosenbaum, P [T21-8B](#)
Rosenmund, C [T11-5C](#)
Roska, B [T15-2B](#)
Rössler, W [T8-3C](#), [T19-5C](#), [S20-4](#)
Rost, B [S13-5](#)
Roth, F [T23-9A](#)
Rother, L [T14-4C](#), [T14-5C](#)
Rottschäfer, J [T17-3B](#)
Rouach, N [P1](#)
Roussa, E [T6-4A](#), [T6-2C](#), [T6-4C](#)
Roustazadeh, A [T18-3C](#)
Rozenfeld, E [T8-7B](#)
Rozov, A [T23-1B](#)
Rozsa, B [T27-3A](#)
Ruban, K [T8-3B](#)
Ruckerl, F [T21-8A](#)
Ruhwedel, T [S10-4](#)
Ruikes, T [T23-10B](#)
Ruiz de Almodóvar, C [T20-4B](#)
Russo, E [T26-2C](#)
Rust, M [S2-3](#)
Rust, M [T2-5C](#)
Ruthe, A [T21-8B](#)
Ruther, P [T17-5C](#)
Rutherford, M [T17-6C](#)
Rüttiger, L [T18-1A](#), [T18-6C](#)
Rybak, J [T26-2A](#)

Ryglewski, S [T2-4A](#), [T6-2B](#), [T6-3B](#), [T6-5C](#), [T7-2A](#),
[T21-4A](#), [S32-2](#)
Ryl, M [T15-4A](#)

Author Index

[A](#) [B](#) [C](#) [D](#) [E](#) [F](#) [G](#) [H](#) [I](#) [J](#) [K](#) [L](#) [M](#) [N](#) [O](#) [P](#) [Q](#) [R](#) [S](#) [T](#) [U](#) [V](#) [W](#) [X](#) [Y](#) [Z](#)

Saber, M [T18-6C](#)
 Sachidanandan, D [T8-2B](#), [T25-8C](#)
 Sackmann, T [T23-1B](#)
 Sadegh, S [T12-4B](#)
 Safari, N [T7-13A](#)
 Sainova, I [T1-4C](#)
 Saka, S [T27-1B](#)
 Sakagiannis, P [T25-4C](#)
 Sakai, N [T1-7A](#)
 Sakata, E [S32-1](#)
 Sakib, M [T9-7A](#)
 Sakib, M [T9-5A](#)
 Salehi, S [T5-2A](#)
 Salfenmoser, L [T26-3B](#)
 Samara, E [T7-14B](#)
 Sananbenesi, F [T11-3B](#)
 Sander, D [T19-9C](#)
 Sandhaeger, F [T26-1C](#)
 Sandoz, J [T19-2A](#), [T19-11A](#), [T19-8B](#), [T25-6B](#)
 Sans Dublanc, A [T15-5A](#)
 Santana Kragelund, F [T11-8C](#)
 Santinha, A [T2-2A](#)
 Santoro, B [T11-9A](#)
 Saraiva, M [T13-6B](#)
 Sarieva, K [T15-4C](#)
 Sathiyamani, J [T16-2C](#)
 Sato, M [T25-3B](#)
 Sauer, J [T24-1C](#), [T25-3A](#), [T25-7A](#)
 Saw, N [T1-7A](#)
 Sax, U [T27-2A](#)
 Saxena, S [T11-8B](#)
 Sayin, S [T14-4A](#), [T19-4A](#), [T19-11B](#)
 Scammell, T [T22-4C](#)
 Schaefer, M [T12-1C](#)
 Schäfer, M [T12-4A](#)
 Schäfer, N [T5-2A](#)
 Schara, U [S28-1](#)
 Scharff, C [T25-11C](#)
 Scharr, M [S15-1](#)
 Scheffer Teixeira, R [S9-4](#)
 Scheiwe, C [T10-5C](#)
 Schellenberger, M [T11-1C](#)
 Scheller, A [T9-1A](#), [T9-7B](#)
 Scherberger, H [T21-8C](#)
 Scherberich, J [T18-3B](#)
 Scherer, S [S15-1](#)
 Scheunemann, L [T25-16B](#), [T25-10C](#)
 Schickardt, Z [T1-4B](#)
 Schildknecht, J [T23-6A](#)
 Schiller, D [S4-4](#)
 Schirmeier, S [S18-4](#)
 Schirmer, E [T27-3C](#)
 Schirmer, I [T22-2C](#)
 Schlagenhaut, F [T11-1A](#)
 Schleimer, J [T21-4A](#)
 Schleyer, M [T25-4C](#)
 Schlungbaum, M [S13-9](#)
 Schlüter, O [T16-2A](#), [T16-3B](#)
 Schmahl, C [S19-1](#), [S19-2](#)
 Schmaljohann, H [S31-4](#)
 Schmid, S [T10-6B](#)
 Schmidbauer, P [T24-2A](#)
 Schmidl, L [T12-3B](#)
 Schmidt, A [T25-3B](#)
 Schmidt, H [T12-4B](#)
 Schmidt, H [T7-10B](#), [T7-13B](#), [T8-5B](#)
 Schmitt, F [T19-5C](#)
 Schmitt, O [T11-10A](#)
 Schmitt, T [T18-7C](#)
 Schmitz, A [T4-1C](#)
 Schmitz, D [S7-3](#), [T7-9B](#), [S13-5](#), [S24-5](#)
 Schnaitmann, C [T14-1A](#)
 Schneider, A [T19-2B](#)
 Schneider, A [S5-3](#), [T23-2C](#)
 Schneider, F [S2-3](#)
 Schneider, J [T10-4C](#)
 Schneider, T [T2-3C](#)
 Schneider, T [T6-2A](#)
 Schoch, S [T7-3B](#), [T7-10C](#), [T9-2A](#), [T9-4C](#)
 Schoch-McGovern, S [T11-12B](#)

Schödel, S [T24-3C](#)
Schoenherr, A [S13-5](#)
Schoer, J [T3-2B](#)
Scholz, H [T22-3B](#), [T25-17A](#), [T25-18A](#), [T25-17B](#)
Scholz, P [S10-4](#)
Schöne, C [T16-2A](#), [T16-3B](#), [T16-2C](#)
Schöneich, S [T17-2B](#), [T18-3B](#), [T21-2A](#)
Schönhense, E [S18-3](#)
Schönwolf, L [T11-7B](#)
Schork, F [T7-6B](#)
Schott, B [T10-2A](#)
Schott, B [T10-4B](#)
Schott, J [T14-3C](#)
Schreiber, S [T21-4A](#)
Schreiber, S [T11-4B](#)
Schröder, K [S5-3](#), [T19-2B](#)
Schröder, M [S3-4](#)
Schröder, S [T9-5A](#), [T9-7A](#), [T11-3B](#)
Schroeder, K [T19-3B](#)
Schroer, J [T3-1A](#), [T12-8A](#)
Schubert, T [T15-3C](#), [T15-4C](#)
Schuelke, M [S28-3](#)
Schukraft, N [T22-4B](#)
Schuldiner, O [T2-4C](#)
Schuldt, C [S2-3](#)
Schultheiss, P [T14-3B](#)
Schultz, T [T26-7A](#)
Schulz, A [T18-3A](#)
Schulz, A [T10-2B](#)
Schulz, J [T8-4B](#)
Schulz, J [T25-17C](#)
Schulz, K [T9-3A](#)
Schulze, A [S19-5](#)
Schulze, C [S2-4](#)
Schulze, H [T18-4B](#)
Schulze, W [T24-3C](#)
Schulze-Bonhage, A [T10-5C](#)
Schumacher, C [T22-3C](#)
Schümann, F [T11-10A](#)
Schuster, S [T3-2A](#), [T22-1B](#), [T24-3C](#), [T27-3C](#), [T27-9C](#)
Schwab*, J [S15-6](#)
Schwaninger, M [T5-1C](#), [T9-7C](#), [T11-11B](#), [T12-6A](#), [S15-4](#), [T22-7B](#), [T22-1C](#), [T22-5C](#), [T22-6C](#)
Schwaninger, M [T10-1B](#)
Schwark, M [S15-3](#)
Schwartz, G [S36-1](#)
Schwartz, O [S28-1](#)
Schwarz, G [T6-2A](#), [T7-8B](#)
Schwarz, G [T7-11B](#)
Schwarzbrunn, M [T12-3B](#)
Schwedhel-Domeyer, N [T12-5B](#)
Schweizer, M [T8-4A](#)
Schwenzer, N [T17-1C](#)
Schwiedrzik, C [S35-4](#)
Sciacca, G [T23-6A](#)
Scivoletto, G [S15-6](#)
Seeliger, S [T21-9A](#)
Segebarth, D [T11-1C](#), [T22-4B](#)
Seidenbecher, C [T8-1C](#)
Seidenbecher, C [T10-2A](#), [T11-4B](#)
Seidl, R [S30-2](#)
Seidler, L [T24-6B](#)
Seifert, F [T19-6A](#)
Seifert, G [T9-4B](#), [T9-6B](#), [T9-8A](#)
Seitz, K [S19-3](#)
Sell, J [S24-5](#)
Semtner, M [S33-4](#)
Sen, E [T25-12B](#)
Serdani, L [S15-6](#)
Sergaki, M [T2-2C](#)
Sermet, B [T21-8A](#)
Serrano-Lope, M [T22-5B](#)
Shaaban, A [T4-2A](#), [T7-4A](#), [T7-14A](#)
Shabani, H [T25-7A](#)
Shadron, K [T18-6A](#)
Shafiee , S [T8-7C](#)
Shah, M [T10-5C](#)
Shahidi, N [S11-3](#), [S11-4](#), [S11-4](#), [T21-1B](#)
Shamloo, M [T1-7A](#)
Sharkov, N [T23-3B](#)
Shen, L [T22-6A](#)
Shepherd, D [T21-7B](#)
Shi, K [T18-2A](#)
Shi, X [T12-9C](#)
Shin, S [T21-3A](#)
Shirdhankar, R [T20-5B](#)
Shirdhankar, R [T20-4A](#)
Shoaib, S [T23-7B](#)
Shoichet , S [T7-9B](#)
Sicorello, M [S19-3](#)
Sieben, A [T22-4C](#)
Sieben, C [T12-1B](#), [T12-2B](#)
Siegel, M [T26-1C](#)
Signoret-Genest, J [T13-2A](#), [T13-5B](#), [T22-4B](#)
Sigrist, S [T10-4A](#)
Sigrist , S [T7-12B](#)
Sigrist, S [S32-2](#)
Siklós, L [S15-7](#)
Silies, M [T14-2A](#), [T14-3A](#), [T14-1B](#), [T14-2B](#), [T14-1C](#), [T23-9B](#), [S27-4](#), [T27-1C](#)
Silva, A [T13-6B](#)

Simacek, C [T7-7A](#)
Simacek, C [T7-3A](#)
Simon, J [T23-9C](#)
Simon, M [T11-9B](#)
Simons, M [S33-5](#)
Simonson, O [S20-2](#)
Singhal, D [T20-1C](#)
Sinning, A [T3-1A](#), [T3-1B](#), [T3-2B](#), [T12-8A](#)
Sinz, F [T27-5A](#)
Sirota, A [T25-16A](#)
Sisignano, M [T20-2B](#)
Siwanowicz, I [T21-7B](#)
Skaar, J [T26-5B](#)
Skubal, M [T9-6B](#)
Slangewal, K [S5-5](#), [T15-1C](#)
Slutsky, I [T25-13C](#)
Smalla, K [T11-4B](#)
Smith, G [S27-5](#)
Sobierajski, E [T1-4A](#)
Sobolev, A [T18-8C](#), [T25-16A](#)
Soch, J [T10-4B](#)
Solov`yov, I [S31-4](#)
Soltanipour, M [T23-4A](#)
Somatakis, S [T25-12A](#)
Sommer, C [T12-7B](#)
Sommer, J [T7-9A](#)
Song, X [T20-1A](#)
Sonnenberg, L [T6-3C](#), [T26-6C](#)
Sosulina, L [T11-2B](#)
Sotelo Hitschfeld, T [T22-6A](#)
Soumyanath, A [T13-5A](#)
Soyka, H [S1-3](#)
Spanagel, R [S15-8](#)
Spanoghe, J [T27-6B](#)
Spehr, M [T19-3A](#), [T19-6A](#), [T19-10A](#), [T19-6B](#)
Spiecker, F [T9-7C](#), [T22-1C](#)
Sporar, K [T14-3A](#)
Sporbert, A [S33-4](#)
Sprenger, J [T26-4B](#)
Springer, M [T26-2A](#)
Spyropoulos, D [T5-1C](#)
Sridhar, S [T15-4B](#)
Städele, C [S5-2](#), [T19-1A](#)
Staiger, J [T1-3A](#), [T23-4B](#)
Staiger, J [T7-6B](#)
Staiger, J [T20-3C](#)
Stallwitz, N [T15-2A](#)
Stamatakis, A [T27-2B](#)
Stange-Marten, A [T18-3B](#)
Stapmanns, J [T26-5A](#)
Staudacher, E [T14-5B](#)
Stawyskyj, Z [T26-1B](#)
Steffen, J [T26-7A](#)
Steigmeier, M [T24-4A](#)
Stein, W [S5-2](#), [T21-1C](#), [T26-7C](#)
Steinhäuser, C [T9-4B](#), [T9-6B](#), [T9-8A](#)
Steinke, S [S12-5](#), [T12-3B](#)
Stella, A [T26-5C](#)
Stempel, V [S14-5](#)
Stengl, M [S5-3](#), [T19-2B](#), [T19-3B](#), [T23-7B](#), [T23-1C](#), [T23-2C](#)
Stephan, J [S29-4](#)
Stephan, R [S15-5](#)
Stern, D [T21-7B](#)
Stern, M [T4-1C](#)
Sternbach, M [T26-1B](#)
Steubing, R [T12-4B](#)
Steuernagel, L [T22-6A](#)
Stevens, C [T1-1B](#)
Stevens, N [T23-1B](#), [T23-3B](#)
Stiedenroth, H [T2-4B](#)
Stigloher, C [T8-3C](#)
Stöber, T [S21-3](#)
Stöhr, P [T8-6B](#)
Stolz, C [T10-2A](#)
Stopka, P [T19-6A](#)
Stork, O [T22-8B](#), [T25-14A](#)
Stork, S [T25-9C](#)
Strachowitz, M [T27-8C](#)
Straehle, J [T8-6B](#), [T8-2C](#)
Straka, H [S20-1](#)
Strange, B [S4-5](#)
Strauss, R [T13-5A](#)
Strege, P [S1-1](#)
Strenzke, N [T17-2A](#), [T17-3A](#), [T17-5B](#), [S32-1](#)
Striessnig, J [S32-5](#)
Stringhi, R [S2-3](#)
Strube-Bloss, M [T19-8A](#)
Strube-Bloss, M [T19-5C](#)
Stumpenhorst, K [S13-5](#)
Stumpf, A [S24-5](#)
Stumpner, A [T18-6B](#)
Stüttgen, M [T26-4C](#)
Suárez Grimalt, R [T23-5C](#)
Suárez-Grimalt, R [T23-6C](#)
Summavielle, T [T13-6B](#)
Sun, S [T7-9A](#), [T7-1B](#), [T7-7B](#)
Sun, Y [T12-2C](#)
Sun, Z [T11-9C](#)
Surbled, P [T23-6A](#)
Surdin, T [T8-6C](#)
Surendran, D [T25-14C](#)

Surges, R [T25-15A](#)

Svelha, P [T12-2A](#)

Switacz, V [T19-6B](#)

Syed-Nejadi, S [T21-9A](#)

Sylte, O [T24-1C](#)

Szczecinski, N [S17-4](#)

Szczecinski, N [S17-1](#)

Author Index

[A](#) [B](#) [C](#) [D](#) [E](#) [F](#) [G](#) [H](#) [I](#) [J](#) [K](#) [L](#) [M](#) [N](#) [O](#) [P](#) [Q](#) [R](#) [S](#) [T](#) [U](#) [V](#) [W](#) [X](#) [Y](#) [Z](#)

Tabuchi, R [T22-10C](#)
 Takahashi, N [T14-3C](#)
 Takao, M [T25-9B](#)
 Takeoka, A [S16-3](#)
 Talbot, C [T25-5A](#)
 Tam, Y [T3-1C](#)
 Tamai, Y [T17-6A](#)
 Tantirigama, M [S13-5](#)
 Taschenberger, H [T7-9A](#), [T8-5B](#), [S15-3](#)
 Tascio, D [T9-4B](#), [T9-6B](#)
 Tatenhorst, L [T12-7A](#), [T12-10A](#), [T12-9B](#)
 Taubert, M [T21-6B](#)
 Tavosanis, G [T7-3B](#)
 Tedesco, M [T23-6A](#)
 Tegtmeier, M [T25-17B](#)
 Teixeira, R [T24-5C](#)
 Teng, T [T19-2C](#)
 Tetzlaff, C [T7-13A](#), [T8-1A](#), [T8-7C](#), [T25-11A](#), [T25-2C](#)
 Thamm, M [T14-5C](#)
 Thedieck, K [T18-5C](#)
 Theil, S [T11-12B](#)
 Thiel, M [T20-2A](#)
 Thies, A [T24-3A](#)
 Thirumalai, A [T17-6B](#), [S32-5](#)
 Thoener, J [T25-1A](#)
 Tholance, Y [T12-10B](#)
 Thomas, M [T8-5C](#)
 Thomas, U [S32-2](#)
 Thome, C [T23-1B](#), [T23-3B](#)
 Thöner, J [T25-12B](#)
 Thum, A [T25-13A](#)
 Thum, A [T25-8B](#)
 Thum, A [T4-1B](#), [T19-4C](#)
 Thurm, M [T26-2C](#)
 Tian, L [S25-1](#)
 Timmann, D [S6-1](#)
 Timmermann, A [T9-6B](#)
 Tiss, T [T11-6C](#)
 Tøndel, K [T26-5B](#)
 Tong, Y [T13-3B](#), [T13-4C](#)
 Toppe, D [T10-4A](#)
 Török, D [T3-1C](#)
 Touboul, D [T19-8C](#)
 Tovote, P [T13-2A](#)
 Tovote, P [T11-1C](#), [T13-5B](#), [T22-4B](#)
 Trägenap, S [S36-5](#)
 Tran, T [T2-5B](#)
 Trautwein, N [T1-3C](#)
 Treede, R [T20-1C](#)
 Treue, S [T21-5B](#)
 Triesch, J [S21-3](#)
 Trimbuch, T [T11-5C](#)
 Triphan, T [T20-4C](#)
 Tritto, S [T23-6A](#)
 Trivedi, C [T16-1A](#)
 Trnka, F [T7-6C](#), [S26-4](#)
 Tröger, H [T19-10A](#)
 Truman, J [T21-7B](#)
 Tsunoyama, T [T7-6C](#), [S26-4](#)
 Tulke, S [T11-10B](#)
 Tunc, I [T26-6A](#)
 Tuoc, T [T1-3A](#), [S23-4](#)
 Tura, A [T13-4B](#)
 Turko, P [T8-6B](#)
 Tüzün, E [T12-7B](#)
 Tyagi, S [T7-4A](#)
 Tynianskaia, L [T1-1A](#)
 Tziridis, K [T18-4B](#)

Author Index

[A](#) [B](#) [C](#) [D](#) [E](#) [F](#) [G](#) [H](#) [I](#) [J](#) [K](#) [L](#) [M](#) [N](#) [O](#) [P](#) [Q](#) [R](#) [S](#) [T](#) [U](#) [V](#) [W](#) [X](#) [Y](#) [Z](#)

Udwari, D [T8-7A](#)
Ueberbach, T [T7-3A](#)
Uenaka, M [T17-6A](#)
Ugursu, B [S33-4](#)
Uhl, M [T17-4A](#)
Ul Maula Khan, A [T27-1B](#)
Ulivi, A [T25-12A](#)
Ulivi, A [T8-4C](#)
Ulmke, P [T1-3A](#)
Umadi, R [T18-5B](#)
Unichenko, P [S29-1](#)
Urban, J [T1-3B](#), [T14-1C](#)
Urbano, F [T6-1B](#)

Author Index

[A](#) [B](#) [C](#) [D](#) [E](#) [F](#) [G](#) [H](#) [I](#) [J](#) [K](#) [L](#) [M](#) [N](#) [O](#) [P](#) [Q](#) [R](#) [S](#) [T](#) [U](#) [V](#) [W](#) [X](#) [Y](#) [Z](#)

Valero Aracama, M [T7-11A](#)
Valero-Aracama, M [T7-12A](#)
Vallayer, P [T12-10B](#)
Vallentin, D [T21-1A](#), [T24-2C](#), [T25-10B](#), [T25-11C](#)
Valtcheva, S [S34-4](#)
van Agen, L [T10-5B](#)
van Albada, S [T26-5A](#)
van Bommel, B [S2-1](#), [S2-3](#)
Van Calenbergh, S [T27-6B](#)
van den Munkhof, H [S9-4](#), [S14-3](#)
van den Munkhof, H [T22-9C](#), [T24-7B](#)
van Heeck, R [T4-2C](#)
Vargas Figue, J [T23-9B](#)
Vaughn, E [S14-4](#)
Veit, J [T16-3A](#), [T16-2B](#)
Veit, L [T21-3A](#), [S25-1](#)
Velez-Fort, M [T16-4A](#)
Vennemo, S [T26-7B](#)
Venyi, M [T12-8A](#)
Vera, J [T23-10A](#)
Verbrüggen, M [T25-17A](#)
Verdiyan, E [T8-4B](#)
Verhage, M [S8-4](#)
Verhulst, S [T18-1A](#)
Vetter, D [T12-1C](#)
Vezzani, A [S24-3](#)
Vialou, V [T9-2C](#)
Vida, I [T8-6B](#)
Vieira, D [T11-5B](#)
Vieira, D [T11-6B](#)
Vieira, J [T20-4B](#)
Vielhaber, S [T11-4B](#)
Vijayan, A [S5-3](#), [T19-2B](#)
Vilceanu, A [T2-2C](#)
Vill, K [S28-1](#)
Villacampa, N [T11-12B](#)
Villmann, C [T9-2B](#), [T12-7B](#), [T12-8B](#)
Viotti, J [T7-8C](#)
Viskaitis, P [S34-2](#)
Vizler, C [T3-1C](#)
Vlachos, A [T8-6B](#), [T8-2C](#), [T10-2C](#), [T10-5C](#), [S33-2](#)
Vlasenko, A [T25-3C](#)
Vogel, J [T25-3B](#)
Vogel, T [T1-5A](#), [T1-6A](#), [T10-1C](#), [T10-2C](#), [S23-5](#)
Vogels, R [T26-3C](#)
Vogg, R [S11-3](#)
Vogl, * [T17-5B](#)
Vogl, C [T17-5A](#)
Vogt, K [T19-9A](#), [T24-1B](#)
Voigtländer, V [T26-1C](#)
Volk, A [T17-2A](#)
Vollbrecht, A [T11-6C](#)
von den Berg, S [T18-1C](#)
von Engelhardt, J [T11-7C](#), [T12-8A](#)
von Haeseler, A [T24-1A](#)
von Hörsten, S [T11-6A](#)
von Kalben, L [T9-3A](#)
von Kleist, M [T2-3C](#)
von Loh, S [T17-2A](#)
von Sivers, J [T7-9B](#)
von Stackelberg, N [T12-3B](#)
von Wittgenstein, J [T15-4A](#)
Vonck, K [S15-2](#), [T27-6B](#)
Vönhof, S [T12-4B](#)
Voorn, R [T17-5A](#)
Vuyyuru, H [T25-6C](#)
Vystrcilová, M [T15-4B](#)

Author Index

[A](#) [B](#) [C](#) [D](#) [E](#) [F](#) [G](#) [H](#) [I](#) [J](#) [K](#) [L](#) [M](#) [N](#) [O](#) [P](#) [Q](#) [R](#) [S](#) [T](#) [U](#) [V](#) [W](#) [X](#) [Y](#) [Z](#)

Wadle, S [T18-7C](#)
 Wagh, N [T14-3A](#)
 Wahle, P [T1-4A](#), [T2-2B](#), [S3-4](#)
 Wai, P [S13-1](#)
 Walker, M [S24-1](#)
 Wall, J [S20-2](#)
 Wallace, G [T18-7B](#)
 Wallhorn, L [T4-3C](#)
 Wallmeier, J [S28-2](#)
 Walter, A [S32-2](#)
 Walter, F [T2-2C](#)
 Walter, J [T11-12B](#)
 Walter, S [T2-1A](#)
 Walther, J [S19-2](#)
 Wang, A [T24-6A](#)
 Wang, Q [T7-15A](#)
 Wang, R [T8-4A](#)
 Wang, Y [S4-4](#)
 Wang, Y [T12-4A](#)
 WANG, Y [T10-4C](#)
 Wang, Y [T24-4A](#), [T24-4B](#)
 Wang, Z [T12-3B](#)
 Wani, M [T11-7C](#), [T12-8A](#)
 Warchol, M [T17-6C](#)
 Warm, D [T2-5A](#), [T3-1A](#), [T3-2B](#)
 Warren, T [T21-3A](#)
 Watkins, P [T15-3A](#)
 Weber, A [T27-8B](#)
 Weber, L [T27-2A](#)
 Weber-Fahr, W [T9-5B](#)
 Wee, A [T11-10A](#)
 Wegener, C [T24-4A](#), [T24-4B](#)
 Wegmann, J [S20-4](#)
 Wegner, M [T1-6C](#)
 Wegner, W [T8-2A](#)
 Wei, W [T12-7A](#), [T12-10A](#), [T12-9B](#)
 Weichard, I [T8-5B](#), [S12-5](#)
 Weiglein, A [T25-14A](#)
 Weiler, S [T16-4A](#)
 Weissbach, S [T7-10A](#)
 Weissmann, D [T3-1C](#)
 Welle, A [T9-1A](#)
 Welzel, G [T27-9C](#)
 Wempe, J [T4-2C](#)
 Wen, J [S30-1](#)
 Wender, M [T7-10B](#)
 Wendlandt, E [T18-5C](#)
 Wendlandt, M [T9-3A](#)
 Wenk, P [T21-6B](#), [T25-11B](#)
 Wenzel, J [T5-1C](#), [T12-6A](#), [T22-7B](#)
 Werchner, Y [T17-5A](#)
 Werner, C [T12-7B](#)
 Wernersbach, I [T12-4A](#)
 Wernet, M [T14-4B](#)
 Wernet, M [S27-3](#)
 Wesch, N [T26-2B](#)
 Weißling, J [T25-14C](#)
 Westendorff, S [T24-6B](#)
 Wetekam, J [T18-7A](#)
 Wetzel, A [T27-8B](#)
 Whitehead, S [T21-7B](#)
 Whiteman, S [S1-1](#)
 Whitney, D [S36-5](#)
 Wicher, D [T19-4B](#)
 Wicke, K [T18-9A](#)
 Wicke, K [T7-7C](#)
 Wickel, J [T12-3B](#)
 Widmann, A [T25-17C](#)
 Wiegert, J [T8-3A](#)
 Wiegert, S [T4-3C](#), [T27-1A](#)
 Wiegert, S [T27-6C](#)
 Wiegrebe, L [T18-5B](#)
 Wieland, L [T11-1A](#)
 Wiesel, E [T19-4B](#)
 Wigger, D [T17-2A](#)
 Wilhelm, I [S15-7](#)
 Wilknitz, P [T17-2B](#)
 Willecke, P [T1-1C](#)
 Williams, Z [T24-6A](#)
 Willig, K [T8-2A](#)

Willis, J [T26-3A](#)
Wilms, H [T11-10B](#)
Wiltfang, J [T11-4A](#)
Windmüller, B [T12-5A](#)
Winhart, V [T18-8C](#)
Winiarski, M [T19-6A](#)
Winkelhoff, J [T7-3C](#)
Winkler, U [T10-3C](#)
Winklhofer, M [S31-4](#)
Winter, C [T13-5C](#)
Winter, Y [S13-5](#), [T23-5C](#)
Wirth, A [T26-4A](#)
Wischmeyer, E [T12-5A](#), [T20-3A](#)
Wissing, C [T27-6C](#)
Wit, C [T2-3C](#)
Wit, C [T2-3B](#)
Witkowska, A [T7-15B](#)
Witte, M [T7-6B](#), [T20-3C](#), [T23-4B](#)
Witte, W [T12-5A](#)
Wittenmayer, N [T7-8C](#)
Witzke, I [S22-2](#)
Wöhner, A [T7-9C](#)
Wolf, B [S13-3](#), [S22-2](#)
Wolf, B [T17-5C](#)
Wolf, F [T23-4A](#), [T23-4C](#), [T25-3B](#), [T26-1B](#), [T26-2B](#)
Wolf, J [T7-10C](#), [T9-2A](#), [T9-4C](#)
Wolff, P [T10-5A](#)
Wong, S [S31-4](#)
Wong Fong Sang, I [T3-2B](#)
Wörgötter, F [S11-3](#)
Wouters, M [T18-1A](#)
Wright, A [T25-1C](#)
Wright, T [T21-7C](#)
Wrobel, C [T17-4A](#)
Wu, S [T12-6C](#)
Wu, Y [S26-3](#)
Wunderlich, F [T22-6A](#)
Wunderlich, T [T22-4C](#)
Wurm, C [T7-6A](#)
Wuttke, T [T6-1A](#)
Wuttke, T [S12-2](#)

Author Index

[A](#) [B](#) [C](#) [D](#) [E](#) [F](#) [G](#) [H](#) [I](#) [J](#) [K](#) [L](#) [M](#) [N](#) [O](#) [P](#) [Q](#) [R](#) [S](#) [T](#) [U](#) [V](#) [W](#) [X](#) [Y](#) [Z](#)

Xia, J [S1-4](#)

Xia, P [S33-4](#)

Xiao, M [T17-6C](#)

Xiao, X [T22-4C](#)

Xin, W [T12-7A](#), [T12-10A](#), [T12-9B](#)

Xu, J [S31-1](#)

Author Index

[A](#) [B](#) [C](#) [D](#) [E](#) [F](#) [G](#) [H](#) [I](#) [J](#) [K](#) [L](#) [M](#) [N](#) [O](#) [P](#) [Q](#) [R](#) [S](#) [T](#) [U](#) [V](#) [W](#) [X](#) [Y](#) [Z](#)

Yagoub, S [T2-1C](#), [T22-5A](#), [T22-5B](#)
Yan, R [T22-10C](#)
Yang, A [T5-2C](#)
Yang, S [T12-1A](#)
Yang, W [S4-1](#)
Yang, X [T1-7A](#)
Yang-Hood, A [T17-6C](#)
Yardley, H [T18-7B](#)
Ye, X [T11-3C](#)
Yeghiazaryan, G [T22-4C](#)
Yellapantula, S [T25-1C](#)
Yeo, J [T13-7A](#)
Yildirim, G [T1-2C](#)
Yildiz, B [S13-4](#)
Yildiz, C [T10-5A](#), [T25-14B](#), [T10-6C](#)
Yildiz, D [T27-8C](#)
Yilmazer-Hanke, D [T10-3B](#)
Yiu, Y [S30-5](#)
Young, M [T15-1A](#)
Yuan, Y [T12-5C](#)
Yuan, Z [S18-2](#)
Yu-Strzelczyk, J [T12-1A](#)
Yvon-Durocher, G [T23-5C](#)

Author Index

[A](#) [B](#) [C](#) [D](#) [E](#) [F](#) [G](#) [H](#) [I](#) [J](#) [K](#) [L](#) [M](#) [N](#) [O](#) [P](#) [Q](#) [R](#) [S](#) [T](#) [U](#) [V](#) [W](#) [X](#) [Y](#) [Z](#)

Zacher, A [T23-10C](#)
Zagrebelsky, M [T7-4C](#), [T12-2C](#), [T25-9C](#)
Zandawala, M [T23-8C](#)
Zandi, S [T9-4A](#), [S15-10](#)
Zapp, S [T15-3B](#)
Zavialov, V [S29-1](#)
Zdravkovic, M [S19-5](#)
Zeitouny, C [T25-15B](#)
Zenobi-Wong, M [S30-3](#)
Zerche, M [S22-2](#), [T27-6A](#)
Zeug, A [T5-2B](#), [T9-6A](#), [T9-3B](#), [T26-4A](#)
Zhang, C [T26-2B](#)
Zhang, H [S35-1](#)
Zhang, J [T2-4C](#), [T23-8A](#)
Zhang, J [T19-2C](#)
Zhang, L [T20-5B](#)
Zhang, X [T17-1B](#)
Zhao, N [T9-7B](#)
Zhao, R [T9-7B](#)
Zheng, F [T7-11A](#), [T7-12A](#), [T7-2C](#), [T13-1B](#)
Zhou, J [T11-3B](#)
Zhu, J [T22-5A](#), [T22-5B](#)
Ziaie Nezhad, F [T25-14C](#)
Ziebarth, T [T4-3C](#), [S29-2](#)
Ziegler, M [T11-8B](#)
Ziegler, R [T25-15C](#)
Ziegler, R [T19-7A](#)
Ziemens, D [T5-1C](#), [T22-7B](#)
Zierenberg, J [S30-4](#)
Zimmer, A [S18-3](#)
Zimmer-Bensch, G [T10-5A](#), [S23-2](#), [T25-14B](#), [T10-6C](#)
Zimmermann, J [S11-5](#)
Zimmermann, K [T20-1A](#)
Zirpel, F [S13-6](#)
Zitelli, K [T27-2B](#)
Zmiskol, F [T8-1C](#)
Zöller, Y [T24-4A](#)
Zolmon, H [T23-1C](#)
Zolnik, T [S3-5](#), [T10-1A](#)
Zrzavy, T [S15-6](#)
Züfle, P [T19-5B](#)
Züfle, P [T2-1B](#)
Zuschratter, W [T27-8B](#)
Zwaka, H [T22-7C](#)
Zyhowski, W [S17-1](#)

